

CATALOGUE / ΚΑΤΑΛΟΓΟΣ

**ELECTRICAL EQUIPMENT**  
ΗΛΕΚΤΡΟΛΟΓΙΚΟ ΥΛΙΚΟ

2026

**EUROLAMP®**



CATALOGUE / ΚΑΤΑΛΟΓΟΣ



**ELECTRICAL EQUIPMENT**  
ΗΛΕΚΤΡΟΛΟΓΙΚΟ ΥΛΙΚΟ

**2026**

**EUROLAMP®**



Η **EUROLAMP** είναι μια συνεχώς αναπτυσσόμενη ελληνική εταιρεία που πρωτοπορεί και καινοτομεί, κάνοντας τη διαφορά εδώ και 27 χρόνια! Πρόκειται για μια δυναμικά εξελισσόμενη εταιρεία με νέα προϊόντα σύγχρονης τεχνολογίας, που ανταποκρίνονται στις απαιτήσεις του σύγχρονου εμπορίου, είναι φιλικά προς το περιβάλλον και συμμορφώνονται με όλους τους ευρωπαϊκούς και διεθνείς κανονισμούς.

Διαθέτει μια ευρεία γκάμα φωτιστικών ARTE ILLUMINA (οικιακής και επαγγελματικής χρήσης), λαμπτήρες, ηλεκτρολογικό εξοπλισμό, χριστουγεννιάτικο φωτισμό και διακόσμηση, κλιματιστικές μονάδες ZEPHYRUS - AERE, ηλεκτρικές συσκευές, μπαταρίες, φωτοβολταϊκά συστήματα LIGHTBORN SYSTEMS, προϊόντα ηλεκτροκίνησης EMOOV (ηλεκτρικά scooters και sea-scooters) καθώς και είδη διακόσμησης ESTHETI.

Διατηρεί αξιόπιστες και μακροχρόνιες συνεργασίες και διαθέτει ένα ισχυρό δίκτυο πωλήσεων με περισσότερα από 3.600 σημεία πώλησης στην Ελλάδα, την Κύπρο και σε περισσότερες από 30 χώρες εντός και εκτός ΕΕ.

### Επένδυση στο μέλλον

Το 2024, η EUROLAMP ολοκλήρωσε επένδυση ύψους 15 εκατομμυρίων ευρώ, φέρνοντας όλες τις δραστηριότητες της εταιρείας σε ένα νέο, σύγχρονο επιχειρηματικό συγκρότημα. Αυτό περιλαμβάνει ένα υπερσύγχρονο κέντρο logistics, νέα γραφεία, εκθεσιακούς χώρους, αναβαθμισμένο τεχνικό και IT εξοπλισμό, τα οποία, σε συνδυασμό με την εμπειρία, την τεχνογνωσία και τις γνώσεις του ανθρώπινου δυναμικού, διασφαλίζουν την άριστη εξυπηρέτηση των πελατών.

### Οι αξίες μας

- Σεβασμός στον πελάτη με συνέπεια και αξιοπιστία
- Προσωπικό και επιχειρηματικό ήθος
- Δημιουργία αδιάρρηκτων σχέσεων με τους συνεργάτες μας
- Καινοτομία και συνεχής εξέλιξη
- Υψηλή ποιότητα προϊόντων και υπηρεσιών
- Εκπαίδευση και ανάπτυξη του προσωπικού



**EUROLAMP** is a constantly growing Greek company that pioneers and innovates, making a difference for 27 years!

Is a constantly evolving company with new products of modern technology that meet the requirements of modern trade, are environmentally friendly and follow all the European and International Legislation rules.

Has a wide variety of lighting products (for domestic and professional use), bulbs, decorative lighting fixtures ARTE ILLUMINA, electrical equipment, Christmas lighting and decoration, air conditioning units ZEPHYRUS - AERE, electrical appliances, batteries, photovoltaics LIGHTBORN SYSTEMS, EMOOV electric scooters and sea-scooters) and home decoration items ESTHETI.

Maintains reliable and long-term partnerships and has a strong sales network with more than 3,600 selling points in Greece, Cyprus and more than 30 countries inside and outside the EU.

### **An investment to the future**

In 2024, EUROLAMP completed a 15 million euros investment, bringing all company's activities into a new modern business complex. This includes a high-end logistics center, new offices, showrooms, upgraded technical and IT equipment, which in combination with the experience, expertise and knowledge of human resources ensure an excellent customer service.

### **Our values**

- Respect with consistency and reliability
- Personal and business ethics
- Creating unbreakable relationships with our partners
- Innovation and continuous development
- High quality products and services
- Continuous investment in human resources

### **EUROLAMP SA GREECE**

3rd km Symmachiki Road.  
57013 Oraiokastro.  
Thessaloniki. Greece  
Tel: +30 2310 574802  
Fax: +30 2310 574919  
Email: info@eurolamp.gr  
www.eurolamp.gr

### **EUROLAMP BELGIUM SRL**

Rue Des Artisans 4B  
6210 - Frasnes Lez Gosselies  
Belgique  
Siège Social +32 (0) 493 444 162 (FR/EN)  
Délégué Wallonie +32 (0) 492 245 612 (FR)  
Email: info@eurolamp.be

### **EUROLAMP SA CHINA**

Rm1101-1106. JiuYou Mansion  
No.1158 Huyi Highway  
Nanxiang Town. Jiading District  
201800 Shanghai / P.R. China  
Tel. +86-21-64379558  
Fax: +86-21-64722682

### **EUROLAMP ITALIA SRL**

via dell'Airone 35  
00169 Roma (RM) ITALIA  
Tel. + 39 06 56546893  
Email: eurolampitalia@eurolampglobal.com  
www.eurolampglobal.com

# Get in touch!

Ελάτε σε επαφή μαζί μας!

Η Eurolamp έχει παρουσία σε μια ποικιλία μέσων κοινωνικής δικτύωσης στα οποία μπορείτε να παρακολουθείτε την εξέλιξη της εταιρείας αλλά κυρίως τα καινοτόμα προϊόντα και λύσεις που διαθέτουμε!

Eurolamp has a presence on a variety of social media where you can follow the development of the company but mainly the innovative products and solutions we can provide to you and to your customers!

**facebook**  **YouTube**  **LinkedIn**  **Instagram**

Σκανάρετε το QR code και βρείτε μας στο κοινωνικό μέσο της επιλογής σας



Scan the QR code and find us on the social media of your choice

# Ανακαλύψτε τη συλλογή μας

Discover our collection

Εξερευνήστε τους πλήρεις καταλόγους με σύγχρονες λύσεις φωτισμού, ηλεκτρολογικό εξοπλισμό, διακοσμητικά είδη, κλιματισμό, φωτοβολταϊκά συστήματα και πολλά ακόμη προϊόντα που συνδυάζουν ποιότητα, καινοτομία και σεβασμό στο περιβάλλον!

Explore our full catalogues featuring modern lighting solutions, electrical equipment, decorative items, air conditioning systems, photovoltaic systems and many more products that combine quality, innovation and environmental responsibility.

Σκανάρετε το QR code και βρείτε τους καταλόγους μας



Scan the QR code and find our catalogues

# Banking Accounts

Τραπεζικοί λογαριασμοί

Στοιχεία τραπεζικών λογαριασμών **EUROLAMP ABEE**  
**EUROLAMP SA** banking accounts

**ΕΘΝΙΚΗ ΤΡΑΠΕΖΑ / NBG:** 224/470122-40  
**IBAN:** GR79 0110 2240 0000 2244 7012 240

**ΤΡΑΠΕΖΑ ΠΕΙΡΑΙΩΣ / PIRAEUS BANK:** 5229-063351-500  
**IBAN:** GR26 0172 2290 0052 2906 3351 500

**ALPHA BANK:** 703 00 2002 016002  
**IBAN:** GR86 0140 7030 7030 0200 2016 002

**EUROBANK:** 0026.0216.91.0200622333  
**IBAN:** GR72 0260 2160 0009 1020 0622 333

Στοιχεία τραπεζικών λογαριασμών Βελγίου **EUROLAMP BELGIUM SPRL**  
**EUROLAMP BELGIUM SPRL** banking accounts

**BENEFICIARY NAME:** EUROLAMP BELGIUM SPRL  
**BENEFICIARY ADDRESS:** Rue Des Artisans 4B  
6210 - Frasnes Lez Gosselies - Belgique  
**BANK:** AXA BANK BELGIUM  
**IBAN ACCOUNT:** BE87751207895894  
**BIC:** AXABBE22

# Certifications

## Πιστοποιήσεις



ISO 14001:2015  
ISO/IEC 27001:2022  
ISO 45001:2018  
ISO 13485:2016



ΥΠΟΥΡΓΙΚΗ ΑΠΟΦΑΣΗ  
ΔΥ86/Γ.Π. ΟΙΚ/1348/2004  
ISO 9001:2015



ISO 37001  
ISO 39001  
ISO 26000:2010



ISO 5001:2018



ΣΥΜΒΟΛΙΚΟ ΣΥΣΤΗΜΑ  
ΕΝΑΝΤΙΚΗΣ ΔΙΑΧΕΙΡΙΣΗΣ ΦΟΡΤΙΩΝ  
ΗΛΕΚΤΡΙΚΩΝ ΣΤΗΛΩΝ



ΦΩΤΟΚΥΚΛΩΣΗ



### Παροχή προϊόντων και υπηρεσιών σύμφωνα με τις κορυφαίες προδιαγραφές και απαιτήσεις ποιότητας

Η προσήλωση της Εταιρείας στην Ποιότητα είναι δεδομένη, αδιαμφισβήτητη και συνοδεύει την καλή της φήμη. Για το λόγο αυτό, η Διοίκηση της Εταιρείας, έχει καθορίσει ως ανώτερο αντικειμενικό σκοπό την αυστηρή εφαρμογή και διατήρηση Ενιαίου Συστήματος Διαχείρισης Ποιότητας, Διαχείρισης Ιατροτεχνολογικού Εξοπλισμού, Περιβαλλοντικής Διαχείρισης, Επιχειρησιακής Συνέχειας, Εταιρικής Κοινωνικής Ευθύνης, Καταπολέμησης της Δωροδοκίας, Διαχείρισης της Οδικής Ασφάλειας, Υγείας & Ασφάλειας στην Εργασία και Διαχείρισης της Ενέργειας, σύμφωνα με τα νέα πρότυπα ISO 9001:2015, ISO 13485:2016, ISO 14001:2015, ISO 22301:2019, ISO 26000:2010, ISO 37001:2016, ISO 39001:2012, ISO 45001:2018 και ISO 50001:2018, καθώς και τη συνεχή βελτίωση, του εν λόγω Ενιαίου Συστήματος.

Η εταιρεία έχοντας εισαχθεί στον κλάδο των βιοκτόνων και ιατροτεχνολογικών προϊόντων λειτουργεί σύμφωνα με το πρότυπο ISO 13485 και την Υ/Α 1348 ώστε να διασφαλίζεται η ασφαλής και ακίνδυνη για την υγεία διανομή των προϊόντων. Πιστοποιημένα προϊόντα για ασφαλή χρήση με βάση την Ευρωπαϊκή και Διεθνή νομοθεσία και εφόσον απαιτείται διαθέτουν έγκριση από τον ΕΟΦ, έγκριση από τον Ευρωπαϊκό Οργανισμό Χημικών Προϊόντων ECHA και καταχώριση στην ευρωπαϊκή βάση δεδομένων συμμορφούμενα με την κοινοτική και εθνική νομοθεσία.

Επίσης, εγκατέστησε ένα σύστημα διαχείρισης ασφάλειας πληροφοριών που είναι σύμφωνο με το πρότυπο ISO/IEC 27001:2022.

Με όραμα την αειφόρο ανάπτυξη δεσμεύεται για την προσπάθεια μείωσης της ενεργειακής κατανάλωσης και των εκπεμπόμενων ρύπων που αφορούν στις δραστηριότητες παραγωγής και εμπορίας ηλεκτρολογικού υλικού στις κεντρικές εγκαταστάσεις της στο Ωραιόκαστρο Θεσσαλονίκης μέσω του συστήματος ενεργειακής διαχείρισης σύμφωνα με το πρότυπο ISO 50001:2018.

### Products supply and services according to the highest quality and specifications requirements

The Company's commitment to Quality is given, indisputable and accompanies its good reputation. For this reason, the Company's Management has determined as a higher objective the strict implementation and maintenance of the Unified Quality Management System, Quality Management System of Medical Devices, Environmental Management System, Business Continuity Management System, Corporate Social Responsibility Management System, Anti-Bribery Management System, Road Safety Management System, Occupational Health and Safety Management System, Energy Management System according to the standards ISO 9001:2015, ISO 13485:2016, ISO 14001:2015, ISO 22301:2019, ISO 26000:2010, ISO 37001:2016, ISO 39001:2012, ISO 45001:2018, ISO 50001:2018, as well as the continuous improvement of the Unified System.

The company having entered in the field of the biocidal products and medical devices products, it operates according to ISO 13485 standard and Ministerial Decision 1348, so as to secure the safe and harmless for health products distribution. It markets certified products for safe use according to European and international law, which have the National Organization for Medicines approval wherever imposed, European Chemicals Agency approval as well as the registration in the European database and are compliant to the European and national legislation.

Additionally the company has installed an information safety system, which is in accordance to ISO/IEC 27001:2022 standard.

With a vision to sustainable development EUROLAMP SA is committed to an effort to limit power consumption and emitted pollutants from production activities and electrological supply trade at our central facilities at Oraiokastro Thessaloniki through the energy management system according to ISO 50001:2018 standard.

Στον κατάλογο μας, σε κάθε κωδικό θα βρείτε και το barcode του. Με την εφαρμογή EUROLAMP B2B μπορείτε να σκανάρετε το barcode που επιθυμείτε και να κάνετε την παραγγελία σας εύκολα και γρήγορα! Ζητήστε μας να σας αποστείλουμε τους κωδικούς πρόσβασης!

Σχεδιασμένη και δομημένη σε πλήρη αρμονία με τη διαδικτυακή πλατφόρμα B2B, έρχεται να συμπληρώσει στο έπακρο όλες τις δυνατότητες που θα θέλατε να έχετε από ένα Ψηφιακό Πολυ-εργαλείο! Εντοπίστε τα προϊόντα που σας ενδιαφέρουν, αναζητήστε νέα προϊόντα, προσφορές και προωθητικές ενέργειες, επαληθεύστε τη διαθεσιμότητα των κωδικών και την ημερομηνία παραλαβής των προϊόντων στις αποθήκες μας, προσθέστε κωδικούς στη παραγγελία σας απλά σκανάροντας το προϊόν και κρατείστε τον έλεγχο των παραγγελιών σας! Όλα αυτά μέσω του κινητού σας!

- Διαθεσιμότητα των προϊόντων
- Ημερομηνία παραλαβής των προϊόντων στις αποθήκες μας
- Καταχώρηση παραγγελίας
- Παρακολούθηση της εξέλιξης της παραγγελίας
- Πρόσβαση σε οικονομικά στοιχεία

Τώρα μπορείτε να έχετε στο κινητό σας όλες τις πληροφορίες που χρειάζεστε άμεσα και εύκολα με ένα scroll! Κατεβάστε τη νέα mobile εφαρμογή EUROLAMP B2B από το App Store (iOS) ή το Play Store (ANDROID). \* Για οποιαδήποτε επιπρόσθετη πληροφορία σχετικά με την εφαρμογή EUROLAMP B2B App παρακαλούμε απευθυνθείτε στον πωλητή που σας εξυπηρετεί.

In our catalog, in each code you will find its barcode. With the EUROLAMP B2B application you can scan the barcode you want and place your order easily and quickly! Ask us to send you the passwords!

Designed and built in complete harmony with the B2B web platform, it comes to fill to the fullest all the possibilities you would like to have from a Digital Multi-tool! availability of codes and the date of receipt of products in our warehouses, add codes to your order simply by scanning the product and keep control of your orders! All this through your mobile!

- Availability of products
- Delivery date of the products in our warehouses
- Order entry
- Monitoring progress of the order
- Access to financial data

Now you can have all the information you need on your mobile phone instantly and easily with one scroll!  
\*Download the new EUROLAMP B2B mobile application from the App Store (iOS) or the Play Store (ANDROID).

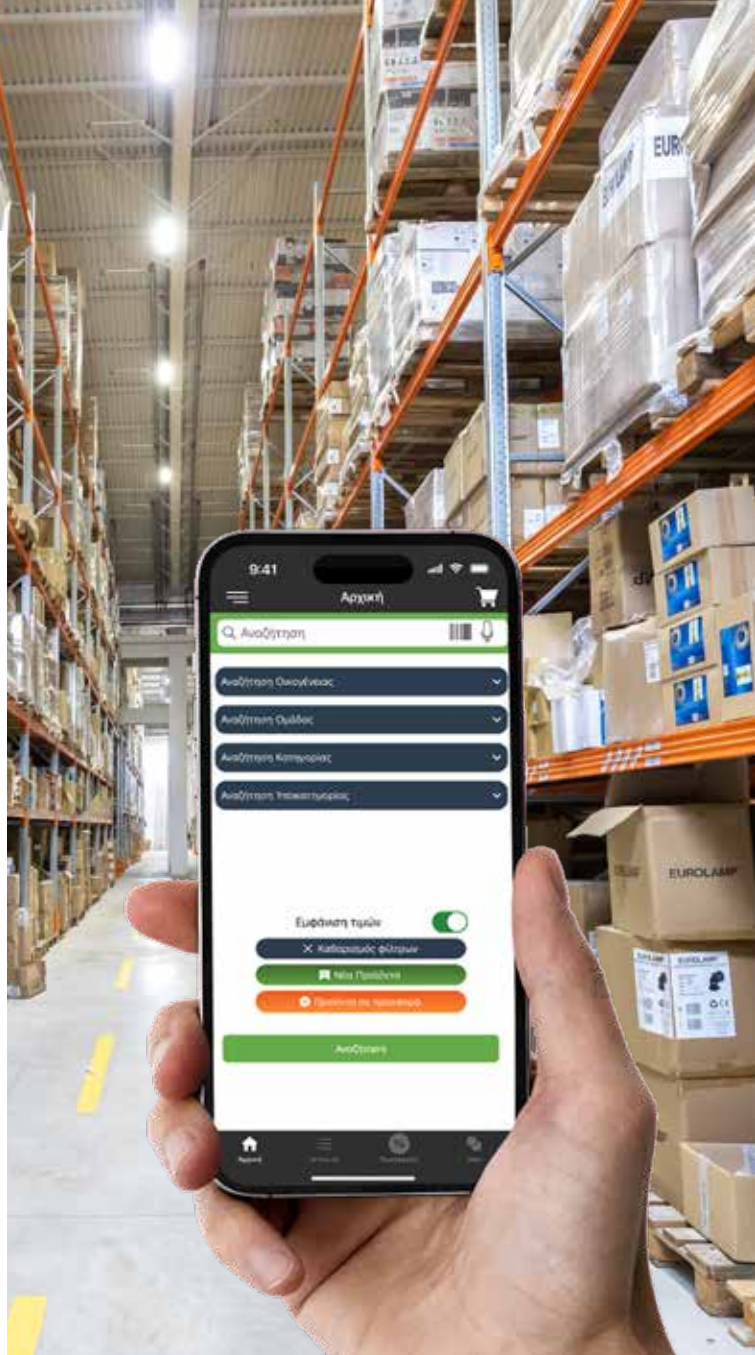

Νέα δυνατότητα  
παραγγελίας μέσω του app

**EUROLAMP B2B**

New ordering feature  
through the app

Download & Install



# Icons Explanation

## Επεξήγηση εικονιδίων



**On-Off Switch**  
Διακόπτης ON-OFF



**Reset Switch**  
Διακόπτης Επαναφοράς



**Function Indicator**  
Φωτεινή Ενδειξη Λειτουργίας



**USB Port**  
Θύρα USB



**Battery Type**  
Τύπος Μπαταρίας



**Material Type**  
Τύπος Υλικού

**Lm/W**  
90

**Lumen/Watt**



**50.000h**

**Life time**  
Διάρκεια Ζωής



**-20 | +40 °C**

**Operating Temperature**  
Θερμοκρασία λειτουργίας



**5 YEARS WARRANTY**

**Years of Guarantee**  
Χρόνια Εγγύησης



**GROUNDING**

**Grounding**  
Γείωση



**MOTION SENSOR**

**Sensor Type**  
Τύπος Αισθητήρα



**OVERHEAT PROTECTION**

**Overheat Protection**  
Προστασία υπερθέρμανσης



**SURGE SAFE JOULES**

**Surge Safe**  
Προστασία υπερφόρτωσης



**SOUND ALARM 85 DB**

**Sound volume**  
Ένταση Ήχου



**TIMER**

**Timer**  
Χρονοδιακόπτης



**CABLE CROSS SECT. 3X1.5mm**

**Cable Cross Section**  
Διατομή Καλωδίου

# Περιεχόμενα

## Contents



**21**

ΗΛΕΚΤΡΟΛΟΓΙΚΟ ΥΛΙΚΟ / ELECTRICAL EQUIPMENT



**41**

UK ΗΛΕΚΤΡΟΛΟΓΙΚΟ ΥΛΙΚΟ / **UK-TYPE** ELECTRICAL EQUIPMENT



**45**

ΚΤΙΡΙΑΚΟΣ ΕΞΟΠΛΙΣΜΟΣ / BUILDING EQUIPMENT



**59**

ΕΠΑΓΓΕΛΜΑΤΙΚΟΣ ΕΞΟΠΛΙΣΜΟΣ ΜΠΑΝΙΟΥ / PROFESSIONAL BATHROOM EQUIPMENT



**63**

ΕΡΓΑΛΕΙΑ / TOOLS



**67**

ΑΝΑΛΩΣΙΜΟ ΗΛΕΚΤΡΟΛΟΓΙΚΟ ΥΛΙΚΟ / ELECTRICAL CONSUMABLES



**79**

ΥΛΙΚΑ ΦΩΤΙΣΤΙΚΩΝ / LIGHTING HARDWARE



**85**

ΑΝΑΛΩΣΙΜΟ ΥΛΙΚΟ / CONSUMABLES



**97**

ΚΑΛΩΔΙΑ / CABLES



**103**

ΠΙΝΑΚΕΣ / DIN RAIL ENCLOSURES



**123**

ΔΙΑΚΟΠΤΕΣ / WALL MOUNTED SWITCHES



**127**

ΑΣΦΑΛΕΙΕΣ / PORCELAIN FUSES

**GACIA**

**131**

GACIA ELECTRICAL

**EUROLAMP**  
Smart

**173**

ΕΞΥΠΝΟ ΣΠΙΤΙ / SMART HOME



**179**

ΕΥΡΕΤΗΡΙΟ ΚΩΔΙΚΩΝ / CODE INDEX

ΦΙΣ ΡΕΥΜΑΤΟΣ  
ΑΝΤΑΠΤΟΡΕΣ  
POWER PLUGS  
ADAPTER



ΦΙΣ ΔΙΠΟΛΙΚΟ ΑΡΣΕΝΙΚΟ  
PLUG 2 POLE  
NORMAL MALE  
24



ΦΙΣ ΔΙΠΟΛΙΚΟ ΘΗΛΥΚΟ  
PLUG 2 POLE  
NORMAL FEMALE  
24



ΦΙΣ ΣΟΥΚΟ ΑΡΣΕΝΙΚΟ Τ.Λ.  
ME ΠΡΟΣΤΑΣΙΑ ΕΠΑΦΩΝ  
PLUG SCHUKO MALE T.L.  
WITH SHUTTER  
PROTECTION  
24



ΦΙΣ ΣΟΥΚΟ ΘΗΛΥΚΟ Τ.Λ.  
ME ΠΡΟΣΤΑΣΙΑ ΕΠΑΦΩΝ  
PLUG SCHUKO FEMALE  
T.L. WITH SHUTTER  
PROTECTION  
24



ΦΙΣ ΣΟΥΚΟ ΑΡΣΕΝΙΚΟ  
ΠΛΑΓΙΑΣ  
PLUG SCHUKO MALE  
RIGHT ANGLE  
24



ΦΙΣ ΣΟΥΚΟ ΑΡΣΕΝΙΚΟ  
SLIM ΠΛΑΓΙΑΣ  
PLUG SCHUKO FEMALE  
SLIM RIGHT ANGLE  
25



ΦΙΣ ΣΟΥΚΟ ΚΑΟΥΤΣΟΥΚ  
ΑΡΣΕΝΙΚΟ  
PLUG SCHUKO  
RUBBER MALE  
25



ΦΙΣ ΣΟΥΚΟ ΚΑΟΥΤΣΟΥΚ  
ΘΗΛΥΚΟ  
PLUG SCHUKO  
RUBBER FEMALE  
25



ΑΝΤΑΠΤΟΡΑΣ  
1/3 ΣΟΥΚΟ ΟΒΑΛ  
ADAPTER 1/3  
SCHUKO OVAL  
26



ΑΝΤΑΠΤΟΡΑΣ 1/3 ΣΟΥΚΟ  
ΣΤΑΥΡΟΣ ΟΡΙΖΟΝΤΙΟ  
ADAPTER 1/3 SCHUKO  
CROSS HORIZONTAL  
26



ΑΝΤΑΠΤΟΡΑΣ 1/2  
ΣΟΥΚΟ ΤΑΦ  
ADAPTER 1/2 SCHUKO 'T'  
26



ΑΝΤΑΠΤΟΡΑΣ 1/3 ΣΟΥΚΟ  
ΣΤΑΥΡΟΣ ΚΑΘΕΤΟ  
ADAPTER 1/3 SCHUKO  
CROSS VERTICAL  
26



ΑΝΤΑΠΤΟΡΑΣ 1/1 ΣΟΥΚΟ  
ME ΔΙΑΚΟΠΤΗ  
ADAPTER 1/1 SCHUKO  
WITH SWITCH  
27



ΑΝΤΑΠΤΟΡΑΣ 1/2 ΣΟΥΚΟ  
ME ΔΙΑΚΟΠΤΗ  
ADAPTER 1/2 SCHUKO  
WITH SWITCH  
27



ΑΝΤΑΠΤΟΡΑΣ 1/3 ΣΟΥΚΟ  
ME ΔΙΑΚΟΠΤΗ  
1/3 SCHUKO WITH SWITCH  
27



ΠΡΙΖΑ ΣΟΥΚΟ  
ΤΗΛΕΧΕΙΡΙΣΤΗΡΙΟ &  
ΠΡΟΣΤΑΣΙΑ ΕΠΑΦΩΝ  
SCHUKO SOCKET REMOTE  
& SHUTTER PROTECTION  
27



ΑΝΤΑΠΤΟΡΑΣ 1 ΣΟΥΚΟ ΣΕ  
2 ΑΠΛΑ ΔΙΠΟΛΙΚΑ  
1 SCHUKO TO 2 NORMAL  
28



ΑΝΤΑΠΤΟΡΑΣ 1 ΣΟΥΚΟ ΣΕ  
3 ΑΠΛΑ ΔΙΠΟΛΙΚΑ  
1 SCHUKO TO 3 NORMAL  
28



ΑΝΤΑΠΤΟΡΑΣ 1/1 ΣΟΥΚΟ  
ΣΕ 2 ΔΙΠΟΛΙΚΑ  
1/1 SCHUKO TO 2 NORMAL  
28



ΑΝΤΑΠΤΟΡΑΣ 1/2 ΣΟΥΚΟ  
1/2 SCHUKO  
28



ΑΝΤΑΠΤΟΡΑΣ ΣΟΥΚΟ ME  
ΠΡΟΣΤΑΣΙΑ ΥΠΕΡΤΑΣΗΣ &  
ΕΠΑΦΩΝ  
SCHUKO SURGE & SHUT-  
TER PROTECTION  
29



ΑΝΤΑΠΤΟΡΑΣ ΣΟΥΚΟ ME  
ΠΡΟΣΤΑΣΙΑ ΥΠΕΡΤΑΣΗΣ &  
ΕΠΑΦΩΝ  
SCHUKO SURGE & SHUT-  
TER PROTECTION  
29



ΑΝΤΑΠΤΟΡΑΣ ΣΟΥΚΟ  
ME 2 ΘΥΡΕΣ USB  
SCHUKO WITH 2 USB  
PORTS  
29



ΑΝΤΑΠΤΟΡΑΣ ΣΟΥΚΟ  
TYPE C & TYPE A  
ΘΥΡΕΣ USB  
SCHUKO TYPE C & TYPE A  
USB PORTS  
29



ΚΑΛΑΘΙ PROMO  
EUROLAMP  
EUROLAMP PROMO  
BASKET  
28

ΒΙΟΜΗΧΑΝΙΚΟΥ  
ΤΥΠΟΥ  
ΦΙΣ & ΠΡΙΖΕΣ  
INDUSTRIAL  
PLUGS &  
SOCKETS



ΦΙΣ ΑΡΣΕΝΙΚΑ  
ΒΙΟΜΗΧΑΝΙΚΟΥ ΤΥΠΟΥ  
INDUSTRIAL TYPE  
MALE PLUGS  
30



ΦΙΣ ΘΗΛΥΚΑ  
ΒΙΟΜΗΧΑΝΙΚΟΥ ΤΥΠΟΥ  
INDUSTRIAL TYPE  
FEMALE PLUGS  
30



ΠΡΙΖΕΣ ΕΠΙΤΟΙΧΙΕΣ  
ΒΙΟΜΗΧΑΝΙΚΟΥ ΤΥΠΟΥ  
INDUSTRIAL TYPE WALL  
MOUNTED SOCKETS  
30

ΠΡΟΕΚΤΑΣΕΙΣ  
EXTENSION  
CORDS



ΠΡΟΕΚΤΑΣΗ ΔΙΠΟΛΙΚΗ  
ME ΠΡΟΣΤΑΣΙΑ ΕΠΑΦΩΝ  
EXTENSION CORD BIPOLAR  
WITH SHUTTER PROTECTION  
31



ΠΡΟΕΚΤΑΣΗ ΚΑΛΩΔΙΟΥ  
ΣΟΥΚΟ ME ΠΡΟΣΤΑΣΙΑ  
ΕΠΑΦΩΝ  
EXTENSION CORD SCHUKO  
WITH SHUTTER PROTECTION  
31



ΣΤΕΓΑΝΗ ΠΡΟΕΚΤΑΣΗ ΣΟΥΚΟ  
ME ΠΡΟΣΤΑΣΙΑ ΕΠΑΦΩΝ  
WATERPROOF SCHUKO  
EXTENSION CORD WITH  
SHUTTER PROTECTION  
31



ΑΞΕΣΟΥΑΡ ΤΥΛΙΣΗΣ  
ΠΡΟΕΚΤΑΣΕΩΝ  
HANGER FOR  
EXTENSION CORD  
31

<p>ΠΟΛΥΠΡΙΖΑ MULTI-SOCKETS</p>							
	<p>ΠΟΛΥΠΡΙΖΟ ΣΠΑΣΤΟ ΚΑΛΩΔΙΟ, ΔΙΑΚΟΠΤΗ &amp; ΠΡΟΣΤ. ΕΠΑΦΩΝ FOLDABLE POWER STRIP CORD, SWITCH &amp; SOCKET PROTECTION</p> <p>32</p>	<p>ΠΟΛΥΠΡΙΖΑ ΣΟΥΚΟ ΜΕ ΠΡΟΣΤΑΣΙΑ ΕΠΑΦΩΝ SCHUKO SOCKET WITH SHUTTER PROTECTION</p> <p>34</p>	<p>ΠΟΛΥΠΡΙΖΑ ΣΟΥΚΟ ΜΕ ΠΡΟΣΤΑΣΙΑ ΕΠΑΦΩΝ &amp; ΔΙΑΚΟΠΤΗ SCHUKO SOCKET SHUTTER PROTECTION &amp; SWITCH</p> <p>34</p>	<p>ΠΟΛΥΠΡΙΖΑ ΥΠΕΡΤΑΣΗΣ ΚΑΛΩΔΙΟ, ΠΡΟΣΤΑΣΙΑ ΕΠΑΦΩΝ &amp; ΔΙΑΚΟΠΤΗ SURGE PROTECTED POWER STRIP CORD, SWITCH &amp; SOCKET PROTECT</p> <p>33</p>	<p>ΠΟΛΥΠΡΙΖΑ ΣΟΥΚΟ ΜΕ ΠΡΟΣΤΑΣΙΑ ΕΠΑΦΩΝ SCHUKO SOCKET SHUTTER PROTECTION</p> <p>34</p>	<p>ΠΟΛΥΠΡΙΖΑ ΣΟΥΚΟ ΜΕ ΠΡΟΣΤΑΣΙΑ ΕΠΑΦΩΝ &amp; ΔΙΑΚΟΠΤΗ SCHUKO SOCKET SHUTTER PROTECTION &amp; SWITCH</p> <p>35</p>	
							
	<p>ΠΟΛΥΠΡΙΖΑ ΣΟΥΚΟ ΜΕ ΠΡΟΣΤΑΣΙΑ ΕΠΑΦΩΝ &amp; ΔΙΑΚΟΠΤΗ SCHUKO SOCKET WITH SHUT. PROTECTION &amp; SWITCH</p> <p>35</p>	<p>ΠΟΛΥΠΡΙΖΑ ΣΟΥΚΟ ΜΕ ΠΡΟΣΤΑΣΙΑ ΕΠΑΦΩΝ &amp; ΔΙΑΚΟΠΤΗ SCHUKO SOCKET SHUTTER PROTECTION &amp; SWITCH</p> <p>35</p>	<p>ΠΟΛΥΠΡΙΖΑ ΣΟΥΚΟ ΧΩΡΙΣ ΚΑΛΩΔΙΟ ΜΕ ΠΡΟΣΤΑΣΙΑ ΕΠΑΦΩΝ SCHUKO SOCKET WITHOUT CABLE &amp; SHUTTER PROTECT.</p> <p>36</p>	<p>ΠΟΛΥΠΡΙΖΑ ΣΟΥΚΟ ΧΩΡΙΣ ΚΑΛΩΔΙΟ ΜΕ ΠΡΟΣΤΑΣΙΑ ΕΠΑΦΩΝ &amp; ΔΙΑΚΟΠΤΗ SCHUKO SOCKET WITHOUT CABLE &amp; SHUTTER PROTECT. &amp; SWITCH</p> <p>36</p>	<p>ΠΟΛΥΠΡΙΖΑ ΥΠΕΡΤΑΣΗΣ ΚΑΛΩΔΙΟ, ΠΡΟΣΤΑΣΙΑ ΕΠΑΦΩΝ &amp; ΔΙΑΚΟΠΤΗ SURGE PROTECTED POWER STRIP CORD, SWITCH &amp; SOCKET PROTECT</p> <p>36</p>	<p>ΠΡΙΖΑ ΕΞΩΤΕΡΙΚΗ ΚΑΟΥΤΣΟΥΚ ΜΟΝΗ SCHUKO SOCKET WITH RUBBER COVER SINGLE</p> <p>37</p>	<p>ΠΟΛΥΠΡΙΖΑ ΣΟΥΚΟ ΣΤΕΓΑΝΑ ΚΑΟΥΤΣΟΥΚ ΧΩΡΙΣ ΚΑΛΩΔΙΟ SCHUKO SOCKET WITH RUBBER COVER WITHOUT CABLE</p> <p>36</p>
							
	<p>ΠΟΛΥΠΡΙΖΑ ΣΟΥΚΟ ΣΤΕΓΑΝΑ ΜΕ ΠΡΟΣΤΑΣΙΑ ΕΠΑΦΩΝ &amp; ΔΙΑΚΟΠΤΗ WATER PROOF SCHUKO SOCKET WITH SHUTTER PROTECTION &amp; SWITCH</p> <p>37</p>	<p>ΠΟΛΥΠΡΙΖΟ ΣΟΥΚΟ ΜΕ ΚΑΛΩΔΙΟ &amp; ΠΡΟΣΤΑΣΙΑ ΕΠΑΦΩΝ SCHUKO SOCKET WITH CABLE &amp; SHUTTER PROTECT</p> <p>36</p>	<p>ΠΟΛΥΠΡΙΖΟ ΣΟΥΚΟ ΜΕ ΚΑΛΩΔΙΟ, ΠΡΟΣΤΑΣΙΑ ΕΠΑΦΩΝ &amp; ΔΙΑΚΟΠΤΗ SCHUKO SOCKET, CABLE, SHUT. PROTECT. &amp; SWITCH</p> <p>36</p>				
<p>ΜΠΑΛΑΝΤΕΖΕΣ EXTENSION CABLES</p>							
	<p>ΒΟΞ ΣΤΕΓΑΝΟΠΟΙΗΣΗΣ ΓΙΑ ΣΟΥΚΟ ΦΙΣ SEALING WATERPROOF BOX FOR SCHUKO</p> <p>37</p>	<p>ΜΠΑΛΑΝΤΕΖΑ ΣΥΝΕΡΓΕΙΟΥ ΜΕ ΚΑΛΩΔΙΟ &amp; ΔΙΑΚΟΠΤΗ WORKING LAMP CABLE EXTENSION &amp; SWITCH</p> <p>37</p>	<p>ΜΠΑΛΑΝΤΕΖΑ ΜΕ ΠΡΟΣΤΑΣΙΑ ΥΠΕΡΘΕΡΜΑΝΣΗΣ &amp; ΕΠΑΦΩΝ CABLE REEL WITH OVERHEAT &amp; SHUTTER PROTECTION</p> <p>37</p>	<p>ΜΠΑΛΑΝΤΕΖΑ ΜΕ ΠΡΟΣΤΑΣΙΑ ΥΠΕΡΘΕΡΜΑΝΣΗΣ &amp; ΕΠΑΦΩΝ CABLE REEL WITH OVERHEAT &amp; SHUTTER PROTECTION</p> <p>38</p>	<p>ΜΠΑΛΑΝΤΕΖΑ ΚΑΡΟΥΛΙ ΜΕ ΠΡΟΣΤ. ΥΠΕΡΘΕΡΜΑΝΣΗΣ &amp; ΕΠΑΦΩΝ CABLE REEL COIL WITH OVERHEAT &amp; SHUTTER PROTECT. WITHOUT CABLE</p> <p>38</p>	<p>ΜΠΑΛΑΝΤΕΖΑ ΚΑΡΟΥΛΙ ΜΕ ΠΡΟΣΤ. ΥΠΕΡΘΕΡΜΑΝΣΗΣ &amp; ΕΠΑΦΩΝ ΧΩΡΙΣ ΚΑΛΩΔΙΟ CABLE REEL COIL WITH OVERHEAT &amp; SHUTTER PROTECT. WITH CABLE</p> <p>38</p>	
							
	<p>ΜΠΑΛΑΝΤΕΖΑ ΚΑΡΟΥΛΙ ΜΕ ΠΡΟΣΤ. ΥΠΕΡΘΕΡΜΑΝΣΗΣ &amp; ΕΠΑΦΩΝ CABLE REEL COIL WITH OVERHEAT &amp; SHUTTER PROTECTION</p> <p>38</p>	<p>ΜΠΑΛΑΝΤΕΖΑ ΚΑΡΟΥΛΙ ΜΕ ΠΡΟΣΤ. ΥΠΕΡΘΕΡΜΑΝΣΗΣ &amp; ΕΠΑΦΩΝ CABLE REEL COIL WITH OVERHEAT &amp; SHUTTER PROTECTION</p> <p>39</p>	<p>ΜΠΑΛΑΝΤΕΖΑ ΚΑΡΟΥΛΙ ΜΕ ΠΡΟΣΤ. ΥΠΕΡΘΕΡΜΑΝΣΗΣ &amp; ΕΠΑΦΩΝ CABLE REEL COIL WITH OVERHEAT &amp; SHUTTER PROTECTION</p> <p>39</p>	<p>ΜΠΑΛΑΝΤΕΖΑ ΚΑΡΟΥΛΙ ΜΕ ΠΡΟΣΤ. ΥΠΕΡΘΕΡΜΑΝΣΗΣ &amp; ΕΠΑΦΩΝ CABLE REEL COIL WITH OVERHEAT &amp; SHUTTER PROTECTION</p> <p>39</p>	<p>ΜΠΑΛΑΝΤΕΖΑ ΚΑΡΟΥΛΙ ΜΕ ΠΡΟΣΤ. ΥΠΕΡΘΕΡΜΑΝΣΗΣ &amp; ΕΠΑΦΩΝ CABLE REEL COIL WITH OVERHEAT &amp; SHUTTER PROTECTION</p> <p>39</p>	<p>ΓΙΡΛΑΝΤΑ ΕΞΩΤΕΡΙΚΟΥ ΧΩΡΟΥ ΜΕ 10 ΝΤΟΥΛΙ OUTDOOR STRING LIGHT WITH 10 LAMP HOLDERS</p> <p>40</p>	<p>ΓΙΡΛΑΝΤΑ ΕΞΩΤΕΡΙΚΟΥ ΧΩΡΟΥ ΜΕ 20 ΝΤΟΥΛΙ OUTDOOR STRING LIGHT WITH 20 LAMP HOLDERS</p> <p>40</p>
							
	<p>ΦΙΣ ΡΕΥΜΑΤΟΣ ΑΡΣΕΝΙΚΟ ΤΥΠΟΥ UK PLUG NORMAL MALE UK TYPE</p> <p>42</p>	<p>ΦΙΣ ΡΕΥΜΑΤΟΣ ΘΗΛΥΚΟ ΤΥΠΟΥ UK PLUG NORMAL FEMALE UK TYPE</p> <p>42</p>	<p>ΑΝΤΑΠΤΟΡΑΣ ΑΠΟ UK ΣΕ ΣΟΥΚΟ ΜΕ ΠΡΟΣΤ. ΕΠΑΦΩΝ ADAPTER UK TO SCHUKO WITH SHUT. PROTECTION</p> <p>42</p>	<p>ΧΡΟΝΟΔΙΑΚΟΠΤΗΣ ΠΡΙΖΑΣ ΤΥΠΟΥ UK TIMER SWITCH UK TYPE</p> <p>42</p>	<p>ΤΑΞΙΔΙΩΤΙΚΟΣ ΑΝΤΑΠΤΟΡΑΣ ΑΠΟ ΣΟΥΚΟ ΣΕ UK ΜΕ ΠΡΟΣΤΑΣΙΑ ΕΠΑΦΩΝ TRAVEL ADAPTER SCHUKO TO UK WITH SHUTTER PROTECTION</p> <p>42</p>	<p>ΑΝΤΑΠΤΟΡΑΣ UK 3 ΘΕΣΕΩΝ ΜΕ ΠΡΟΣΤΑΣΙΑ ΕΠΑΦΩΝ ADAPTER UK 3 Sockets WITH SHUTTER PROTECTION</p> <p>42</p>	

UK ΤΥΠΟΙ  
UK TYPES



ΑΝΤΑΠΤΟΡΑΣ ΑΠΟ UK  
ΣΕ ΔΙΠΛΟΚΟ  
ADAPTER UK TO TYPE C  
43



ΑΝΤΑΠΤΟΡΑΣ ΑΠΟ UK  
ΣΕ ΣΟΥΚΟ  
ADAPTER UK TO SCHUKO  
43



ΠΟΛΥΠΡΙΖΟ UK ΜΕ  
ΠΡΟΣΤΑΣΙΑ ΕΠΑΦΩΝ  
UK MULTI-SOCKET WITH  
SHUTTER PROTECTION  
43



ΠΟΛΥΠΡΙΖΟ UK ΜΕ  
ΠΡΟΣΤΑΣΙΑ ΕΠΑΦΩΝ &  
ΔΙΑΚΟΠΤΕΣ  
UK MULTI-SOCKET WITH  
SHUTTER PROTECTION &  
SWITCHES  
43



ΠΟΛΥΠΡΙΖΟ UK ΜΕ  
ΠΡΟΣΤ. ΕΠΑΦΩΝ & ΠΡΟΣΤ.  
ΥΠΕΡΤΑΣΗΣ  
UK MULTI-SOCKET WITH  
SHUTTER PROTECTION &  
SURGE PROTECTION  
43



ΠΡΟΕΚΤΑΣΗ UK ΜΕ  
ΠΡΟΣΤΑΣΙΑ ΕΠΑΦΩΝ  
EXTENSION UK WITH  
SHUTTER  
PROTECTION  
44



ΜΠΑΛΑΝΤΕΖΑ UK ΜΕ  
ΠΡΟΣΤΑΣΙΑ ΥΠΕΡΘΕΡΜ.  
& ΕΠΑΦΩΝ  
UK CABLE REEL WITH OVER  
HEAT & SHUT. PROTECTION  
44



ΜΠΑΛΑΝΤΕΖΑ ΚΑΡΟΥΛΙ  
UK ΜΕ ΠΡΟΣΤΑΣΙΑ  
ΥΠΕΡΘΕΡΜ. & ΕΠΑΦΩΝ  
UK CABLE REEL WITH OVER  
HEAT & SHUT. PROTECTION  
44



ΑΞΕΣΟΥΑΡ ΤΥΛΙΗΣ  
ΠΡΟΕΚΤΑΣΕΩΝ  
HANGER FOR  
EXTENSION CORD  
44

ΑΝΙΧΝΕΥΤΕ  
ΚΙΝΗΣΗΣ &  
ΠΑΡΟΥΣΙΑΣ  
MOTION &  
PRESENCE  
DETECTORS



ΑΝΙΧΝΕΥΤΗΣ ΚΙΝΗΣΗΣ  
ΥΠΕΡΥΘΡΩΝ  
INFRARED MOTION  
DETECTOR  
46



ΑΝΙΧΝΕΥΤΗΣ ΚΙΝΗΣΗΣ  
ΥΠΕΡΥΘΡΩΝ  
INFRARED MOTION  
DETECTOR  
46



ΑΝΙΧΝΕΥΤΗΣ ΚΙΝΗΣΗΣ  
ΥΠΕΡΥΘΡΩΝ ΟΡΟΦΗΣ  
CEILING INFRARED  
MOTION DETECTOR  
46



ΑΝΙΧΝΕΥΤΗΣ ΚΙΝΗΣΗΣ  
ΥΠΕΡΥΘΡΩΝ ΟΡΟΦΗΣ  
CEILING INFRARED  
MOTION DETECTOR  
46



ΑΝΙΧΝΕΥΤΗΣ ΚΙΝΗΣΗΣ  
ΥΠΕΡΥΘΡΩΝ ΧΩΝΕΥΤΟΣ  
INFRARED RECESSED  
MOTION DETECTOR  
46



ΑΝΙΧΝΕΥΤΗΣ ΚΙΝΗΣΗΣ  
ΥΠΕΡΥΘΡΩΝ ΧΩΝΕΥΤΟΣ  
INFRARED RECESSED  
MOTION DETECTOR  
47



ΑΝΙΧΝΕΥΤΗΣ ΚΙΝΗΣΗΣ  
ΥΠΕΡΥΘΡΩΝ ΜΙΚΡΩΝ  
ΑΠΟΣΤΑΣΕΩΝ  
INFRARED RECESSED  
MOVEMENT DETECTOR  
SHORT DISTANCES  
47



ΑΝΙΧΝΕΥΤΗΣ  
ΠΑΡΟΥΣΙΑΣ ΥΠΕΡΥΘΡΩΝ  
ΕΞΩΤΕΡΙΚΟΣ  
INFRARED SURFACE  
PRESENCE SENSOR  
48



ΑΝΙΧΝΕΥΤΗΣ  
ΠΑΡΟΥΣΙΑΣ ΥΠΕΡΥΘΡΩΝ  
ΕΞΩΤΕΡΙΚΟΣ  
INFRARED SURFACE  
PRESENCE SENSOR  
48



ΑΝΙΧΝΕΥΤΗΣ  
ΠΑΡΟΥΣΙΑΣ ΥΠΕΡΥΘΡΩΝ  
ΕΞΩΤΕΡΙΚΟΣ  
INFRARED SURFACE  
PRESENCE SENSOR  
48



ΑΝΙΧΝΕΥΤΗΣ  
ΠΑΡΟΥΣΙΑΣ ΥΠΕΡΥΘΡΩΝ  
ΧΩΝΕΥΤΟΣ  
INFRARED RECESSED  
PRESENCE SENSOR  
48



ΑΝΙΧΝΕΥΤΗΣ  
ΠΑΡΟΥΣΙΑΣ ΥΠΕΡΥΘΡΩΝ  
ΧΩΝΕΥΤΟΣ  
INFRARED RECESSED  
PRESENCE SENSOR  
49



ΑΝΙΧΝΕΥΤΗΣ ΠΑΡΟΥΣΙΑΣ  
ΕΞΩΤΕΡΙΚΟΣ ΜΕ ΤΕΧΝΟΛΟΓΙΑ  
ΜΙΚΡΟΚΥΜΑΤΩΝ  
PRESENCE SENSOR SURFACE  
WITH MICROWAVE  
TECHNOLOGY  
49



ΑΝΙΧΝΕΥΤΗΣ  
ΠΑΡΟΥΣΙΑΣ ΥΠΕΡΥΘΡΩΝ  
ΧΩΝΕΥΤΟΣ  
INFRARED RECESSED  
PRESENCE SENSOR  
49

ΦΩΤΟΚΥΤΤΑΡΑ  
PHOTOSHELL  
SWITCHES



ΦΩΤΟΚΥΤΤΑΡΟ  
ΜΕΡΑΣ-ΝΥΧΤΑΣ  
PHOTOCELL SWITCH  
DAY-NIGHT  
50



ΦΩΤΟΚΥΤΤΑΡΟ  
ΜΕΡΑΣ-ΝΥΧΤΑΣ  
PHOTOCELL SWITCH  
DAY-NIGHT  
50



ΦΩΤΟΚΥΤΤΑΡΟ  
ΜΕΡΑΣ-ΝΥΧΤΑΣ  
PHOTOCELL SWITCH  
DAY-NIGHT  
50

























ΦΩΤΟΚΥΤΤΑΡΟ  
ΜΕΡΑΣ-ΝΥΧΤΑΣ  
PHOTOCELL SWITCH  
DAY-NIGHT  
50



ΦΩΤΟΚΥΤΤΑΡΟ  
ΜΕΡΑΣ-ΝΥΧΤΑΣ  
PHOTOCELL SWITCH  
DAY-NIGHT  
50



ΦΩΤΟΚΥΤΤΑΡΟ ΡΑΓΑΣ  
ΜΕ ΚΑΛΩΔΙΟ  
PHOTOCELL DIN RAIL  
SWITCH DAY-NIGHT WITH  
CABLE  
51

<p>ΦΩΤΟΚΥΤΤΑΡΑ PHOTOSHELL SWITCHES</p>	 <p><b>ΦΩΤΟΚΥΤΤΑΡΟ ΧΡΟΝΙΚΟ ΜΕΡΑΣ-ΝΥΧΤΑΣ</b> PHOTOCELL SWITCH DAY-NIGHT WITH TIMER 51</p>						
<p>ΑΝΙΧΝΕΥΤΕΣ ΚΑΠΝΟΥ SMOKE DETECTORS</p>	 <p><b>ΑΝΙΧΝΕΥΤΗΣ ΚΑΠΝΟΥ ΑΥΤΟΝΟΜΟΣ</b> SMOKE ALARM AUTONOMOUS 52</p>  <p><b>ΑΝΙΧΝΕΥΤΗΣ ΜΟΝΟΞΕΙΔΙΟΥ ΤΟΥ ΑΝΘΡΑΚΑ ΑΥΤΟΝΟΜΟΣ</b> CARBON MONOXIDE DE- TECTOR AUTONOMOUS 52</p>  <p><b>ΑΣΥΡΜΑΤΟΣ ΑΝΙΧΝΕΥΤΗΣ ΚΑΠΝΟΥ SMART HOME</b> WIRELESS HOME SMOKE DETECTOR 52</p>						
<p>ΚΟΥΔΟΥΝΙΑ DOORBELLS</p>	 <p><b>ΚΟΥΔΟΥΝΙ 220-240V</b> DOORBELL 220-240V SOUNDS 53</p>  <p><b>ΚΟΥΔΟΥΝΙ 12V</b> DOORBELL 12V SOUND 53</p>  <p><b>ΚΟΥΔΟΥΝΙ ΗΧΟΥ ΑΣΥΡΜΑΤΟ ΜΠΑΤΑΡΙΑΣ</b> WIRELESS DOORBELL BATTERY 53</p>  <p><b>ΚΟΥΔΟΥΝΙ ΗΧΟΥ ΑΣΥΡΜΑΤΟ ΠΡΙΖΑΣ</b> WIRELESS DOORBELL SOCKET 53</p>						
<p>ΧΡΟΝΟΔΙΑΚΟΠΤΕΣ ΡΕΥΜΑΤΟΣ ELECTRIC TIMER SWITCHES</p>	 <p><b>ΧΡΟΝΟΔΙΑΚΟΠΤΗΣ ΕΞΩΤΕΡΙΚΟΣ</b> TIMER SWITCH SURFACE MOUNTED 54</p>  <p><b>ΧΡΟΝΟΔΙΑΚΟΠΤΗΣ ΠΡΙΖΑΣ 24 ΩΡΩΝ</b> TIMER SWITCH 24HOURS 54</p>  <p><b>ΧΡΟΝΟΔΙΑΚΟΠΤΗΣ ΠΡΙΖΑΣ 24 ΩΡΩΝ</b> TIMER SWITCH 24HOURS 54</p>						
<p>ΘΕΡΜΟΣΤΑΤΕΣ THERMOSTATS</p>	 <p><b>ΘΕΡΜΟΣΤΑΤΗΣ ΘΕΡΜΟΣΙΦΩΝΟΥ</b> WATER HEATER THERMOSTAT 55</p>  <p><b>ΘΕΡΜΟΣΤΑΤΗΣ ΘΕΡΜΟΣΙΦΩΝΟΥ ΚΟΥΜΠΩΤΟΣ</b> WATER HEATER THERMOSTAT BUTTONED 55</p>  <p><b>ΜΗΧΑΝΙΚΟΣ ΘΕΡΜΟΣΤΑΤΗΣ ΧΩΡΟΥ</b> MECHANICAL INDOOR THERMOSTAT 55</p>  <p><b>ΕΒΔΟΜΑΔΙΑΙΟΣ ΨΗΦΙΑΚΟΣ ΘΕΡΜΟΣΤΑΤΗΣ ΧΩΡΟΥ</b> WEEKLY DIGITAL INDOOR THERMOSTAT 56</p>  <p><b>ΕΒΔΟΜΑΔΙΑΙΟΣ ΨΗΦΙΑΚΟΣ ΘΕΡΜΟΣΤΑΤΗΣ ΧΩΡΟΥ</b> WEEKLY DIGITAL INDOOR THERMOSTAT 56</p>						
 <p><b>ΕΒΔΟΜΑΔΙΑΙΟΣ ΨΗΦΙΑΚΟΣ ΘΕΡΜΟΣΤΑΤΗΣ ΧΩΡΟΥ</b> WEEKLY DIGITAL INDOOR THERMOSTAT 56</p>  <p><b>ΕΒΔΟΜΑΔΙΑΙΟΣ ΨΗΦΙΑΚΟΣ ΘΕΡΜΟΣΤΑΤΗΣ ΧΩΡΟΥ</b> WEEKLY DIGITAL INDOOR THERMOSTAT 56</p>  <p><b>ΕΒΔΟΜΑΔΙΑΙΟΣ ΨΗΦΙΑΚΟΣ ΘΕΡΜΟΣΤΑΤΗΣ ΧΩΡΟΥ</b> WEEKLY DIGITAL INDOOR THERMOSTAT 56</p>  <p><b>ΕΒΔΟΜΑΔΙΑΙΟΣ ΨΗΦΙΑΚΟΣ ΘΕΡΜΟΣΤΑΤΗΣ ΧΩΡΟΥ</b> WEEKLY DIGITAL INDOOR THERMOSTAT 57</p>  <p><b>ΕΒΔΟΜΑΔΙΑΙΟΣ ΨΗΦΙΑΚΟΣ ΘΕΡΜΟΣΤΑΤΗΣ ΧΩΡΟΥ</b> WEEKLY DIGITAL INDOOR THERMOSTAT 57</p>  <p><b>ΕΒΔΟΜΑΔΙΑΙΟΣ ΨΗΦΙΑΚΟΣ ΘΕΡΜΟΣΤΑΤΗΣ ΧΩΡΟΥ</b> WEEKLY DIGITAL INDOOR THERMOSTAT 57</p>  <p><b>ΕΒΔΟΜΑΔΙΑΙΟΣ ΨΗΦΙΑΚΟΣ ΘΕΡΜΟΣΤΑΤΗΣ ΧΩΡΟΥ</b> WEEKLY DIGITAL INDOOR THERMOSTAT 57</p>							

<p>ΗΧΕΙΑ ΧΩΝΕΥΤΑ CEILING SPEAKERS</p>	 <p><b>ΗΧΕΙΟ ΟΡΟΦΗΣ</b> AUDIO SPEAKER 58</p>					
<p>ΕΞΑΕΡΙΣΤΗΡΑΣ ΛΟΥΤΡΟΥ BATH VENTILATION</p>	 <p><b>ΕΞΑΕΡΙΣΤΗΡΑΣ ΜΠΑΝΙΟΥ</b> BATH VENTILATION FAN 60</p>		 <p><b>ΕΞΑΕΡΙΣΤΗΡΑΣ ΜΠΑΝΙΟΥ ΜΕ ΧΡΟΝΟΔΙΑΚΟΠΤΗ</b> BATH VENTILATION FAN WITH TIMER 60</p>		 <p><b>ΕΞΑΕΡΙΣΤΗΡΑΣ ΜΠΑΝΙΟΥ ΜΕ ΧΡΟΝΟΔΙΑΚΟΠΤΗ</b> BATH VENTILATION FAN WITH TIMER 60</p>  <p><b>ΕΞΑΕΡΙΣΤΗΡΑΣ ΜΠΑΝΙΟΥ</b> BATH VENTILATION FAN 61</p>  <p><b>ΕΞΑΕΡΙΣΤΗΡΑΣ ΜΠΑΝΙΟΥ</b> BATH VENTILATION FAN 61</p>	
 <p><b>ΕΞΑΕΡΙΣΤΗΡΑΣ ΜΠΑΝΙΟΥ</b> BATH VENTILATION FAN 61</p>	 <p><b>ΕΞΑΕΡΙΣΤΗΡΑΣ ΜΠΑΝΙΟΥ</b> BATH VENTILATION FAN 61</p>					
<p>ΣΕΣΟΥΑΡ ΞΕΝΟΔΟΧΕΙΟΥ HAIR DRYER FOR HOTELS</p>	 <p><b>ΣΕΣΟΥΑΡ ΞΕΝΟΔΟΧΕΙΟΥ</b> HOTEL HAIR DRYER 62</p>		 <p><b>ΣΕΣΟΥΑΡ ΞΕΝΟΔΟΧΕΙΟΥ</b> HOTEL HAIR DRYER 62</p>		<p>ΣΤΕΓΝΩΤΗΡΑΣ ΧΕΡΙΩΝ HAND DRYERS</p>  <p><b>ΣΤΕΓΝΩΤΗΡΑΣ ΧΕΡΙΩΝ ΠΛΑΣΤΙΚΟΣ ΜΕ ΧΡΟΝΟΔΙΑΚΟΠΤΗ</b> PLASTIC HAND DRYER WITH TIMER 62</p>	
<p>ΜΟΝΩΤΙΚΕΣ ΤΑΙΝΙΕΣ PVC ELECTRICAL INSULATING TAPE</p>	 <p><b>ΜΟΝΩΤΙΚΕΣ ΤΑΙΝΙΕΣ</b> PVC ELECTRICAL INSULATING TAPES 64</p>		 <p><b>ΜΟΝΩΤΙΚΕΣ ΤΑΙΝΙΕΣ</b> PVC ELECTRICAL INSULATING TAPES 64</p>		 <p><b>ΜΟΝΩΤΙΚΕΣ ΤΑΙΝΙΕΣ</b> PVC ELECTRICAL INSULATING TAPES 64</p>  <p><b>ΜΟΝΩΤΙΚΕΣ ΤΑΙΝΙΕΣ</b> ΑΥΤΟΒΟΥΚΑΝΙΖΟΜΕΝΕΣ PVC TAPES 64</p>  <p><b>ΤΑΙΝΙΑ ΣΥΣΚΕΥΑΣΙΑΣ "FRAGILE"</b> PACKAGING TAPE "FRAGILE" 64</p>	
<p>ΚΑΤΣΑΒΙΔΙΑ SCREWDRIVERS TESTER</p>	 <p><b>ΚΑΤΣΑΒΙΔΙ ΔΟΚΙΜΑΣΤΙΚΟ</b> SCREWDRIVER TESTER 65</p>		 <p><b>ΣΕΤ ΚΑΤΣΑΒΙΔΙ ΔΟΚΙΜΑΣΤΙΚΟ</b> SET SCREWDRIVER TESTER 65</p>		 <p><b>ΣΕΤ ΠΟΛΥΧΡΟΜΟ ΚΑΤΣΑΒΙΔΙ ΔΟΚΙΜΑΣΤΙΚΟ</b> SET MULTICOLOR SCREWDRIVER TESTER 65</p>	

<p>ΠΟΛΥΜΕΤΡΑ MULTIMETER</p>	 <b>ΨΗΦΙΑΚΟ ΠΟΛΥΜΕΤΡΟ</b> DIGITAL MULTIMETER 66	 <b>ΨΗΦΙΑΚΟ ΠΟΛΥΜΕΤΡΟ ΤΣΕΠΗΣ</b> POCKET DIGITAL MULTIMETER 66	 <b>ΨΗΦΙΑΚΗ ΑΜΠΕΡΟΤΣΙΜΠΙΔΑ</b> DIGITAL CLAMP METER 66			
<p>ΑΝΑΛΩΣΙΜΟ ΗΛΕΚΤΡΟΛΟΓΙΚΟ ΥΛΙΚΟ ELECTRICAL CONSUMABLES</p>	 <b>ΣΤΑΝΤ ΓΙΑ ΚΛΕΜΜΕΣ</b> STAND FOR TERMINAL BLOCKS 68	 <b>ΚΛΕΜΜΑ</b> TERMINAL BLOCKS 68	 <b>ΚΛΕΜΜΑ</b> TERMINAL BLOCKS 68	 <b>ΚΛΕΜΜΑ</b> TERMINAL BLOCKS 68	 <b>ΚΛΕΜΜΑ</b> TERMINAL BLOCKS 69	 <b>ΚΛΕΜΜΑ ΣΥΝΔΕΣΜΟΣ</b> TERMINAL CONNECTOR 69
      						
<p><b>ΚΛΕΜΜΑ ΚΛΕΦΤΗΣ</b> TERMINAL BLOCK 69</p>	<p><b>ΚΛΕΜΜΑ ΑΝΤΑΠΤΟΡΑΣ</b> TERMINAL ADAPTER 69</p>	<p><b>ΜΟΥΦΕΣ ΡΗΤΙΝΗΣ</b> STRAIGHT JOINT PRE-FILLED WITH GEL 70</p>	<p><b>ΚΛΕΜΜΑ ΠΟΛΥΠΡΟΠΥΛΕΝΙΟΥ</b> POLYPROPYLENE CONNECTABLE CONDUCTORS 70</p>	<p><b>ΚΛΕΜΜΑ ΠΟΛΥΠΡΟΠΥΛΕΝΙΟΥ ΤΑΧΕΙΑΣ ΣΥΝΔΕΣΗΣ</b> POLYPROPYLENE QUICK CONNECTION 70</p>	<p><b>ΚΥΠΑΡΙΣΣΑΚΙ</b> CONNECTION TERMINAL T8 SUPLEX 70</p>	<p><b>ΜΠΑΡΑ ΟΥΔΑΤΕΡΟΥ</b> DIN RAIL NEUTRAL CONNECTOR 71</p>
      						
<p><b>ΜΠΛΟΚ ΔΙΑΝΟΜΗΣ ΡΑΓΑΣ</b> DIN RAIL DISTRIBUTION BLOCK 71</p>	<p><b>ΔΙΑΚΛΑΔΩΤΗΣ ΡΑΓΑΣ</b> DIN RAIL DISTRIBUTION BUSBAR 71</p>	<p><b>ΚΑΨΕΣ ΚΑΛΩΔΙΩΝ</b> WIRE NUTS 72</p>	<p><b>ΟΥΠΑ</b> WALL PLUGS 72</p>	<p><b>ΜΕΤΑΛΛΙΚΟ ΤΣΕΡΚΙ</b> PERFORATED STEEL BANDING 72</p>	<p><b>ΣΥΝΔΕΣΜΟΣ ΚΑΛΩΔΙΩΝ</b> WATERPROOF WIRE CONNECTORS 72</p>	<p><b>ΣΤΥΠΙΟΘΛΗΠΤΕΣ</b> NYLON CABLE GLANDS 73</p>
      						
<p><b>ΑΤΣΑΛΙΝΕΣ ΠΛΑΣΤΙΚΕΣ ΓΕΡΜΑΝΙΑΣ</b> PLASTIC PULL WIRE CABLE 73</p>	<p><b>ΓΕΙΩΣΗ ΧΑΛΚΟΥ &amp; ΣΦΙΓΚΤΗΡΑΣ ΓΕΙΩΣΗΣ</b> COPPER GROUND &amp; GROUND CABLE CLAMP 73</p>	<p><b>ΔΕΜΑΤΙΚΑ</b> CABLE TIES 74</p>	<p><b>ΔΕΜΑΤΙΚΑ</b> CABLE TIES 75</p>	<p><b>ΔΕΜΑΤΙΚΑ</b> CABLE TIES 75</p>	<p><b>ΡΟΚΑ</b> CABLE CLIP 76</p>	<p><b>ΑΥΤΟΚΟΛΛΗΤΕΣ ΒΑΣΕΙΣ</b> SELF ADHESIVE TIE MOUNTS 76</p>
<p><b>ΣΕΤ ΘΕΡΜΟΣΥΣΤΕΛΛΟΜΕΝΩΝ ΚΑΛΩΔΙΩΝ</b> HEAT SHRINKABLE TUBINGS SET 77</p>	<p><b>ΑΝΤΑΠΤΟΡΑΣ SOLAR</b> SOLAR CONNECTORS 78</p>	<p><b>ΑΝΤΑΠΤΟΡΑΣ SOLAR</b> SOLAR CONNECTORS 78</p>				

<p>ΝΤΟΥΙ LAMP HOLDERS</p>	 <p>ΝΤΟΥΙ ΒΑΚΕΛΙΤΟΥ BAKLITE LAMP HOLDERS 80</p>	 <p>ΝΤΟΥΙ ΠΟΡΣΕΛΑΝΗΣ PORCELAIN LAMP HOLDERS 80</p>	 <p>ΝΤΟΥΙ ΜΕΤΑΛΛΙΚΑ METAL LAMP HOLDERS 81</p>	 <p>ΝΤΟΥΙ ΟΡΕΙΧΑΛΚΙΝΑ BRASS LAMP HOLDERS 81</p>	 <p>ΝΤΟΥΙ ΑΝΤΑΠΤΟΡΕΣ LAMP HOLDERS ADAPTERS 81</p>	 <p>ΝΤΟΥΙ ΚΡΕΜΑΣΤΑ PENDANT LAMP HOLDERS 82</p>
<p>ΡΟΖΕΤΕΣ ΟΡΟΦΗΣ / ΝΤΟΥΙ CEILING METAL ROZO CUPS/LAMP HOLDERS 82</p>	 <p>ΚΑΛΩΔΙΟ ΚΟΡΔΟΝΙ ΧΡΩΜΑΤΙΣΤΟ COLORED CORD TYPE CABLE 82</p>	 <p>ΝΤΟΥΙ ΚΡΕΜΑΣΤΑ PENDANT LAMP HOLDERS 83</p>	 <p>ΝΤΟΥΙ ΚΡΕΜΑΣΤΑ PENDANT LAMP HOLDERS 83</p>	 <p>ΒΑΣΗ ΓΛΟΜΠΟΥ ΒΑΚΕΛΙΤΟΥ GLOBE BASE BAKELITE WITH LAMP HOLDER 84</p>	 <p>ΓΥΑΛΙ ΓΛΟΜΠΟΥ GLASS GLOBE 84</p>	
<p>ΚΑΝΑΛΙΑ &amp; ΔΟΜΗΜΕΝΗ ΚΑΛΩΔΙΩΣΗ CABLE TRUNKING &amp; STRUCTURED CABLING</p>	 <p>ΚΑΝΑΛΙΑ ΚΛΕΙΣΤΟΥ ΤΥΠΟΥ CLOSED TYPE CABLE TRUNKING 86</p>	 <p>ΚΑΝΑΛΙΑ ΔΑΠΕΔΟΥ ΑΥΤΟΚΟΛΛΗΤΑ &amp; ΑΠΛΑ ADHESIVE AND NON ADHESIVE FLOOR CABLE TRUNKING 86</p>	 <p>ΚΑΝΑΛΙΑ ΑΥΤΟΚΟΛΛΗΤΑ ADHESIVE CABLE TRUNKING 87</p>	 <p>ΚΑΝΑΛΙ ΔΟΜΗΜΕΝΗΣ STRUCTURED CABLE TRUNKING 88</p>	 <p>ΚΑΝΑΛΙ ΔΟΜΗΜΕΝΗΣ STRUCTURED CABLE TRUNKING 89</p>	
<p>ΕΞΑΡΤΗΜΑΤΑ ΔΟΜΗΜΕΝΗΣ ΚΑΛΩΔΙΩΣΗΣ STRUCTURED CABLING ACCESSORIES</p>	 <p>ΓΩΝΙΕΣ ΔΟΜΗΜΕΝΗΣ STRUCTURED ANGLES 88</p>	 <p>ΤΑΦ ΔΟΜΗΜΕΝΗΣ T STRUCTURED 88</p>	 <p>ΓΩΝΙΑ 90° ΔΟΜΗΜΕΝΗΣ ANGLE 90° STRUCTURED 88</p>			
<p>ΓΩΝΙΕΣ ΔΟΜΗΜΕΝΗΣ STRUCTURED ANGLES 89</p>	 <p>ΤΑΦ ΔΟΜΗΜΕΝΗΣ T STRUCTURED 89</p>	 <p>ΓΩΝΙΑ 90° ΔΟΜΗΜΕΝΗΣ ANGLE 90° STRUCTURED 89</p>	 <p>ΤΑΠΑ ΔΟΜΗΜΕΝΗΣ CUP STRUCTURED 89</p>	 <p>ΕΝΩΤΙΚΟ ΓΙΑ ΚΑΠΑΚΙ JUNCTION FOR COVER 89</p>	 <p>ΠΛΑΙΣΙΑ ΔΟΜΗΜΕΝΗΣ ASSEMBLY SET FOR STRUCTURED 90</p>	
<p>ΚΥΤΙΑ, ΜΠΟΥΑΤ, ΚΟΥΤ. ΕΞΩΤΕΡΙΚΑ &amp; ΓΥΦΟΣΑΝΙΔΑΣ HATCH, ΒΟΑΤ, EXTERIOR &amp; DRYWALL BOX</p>	 <p>ΠΛΗΚΤΡΑ ΤΗΛΕΦΩΝΟΥ DATA TELEPHONE KEYS DATA 90</p>	 <p>ΦΙΣ ΕΝΩΤΙΚΟ PLUG CONNECTOR 90</p>	 <p>ΠΡΙΖΕΣ ΣΟΥΚΟ SCHUKO SOCKETS 91</p>	 <p>UK ΠΡΙΖΕΣ UK SOCKETS 91</p>	 <p>ΠΡΙΖΕΣ ΤΗΛΕΟΡΑΣΗΣ TELEVISION SOCKETS 91</p>	

ΣΩΛΗΝΕΣ  
ΕΥΘΕΙΑΣ &  
ΣΠΙΡΑΛ  
STRAIGHT &  
SPIRAL TUBES



ΣΩΛΗΝΕΣ ΕΥΘΕΙΑΣ  
ΜΕΣΑΙΟΥ ΤΥΠΟΥ  
STRAIGHT TUBES  
MEDIUM TYPE  
92



ΣΤΗΡΙΓΜΑΤΑ ΓΙΑ  
ΣΩΛΗΝΕΣ ΜΕΣΑΙΟΥ  
ΤΥΠΟΥ  
SUPPORT FOR TUBES  
MEDIUM TYPE  
92



ΓΩΝΙΕΣ ΓΙΑ ΣΩΛΗΝΕΣ  
ΜΕΣΑΙΟΥ ΤΥΠΟΥ  
BEND CURVES  
FOR CONDUITS  
92



ΜΟΥΦΕΣ ΓΙΑ ΣΩΛΗΝΕΣ  
ΜΕΣΑΙΟΥ ΤΥΠΟΥ  
COUPLERS FOR TUBES  
MEDIUM TYPE  
92



ΑΝΤΑΠΤΟΡ ΣΩΛΗΝΑΣ  
ΣΕ ΜΠΟΥΑΤ  
ADAPTER FOR TUBES  
93



ΑΝΤΑΠΤΟΡ ΣΩΛΗΝΑΣ  
ΣΕ ΤΑΦ  
ADAPTER FOR T TUBES  
93



ΕΥΚΑΜΠΤΗ ΓΩΝΙΑ  
ΣΠΙΡΑΛ  
FLEXIBLE SPIRAL BEND  
CURVE CONNECTOR  
93



ΣΩΛΗΝΕΣ ΣΠΙΡΑΛ  
ΜΕΣΑΙΟΥ ΤΥΠΟΥ  
SPIRAL TUBES  
MEDIUM TYPE  
94



ΣΩΛΗΝΕΣ ΣΠΙΡΑΛ  
ΒΑΡΕΩΣ ΤΥΠΟΥ  
SPIRAL TUBES  
HEAVY TYPE  
94



ΣΩΛΗΝΕΣ ΣΠΙΡΑΛ  
ΕΛΑΦΡΟΥ ΤΥΠΟΥ ΜΕ  
ΟΔΗΓΟ  
SPIRAL TUBES LIGHT  
TYPE WITH WIRE  
94



ΑΝΤΑΠΤΟΡ ΣΩΛΗΝΑΣ  
ΣΠΙΡΑΛ ΣΕ ΜΠΟΥΑΤ  
ADAPTER SPIRAL  
FOR FUSE BOX  
94



ΣΠΙΡΑΛ ΣΩΛΗΝΕΣ ΜΕΣΑΙΟΥ  
ΤΥΠΟΥ ΧΩΡΙΣ ΑΛΟΓΟΝΑ  
ΜΕ ΠΥΡΑΝΤΙΣΤΑΣΗ  
SPIRAL TUBES MEDIUM  
TYPE, HALOGEN FREE & FIRE  
RESISTANCE  
95



ΣΠΙΡΑΛ ΣΩΛΗΝΕΣ ΒΑΡΕΩΣ  
ΤΥΠΟΥ ΧΩΡΙΣ ΑΛΟΓΟΝΑ  
ΜΕ ΠΥΡΑΝΤΙΣΤΑΣΗ  
SPIRAL TUBES HEAVY TYPE,  
HALOGEN FREE & FIRE  
RESISTANCE  
95



ΣΩΛΗΝΕΣ ΣΠΙΡΑΛ  
ΕΛΑΦΡΟΥ ΤΥΠΟΥ ΧΩΡΙΣ  
ΑΛΟΓΟΝΑ  
SPIRAL TUBES LIGHT  
TYPE HALOGEN FREE  
95



ΣΩΛΗΝΕΣ ΣΠΙΡΑΛ  
ΕΛΑΦΡΟΥ ΤΥΠΟΥ  
SPIRAL TUBES  
LIGHT TYPE  
96



ΣΩΛΗΝΕΣ ΜΠΕΤΟΥ  
CONCRETE TUBES  
96



ΣΩΛΗΝΕΣ ΧΕΛΙΦΑΕΣ  
SPIRAL CONDUITS  
96

ΚΑΛΩΔΙΑ  
ΤΗΛΕΦΩΝΟΥ,  
ΔΙΚΤΥΟΥ & TV,  
ΕΞΑΡΤΗΜΑΤΑ  
TELEPHONE, TV  
& NETWORK  
CABLES,  
ACCESSORIES



ΦΙΣ ΤΗΛΕΦΩΝΟΥ Α.Τ.  
UTP CONNECTORS  
98



ΑΝΤΑΠΤΟΡΕΣ  
ΤΗΛΕΦΩΝΟΥ &  
ΣΥΝΔΕΣΜΟΙ  
TELEPHONE ADAPTERS &  
CONNECTORS  
98



ΠΡΙΖΕΣ ΤΗΛΕΦΩΝΟΥ  
TELEPHONE  
SOCKETS DATA  
98



ΦΙΛΤΡΟ ΓΡΑΜΜΗΣ ADSL  
& SPLITTER  
TELEPHONE  
FILTER ADSL & SPLITTER  
99



ΠΡΟΕΚΤΑΣΕΙΣ  
ΤΗΛΕΦΩΝΟΥ  
EXTENSION  
TELEPHONE CORDS  
99



ΣΠΙΡΑΛ ΤΗΛΕΦΩΝΟΥ  
TELEPHONE SPIRAL  
99



ΚΑΛΩΔΙΑ ΤΗΛΕΦΩΝΟΥ  
ΠΛΑΚΕ 2 ΖΕΥΓΩΝ  
TELEPHONE CABLES  
FLAT 2 PAIR  
99



ΠΡΟΕΚΤΑΣΕΙΣ ΔΙΚΤΥΟΥ  
UTP CAT.5E  
EXTENSION CORDS UTP  
CAT.5E  
100



ΠΡΟΕΚΤΑΣΕΙΣ ΔΙΚΤΥΟΥ  
UTP CAT.6E  
EXTENSION CORDS UTP  
CAT.6E  
100



ΟΡΙΟΛΟΡΙΔΕΣ  
DISCONNECTION  
MODULES  
100



ΠΡΕΣΣΕΣ ΤΗΛΕΦΩΝΟΥ  
CRIMPING TELEPHONE  
TOOLS  
100



ΦΙΣ TV ΠΛΑΓΙΑΣ  
TV PLUG ANGLE  
101



ΤΑΦ TV  
TV ADAPTER  
101



ΦΙΣ TV  
PLUG  
101



ΦΙΣ F  
PLUG F  
101



ΠΡΟΕΚΤΑΣΗ TV  
TV EXTENSION CABLE  
101



ΔΙΑΚΛΑΔΩΤΗΣ TV  
2 WAY TV SPLITTER  
102



ΜΙΚΤΗΣ TV - SAT  
SATELLITE SPLITTER  
TV - SAT  
103



ΚΑΛΩΔΙΑ ΣΥΝΔΕΣΗΣ  
HDMI  
HDMI CABLES  
103



SCART ΣΕ SCART  
SCART TO SCART  
103

ΠΙΝΑΚΕΣ  
DIN RAIL  
ENCLOSURE



ΠΙΝΑΚΕΣ ΧΩΝΕΥΤΟΙ  
ΜΕ ΠΟΡΤΑ  
RECESSED FUSE DIN RAIL  
ENCLOSURE  
WITH DOOR  
104



ΠΙΝΑΚΕΣ ΧΩΝΕΥΤΟΙ  
ΜΕ ΠΟΡΤΑ  
RECESSED FUSE DIN RAIL  
ENCLOSURE  
WITH DOOR  
105



ΠΙΝΑΚΑΣ ΕΞΩΤΕΡΙΚΟΣ  
2 ΘΕΣΕΩΝ  
2-MODULE SURFACED  
DIN RAIL ENCLOSURE  
106



ΠΙΝΑΚΑΣ ΕΞΩΤΕΡΙΚΟΣ  
4 ΘΕΣΕΩΝ  
4-MODULE SURFACED  
DIN RAIL ENCLOSURE  
106



ΠΙΝΑΚΑΣ ΕΞΩΤΕΡΙΚΟΣ  
2 ΘΕΣΕΩΝ ΜΕ ΠΟΡΤΑ  
2-MODULE SURFACED  
DIN RAIL ENCLOSURE  
WITH DOOR  
106



ΠΙΝΑΚΑΣ ΕΞΩΤΕΡΙΚΟΣ  
4 ΘΕΣΕΩΝ ΜΕ ΠΟΡΤΑ  
4-MODULE SURFACED  
DIN RAIL ENCLOSURE  
WITH DOOR  
106



ΠΙΝΑΚΑΣ ΕΞΩΤΕΡΙΚΟΣ  
6 ΘΕΣΕΩΝ ΜΕ ΠΟΡΤΑ  
6-MODULE SURFACED  
DIN RAIL ENCLOSURE  
WITH DOOR  
107



ΠΙΝΑΚΑΣ ΕΞΩΤΕΡΙΚΟΣ  
8 ΘΕΣΕΩΝ ΜΕ ΠΟΡΤΑ  
8-MODULE SURFACED  
DIN RAIL ENCLOSURE  
WITH DOOR  
107



ΠΙΝΑΚΑΣ ΕΞΩΤΕΡΙΚΟΣ  
12 ΘΕΣΕΩΝ ΜΕ ΠΟΡΤΑ  
12-MODULE SURFACED  
DIN RAIL ENCLOSURE  
WITH DOOR  
107



ΠΙΝΑΚΑΣ ΕΞΩΤΕΡΙΚΟΣ  
18 ΘΕΣΕΩΝ ΜΕ ΠΟΡΤΑ  
18-MODULE SURFACED  
DIN RAIL ENCLOSURE  
WITH DOOR  
107



ΠΙΝΑΚΑΣ ΕΞΩΤΕΡΙΚΟΣ  
24 ΘΕΣΕΩΝ ΜΕ ΠΟΡΤΑ  
24-MODULE SURFACED  
DIN RAIL ENCLOSURE  
WITH DOOR  
107



ΠΙΝΑΚΑΣ ΕΞΩΤΕΡΙΚΟΣ  
36 ΘΕΣΕΩΝ ΜΕ ΠΟΡΤΑ  
36-MODULE SURFACED  
DIN RAIL ENCLOSURE  
WITH DOOR  
107



ΠΙΝΑΚΑΣ ΧΩΝΕΥΤΟΣ  
12 ΘΕΣΕΩΝ ΜΕ ΠΟΡΤΑ  
12-MODULE RECESSED  
DIN RAIL ENCLOSURE  
WITH DOOR  
108



ΠΙΝΑΚΑΣ ΧΩΝΕΥΤΟΣ  
18 ΘΕΣΕΩΝ ΜΕ ΠΟΡΤΑ  
18-MODULE RECESSED  
DIN RAIL ENCLOSURE  
WITH DOOR  
108



ΠΙΝΑΚΑΣ ΧΩΝΕΥΤΟΣ  
24 ΘΕΣΕΩΝ ΜΕ ΠΟΡΤΑ  
24-MODULE RECESSED  
DIN RAIL ENCLOSURE  
WITH DOOR  
108



ΠΙΝΑΚΑΣ ΧΩΝΕΥΤΟΣ  
36 ΘΕΣΕΩΝ ΜΕ ΠΟΡΤΑ  
36-MODULE RECESSED  
DIN RAIL ENCLOSURE  
WITH DOOR  
108



ΡΑΓΑ ΑΣΦΑΛΕΙΩΝ  
DIN RAIL BAR  
109



ΠΙΝΑΚΑΣ ΧΩΝΕΥΤΟΣ  
ΜΕΤΑΛΛΙΚΟΣ  
RECESSED  
DIN RAIL ENCLOSURE  
110



ΠΙΝΑΚΑΣ ΧΩΝΕΥΤΟΣ  
ΜΕΤΑΛΛΙΚΟΣ  
RECESSED  
DIN RAIL ENCLOSURE  
110



ΠΙΝΑΚΑΣ ΕΞΩΤΕΡΙΚΟΣ  
ΜΕΤΑΛΛΙΚΟΣ  
SURFACED  
DIN RAIL ENCLOSURE  
111



ΒΙΟΜΗΧΑΝΙΚΟ  
ΚΙΒΩΤΙΟ ABS  
ABS PANEL BOX  
112



ΒΙΟΜΗΧΑΝΙΚΟ  
ΚΙΒΩΤΙΟ ABS ΚΕΝΟ ΜΕ  
ΔΙΑΦΑΝΗ ΠΟΡΤΑ  
ABS EMPTY PANEL BOX  
TRANSPARENT DOOR  
112



ΜΕΤΩΠΗ ΗΛΕΚΤΡΟΛ.  
ΠΙΝΑΚΑ ΠΟΛΥΚΑΡΒ.  
ΚΙΒΩΤΙΟΥ  
PC ELECTRICAL  
ENCLOSURE FRONT  
PANEL  
113



ΜΕΤΑΛΛΙΚΗ ΠΛΑΤΗ  
ΠΟΛΥΚΑΡΒ. ΚΙΒΩΤΙΟΥ  
GALVANIZED SHEET FOR  
ABS PANEL BOX  
114



ΦΙΛΤΡΟ ΕΞΑΕΡΙΣΜΟΥ  
ΠΟΛΥΚΑΡΒ. ΚΙΒΩΤΙΟΥ  
VENTILATION FILTER FOR  
ABS PANEL BOX  
114



ΜΟΝΟ ΠΛΑΣΤΙΚΟ ΚΛΕΙΔΙ  
ΠΟΛΥΚΑΡΒ. ΚΙΒΩΤΙΟΥ  
SINGLE PLASTIC KEY  
ABS PANEL BOX  
114



ΚΙΤ ΣΤΗΡΙΞΗΣ  
ΠΟΛΥΚΑΡΒ. ΚΙΒΩΤΙΟΥ  
MOUNTING KEYS FOR  
ABS PANEL BOX  
114

ΚΥΤΙΑ,  
ΜΠΟΥΑΤ, ΚΟΥΤ.  
ΕΞΩΤΕΡΙΚΑ  
HATCH, BOAT,  
EXTERIOR BOX



ΒΙΟΜΗΧΑΝΙΚΟ ΦΡΕΑΤΙΟ  
INDUSTRIAL PLASTIC  
MANHOLE  
115

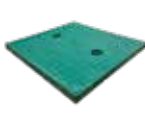

ΠΡΑΣΙΝΟ ΚΑΠΑΚΙ ΓΙΑ  
ΠΛΑΣΤΙΚΟ ΦΡΕΑΤΙΟ  
GREEN INDUSTRIAL  
PLASTIC MANHOLE  
115



ΜΠΟΥΑΤ ΕΞΩΤΕΡΙΚΟ  
ΣΤΡΟΓΓΥΛΟ  
JUNCTION BOXES  
CIRCULAR  
116



ΜΠΟΥΑΤ ΕΞΩΤΕΡΙΚΟ  
ΣΤΡΟΓΓΥΛΟ  
SQUARE JUNCTION BOX  
117



ΜΠΟΥΑΤ ΕΞΩΤΕΡΙΚΟ  
ΜΕ ΒΙΔΕΣ  
SQUARE JUNCTION BOX  
WITH SCREWS  
118



ΜΠΟΥΑΤ ΕΞΩΤΕΡΙΚΟ  
ΦΙΜΕ ΜΕ ΒΙΔΕΣ  
SQUARE JUNCTION  
TINTED BOX WITH  
SCREWS  
119



ΒΙΟΜΗΧΑΝΙΚΟ  
ΕΞΩΤΕΡΙΚΟ ΜΠΟΥΑΤ  
ΜΕ ΒΙΔΕΣ  
INDUSTRIAL JUNCTION  
BOX WITH SCREWS  
119



ΚΟΥΤΙ ΜΕ  
ΣΤΥΠΙΟΦΘΗΛΙΤΕΣ P68  
WATERPROOF BOX WITH  
CABLE GLANDS  
120



ΚΥΤΙΑ ΓΥΦΟΣΑΝΙΔΑΣ  
PLASTERBOARD BOXES  
120





























ΚΥΤΙΑ ΔΙΑΚΛΑΔΩΣΗΣ  
ΓΥΦΟΣΑΝΙΔΑΣ  
PLASTERBOARD  
JUNCTION BOXES  
120



ΚΥΤΙΑ ΔΙΑΚΛΑΔΩΣΗΣ  
ΣΤΡΟΓΓΥΛΑ  
ROUND  
JUNCTION BOXES  
121



ΚΥΤΙΑ ΔΙΑΚΛΑΔΩΣΗΣ  
ΤΕΤΡΑΓΩΝΑ  
SQUARE  
JUNCTION BOXES  
121

<p>ΚΥΤΙΑ, ΜΠΟΥΑΤ, ΚΟΥΤ. ΕΞΩΤΕΡΙΚΑ HATCH, BOAT, EXTERIOR BOX</p>	 <b>ΚΑΠΑΚΙ ΓΙΑ ΚΟΥΤΙ ΔΙΑΚΛΑΔΩΣΗΣ</b> COVER FOR JUNCTION BOX 121	 <b>ΚΥΤΙΑ ΔΙΑΚΟΠΤΟΥ &amp; ΣΥΝΔΕΣΜΟΙ</b> SWITCH BOXES & CONNECTORS 121	 <b>ΚΑΠΑΚΙ ΜΕ ΑΥΤΙΑ</b> COVER WITH EARS 122	 <b>ΚΑΠΑΚΙ ΠΡΟΣΤΑΣΙΑ ΠΡΙΖΑΣ</b> SOCKET COVER 122	 <b>ΓΕΜΙΣΜΑΤΑ ΠΙΝΑΚΩΣ</b> DIN ENCLOSURE FILLINGS 122	
<p>ΔΙΑΚΟΠΤΕΣ SWITCHES</p>	 <b>ΕΞΩΤΕΡΙΚΟΙ ΔΙΑΚΟΠΤΕΣ</b> SURFACE SWITCHES 124	 <b>ΕΞΩΤΕΡΙΚΟΙ ΔΙΑΚΟΠΤΕΣ</b> SURFACE SWITCHES 124	 <b>ΕΞΩΤΕΡΙΚΟΙ ΔΙΑΚΟΠΤΕΣ</b> SURFACE SWITCHES 125			
<p>ΠΡΙΖΕΣ WALL SWITCHES</p>	 <b>ΕΞΩΤΕΡΙΚΕΣ ΠΡΙΖΕΣ ΜΕ ΚΑΠΑΚΙ</b> OUTDOOR SOCKETS WITH COVER 124	 <b>ΕΞΩΤΕΡΙΚΕΣ ΠΡΙΖΕΣ ΜΕ ΚΑΠΑΚΙ</b> OUTDOOR SOCKETS WITH COVER 124	 <b>ΕΞΩΤΕΡΙΚΕΣ ΠΡΙΖΕΣ ΣΟΥΚΟ</b> OUTDOOR SCHUKO SOCKETS 125	 <b>ΠΡΙΖΕΣ TV, ΤΗΛΕΦΩΝΟΥ &amp; DATA</b> TV SOCKETS, PHONE & DATA 125		
<p>ΗΛΕΚΤΡΟΝΙΚΟΙ ΡΟΣΤΑΤΕΣ ΓΙΑ LED ΛΑΜΠΕΣ ELECTRONIC DIMMERS FOR LED LAMPS 126</p>	 <b>ΗΛΕΚΤΡΟΝΙΚΟΙ ΡΟΣΤΑΤΕΣ ΓΙΑ LED ΛΑΜΠΕΣ</b> ELECTRONIC DIMMERS FOR LED LAMPS 126	 <b>ΔΙΑΚΟΠΤΑΚΙΑ ΕΝΔΙΑΜΕΣΑ</b> MIDDLE SWITCHES 104	 <b>ΠΡΟΕΚΤΑΣΗ ΚΑΛΩΔ. ΦΙΣ &amp; ΕΝΔΙΑΜΕΣΟ ΔΙΑΚΟΠΤΗ</b> CABLE EXTENSION WITH PLUG & INTERMEDIATE SWITCH CORD 104			
<p>ΑΣΦΑΛΕΙΕΣ ΓΙΑ ΒΙΟΜΗΧΑΝΙΚΗ &amp; ΟΙΚΙΑΚΗ ΧΡΗΣΗ PORCELAINE FUSES FOR INDUSTRIAL &amp; DOMESTIC USE</p>	 <b>ΑΣΦΑΛΕΙΕΣ ΝΕΟΖΕΔ</b> FUSES NEOZED 128	 <b>ΑΣΦΑΛΕΙΕΣ ΔΕΗ</b> FUSES DEI 128	 <b>ΑΣΦΑΛΕΙΕΣ ΝΟΡΜΑΛ</b> FUSES NORMAL 128	 <b>ΑΣΦΑΛΕΙΕΣ ΜΑΧΑΙΡΩΤΕΣ No. 00</b> BLADE TYPE FUSES No. 00 128	 <b>ΚΥΛΙΝΔΡΙΚΑ ΦΥΣΙΓΓΙΑ</b> CYLINDRICAL FUSES 129	 <b>ΚΥΛΙΝΔΡΙΚΑ ΦΥΣΙΓΓΙΑ DC</b> CYLINDRICAL FUSES DC 129
<p>ΝΕΟΖΕΔ ΒΑΣΕΙΣ NEOZED BASES 129</p>	 <b>ΝΕΟΖΕΔ ΠΩΜΑΤΑ</b> NEOZED CAPS 129	 <b>ΝΕΟΖΕΔ ΚΑΛΥΜΜΑΤΑ</b> NEOZED COVERS 129	 <b>ΝΕΟΖΕΔ ΠΛΗΡΗΣ</b> NEOZED SET 129	 <b>ΝΟΡΜΑΛ ΒΑΣΕΙΣ</b> NORMAL BASES 130	 <b>ΝΟΡΜΑΛ ΠΩΜΑΤΑ</b> NORMAL CAPS 130	 <b>ΝΟΡΜΑΛ ΚΑΛΥΜΜΑΤΑ</b> NORMAL COVERS 130

ΑΣΦΑΛΕΙΕΣ ΠΑ  
ΒΙΟΜΗΧΑΝΙΚΗ  
& ΟΙΚΙΑΚΗ ΧΡΗΣΗ  
PORSELAINE  
FUSES FOR  
INDUSTRIAL &  
DOMESTIC USE



**ΔΕΗ ΠΟΛΜΑ**  
DEI CAP  
130



**ΜΗΤΡΕΣ**  
ADAPTERS  
130

GACIA  
ELECTRICAL



**ΜΙΚΡΟΥΤΟΜΑΤΟΣ**  
**ΡΑΓΑΣ ΜΟΝΟΠΟΛΙΚΟΣ**  
**ΚΑΜΠΥΛΗ Β**  
MINIATURE CIRCUIT  
BREAKER 1P 6kA CURVE B  
133



**ΜΙΚΡΟΥΤΟΜΑΤΟΣ**  
**ΡΑΓΑΣ ΔΙΠΟΛΙΚΟΣ**  
**ΚΑΜΠΥΛΗ Β**  
MINIATURE CIRCUIT  
BREAK. MODULE 1P+N  
3kA CURVE B  
133



**ΜΙΚΡΟΥΤΟΜΑΤΟΣ**  
**ΡΑΓΑΣ ΔΙΠΟΛΙΚΟΣ**  
**ΚΑΜΠΥΛΗ Β**  
MINIATURE CIRCUIT  
BREAK. MODULE 1P+N  
3kA CURVE B  
133



**ΜΙΚΡΟΥΤΟΜΑΤΟΣ**  
**ΡΑΓΑΣ ΜΟΝΟΠΟΛΙΚΟΣ**  
**ΚΑΜΠΥΛΗ Β**  
MINIATURE CIRCUIT  
BREAKER 1P 6kA CURVE B  
135



**ΜΙΚΡΟΥΤΟΜΑΤΟΣ**  
**ΡΑΓΑΣ ΤΡΙΠΟΛΙΚΟΣ**  
**ΚΑΜΠΥΛΗ Β**  
MINIATURE CIRCUIT  
BREAKER 3P 6kA  
CURVE B  
135



**ΜΙΚΡΟΥΤΟΜΑΤΟΣ**  
**ΡΑΓΑΣ ΤΕΤΡΑΠΟΛΙΚΟΣ**  
**ΚΑΜΠΥΛΗ Β**  
MINIATURE CIRCUIT  
BREAKER 4P 6kA  
CURVE B  
135



**ΜΙΚΡΟΥΤΟΜΑΤΟΣ**  
**ΡΑΓΑΣ ΜΟΝΟΠΟΛΙΚΟΣ**  
**ΚΑΜΠΥΛΗ C**  
MINIATURE CIRCUIT  
BREAKER 1P 6kA CURVE C  
137



**ΜΙΚΡΟΥΤΟΜΑΤΟΣ**  
**ΡΑΓΑΣ ΔΙΠΟΛΙΚΟΣ**  
**ΚΑΜΠΥΛΗ C**  
MINIATURE CIRCUIT  
BREAKER 2P 6kA  
CURVE C  
137



**ΜΙΚΡΟΥΤΟΜΑΤΟΣ**  
**ΡΑΓΑΣ ΔΙΠΟΛΙΚΟΣ**  
**ΚΑΜΠΥΛΗ C**  
MINIATURE CIRCUIT  
BREAKER 1P+N 6kA  
CURVE C  
137



**ΜΙΚΡΟΥΤΟΜΑΤΟΣ**  
**ΡΑΓΑΣ ΤΕΤΡΑΠΟΛΙΚΟΣ**  
**ΚΑΜΠΥΛΗ C**  
MINIATURE CIRCUIT  
BREAKER 4P 6kA  
CURVE C  
137



**ΜΙΚΡΟΥΤΟΜΑΤΟΣ**  
**ΡΑΓΑΣ ΤΡΙΠΟΛΙΚΟΣ**  
**ΚΑΜΠΥΛΗ C**  
MINIATURE CIRCUIT  
BREAKER 3P 6kA  
CURVE C  
137



**ΜΙΚΡΟΥΤΟΜΑΤΟΣ**  
**ΡΑΓΑΣ ΜΟΝΟΠΟΛΙΚΟΣ**  
**ΚΑΜΠΥΛΗ D**  
MINIATURE CIRCUIT  
BREAKER 1P 6kA CURVE D  
139



**ΜΙΚΡΟΥΤΟΜΑΤΟΣ**  
**ΡΑΓΑΣ ΔΙΠΟΛΙΚΟΣ**  
**ΚΑΜΠΥΛΗ D**  
MINIATURE CIRCUIT  
BREAKER 1P+N 6kA  
CURVE D  
139



**ΜΙΚΡΟΥΤΟΜΑΤΟΣ**  
**ΡΑΓΑΣ ΤΡΙΠΟΛΙΚΟΣ**  
**ΚΑΜΠΥΛΗ D**  
MINIATURE CIRCUIT  
BREAKER 3P 6kA  
CURVE D  
139



**ΜΙΚΡΟΥΤΟΜΑΤΟΣ**  
**ΡΑΓΑΣ ΤΕΤΡΑΠΟΛΙΚΟΣ**  
**ΚΑΜΠΥΛΗ D**  
MINIATURE CIRCUIT  
BREAKER 4P 6kA  
CURVE D  
139



**ΜΙΚΡΟΥΤΟΜΑΤΟΣ**  
**ΡΑΓΑΣ ΔΙΠΟΛΙΚΟΣ**  
**ΚΑΜΠΥΛΗ C**  
MINIATURE CIRCUIT  
BREAKER 1P+N 10kA  
CURVE C  
141



**ΜΙΚΡΟΥΤΟΜΑΤΟΣ**  
**ΡΑΓΑΣ ΤΕΤΡΑΠΟΛΙΚΟΣ**  
**ΚΑΜΠΥΛΗ C**  
MINIATURE CIRCUIT  
BREAKER 3P+N 10kA  
CURVE C  
141



**ΡΑΓΟΔΙΑΚΟΠΤΕΣ**  
DIN RAIL ISOLATORS  
143



**ΔΙΑΚΟΠΤΗΣ ΔΙΑΡΡΟΗΣ**  
**ΤΥΠΟΥ Α**  
RESIDUAL CURRENT  
CIRCUIT BREAKER 30mA  
6kA TYPE A  
145



**ΔΙΑΚΟΠΤΗΣ ΔΙΑΡΡΟΗΣ**  
**ΤΥΠΟΥ Α**  
RESIDUAL CURRENT  
CIRCUIT BREAKER 300mA  
6kA TYPE A  
145



**ΔΙΑΚΟΠΤΗΣ ΔΙΑΡΡΟΗΣ**  
**ΤΥΠΟΥ AC-S**  
RESIDUAL CURRENT  
CIRCUIT BREAKER 30mA  
6kA TYPE AC  
145



**ΔΙΑΚΟΠΤΗΣ ΔΙΑΡΡΟΗΣ**  
**ΤΥΠΟΥ AC**  
RESIDUAL CURRENT  
CIRCUIT BREAKER 300mA  
6kA TYPE AC  
147



**ΔΙΑΚΟΠΤΗΣ ΔΙΑΡΡΟΗΣ**  
**ΤΥΠΟΥ Α**  
RESIDUAL CURRENT  
CIRCUIT BREAKER 30mA  
6kA TYPE A  
147



**ΔΙΑΚΟΠΤΗΣ ΔΙΑΡ. ΜΕ ΣΤΟΙΧΕΙΑ**  
**ΜΙΚΡΟΥΤΟΜ. ΔΙΠΟΛΙΚΟΣ**  
**ΤΥΠΟΥ ΑΚΑΜΠΥΛΗΣ**  
RESIDUAL CURRENT CIRC. BREAK.  
OVERLOAD PROTEC. 1MOD. 30mA  
4.5k IP+N TYPE AC CURVE C  
147



**ΔΙΑΚΟΠΤΗΣ ΔΙΑΡ. ΜΕ ΣΤΟΙΧΕΙΑ**  
**ΜΙΚΡΟΥΤΟΜ. ΔΙΠΟΛΙΚΟΣ**  
**ΤΥΠΟΥ ΑΚΑΜΠΥΛΗΣ**  
RESIDUAL CURRENT CIRC. BREAK.  
OVERLOAD PROTEC. 10mA 6kA  
4.5k IP+N TYPE AC CURVE C  
149



**ΔΙΑΚΟΠΤΗΣ ΔΙΑΡ. ΜΕ ΣΤΟΙΧΕΙΑ**  
**ΜΙΚΡΟΥΤΟΜ. ΜΟΝΟΠΟΛΙΚΟΣ**  
**ΤΥΠΟΥ ΑΚΑΜΠΥΛΗΣ**  
RESIDUAL CURRENT CIRC. BREAK.  
OVERLOAD PROTEC. 1MOD. 30mA  
6k IP+N TYPE AC CURVE C  
149



**ΔΙΑΚΟΠΤΗΣ ΔΙΑΡ. ΜΕ ΣΤΟΙΧΕΙΑ**  
**ΜΙΚΡΟΥΤΟΜ. ΔΙΠΟΛΙΚΟΣ**  
**ΤΥΠΟΥ ΑΚΑΜΠΥΛΗΣ**  
RESIDUAL CURRENT CIRC. BREAK.  
OVERLOAD PROTEC. 30mA 6kA  
IP+N TYPE AC CURVE C  
151



**ΔΙΑΚΟΠΤΗΣ ΔΙΑΡ. ΜΕ ΣΤΟΙΧΕΙΑ**  
**ΜΙΚΡΟΥΤΟΜ. ΜΟΝΟΠΟΛΙΚΟΣ**  
**ΤΥΠΟΥ ΒΚΑΜΠΥΛΗΣ**  
RESIDUAL CURRENT CIRC. BREAK.  
OVERLOAD PROTEC. 30mA 6kA  
IP+N TYPE B CURVE AC  
151



**ΔΙΑΚΟΠΤΗΣ ΔΙΑΡ. ΜΕ ΣΤΟΙΧΕΙΑ**  
**ΜΙΚΡΟΥΤΟΜ. ΔΙΠΟΛΙΚΟΣ**  
**ΤΥΠΟΥ ΒΚΑΜΠΥΛΗΣ**  
RESIDUAL CURRENT CIRC. BREAK.  
OVERLOAD PROTEC. 30mA 6kA  
IP+N TYPE B CURVE AC  
151



**ΔΙΑΚΟΠΤΗΣ ΔΙΑΡ. ΜΕ ΣΤΟΙΧΕΙΑ**  
**ΜΙΚΡΟΥΤΟΜ. ΤΕΤΡΑΠΟΛΙΚΟΣ**  
**ΤΥΠΟΥ ΑΚΑΜΠΥΛΗΣ**  
RESIDUAL CURRENT CIRC. BREAK.  
OVERLOAD PROTEC. 30mA 6kA  
IP+N TYPE A CURVE C  
153



**ΔΙΑΚΟΠΤΗΣ ΔΙΑΡ. ΜΕ ΣΤΟΙΧΕΙΑ**  
**ΜΙΚΡΟΥΤΟΜ. ΤΕΤΡΑΠΟΛΙΚΟΣ**  
**ΤΥΠΟΥ ΑΚΑΜΠΥΛΗΣ**  
RESIDUAL CURRENT CIRC. BREAK.  
OVERLOAD PROTEC. 30mA 6kA  
IP+N TYPE A CURVE C  
153



**ΔΙΑΚΟΠΤΗΣ ΔΙΑΡ. ΜΕ ΣΤΟΙΧΕΙΑ**  
**ΜΙΚΡΟΥΤΟΜ. ΔΙΠΟΛΙΚΟΣ**  
**ΤΥΠΟΥ ΑΚΑΜΠΥΛΗΣ**  
RESIDUAL CURRENT CIRC. BREAK.  
OVERLOAD PROTEC. 10mA 6kA  
IP+N TYPE A CURVE C  
153



**ΔΙΑΚΟΠΤΗΣ ΔΙΑΡ. ΜΕ ΣΤΟΙΧΕΙΑ**  
**ΜΙΚΡΟΥΤΟΜ. ΤΕΤΡΑΠΟΛΙΚΟΣ**  
**ΤΥΠΟΥ Α**  
RESIDUAL CURRENT CIRC. BREAK.  
OVERLOAD PROTEC. 30mA 6kA  
3P+N TYPE A  
155



**ΧΡΟΝΟΔΙΑΚΟΠΤΗΣ**  
**ΡΑΓΑΣ ΦΑΡΔΥΣ**  
**ΨΗΦΙΑΚΟΣ**  
TIMER SWITCH 2  
MODULE. DIGITAL  
157



**ΕΝΔΕΙΚΤΙΚΕΣ ΛΥΧΝΙΕΣ ΡΑΓΑΣ**  
DIN RAIL INDICATOR LIGHT  
156



**ΑΣΦΑΛΕΙΟΘΗΚΕΣ FUSE BASE**  
156



**ΑΣΦΑΛΕΙΟΘΗΚΕΣ DC FUSE BASE DC**  
156



**ΧΡΟΝΟΔΙΑΚΟΠΤΕΣ ΜΕ ΕΦΕΔΕΡΙΑ**  
TIMER SWITCH  
157



**ΑΥΤΟΜΑΤΟΣ ΚΑΙΜΑΚΟΣΤΑΣΙΟΥ**  
AUTOMATIC TIMER STAIRWELL  
157



**ΠΡΙΖΑ ΣΟΥΚΟ ΡΑΓΑΣ**  
DIN RAIL SOCKET  
157



**ΡΕΛΕ ΙΣΧΥΟΣ ΡΑΓΑΣ 220V**  
DIN RAIL MODULAR CONTACTOR 220V  
158



**ΡΕΛΕ ΙΣΧΥΟΣ ΡΑΓΑΣ 24V**  
DIN RAIL MODULAR CONTACTOR 24V  
158



**ΡΕΛΕ ΙΣΧΥΟΣ ΡΑΓΑΣ WIFI**  
DIN RAIL MODULAR CONTACTOR WIFI  
158



**ΜΕΤΡΗΤΗΣ ΡΑΓΑΣ ΜΟΝΟΦΑΣΙΚΟΣ**  
1PHASE DIN RAIL METER  
159



**ΜΕΤΡΗΤΗΣ ΡΑΓΑΣ ΨΗΦΙΑΚΟΣ ΜΟΝΟΦΑΣΙΚΟΣ**  
1PHASE DIN RAIL METER DIGITAL  
159



**ΨΗΦΙΑΚΟΣ ΜΕΤΡΗΤΗΣ ΡΕΥΜΑΤΟΣ ΡΑΓΑΣ WIFI**  
DIGITAL DIN RAIL METER WIFI  
159



**ΑΝΤΙΚΕΡΑΥΝΙΚΑ Τ1-T2-T3**  
SURGE PROTECTIVE DEVICE  
160



**ΑΝΤΙΚΕΡΑΥΝΙΚΑ Τ1-T2-T3 SOLAR**  
SURGE PROTECTIVE DEVICE DC SOLAR  
160



**ΓΕΝΙΚΟΣ ΔΙΑΚΟΠΤΗΣ ΙΣΧΥΟΣ DC**  
MOLDED CIRCUIT BREAKERS DC  
161



**ΓΕΦΥΡΕΣ ΧΑΛΚΟΥ ΜΕ ΜΟΝΩΣΗ ΤΥΠΟΥ L**  
BUSBAR COPPER WITH INSULATION TYPE L  
162



**ΓΕΦΥΡΕΣ ΧΑΛΚΟΥ ΜΕ ΜΟΝΩΣΗ ΤΥΠΟΥ U**  
BUSBAR COPPER WITH INSULATION TYPE U  
163



**ΑΥΤΟΜΑΤΕΣ ΑΣΦΑΛΕΙΕΣ ΔΙΠΟΛΙΚΕΣ**  
MINIATURE BREAKER DC 2P 6KA 500V  
165



**ΑΣΦΑΛΕΙΟΘΗΚΕΣ DC**  
FUSE BASE DC  
165



**ΑΝΤΙΚΕΡΑΥΝΙΚΑ DC**  
SURGE PROTECTIVE DC  
165



**ΔΙΑΚΟΠΤΕΣ MCCB MCB**  
MCCB MCB  
165



**ΡΕΛΕ ΙΣΧΥΟΣ ΜΕ ΠΗΝΙΟ 230V**  
AC CONTACTOR WITH COIL 230VAC  
166



**ΒΟΗΘΗΤΙΚΕΣ ΕΠΑΦΕΣ**  
AUXILIARY CONTACT  
167



**ΧΡΟΝΙΚΟ ΚΑΘΥΣΤΕΡΗΣΗΣ ΓΙΑ ΡΕΛΕ ΙΣΧΥΟΣ**  
ELECTRICITY DELAY  
167



**ΠΗΝΙΑ**  
COILS  
167



**ΑΣΦΑΛΕΙΕΣ DC**  
DC FUSES  
165



**ΘΕΡΜΙΚΑ ΓΙΑ ΡΕΛΕ ΙΣΧΥΟΣ**  
THERMAL OVERLOAD RELAY  
168



**ΘΕΡΜΟΜΑΓΝΗΤΙΚΟ ΡΑΓΑΣ**  
MOTOR PROTECTOR  
169



**ΕΠΙΤΗΡΗΤΗΣ ΤΑΣΗΣ**  
VOLTAGE PROTECTOR  
170



**ΔΙΑΚΟΠΤΕΣ ΡΕΥΜΑΤΟΣ**  
MAIN ISOLATOR SWITCH  
170



**ΔΙΑΚΟΠΤΕΣ ΡΕΥΜΑΤΟΣ**  
MAIN ISOLATOR SWITCH  
170



**ΠΙΝΑΚΕΣ PRE-WIRED DIN RAIL**  
ENCLOSURES  
172



**SMARTTHUBS WiFi ZigBee 3.0 GATEAWAY**  
SMARTTHUBS WiFi ZigBee 3.0 GATEAWAY  
174



**ΕΞΥΠΝΟΣ ΑΝΤΑΠΟΡΑΣ ΣΟΥΚΟ WIFI & ΜΕΤΡΗΤΗ ΕΝΕΡΓΕΙΑΣ**  
SMART ADAPTER SCHUKO WIFI & POWER METER  
174



**ΕΞΥΠΝΟΣ ΑΝΤΑΠΟΡΑΣ ΔΙΠΛΟΣ ΣΟΥΚΟ ΚΑΘΕΤΟΣ WIFI & ΜΕΤΡΗΤΗ ΕΝΕΡΓΕΙΑΣ**  
SMART ADAPTER DUAL VERTICAL SCHUKO WIFI & POWER METER  
174



**ΚΑΜΕΡΑ ΑΣΦΑΛΕΙΑΣ WIFI ΜΕ ΚΙΝΗΣΗ 360°**  
WiFi SECURITY CAMERA 360°  
175



**ΑΣΥΡΜΑΤΟΣ ΑΝΙΧΝΕΥΤΗΣ ΚΙΝΗΣΗΣ HOME VALUE**  
WIRELESS MOTION SENSOR PIR HOME VALUE  
176



**ΑΣΥΡΜΑΤΟΣ ΑΙΣΘΗΤΗΡΑΣ ΠΟΡΤΑΣ/ΠΑΡΑΘΥΡΟΥ**  
HOME VALUE  
WIRELESS DOOR/WINDOW SENSOR HOME VALUE  
176



**ΑΣΥΡΜΑΤΗ ΕΞΩΤΕΡΙΚΗ ΣΙΡΗΝΑ ΣΥΝΑΓΕΡΜΟΥ**  
HOME VALUE  
WIRELESS EXTERNAL ALARM SIREN HOME VALUE  
176



**ΕΞΥΠΝΗ ΚΛΕΙΔΟΘΗΚΗ ΒΛΕΤΟΟΤΗ, ΑΠΟΤΥΠΩΜΑ, ΚΩΔΙΚΟ**  
SMART KEY BOX LOCKER  
BLUETOOTH, FINGERPRINT, CODE  
177

# ΗΛΕΚΤΡΟΛΟΓΙΚΟ ΥΛΙΚΟ ELECTRICAL EQUIPMENT

ΦΙΣ ΡΕΥΜΑΤΟΣ  
POWER PLUGS

ΦΙΣ ΒΙΟΜΗΧΑΝΙΚΟΥ ΤΥΠΟΥ  
INDUSTRIAL TYPE PLUGS

ΑΝΤΑΠΤΟΡΕΣ  
ADAPTERS

ΠΡΟΕΚΤΑΣΕΙΣ  
EXTENSION CORDS

ΠΟΛΥΠΡΙΖΑ  
MULTI-SOCKETS

ΜΠΑΛΑΝΤΕΖΕΣ  
CABLE REELS

ΓΙΡΛΑΝΤΑ ΕΞΩΤΕΡΙΚΟΥ ΧΩΡΟΥ  
OUTDOOR STRING LIGHT



# NEW ECO FRIENDLY PACKAGING



Η δέσμευσή μας στην **EUROLAMP** για ένα πιο βιώσιμο μέλλον μας οδήγησε στην αλλαγή των συσκευασιών των προϊόντων μας. Επιλέξαμε υλικά που είναι ανακυκλώσιμα και φιλικά προς το περιβάλλον, μειώνοντας το αποτύπωμά μας στη φύση.

Στο εξής, τα ακόλουθα προϊόντα θα πωλούνται σε **ανακυκλώσιμη χάρτινη συσκευασία** φιλική προς το περιβάλλον

**Φις / Αντάπτορες / Πολύπριζα / Προεκτάσεις**

Our commitment at **EUROLAMP** to a more sustainable future has led us to change the packaging of our products. We chose materials that are recyclable and environmentally friendly, reducing our footprint on nature.

From now on the following products will be sold with **recyclable paper packaging** environmentally friendly

**Power Plugs / ADAPTERs / Multi-Sockets / Extension Cords**

## EUROLAMP ΣΤΑΝΤ

ΓΙΑ: ΦΙΣ / ΑΝΤΑΠΤΟΡΕΣ  
ΠΟΛΥΠΡΙΖΑ / ΠΡΟΕΚΤΑΣΕΙΣ

## EUROLAMP STAND

FOR: POWER PLUGS / ADAPTERS  
MULTI-SOCKETS / EXTENSION CORDS



- Code Stand:  
**147-99846**

- Για αυτό το σταντ πρέπει να επιλέξετε τους ακόλουθους κωδικούς:
- For this stand you must select the following codes:

147-09010	147-62107
147-10002	147-62201
147-10004	147-62202
147-10019	147-62203
147-10020	147-62211
147-10025	147-62212
147-10029	147-62213
147-13016	800-10023
147-13017	800-10024
147-13019	800-10038
147-13025	800-10039
147-13026	

- Ελάχιστη παραγγελία που απαιτείται για δωρεάν απόκτηση του stand:
- Minimum order required for free stand disposal:

147-09010	5	147-62107	5
147-10002	10	147-62201	10
147-10004	10	147-62202	10
147-10019	10	147-62203	10
147-10020	10	147-62211	10
147-10025	10	147-62212	10
147-10029	5	147-62213	10
147-13016	10	800-10023	10
147-13017	10	800-10024	10
147-13019	5	800-10038	10
147-13025	5	800-10039	10
147-13026	5		

**ΦΙΣ ΔΙΠΟΛΙΚΟ ΑΡΣΕΝΙΚΟ**  
PLUG 2 POLE NORMAL MALE

- Voltage 220-240V 50\60Hz
- Amperage 2.5A



**147-10023**  
Nylon Bag with Sticker Packaging



**800-10023**  
Recyclable Paper Packaging



Code	Barcode	Watt	Registr. No.	Color	Packing	MOQ
<b>147-10023</b>	5206139021489	600W	HMPP/01647	WHITE	1\10\50\200	10
<b>800-10023</b>	5206139099440	600W	HMPP/01647	WHITE	1\10\50\200	10

**ΦΙΣ ΔΙΠΟΛΙΚΟ ΘΗΛΥΚΟ**  
PLUG 2 POLE NORMAL FEMALE

- Voltage 220-240V 50\60Hz
- Amperage 2.5A



**147-10024**  
Nylon Bag with Sticker Packaging



**800-10024**  
Recyclable Paper Packaging



Code	Barcode	Watt	Registr. No.	Color	Packing	MOQ
<b>147-10024</b>	5206139021496	600W	HMPP/01648	WHITE	1\10\50\200	10
<b>800-10024</b>	5206139081391	600W	HMPP/01648	WHITE	1\10\50\200	10

**ΦΙΣ ΣΟΥΚΟ ΑΡΣΕΝΙΚΟ T.L.**  
PLUG SCHUKO MALE T.L.

- Voltage 220-240V 50\60Hz
- Amperage 16A



**147-10038**  
Nylon Bag with Sticker Packaging



**800-10038**  
Recyclable Paper Packaging



Code	Barcode	Watt	Registr. No.	Color	Packing	MOQ
<b>147-10038</b>	5206139021571	3500W	HMPP/02035	WHITE	1\10\50\200	10
<b>800-10038</b>	5206139027641	3500W	HMPP/02952	WHITE	1\10\50\200	10

**ΦΙΣ ΣΟΥΚΟ ΘΗΛΥΚΟ T.L. ΜΕ ΠΡΟΣΤΑΣΙΑ ΕΠΑΦΩΝ**  
PLUG SCHUKO FEMALE T.L. WITH SHUTTER PROTECTION

- Voltage 220-240V 50\60Hz
- Amperage 16A



**147-10039**  
Nylon Bag with Sticker Packaging



**800-10039**  
Recyclable Paper Packaging



Code	Barcode	Watt	Registr. No.	Color	Packing	MOQ
<b>147-10039</b>	5206139021588	3840W	HMPP/02047	WHITE	1\10\50\200	10
<b>800-10039</b>	5206139084460	3840W	HMPP/02953	WHITE	1\10\50\200	10

**ΦΙΣ ΣΟΥΚΟ ΑΡΣΕΝΙΚΟ ΠΛΑΓΙΑΣ**  
PLUG SCHUKO MALE RIGHT ANGLE

- Voltage 250V 50\60Hz
- Amperage 16A



Code	Barcode	Watt	Registr. No.	Color	Packing	MOQ
<b>147-10042</b>	5206139068118	3680W	HMPP/02038	WHITE	1\10\500	10

### ΦΙΣ ΣΟΥΚΟ ΑΡΣΕΝΙΚΟ SLIM ΠΛΑΓΙΑΣ

PLUG SCHUKO MALE SLIM RIGHT ANGLE

- Voltage 220-240V 50\60Hz
- Amperage 16A

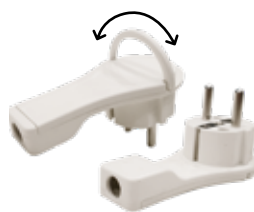

Code	Barcode	Watt	Registr. No.	Color	Packing	MOQ
147-10025	5207227048630	3680W	HMPP/02460	WHITE	1\10\200	10

### ΦΙΣ ΣΟΥΚΟ ΚΑΟΥΤΣΟΥΚ ΑΡΣΕΝΙΚΟ

PLUG SCHUKO RUBBER MALE

- Voltage 220-240V 50\60Hz
- Amperage 16A



Code	Barcode	Watt	Registr. No.	Color	Packing	MOQ
147-10032	5206139021557	3680W	HMPP/03201	BLACK	1\10\50\100	5

### ΦΙΣ ΣΟΥΚΟ ΚΑΟΥΤΣΟΥΚ ΘΗΛΥΚΟ

PLUG SCHUKO RUBBER FEMALE

- Voltage 220-240V 50\60Hz
- Amperage 16A



Code	Barcode	Watt	Registr. No.	Color	Packing	MOQ
147-10033	5206139021564	3680W	HMPP/02033	BLACK	1\10\50\100	5



**ΑΝΤΑΠΤΟΡΑΣ ΑΠΟ 1 ΣΟΥΚΟ  
ΣΕ 3 ΣΟΥΚΟ ΟΒΑΛ**  
ADAPTER FROM 1 SCHUKO  
TO 3 SCHUKO OVAL

- Voltage 220-240V 50\60Hz
- Amperage 16A

**147-10006**  
White / Λευκό



**147-10306**  
Black / Μαύρο



Code	Barcode	Watt	Registr. No.	Color	Packing	MOQ
<b>147-10006</b>	5207227022807	3680W	HMPP/03241	WHITE	1\12\48	12
<b>147-10306</b>	5207227539954	3680W	HMPP/03241	BLACK	1\12\48	12

**ΑΝΤΑΠΤΟΡΑΣ ΑΠΟ ΕΝΑ ΣΟΥΚΟ  
ΣΕ 3 ΣΟΥΚΟ ΣΤΑΥΡΟΣ ΟΡΙΖΟΝΤΙΟ**  
ADAPTER SCHUKO TO 3 SCHUKO HORIZONTAL

- Voltage 220-240V 50\60Hz
- Amperage 16A



Code	Barcode	Watt	Registr. No.	Color	Packing	MOQ
<b>147-10020</b>	5206139051233	3680W	HMPP/02547	WHITE	1\5\50\200	5

**ΑΝΤΑΠΤΟΡΑΣ ΑΠΟ 1 ΣΟΥΚΟ  
ΣΕ 2 ΣΟΥΚΟ 'ΤΑΦ'**  
ADAPTER SCHUKO TO 2 SCHUKO 'T'

- Voltage 220-240V 50\60Hz
- Amperage 16A



**147-10004**  
White / Λευκό



**147-10012**  
Black / Μαύρο



Code	Barcode	Watt	Registr. No.	Color	Packing	MOQ
<b>147-10004</b>	5206139100047	3500W	HMPP/03256	WHITE	1\10\200	10
<b>147-10012</b>	5207227103605	3500W	HMPP/03256	BLACK	1\10\200	10

**ΑΝΤΑΠΤΟΡΑΣ ΑΠΟ 1 ΣΟΥΚΟ  
ΣΕ 3 ΣΟΥΚΟ ΣΤΑΥΡΟΣ ΚΑΘΕΤΟ**  
ADAPTER SCHUKO  
TO 3 SCHUKO CROSS VERTICAL

- Voltage 220-240V 50\60Hz
- Amperage 16A



**147-10002**  
White / Λευκό



**147-10011**  
Black / Μαύρο



Code	Barcode	Watt	Registr. No.	Color	Packing	MOQ
<b>147-10002</b>	5206139100023	3500W	529/5734	WHITE	1\10\200	10
<b>147-10011</b>	5207227103575	3500W	529/5734	BLACK	1\10\200	10

**ΑΝΤΑΠΤΟΡΑΣ ΑΠΟ 1 ΣΟΥΚΟ  
ΣΕ 1 ΣΟΥΚΟ ΜΕ ΔΙΑΚΟΠΤΗ**  
ADAPTER FROM SCHUKO TO  
1 SCHUKO WITH SWITCH

- Voltage 220-240V 50\60Hz
- Amperage 16A

147-10010  
White / Λευκό



147-10310  
Black / Μαύρο



Code	Barcode	Watt	Color	Packing	MOQ
147-10010	5207227004681	3680W	WHITE	1\10\200	10
147-10310	5207227539992	3680W	BLACK	1\10\200	10

**ΑΝΤΑΠΤΟΡΑΣ ΑΠΟ 1 ΣΟΥΚΟ  
ΣΕ 2 ΣΟΥΚΟ ΜΕ ΔΙΑΚΟΠΤΗ**  
ADAPTER FROM SCHUKO TO 2 SCHUKO WITH SWITCH

- Voltage 220-240V 50\60Hz
- Amperage 16A



Code	Barcode	Watt	Color	Packing	MOQ
147-10007	5206139052346	3500W	WHITE	1\10\50\200	10

**ΑΝΤΑΠΤΟΡΑΣ ΑΠΟ 1 ΣΟΥΚΟ  
ΣΕ 3 ΣΟΥΚΟ ΜΕ ΔΙΑΚΟΠΤΗ**  
ADAPTER FROM SCHUKO TO  
3 SCHUKO WITH SWITCH

- Voltage 220-240V 50\60Hz
- Amperage 16A

147-10019  
White / Λευκό



147-10319  
Black / Μαύρο



Code	Barcode	Watt	Color	Packing	MOQ
147-10019	5206139052384	3680W	WHITE	1\5\50\200	5
147-10319	5207227540035	3680W	BLACK	1\5\50\200	5

**ΠΡΙΖΑ ΣΟΥΚΟ ΜΕ ΤΗΛΕΧΕΙΡΙΣΤΗΡΙΟ  
& ΠΡΟΣΤΑΣΙΑ ΕΠΑΦΩΝ ΣΕΤ 3 ΤΕΜ**  
SCHUKO SOCKET WITH REMOTE  
& SHUTTER PROTECTION SET 3PCS

- Voltage 250V 50\60Hz
- Amperage 10A

SET  
3 PCS



ΤΗΛΕΧΕΙΡΙΣΤΗΡΙΟ  
REMOTE CONTROL  
Εμβέλεια Λειτουργίας  
Operating Range  
< 30m  
Μπαταρία / Battery Type  
1xCR2032 3V



Code	Barcode	Watt	Color	Packing	MOQ
147-09050	5207227099342	2300W	WHITE	1\12	3

**ΑΝΤΑΠΤΟΡΑΣ ΑΠΟ 1 ΣΟΥΚΟ  
ΣΕ 2 ΑΠΛΑ ΔΙΠΟΛΙΚΑ**  
ADAPTER FROM 1 SCHUKO TO 2 NORMAL



- Voltage 220-240V 50\60Hz
- Amperage 2.5A

Code	Barcode	Watt	Registr. No.	Color	Packing	MOQ
147-10013	5206139100139	1100W	HMPP/02678	WHITE	1\10\200	10

**ΑΝΤΑΠΤΟΡΑΣ ΑΠΟ 1 ΣΟΥΚΟ  
ΣΕ 3 ΑΠΛΑ ΔΙΠΟΛΙΚΑ**  
ADAPTER FROM 1 SCHUKO TO 3 NORMAL



- Voltage 220-240V 50\60Hz
- Amperage 2.5A

Code	Barcode	Watt	Registr. No.	Color	Packing	MOQ
147-10014	5206139100146	1700W	HMPP/02677	WHITE	1\10\200	10

**ΑΝΤΑΠΤΟΡΑΣ ΑΠΟ 1 ΣΟΥΚΟ  
ΣΕ 1 ΣΟΥΚΟ & 2 ΔΙΠΟΛΙΚΑ**  
ADAPTER FROM SCHUKO TO 1 SCHUKO & 2 NORMAL



- Voltage 220-240V 50\60Hz
- Amperage 16A

Code	Barcode	Watt	Registr. No.	Color	Packing	MOQ
147-10001	5206139100016	3500W	HMPP/02592	WHITE	1\10\200	10

**ΑΝΤΑΠΤΟΡΑΣ ΑΠΟ 1 ΣΟΥΚΟ ΣΕ 2 ΣΟΥΚΟ**  
ADAPTER FROM SCHUKO TO 2 SCHUKO



- Voltage 220-240V 50\60Hz
- Amperage 16A

Code	Barcode	Watt	Registr. No.	Color	Packing	MOQ
147-10000	5206139100009	3500W	HMPP/03240	WHITE	1\10\200	10

**ΚΑΛΩΘΙ PROMO EUROLAMP**

ΓΙΑ: ΦΙΣ / ΑΝΤΑΠΤΟΡΕΣ / ΠΟΛΥΠΡΙΖΑ / ΠΡΟΕΚΤΑΣΕΙΣ

**EUROLAMP PROMO BASKET**

FOR: POWER PLUGS / ADAPTERS / MULTI-SOCKETS / EXTENSION CORDS

- Code Stand:  
147-99807



**ΑΝΤΑΠΤΟΡΑΣ ΣΟΥΚΟ  
ΜΕ ΠΡΟΣΤΑΣΙΑ ΥΠΕΡΤΑΣΗΣ & ΕΠΑΦΩΝ**  
ADAPTER SCHUKO WITH SURGE & SHUTTER PROTECTION

- Voltage 220-240V 50\60Hz
- Amperage 16A



Code	Barcode	Watt	Registr. No.	Color	Packing	MOQ
147-10029	5206139015198	3680W	HMPP/02712	BLACK	1\12\48	6

**ΑΝΤΑΠΤΟΡΑΣ ΣΟΥΚΟ  
ΜΕ ΠΡΟΣΤΑΣΙΑ ΥΠΕΡΤΑΣΗΣ & ΕΠΑΦΩΝ**  
ADAPTER SCHUKO  
WITH SURGE & SHUTTER PROTECTION

- Voltage 220-240V 50\60Hz
- Amperage 16A

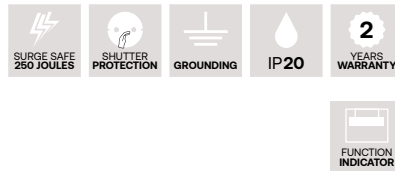

Code	Barcode	Watt	Registr. No.	Color	Packing	MOQ
147-09002	5207227018572	3500W	HMPP/02958	WHITE-GREY	1\10\40	4

**ΑΝΤΑΠΤΟΡΑΣ ΣΟΥΚΟ ΜΕ 2 ΘΥΡΕΣ USB**  
ADAPTER SCHUKO WITH 2 USB PORTS

- Voltage 220-240V 50\60Hz
- Amperage 16A
- USB 2 Ports /Θύρες, 5V DC/max - 2.4A



147-09010 Grey / Γκρι  
147-09012 Green / Πράσινο



Code	Barcode	Watt	Color	Packing	MOQ
147-09010	5207227018367	3680W	WHITE-GREY	1\10\40	4
147-09012	5207227018428	3680W	WHITE-GREEN	1\10\40	4

**ΑΝΤΑΠΤΟΡΑΣ ΣΟΥΚΟ ΜΕ 2 ΘΥΡΕΣ USB  
TYPE C & TYPE A**  
ADAPTER SCHUKO WITH 2 USB PORTS  
TYPE C & TYPE A

- Voltage 220-240V 50\60Hz
- Amperage 16A
- Type A max 18W
- Type C max 20W



Code	Barcode	Watt	Color	Packing	MOQ
147-09014	5207227569913	3680W	WHITE	1\10\40	4

# ΒΙΟΜΗΧΑΝΙΚΟΥ ΤΥΠΟΥ - INDUSTRIAL TYPE

IP44

## ΦΙΣ ΑΡΣΕΝΙΚΑ ΒΙΟΜΗΧΑΝΙΚΟΥ ΤΥΠΟΥ INDUSTRIAL TYPE MALE PLUGS

- Voltage 220-240V 50\60Hz
- Υλικό/Material PVC & COPPER



ΓΙΑ ΒΙΟΜΗΧΑΝΙΚΗ ΧΡΗΣΗ  
FOR INDUSTRIAL USE

Code	Barcode	Description	Color	Dimensions (mm)	Packing	MOQ
147-16500	5207227077098	3X16A 220-240V	BLUE & GREY	Ø50x140	1\10\100	2
147-16501	5207227077104	3X32A 220-240V	BLUE & GREY	Ø70x165	1\10\60	2
147-16502	5207227077111	4X16A 380-415V	RED & GREY	Ø70x145	1\10\60	2
147-16503	5207227077128	5X16A 380-415V	RED & GREY	Ø70x145	1\10\60	2
147-16504	5207227077135	4X32A 380-415V	RED & GREY	Ø75x160	1\10\60	2
147-16505	5207227077142	5X32A 380-415V	RED & GREY	Ø80x170	1\10\60	2

## ΦΙΣ ΘΗΛΥΚΑ ΒΙΟΜΗΧΑΝΙΚΟΥ ΤΥΠΟΥ INDUSTRIAL TYPE FEMALE PLUGS

- Voltage 220-240V 50\60Hz
- Υλικό/Material PVC & COPPER

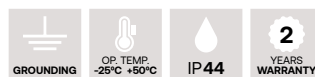

ΓΙΑ ΒΙΟΜΗΧΑΝΙΚΗ ΧΡΗΣΗ  
FOR INDUSTRIAL USE

Code	Barcode	Description	Color	Dimensions (mm)	Packing	MOQ
147-16510	5207227077159	3X16A 220-240V	BLUE & GREY	Ø80x14	1\10\100	2
147-16511	5207227077166	3X32A 220-240V	BLUE & GREY	Ø90x170	1\10\60	2
147-16512	5207227077173	4X16A 380-415V	RED & GREY	Ø90x170	1\10\60	2
147-16513	5207227077180	5X16A 380-415V	RED & GREY	Ø80x150	1\10\60	2
147-16514	5207227080005	4X32A 380-415V	RED & GREY	Ø95x170	1\10\60	2
147-16515	5207227077227	5X32A 380-415V	RED & GREY	Ø95x170	1\10\60	2

## ΠΡΙΖΕΣ ΕΠΙΤΟΙΧΕΣ ΒΙΟΜΗΧΑΝΙΚΟΥ ΤΥΠΟΥ INDUSTRIAL TYPE WALL MOUNTED SOCKETS

- Voltage 220-240V 50\60Hz
- Υλικό/Material PVC & COPPER



ΓΙΑ ΒΙΟΜΗΧΑΝΙΚΗ ΧΡΗΣΗ  
FOR INDUSTRIAL USE

Code	Barcode	Description	Color	Dimensions (mm)	Packing	MOQ
147-16520	5207227077258	3X16A 220-240V	BLUE & GREY	140x80x110	1\10\60	2
147-16521	5207227080012	3X32A 220-240V	BLUE & GREY	155x85x110	1\10\60	2
147-16522	5207227077319	4X16A 380-415V	RED & GREY	145x80x100	1\10\60	2
147-16523	5207227077340	5X16A 380-415V	RED & GREY	150x80x110	1\10\60	2
147-16524	5207227077378	4X32A 380-415V	RED & GREY	160x80x110	1\10\60	2
147-16525	5207227077388	5X32A 380-415V	RED & GREY	155x80x115	1\10\60	2

## ΠΡΟΕΚΤΑΣΗ ΔΙΠΟΛΙΚΗ ΜΕ ΠΡΟΣΤΑΣΙΑ ΕΠΑΦΩΝ

FLAT EXTENSION CORD BIPOLAR  
WITH SHUTTER PROTECTION

- Voltage 220-240V 50\60Hz
- Amperage 2.5A



2x0.75mm • 2/3/5 m

Code	Barcode	Watt	Length (m)	Color	Packing	MOQ
147-13025	5206139201256	575W	3	WHITE	1\5\50	5
147-13026	5206139201263	575W	5	WHITE	1\5\50	5

## ΠΡΟΕΚΤΑΣΗ ΣΟΥΚΟ ΜΕ ΠΡΟΣΤΑΣΙΑ ΕΠΑΦΩΝ

SCHUKO EXTENSION CORD  
WITH SHUTTER PROTECTION

- Voltage 220-240V 50\60Hz
- Amperage 16A



3x1.5mm • 2/3/5/7/10/15 m

Code	Barcode	Watt	Length (m)	Color	Packing	MOQ
147-13011	5207227095948	3680W	3	BLACK	1\5\50	5
147-13012	5207227095962	3680W	5	BLACK	1\5\30	5
147-13013	5207227276149	3680W	10	BLACK	1\5\20	3
147-13014	5207227428043	3680W	15	BLACK	1\20	3
147-13015	5207227037955	3680W	2	WHITE	1\5\50	5
147-13016	5206139201164	3680W	3	WHITE	1\5\50	5
147-13017	5206139201171	3680W	5	WHITE	1\5\30	5
147-13018	5207227106835	3680W	7	WHITE	1\5\20	3
147-13019	5206139201195	3680W	10	WHITE	1\5\20	3

## ΠΡΟΕΚΤΑΣΗ ΣΟΥΚΟ ΣΤΕΓΑΝΗ ΜΕ ΠΡΟΣΤΑΣΙΑ ΕΠΑΦΩΝ

SCHUKO EXTENSION CORD WATER RESISTANT  
WITH SHUTTER PROTECTION

- Voltage 220-240V 50\60Hz
- Amperage 16A

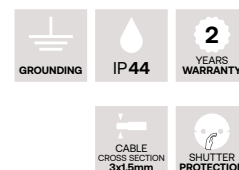

3x1.5mm • 15/20/30 m

Code	Barcode	Watt	Length (m)	Color	Packing	MOQ
147-13031	5207227276156	3680W	15	ORANGE	1\20	1
147-13032	5207227276163	3680W	20	ORANGE	1\10	1
147-13033	5207227276170	3680W	30	ORANGE	1\10	1

## ΑΞΕΣΟΥΑΡ ΤΥΛΙΞΗΣ ΠΡΟΕΚΤΑΣΕΩΝ

HANGER FOR EXTENSION CORD

- Voltage 220-240V 50\60Hz
- H125 x W17 x L480mm



Rewind max 20m cord (3G1.5mm<sup>2</sup>)

Code	Barcode	Color	Packing	MOQ
147-13080	5207227540059	YELLOW	1\10\40	1

**ΠΟΛΥΠΡΙΖΟ ΣΠΑΣΤΟ ΜΕ ΚΑΛΩΔΙΟ, ΔΙΑΚΟΠΤΗ & ΠΡΟΣΤΑΣΙΑ ΕΠΑΦΩΝ**  
**FOLDABLE POWER STRIP WITH CORD, SWITCH & SOCKET PROTECTION**



• Voltage 230V 50Hz • Amperage 16A • **3x1.5mm** • 1.5 m

- **ΑΠΟΛΥΤΗ ΕΥΕΛΙΞΙΑ ΣΤΗΝ ΔΙΑΤΑΞΗ** / ABSOLUTE FLEXIBILITY IN LAYOUT
- **ΙΔΑΝΙΚΟ ΓΙΑ ΓΡΑΦΕΙΑ** / IDEAL FOR OFFICES
- **ΚΑΛΥΤΕΡΗ ΑΙΣΘΗΤΙΚΗ ΟΡΓΑΝΩΣΗ** / BETTER AESTHETIC ORGANIZED

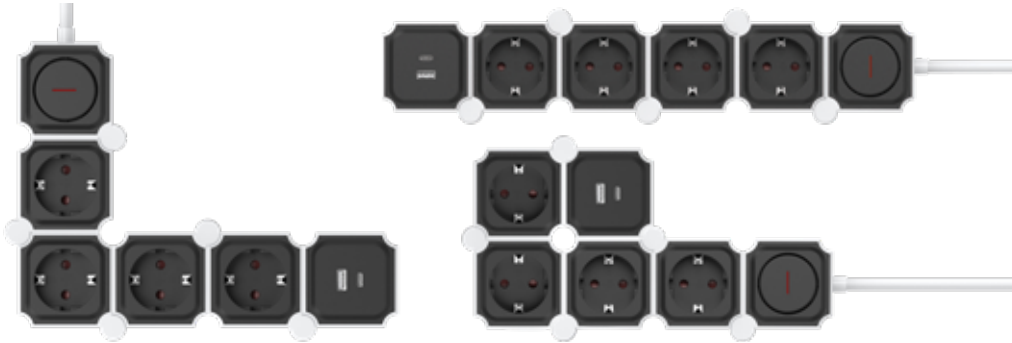

Code	Barcode	Sockets	Watt	Cable Ext.(m)	Color	Dimensions(mm) length x width x height	Packing	MOQ
147-62460	5207227540158	4	3680W	2	WHITE	355 / 60 / 40	1\4\16	4



**USB SPECS**

**Max Amperage**

5.0V DC, 3.4A, Max 17.0w

Με fast charging πρωτόκολλο

With fast charging protocol

- QC (Quick Charge)
- PD (Power Delivery)



**Type A USB:**

5.0V DC, 3.0A, Max 15.0W  
 9.0V DC, 2.0A, Max 18.0W  
 12.0V DC, 1.5A, Max 18.0W



**Type C USB:**

5.0V DC, 3.0A, Max 15.0W  
 9.0V DC, 2.22A, Max 20.0W  
 12.0V DC, 1.67A, Max 20.0W



**ΠΟΛΥΠΡΙΖΑ ΣΟΥΚΟ ΥΠΕΡΤΑΣΗΣ ΜΕ ΚΑΛΩΔΙΟ**  
**ΔΙΑΚΟΠΤΗ & ΜΕ ΠΡΟΣΤΑΣΙΑ ΕΠΑΦΩΝ**  
 SURGE PROTECTED POWER STRIP WITH CORD,  
**SWITCH & SOCKET PROTECTION**

• Voltage 220-240V 50\60Hz • Amperage 16A

3x1.5mm • 1.5 m

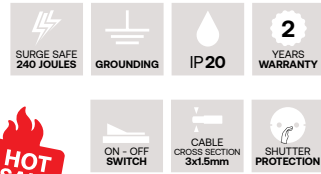

Code	Barcode	Sockets	Watt	Cable Ext.(m)	Color	Dimensions(mm) length x width x height	Packing	MOQ
147-62140	5207227540110	3+1	3680W	1.5	WHITE	280 / 80 / 65	1\20	1
147-62141	5207227540134	4+1	3680W	1.5	WHITE	320 / 80 / 65	1\20	1

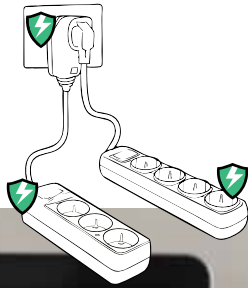

**ΠΟΛΥΠΡΙΖΑ ΣΟΥΚΟ ΜΕ ΠΡΟΣΤΑΣΙΑ ΥΠΕΡΤΑΣΗΣ**  
**ΕΠΑΦΩΝ & ΔΙΑΚΟΠΤΗ**  
 SCHUKO SOCKET WITH SURGE PROTECTION  
 SHUTTER PROTECTION & SWITCH

• Voltage 220-240V 50\60Hz  
 • Amperage 16A

3x1.5mm • 1.5 m



Code	Barcode	Sockets	Watt	Cable Ext.(m)	Color	Dimensions(mm) length x width x height	Packing	MOQ
147-62105	5206139041555	3	3500W	1.5	BLACK	240 / 53 / 40	1\40	1
147-62106	5206139041579	4	3500W	1.5	BLACK	285 / 53 / 40	1\40	1
147-62107	5206139077660	5	3500W	1.5	BLACK	330 / 53 / 40	1\30	1

**ΠΟΛΥΠΡΙΖΑ ΣΟΥΚΟ ΜΕ ΠΡΟΣΤΑΣΙΑ ΕΠΑΦΩΝ**  
SCHUKO SOCKET WITH SHUTTER PROTECTION

- Voltage 220-240V 50\60Hz
- Amperage 16A

3x1.5mm • 1.5 m

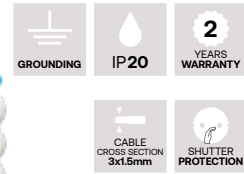

Code	Barcode	Sockets	Watt	Cable Ext.(m)	Color	Dimensions(mm) length x width x height	Packing	MOQ
147-62400	5207227291708	3	3680W	1.5	WHITE	169x55x40	1\5\80	5
147-62401	5207227291739	4	3680W	1.5	WHITE	212x55x40	1\5\60	5
147-62402	5207227291760	5	3680W	1.5	WHITE	255x55x40	1\5\40	5
147-62404	5207227291791	3	3680W	1.5	BLACK	169x55x40	1\5\80	5
147-62405	5207227291821	4	3680W	1.5	BLACK	212x55x40	1\5\60	5
147-62406	5207227291852	5	3680W	1.5	BLACK	255x55x40	1\5\40	5

**ΠΟΛΥΠΡΙΖΑ ΣΟΥΚΟ ΜΕ ΠΡΟΣΤΑΣΙΑ ΕΠΑΦΩΝ & ΔΙΑΚΟΠΤΗ**  
SCHUKO SOCKET WITH SHUTTER PROTECTION & SWITCH

- Voltage 220-240V 50\60Hz
- Amperage 16A

3x1.5mm • 1.5 m

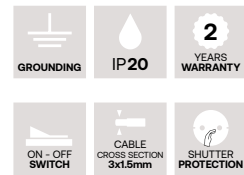

Code	Barcode	Sockets	Watt	Cable Ext.(m)	Color	Dimensions(mm) length x width x height	Packing	MOQ
147-62410	5207227291883	3	3680W	1.5	WHITE	189x55x40	1\5\80	5
147-62411	5207227291913	4	3680W	1.5	WHITE	232x55x40	1\5\60	5
147-62412	5207227291944	5	3680W	1.5	WHITE	275x55x40	1\5\40	5
147-62414	5207227291975	3	3680W	1.5	BLACK	189x55x40	1\5\80	5
147-62415	5207227292002	4	3680W	1.5	BLACK	232x55x40	1\5\60	5
147-62416	5207227292033	5	3680W	1.5	BLACK	275x55x40	1\5\40	5

**ΠΟΛΥΠΡΙΖΑ ΣΟΥΚΟ ΜΕ ΠΡΟΣΤΑΣΙΑ ΕΠΑΦΩΝ**  
SCHUKO SOCKET WITH SHUTTER PROTECTION

- Voltage 220-240V 50\60Hz
- Amperage 16A

3x1.5mm • 1.5/3/5 m

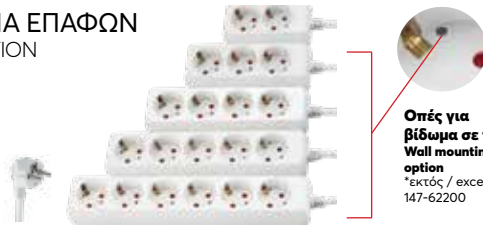

**Οπές για βίδωμα σε τοίχο**  
**Wall mounting option**  
\*εκτός / except 147-62200

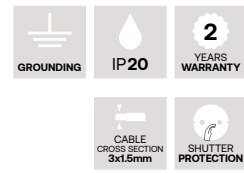

Code	Barcode	Sockets	Watt	Cable Ext.(m)	Color	Dimensions(mm) length x width x height	Packing	MOQ
147-62200*	5207227048593	2	3680W	1.5	WHITE	110/55/40	1\5\60	5
147-62201	5207227004537	3	3680W	1.5	WHITE	145/55/40	1\5\80	5
147-62202	5207227004568	4	3680W	1.5	WHITE	195/55/40	1\5\60	5
147-62203	5207227004599	5	3680W	1.5	WHITE	240/55/40	1\5\40	5
147-62204	5207227009075	6	3680W	1.5	WHITE	280/55/40	1\5\40	5
147-62220	5207227019593	3	3680W	3	WHITE	145/55/40	1\5\60	5
147-62221	5207227019623	4	3680W	3	WHITE	195/55/40	1\5\40	5
147-62222	5207227029806	5	3680W	3	WHITE	240/55/40	1\5\40	5
147-62223	5207227020841	6	3680W	3	WHITE	280/55/40	1\5\20	5
147-62240	5207227030956	3	3680W	5	WHITE	145/55/40	1\5\40	5
147-62241	5207227009105	4	3680W	5	WHITE	195/55/40	1\5\30	5
147-62242	5207227020872	5	3680W	5	WHITE	240/55/40	1\5\30	5
147-62243	5207227072628	6	3680W	5	WHITE	280/55/40	1\5\30	5

**ΠΟΛΥΠΡΙΖΑ ΣΟΥΚΟ ΜΕ ΠΡΟΣΤΑΣΙΑ ΕΠΑΦΩΝ & ΔΙΑΚΟΠΤΗ**  
SCHUKO SOCKET WITH SHUTTER PROTECTION & SWITCH

- Voltage 220-240V 50\60Hz
- Amperage 16A

3x1.5mm • 1.5/3/5 m



**Οπές για βίδωμα σε τοίχο**  
Wall mounting option

\*εκτός / except 147-62210

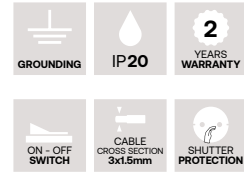

Code	Barcode	Sockets	Watt	Cable Ext.(m)	Color	Dimensions(mm) length x width x height	Packing	MOQ
147-62210*	5207227009334	2	3680W	1.5	WHITE	140/55/40	1\5\60	5
147-62211	5207227008221	3	3680W	1.5	WHITE	175/55/40	1\5\80	5
147-62212	5207227008252	4	3680W	1.5	WHITE	225/55/40	1\5\60	5
147-62213	5207227008283	5	3680W	1.5	WHITE	270/55/40	1\5\40	5
147-62214	5207227004650	6	3680W	1.5	WHITE	310/55/40	1\5\40	5
147-62230	5207227019715	3	3680W	3	WHITE	175/55/40	1\5\60	5
147-62231	5207227019746	4	3680W	3	WHITE	225/55/40	1\5\40	5
147-62232	5207227009136	5	3680W	3	WHITE	270/55/40	1\5\40	5
147-62233	5207227072710	6	3680W	3	WHITE	310/55/40	1\5\40	5
147-62250	5207227009167	3	3680W	5	WHITE	175/55/40	1\5\40	5
147-62251	5207227019777	4	3680W	5	WHITE	225/55/40	1\5\30	5
147-62252	5207227004629	5	3680W	5	WHITE	270/55/40	1\5\40	5
147-62253	5207227072741	6	3680W	5	WHITE	310/55/40	1\5\40	5

**ΠΟΛΥΠΡΙΖΑ ΣΟΥΚΟ ΜΕ ΠΡΟΣΤΑΣΙΑ ΕΠΑΦΩΝ & ΔΙΑΚΟΠΤΗ**  
SCHUKO SOCKET WITH SHUTTER PROTECTION & SWITCH

- Voltage 220-240V 50\60Hz
- Amperage 16A

3x1.5mm • 1.5 m

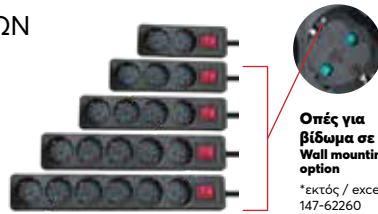

**Οπές για βίδωμα σε τοίχο**  
Wall mounting option

\*εκτός / except 147-62260

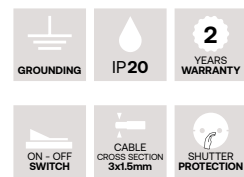

Code	Barcode	Sockets	Watt	Cable Ext.(m)	Color	Dimensions(mm) length x width x height	Packing	MOQ
147-62260*	5207227072659	2	3680W	1.5	BLACK	140 / 55 / 40	1\5\60	5
147-62261	5207227019654	3	3680W	1.5	BLACK	175 / 55 / 40	1\5\80	5
147-62262	5207227029776	4	3680W	1.5	BLACK	225 / 55 / 40	1\5\60	5
147-62263	5207227019685	5	3680W	1.5	BLACK	270 / 55 / 40	1\5\40	5
147-62264	5207227072680	6	3680W	1.5	BLACK	310 / 55 / 40	1\5\40	5

**ΠΟΛΥΠΡΙΖΑ ΣΟΥΚΟ ΜΕ ΠΡΟΣΤΑΣΙΑ ΕΠΑΦΩΝ & ΔΙΑΚΟΠΤΗ**  
SCHUKO SOCKET WITH SHUTTER PROTECTION & SWITCH

- Voltage 220-240V 50\60Hz
- Amperage 16A

3x1.5mm • 2 m

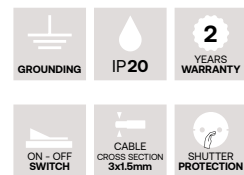

Code	Barcode	Sockets	Watt	Cable Ext.(m)	Color	Dimensions(mm) length x width x height	Packing	MOQ
147-62075	5207227540080	4	3680W	2	SILVER	225 / 55 / 40	1\5\60	5
147-62072	5206139021687	4	3680W	2	BLUE	225 / 55 / 40	1\5\60	5
147-62074	5206139021700	4	3680W	2	BLACK	225 / 55 / 40	1\5\60	5

NEW

### ΠΟΛΥΠΡΙΖΑ ΣΟΥΚΟ ΧΩΡΙΣ ΚΑΛΩΔΙΟ ΜΕ ΠΡΟΣΤΑΣΙΑ ΕΠΑΦΩΝ

SCHUKO SOCKET WITHOUT CABLE WITH SHUTTER PROTECTION

- Voltage 220-240V 50\60Hz
- Amperage 16A

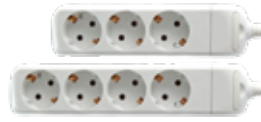

Code	Barcode	Sockets	Watt	Color	Dimensions(mm) length x width x height	Packing	MOQ
147-62020	5206139009135	3	3680W	WHITE	215 / 50 / 45	1\5\80	5
147-62021	5206139009142	4	3680W	WHITE	260 / 50 / 45	1\5\80	5

### ΠΟΛΥΠΡΙΖΑ ΣΟΥΚΟ ΧΩΡΙΣ ΚΑΛΩΔΙΟ ΜΕ ΠΡΟΣΤΑΣΙΑ ΕΠΑΦΩΝ & ΔΙΑΚΟΠΤΗ

SCHUKO SOCKET WITHOUT CABLE WITH SHUTTER PROTECTION & ON-OFF SWITCH

- Voltage 220-240V 50\60Hz
- Amperage 16A

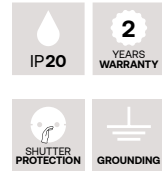

Code	Barcode	Sockets	Watt	Color	Dimensions(mm) length x width x height	Packing	MOQ
147-62025	5206139009159	3	3680W	WHITE	240 / 50 / 45	1\5\80	5
147-62026	5206139009166	4	3680W	WHITE	285 / 50 / 45	1\5\80	5

### ΠΟΛΥΠΡΙΖΟ ΣΟΥΚΟ ΜΕ ΚΑΛΩΔΙΟ & ΠΡΟΣΤΑΣΙΑ ΕΠΑΦΩΝ

SCHUKO SOCKET WITH CABLE & SHUTTER PROTECTION

- Voltage 220-240V 50\60Hz
- Amperage 16A

3x1.5mm • 1.5m

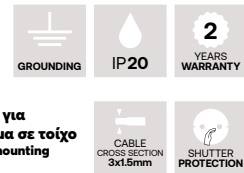

Code	Barcode	Sockets	Watt	Color	Dimensions(mm) length x width x height	Packing	MOQ
147-62206	5207227548765	3	3680W	WHITE	145 / 55 / 40	1\5\80	5

### ΠΟΛΥΠΡΙΖΟ ΣΟΥΚΟ ΜΕ ΠΡΟΣΤΑΣΙΑ ΕΠΑΦΩΝ & ΔΙΑΚΟΠΤΗ

SCHUKO SOCKET WITH SHUTTER PROTECTION & SWITCH

- Voltage 220-240V 50\60Hz
- Amperage 16A

3x1.5mm • 1.5m

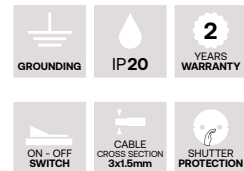

Code	Barcode	Sockets	Watt	Color	Dimensions(mm) length x width x height	Packing	MOQ
147-62216	5207227548796	3	3680W	WHITE	175 / 55 / 40	1\5\80	5

### ΠΟΛΥΠΡΙΖΑ ΣΟΥΚΟ ΣΤΕΓΑΝΑ ΚΑΟΥΤΣΟΥΚ ΧΩΡΙΣ ΚΑΛΩΔΙΟ

SCHUKO SOCKET WITH RUBBER COVER WITHOUT CABLE

- Voltage 220-240V 50\60Hz
- Amperage 16A

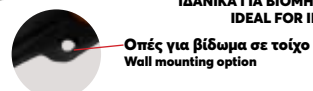

ΙΔΑΝΙΚΑ ΓΙΑ ΒΙΟΜΗΧΑΝΙΚΗ ΧΡΗΣΗ  
IDEAL FOR INDUSTRIAL USE

Code	Barcode	Sockets	Watt	Registr. No.	Color	Dimensions(mm) length x width x height	Packing	MOQ
147-16203	5207227123191	2	3680W	IS EXPECTED	BLACK	195 / 65 / 50	1\8\144	1
147-16204	5207227122873	3	3680W	IS EXPECTED	BLACK	250 / 65 / 50	1\7\126	1
147-16205	5207227123207	3	3680W	IS EXPECTED	ORANGE	250 / 65 / 50	1\7\126	1

**ΠΟΛΥΠΡΙΖΑ ΣΟΥΚΟ ΣΤΕΓΑΝΑ  
ΜΕ ΠΡΟΣΤΑΣΙΑ ΕΠΑΦΩΝ  
& ΔΙΑΚΟΠΤΗ**

WATER PROOF SCHUKO SOCKET  
WITH SHUTTER PROTECTION  
& ON-OFF SWITCH

- Voltage 220-240V 50\60Hz
- Amperage 16A

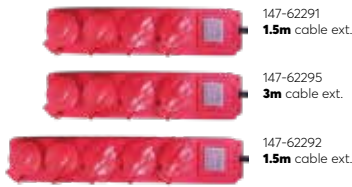

**Οπές για  
βίδωμα σε  
τοιχώ**  
Wall mounting  
option



**ΙΔΑΝΙΚΑ ΓΙΑ ΒΙΟΜΗΧΑΝΙΚΗ ΧΡΗΣΗ  
IDEAL FOR INDUSTRIAL USE**

**3x1.5mm • 1.5/3 m**

Code	Barcode	Sockets	Watt	Cable Ext.(m)	Color	Dimensions(mm) length x width x height	Packing	MOQ
147-62291	5207227009402	4	3680W	1.5	RED	335 / 70 / 60	1\30	3
147-62295	5207227011825	4	3680W	3	RED	335 / 70 / 60	1\30	3
147-62292	5207227014772	5	3680W	1.5	RED	390 / 70 / 60	1\30	3

**ΠΡΙΖΑ ΕΞΩΤΕΡΙΚΗ ΚΑΟΥΤΣΟΥΚ ΜΟΝΗ  
OUTDOOR WALL MOUNTED SCHUKO SOCKET  
WITH RUBBER COVER SINGLE**

- Voltage 220-240V 50\60Hz
- Amperage 16A



**Οπές για  
βίδωμα σε  
τοιχώ**  
Wall mounting  
option



**ΙΔΑΝΙΚΑ ΓΙΑ ΒΙΟΜΗΧΑΝΙΚΗ ΧΡΗΣΗ  
IDEAL FOR INDUSTRIAL USE**

Code	Barcode	Sockets	Watt	Registr. No.	Color	Dimensions(mm)	Packing	MOQ
147-16202	5207227123184	1	3680W	IS EXPECTED	BLACK	95 / 65 / 50	1\12\216	1

**ΒΟΞ ΣΤΕΓΑΝΟΠΟΙΗΣΗΣ ΓΙΑ ΣΟΥΚΟ ΦΙΣ  
SEALING WATERPROOF BOX FOR SCHUKO**

- Υλικό/Material POLYPROPYLENE



- ΠΕΡΙΒΛΗΜΑ ΓΙΑ ΑΔΙΑΒΡΟΧΗ ΣΥΝΔΕΣΗ ΡΕΥΜΑΤΟΣ / HOUSING COVER FOR WATERPROOF POWER CONNECTION
- ΙΔΑΝΙΚΟ ΓΙΑ ΕΣΩΤΕΡΙΚΗ & ΕΞΩΤΕΡΙΚΗ ΧΡΗΣΗ / IDEAL FOR INDOOR & OUTDOOR USE
- ΔΥΟ ΕΛΑΣΤΙΚΕΣ (ΛΑΣΤΙΧΕΝΙΕΣ) ΣΤΕΓΑΝΟΠΟΙΗΣΕΙΣ ΓΙΑ ΤΗΝ ΕΙΣΟΔΟ & ΕΞΟΔΟ ΤΟΥ ΚΑΛΩΔΙΟΥ / TWO RUBBER SEALS FOR THE CABLE IN & OUT

Code	Barcode	Color	Weight(kg)	Dimensions(mm)	Packing	MOQ
147-62095	5207227000058	ORANGE	0.13	210 x Ø70	1/50	5

**ΜΠΑΛΑΝΤΕΖΑ ΣΥΝΕΡΓΕΙΟΥ ΜΕ ΚΑΛΩΔΙΟ & ΔΙΑΚΟΠΤΗ  
WORKING LAMP WITH CABLE EXTENSION & POWER SWITCH**

- Voltage 220-240V 50\60Hz
- Amperage 16A

**2x0.75mm • 5 m**



Code	Barcode	Bulb Type & Watt	Cable Ext.(m)	Color	Dimensions(mm)	Packing	MOQ
147-47000	5206139440006	E27 / max 10W LED	5	ORANGE	Ø91x410	1\30	1

**ΜΠΑΛΑΝΤΕΖΑ ΜΕ ΠΡΟΣΤΑΣΙΑ ΥΠΕΡΘΕΡΜΑΝΣΗΣ  
& ΕΠΑΦΩΝ**

CABLE REEL WITH OVER HEAT & SHUTTER PROTECTION

- Voltage 220-240V 50\60Hz
- Amperage 13.91A

**3x1.5mm • 3 m**

**4 ΣΟΥΚΟ/SCHUKO**

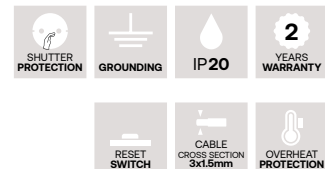

Code	Barcode	Sockets	Watt	Cable Ext.(m)	Color	Dimensions(mm)	Packing	MOQ
147-47040	5206139084163	4	3200W	3	BLACK-YELLOW	220 / 70 / 190	1\20	1

### ΜΠΑΛΑΝΤΕΖΑ ΜΕ ΠΡΟΣΤΑΣΙΑ ΥΠΕΡΘΕΡΜΑΝΣΗΣ & ΕΠΑΦΩΝ

CABLE REEL WITH OVER HEAT & SHUTTER PROTECTION

- Voltage 220-240V 50\60Hz
- Amperage 13.91A

3x1.5mm • 5/10/15 m

4 ΣΟΥΚΟ/SCHUKO

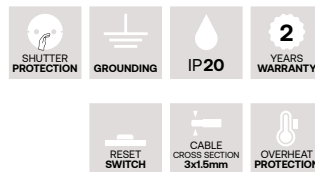

Code	Barcode	Sockets	Watt	Cable Ext.(m)	Color	Dimensions(mm)	Packing	MOQ
147-47041	5206139088079	4	3200W	5	RED-YELLOW	220 / 75 / 275	1\10	1
147-47042	5206139088376	4	3200W	10	RED-YELLOW	220 / 75 / 275	1\10	1
147-47043	5206139088796	4	3200W	15	RED-YELLOW	220 / 95 / 27.5	1\10	1

### ΜΠΑΛΑΝΤΕΖΑ ΚΑΡΟΥΛΙ ΜΕ ΠΡΟΣΤΑΣΙΑ ΥΠΕΡΘΕΡΜΑΝΣΗΣ & ΕΠΑΦΩΝ ΧΩΡΙΣ ΚΑΛΩΔΙΟ MAX 50M

CABLE REEL COIL WITH OVER HEAT & SHUTTER PROTECTION WITHOUT CABLE MAX 50M

- Voltage 250V 50\60Hz
- Amperage 16A

4 ΣΟΥΚΟ/SCHUKO



Code	Barcode	Sockets	Watt	Color	Dimensions(mm)	Packing	MOQ
147-47080	5207227074714	4	3600W	BLACK	180x299x380	1\1	1

### ΜΠΑΛΑΝΤΕΖΑ ΧΛΟΟΚΟΠΤΙΚΟΥ ΜΕ ΠΡΟΣΤΑΣΙΑ ΥΠΕΡΘΕΡΜΑΝΣΗΣ & ΕΠΑΦΩΝ ΧΩΡΙΣ ΚΑΛΩΔΙΟ MAX 30M

CABLE REEL FOR LAWN MOWER WITH OVER HEAT & SHUTTER PROTECTION WITHOUT CABLE MAX 30M

- Voltage 250V 50\60Hz
- Amperage 16A

4 ΣΟΥΚΟ/SCHUKO



Code	Barcode	Sockets	Watt	Color	Dimensions(mm)	Packing	MOQ
147-47081	5207227293092	4	3000W	ORANGE - BLACK	320x170x250	1\4	1

### ΜΠΑΛΑΝΤΕΖΑ ΚΑΡΟΥΛΙ ΜΕ ΠΡΟΣΤΑΣΙΑ ΥΠΕΡΘΕΡΜΑΝΣΗΣ & ΕΠΑΦΩΝ CABLE REEL COIL . WITH OVER HEAT & SHUTTER PROTECTION

- Voltage 220-240V 50\60Hz
- Amperage 16A

1 ΣΟΥΚΟ/SCHUKO

3x1.5mm • 27+3 m

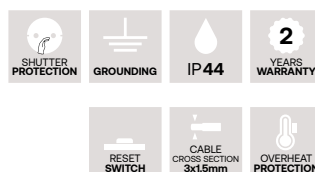

Code	Barcode	Sockets	Watt	Cable Ext.(m)	Color	Dimensions(mm)	Packing	MOQ
147-47049	5207227072789	1	3200W	27+3	RED-BLACK	350x210x280	1\1	1



**ΜΠΑΛΑΝΤΕΖΑ ΚΑΡΟΥΛΙ**  
**ΜΕ ΠΡΟΣΤΑΣΙΑ ΥΠΕΡΘΕΡΜΑΝΣΗΣ & ΕΠΑΦΩΝ**  
 CABLE REEL COIL . WITH OVER HEAT & SHUTTER PROTECTION

- Voltage 220-240V 50\60Hz
- Amperage 13.91A

**4 ΣΟΥΚΟ/SCHUKO**

**3x2.5mm • 30/50 m**

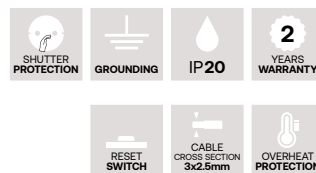

Code	Barcode	Sockets	Watt	Cable Ext.(m)	Color	Dimensions(mm)	Packing	MOQ
147-47031	5207227048609	4	3200W	30	BLACK-YELLOW	265x175x370	1\1	1
147-47032	5207227427176	4	3200W	50	BLACK-YELLOW	265x175x370	1\1	1

**ΜΠΑΛΑΝΤΕΖΑ ΚΑΡΟΥΛΙ**  
**ΜΕ ΠΡΟΣΤΑΣΙΑ ΥΠΕΡΘΕΡΜΑΝΣΗΣ & ΕΠΑΦΩΝ**  
 CABLE REEL COIL . WITH OVER HEAT & SHUTTER PROTECTION

- Voltage 220-240V 50\60Hz
- Amperage 16A

**4 ΣΟΥΚΟ/SCHUKO**

**3x1.5mm • 15/25/50 m**

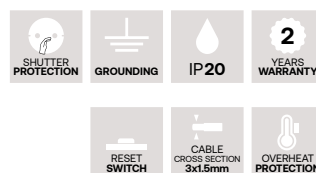

Code	Barcode	Sockets	Watt	Cable Ext.(m)	Color	Dimensions(mm)	Packing	MOQ
147-47044	5206139088970	4	3200W	15	BLACK-YELLOW	270x160x210	1\1	1
147-47045	5206139089038	4	3200W	25	BLACK-YELLOW	320x170x250	1\1	1
147-47025	5206139110152	4	3200W	50	BLACK-YELLOW	350x200x280	1\1	1

**ΜΠΑΛΑΝΤΕΖΑ ΚΑΡΟΥΛΙ**  
**ΜΕ ΠΡΟΣΤΑΣΙΑ ΥΠΕΡΘΕΡΜΑΝΣΗΣ & ΕΠΑΦΩΝ**  
 CABLE REEL COIL . WITH OVER HEAT & SHUTTER PROTECTION

- Voltage 230V 50\60Hz
- Amperage 13A

**4 ΣΟΥΚΟ/SCHUKO**

**3x1.5mm • 15 m**

ΚΟΥΜΠΙ  
 ΑΥΤΟΜΑΤΗΣ ΤΥΛΙΞΗΣ  
 Reel Easy Technology  
 Button

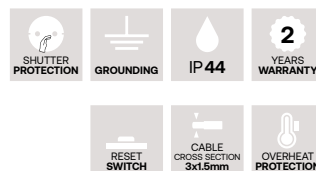

Code	Barcode	Sockets	Watt	Cable Ext.(m)	Color	Dimensions(mm)	Packing	MOQ
147-47200	5207227063435	4	1000W 3000W	15	YELLOW-BLACK	305x180x345	1\2	1

**ΜΠΑΛΑΝΤΕΖΑ ΚΑΡΟΥΛΙ**  
**ΜΕ ΠΡΟΣΤΑΣΙΑ ΥΠΕΡΘΕΡΜΑΝΣΗΣ & ΕΠΑΦΩΝ**  
 CABLE REEL COIL . WITH OVER HEAT & SHUTTER PROTECTION

- Voltage 230V 50\60Hz
- Amperage 16A

**4 ΣΟΥΚΟ/SCHUKO**

**3x1.5mm • 8+2 m**



ΦΩΤΕΙΝΗ  
 ΕΝΔΕΙΞΗ  
 ΣΤΑΣΗΣ  
 ΛΕΙΤΟΥΡΓΙΑΣ  
 Light indicator  
 of Good Operation

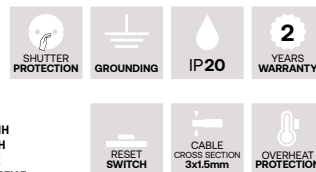

Code	Barcode	Sockets	Watt	Cable Ext.(m)	Color	Dimensions(mm)	Packing	MOQ
147-47201	5207227063459	1	1000W 3000W	8+2	BLUE	285x170x335	1\2	1

**ΓΙΡΛΑΝΤΑ ΕΞΩΤΕΡΙΚΟΥ ΧΩΡΟΥ**  
**10m ΜΕ 10 ΝΤΟΥΪ. ΕΠΕΚΤΕΙΝΟΜΕΝΗ**  
 OUTDOOR STRING LIGHT  
 10M WITH 10 LAMP HOLDERS. EXTENDABLE

- Voltage 220-240V 50\60Hz
- Amperage 16A
- **2x1.0mm** • 10+1 m

**10xE27** ΝΤΟΥΪ / LAMP HOLDERS

**ΙΔΑΝΙΚΟ ΓΙΑ ΧΡΗΣΗ ΣΕ ΕΞΩΤΕΡΙΚΟΥΣ ΧΩΡΟΥΣ**  
**IDEAL FOR OUTDOOR USE**

**ΣΥΝΔΥΑΖΕΤΑΙ ΜΕ / COMBINED WITH**  
 147-78253, 147-78263, 147-77500, 147-77501, 147-77502

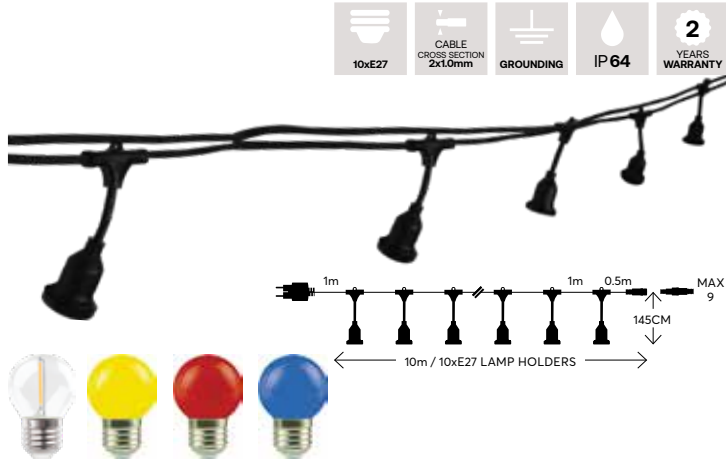

Code	Barcode	Watt	Bulb Type & Watt	Cable Ext.(m)	Color	Packing	MOQ
147-47090	5207227026850	2000W	10xE27 / max 10W LED	10+1	BLACK	1\4	1

**ΓΙΡΛΑΝΤΑ ΕΞΩΤΕΡΙΚΟΥ ΧΩΡΟΥ**  
**10m ΜΕ 20 ΝΤΟΥΪ. ΕΠΕΚΤΕΙΝΟΜΕΝΗ**  
 OUTDOOR STRING LIGHT  
 10M WITH 20 LAMP HOLDERS. EXTENDABLE

- Voltage 220-240V 50\60Hz
- Amperage 16A
- **2x1.0mm** • 10+1 m

**20xE27** ΝΤΟΥΪ / LAMP HOLDERS

**ΙΔΑΝΙΚΟ ΓΙΑ ΧΡΗΣΗ ΣΕ ΕΞΩΤΕΡΙΚΟΥΣ ΧΩΡΟΥΣ**  
**IDEAL FOR OUTDOOR USE**

**ΣΥΝΔΥΑΖΕΤΑΙ ΜΕ / COMBINED WITH**  
 147-78253, 147-78263, 147-77500, 147-77501, 147-77502

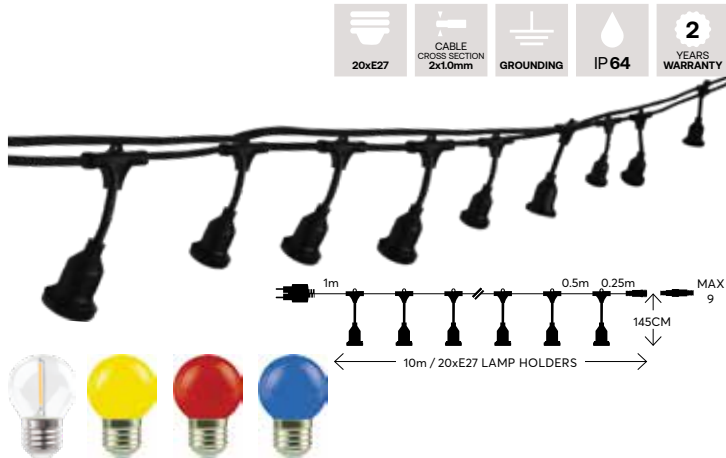

Code	Barcode	Watt	Bulb Type & Watt	Cable Ext.(m)	Color	Packing	MOQ
147-47091	5207227240393	2000W	20xE27 / max 10W LED	10+1	BLACK	1\4	1





## **UK TYPE**

ΦΙΣ ΡΕΥΜΑΤΟΣ  
**POWER PLUGS**

ΑΝΤΑΠΤΟΡΕΣ  
**ADAPTERS**

ΠΡΟΕΚΤΑΣΕΙΣ  
**EXTENSION CORDS**

ΠΟΛΥΠΡΙΖΑ  
**MULTI-SOCKETS**

ΜΠΑΛΑΝΤΕΖΕΣ  
**CABLE REELS**

**ΦΙΣ ΡΕΥΜΑΤΟΣ ΑΡΣΕΝΙΚΟ ΤΥΠΟΥ UK**  
PLUG NORMAL MALE TYPE UK



- Voltage 220-240V 50\60Hz
- Amperage 13A

Code	Barcode	Watt	Standards	Color	Packing	MOQ
147-10021	5206139067920	3120W	BS1363	WHITE	1\50\200	10

**ΦΙΣ ΡΕΥΜΑΤΟΣ ΘΗΛΥΚΟ ΤΥΠΟΥ UK**  
PLUG NORMAL FEMALE TYPE UK



- Voltage 220-240V 50\60Hz
- Amperage 13A

Code	Barcode	Watt	Standards	Color	Packing	MOQ
147-10022	5206139067937	3120W	BS1363	WHITE	1\50\200	10

**ΑΝΤΑΠΤΟΡΑΣ ΑΠΟ UK ΣΕ ΣΟΥΚΟ**  
**ΜΕ ΠΡΟΣΤΑΣΙΑ ΕΠΑΦΩΝ**  
UK TYPE ADAPTER TO SCHUKO WITH  
SHUTTER PROTECTION



- Voltage 220-240V 50\60Hz
- Amperage 13A

Code	Barcode	Watt	Fuse	Color	Packing	MOQ
147-09103	5207227072468	2860W	13A BS1362	WHITE	1\10\200	4

**ΧΡΟΝΟΔΙΑΚΟΠΤΗΣ ΠΡΙΖΑΣ ΤΥΠΟΥ UK**  
TIMER SWITCH TYPE UK TYPE



- Voltage 220-240V 50\60Hz
- Amperage 13A

Code	Barcode	Watt	Timer	Standards	Color	Packing	MOQ
147-35002	5207227201950	3120W	24h. min. set. time: 15'	BS 5733: 2010	WHITE	1\20\80	10

**ΤΑΞΙΔΙΩΤΙΚΟΣ ΑΝΤΑΠΤΟΡΑΣ**  
**ΑΠΟ SCHUKO ΣΕ UK ΜΕ ΠΡΟΣΤΑΣΙΑ ΕΠΑΦΩΝ**  
TRAVEL ADAPTER SCHUKO TO UK TYPE WITH SHUTTER PROTECTION



- Voltage 220-240V 50\60Hz
- Amperage 10A

Code	Barcode	Watt	Color	Packing	MOQ
147-09105	5207227142703	2860W	WHITE	1\50\300	1

**ΑΝΤΑΠΤΟΡΑΣ UK**  
**3 ΘΕΣΕΩΝ ΜΕ ΠΡΟΣΤΑΣΙΑ ΕΠΑΦΩΝ**  
ADAPTER UK TYPE 3 SOCKETS WITH SHUTTER PROTECTION



- Voltage 220-240V 50\60Hz
- Amperage 13A

Code	Barcode	Watt	Fuse	Color	Packing	MOQ
147-10017	5206139067913	3120W	13A BS1362	WHITE	1\50\200	5

## ΑΝΤΑΠΤΟΡΑΣ ΑΠΟ UK ΣΕ ΔΙΠΟΛΙΚΟ ADAPTER UK TYPE TO TYPE C

- Voltage 250V 50\60Hz
- Amperage 3A



147-09106



147-09107



Code	Barcode	Watt	Fuse	Color	Packing	MOQ
147-09106	5207227175237	750W	3A BS1362	WHITE	1\20\200	20
147-09107	5207227175268	750W	3A BS1362	BLACK	1\20\200	20

## ΑΝΤΑΠΤΟΡΑΣ ΑΠΟ UK ΣΕ SCHUKO ADAPTER UK TO SCHUKO

- Voltage 250V 50\60Hz
- Amperage 13A



147-09108



147-09109



Code	Barcode	Watt	Fuse	Color	Packing	MOQ
147-09108	5207227175299	3250W	13A BS1362	WHITE	1\20\200	20
147-09109	5207227175312	3250W	13A BS1362	BLACK	1\20\200	20

## ΠΟΛΥΠΡΙΖΟ UK ΜΕ ΠΡΟΣΤΑΣΙΑ ΕΠΑΦΩΝ UK TYPE MULTI SOCKET WITH SHUTTER PROTECTION

- Voltage 220-240V 50\60Hz
- Amperage 13A

3x1.25mm • 3m



Code	Barcode	Sockets	Watt	Cable Ext.(m)	Color	Dimensions(mm)	Packing	MOQ
147-62300	5206139067852	2 UK	3120W	3	WHITE	275x100x50	1\40	1
147-62302	5206139067869	4 UK	3120W	3	WHITE	325x105x50	1\40	1

## ΠΟΛΥΠΡΙΖΟ UK ΜΕ ΠΡΟΣΤΑΣΙΑ ΕΠΑΦΩΝ & ΔΙΑΚΟΠΤΕΣ UK TYPE MULTI SOCKET WITH SHUTTER PROTECTION & SWITCHES

- Voltage 220-240V 50\60Hz
- Amperage 13A

3x1.25mm • 3m



Code	Barcode	Sockets	Watt	Cable Ext.(m)	Color	Dimensions(mm)	Packing	MOQ
147-62312	5206139006639	4 UK	3120W	3	WHITE	350x100x50	1\40	1
147-62314	5206139019011	6 UK	3120W	3	WHITE	475x95x50	1\30	1

## ΠΟΛΥΠΡΙΖΟ UK ΜΕ ΠΡΟΣΤΑΣΙΑ ΕΠΑΦΩΝ & ΠΡΟΣΤΑΣΙΑ ΥΠΕΡΤΑΣΗΣ UK TYPE MULTI SOCKET WITH SHUTTER & SURGE PROTECTION

- Voltage 220-240V 50\60Hz
- Amperage 13A

3x1.25mm • 3m



Code	Barcode	Sockets	Watt	Cable Ext.(m)	Color	Dimensions(mm)	Packing	MOQ
147-62350	5206139067876	2 UK	3120W	3m	WHITE	275x100x50	1\40	1
147-62352	5206139067883	4 UK	3120W	3m	WHITE	325x105x50	1\40	1

## ΠΡΟΕΚΤΑΣΗ UK ΜΕ ΠΡΟΣΤΑΣΙΑ ΕΠΑΦΩΝ

### EXTENSION UK TYPE WITH SHUTTER PROTECTION

- Voltage 220-240V 50\60Hz
- Amperage 13A

3x1.25mm • 3/5m



Code	Barcode	Watt	Fuse	Cable Ext.(m)	Color	Packing	MOQ
147-13041	5206139067890	3120W	13A BS1362	3	WHITE	1\5\50	5
147-13042	5206139067906	3120W	13A BS1362	5	WHITE	1\5\50	5

## ΜΠΑΛΑΝΤΕΖΑ UK

### ΜΕ ΠΡΟΣΤΑΣΙΑ ΥΠΕΡΘΕΡΜΑΝΣΗΣ & ΕΠΑΦΩΝ

### UK TYPE CABLE REEL WITH OVER HEAT & SHUTTER PROTECTION

- Voltage 220-240V 50\60Hz
- Amperage 13A

3x1.5mm • 5/10/15m

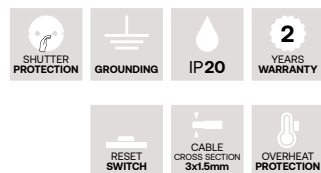

Code	Barcode	Sockets	Watt	Standards	Cable Ext.(m)	Color	Packing	MOQ
147-47311	5207227153402	4 UK	3120W	BS1363-2	5	Blue - Yellow	1/1	1

## ΜΠΑΛΑΝΤΕΖΑ ΚΑΡΟΥΛΙ UK

### ΜΕ ΠΡΟΣΤΑΣΙΑ ΥΠΕΡΘΕΡΜΑΝΣΗΣ & ΕΠΑΦΩΝ

### UK TYPE CABLE REEL WITH OVER HEAT & SHUTTER PROTECTION

- Voltage 220-240V 50\60Hz
- Amperage 13A

3x1.5mm • 25/50m

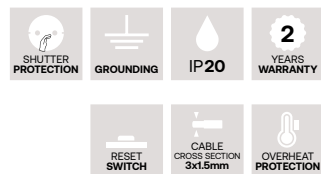

Code	Barcode	Sockets	Watt	Standards	Cable Ext.(m)	Color	Packing	MOQ
147-47320	5207227153457	4 UK	3120W	BS1363	25	ORANGE - BLACK	1/10	1

## ΑΞΕΣΟΥΑΡ ΤΥΛΙΕΗΣ ΠΡΟΕΚΤΑΣΕΩΝ

### EXTENSION CORD HANGER

- Voltage 220-240V 50\60Hz
- H125 x W17 x L480mm

Rewind max 20m cord (3G1.5mm<sup>2</sup>)



Code	Barcode	Color	Packing	MOQ
147-13080	5207227540059	YELLOW	1\10\40	1



**ΚΤΙΡΙΑΚΟΣ  
ΕΞΟΠΛΙΣΜΟΣ  
BUILDING  
EQUIPMENT**

**ΑΝΙΧΝΕΥΤΕΣ  
DETECTORS**

**ΦΩΤΟΚΥΤΤΑΡΑ  
PHOTOCELL**

**ΚΟΥΔΟΥΝΙΑ & ΜΠΟΥΤΟΝ  
DOORBELLS & PUSH BUTTONS**

**ΘΕΡΜΟΣΤΑΤΕΣ ΧΩΡΟΥ & ΘΕΡΜΟΣΙΦΩΝΟΥ  
ROOM & WATER HEATER THERMOSTATS**

**ΑΝΙΧΝΕΥΤΕΣ ΚΙΝΗΣΗΣ / MOTION DETECTORS**

**ΑΝΙΧΝΕΥΤΗΣ ΚΙΝΗΣΗΣ ΥΠΕΡΥΘΡΩΝ**  
INFRARED MOTION DETECTOR

- Volt 220-240V 50/60Hz • Amperage: 4A
- Detection Angle: 180° • Detection Speed: 0.6-1.5mtr/sec
- Detection Distance: max 12mtr
- Delay Time: min 10sec - max 15min
- Installation Height: 1.8-2.5m



**147-02001**  
White / Λευκό



**147-02000**  
Black / Μαύρο

OP. TEMP.  
-20°C +40°C

IP 44

5  
YEARS  
WARRANTY

INFRARED  
SENSOR

Code	Barcode	Watt	Dimensions(mm)	Color	Weight(kg)	Packing	MOQ
<b>147-02001</b>	5206139220011	max 400W led	80.2x55.5x68.2	WHITE	0.5	1\5\50	3
<b>147-02000</b>	5206139220004	max 400W led	80.2x55.5x68.2	BLACK	0.5	1\5\50	3

**ΑΝΙΧΝΕΥΤΗΣ ΚΙΝΗΣΗΣ ΥΠΕΡΥΘΡΩΝ**  
INFRARED MOTION DETECTOR

- Volt 220-240V 50/60Hz • Amperage: 5.5A
- Detection Angle: 180° • Detection Speed: 0.6-1.5mtr/sec
- Detection Distance: max 12mtr
- Delay Time: min 10sec - max 15min
- Installation Height: 1.8-2.5m



**147-02003**  
White / Λευκό



**147-02005**  
Black / Μαύρο

OP. TEMP.  
-20°C +40°C

IP 65

5  
YEARS  
WARRANTY

INFRARED  
SENSOR

Code	Barcode	Watt	Dimensions(mm)	Color	Weight(kg)	Packing	MOQ
<b>147-02003</b>	5206139038289	max 300W led	119.5x80x51.5	WHITE	0.565	1\5\50	3
<b>147-02005</b>	5207227093326	max 300W led	119.5x80x51.5	BLACK	0.565	1\5\50	3

**ΑΝΙΧΝΕΥΤΗΣ ΚΙΝΗΣΗΣ ΥΠΕΡΥΘΡΩΝ ΟΡΟΦΗΣ**  
CEILING INFRARED MOTION DETECTOR

- Volt 220-240V 50/60Hz • Amperage: 5.5A
- Detection Angle: 180° • Detection Speed: 0.6-1.5mtr/sec
- Detection Distance: max 6mtr • Delay Time: min 10sec - max 7min
- Installation Height: 2.2-4m



OP. TEMP.  
-20°C +40°C

IP 20

5  
YEARS  
WARRANTY

INFRARED  
SENSOR

Code	Barcode	Watt	Dimensions(mm)	Color	Weight(kg)	Packing	MOQ
<b>147-02004</b>	5206139220042	max 300W led	Ø115x58.5	WHITE	0.58	1\5\50	3

**ΑΝΙΧΝΕΥΤΗΣ ΚΙΝΗΣΗΣ ΥΠΕΡΥΘΡΩΝ ΟΡΟΦΗΣ**  
CEILING INFRARED MOTION DETECTOR

- Volt 220-240V 50/60Hz • Amperage: 9A • Detection Angle: 360°
- Detection Speed: 0.6-1.5mtr/sec • Detection Distance: max 6mtr
- Delay Time: min 10sec - max 15min
- Installation Height: 2.2-4m



**147-02009**  
White / Λευκό



**147-02310**  
Black / Μαύρο

OP. TEMP.  
-20°C +40°C

IP 20

5  
YEARS  
WARRANTY

INFRARED  
SENSOR

Code	Barcode	Watt	Dimensions(mm)	Color	Weight(kg)	Packing	MOQ
<b>147-02009</b>	5206139038395	max 1000W led	Ø115x24.3	WHITE	0.501	1\5\50	1
<b>147-02310</b>	5207227498756	max 1000W led	Ø115x24.3	BLACK	0.501	1\5\50	1

**ΑΝΙΧΝΕΥΤΗΣ ΚΙΝΗΣΗΣ ΥΠΕΡΥΘΡΩΝ ΧΩΝΕΥΤΟΣ**  
INFRARED RECESSED MOTION DETECTOR RECESSED

- Volt 220-240V 50/60Hz • Amperage: 5.5A
- Detection Angle: 180° • Detection Speed: 0.6-1.5mtr/sec
- Detection Distance: max 6mtr • Delay Time: min 10sec. max 15min
- Installation Height: 2.2-4m • Cutting Diameter: Ø65mm



OP. TEMP.  
-20°C +40°C

IP 20

5  
YEARS  
WARRANTY

INFRARED  
SENSOR

Code	Barcode	Watt	Dimensions(mm)	Color	Weight(kg)	Packing	MOQ
<b>147-02007</b>	5206139038456	max 300W led	Ø76x75.6	WHITE	0.5	1\50	1

## ΑΝΙΧΝΕΥΤΕΣ ΚΙΝΗΣΗΣ / MOTION DETECTORS

### ΑΝΙΧΝΕΥΤΗΣ ΚΙΝΗΣΗΣ ΥΠΕΡΥΘΡΩΝ ΧΩΝΕΥΤΟΣ INFRARED RECESSED MOTION DETECTOR RECESSED

- Volt 220-240V 50/60Hz • Amperage: 2A
- Detection Angle: 360° • Detection Speed: 0.6-1.5mtr/sec
- Detection Distance: max 6mtr
- Delay Time: min 10sec - max 7min
- Installation Height: 2.2-4m
- Cutting Diameter: Ø20mm



Code	Barcode	Watt	Dimensions(mm)	Color	Weight(kg)	Packing	MOQ
147-02311	5207227438516	max 100W led	22.6x34.2x55.2	WHITE	0.039	1\100	1

### ΑΝΙΧΝΕΥΤΗΣ ΚΙΝΗΣΗΣ ΥΠΕΡΥΘΡΩΝ ΜΙΚΡΩΝ ΑΠΟΣΤΑΣΕΩΝ INFRARED RECESSED MOTION DETECTOR SHORT DISTANCES

- Volt 220-240V 50/60Hz • Amperage: 5A
- Detection Angle: 180° • Detection Speed: 0.6-1.5mtr/sec
- Detection Distance: max 5cm
- Delay Time: min 10sec - max 7min
- Installation Height: 2.2-4m



Code	Barcode	Watt	Dimensions(mm)	Color	Weight(kg)	Packing	MOQ
147-02312	5207227438530	max 200W led	36x18x74.6	WHITE	0.055	1\100	1



**ΑΝΙΧΝΕΥΤΕΣ ΠΑΡΟΥΣΙΑΣ / PRESENCE SENSORS**

**ΑΝΙΧΝΕΥΤΗΣ ΠΑΡΟΥΣΙΑΣ ΥΠΕΡΥΘΡΩΝ ΕΞΩΤΕΡΙΚΟΣ**  
 INFRARED SURFACE PRESENCE SENSOR

- Volt 220-240V 50/60Hz • Amperage: 10A
- Detection Angle: 360° • Detection Speed: 0.6-1.5mtr/sec
- Detection Distance: max: 20mtr
- Delay Time: min 10sec - max 10min
- Installation Height: 2.2-6m
- Ambient Light 10-2000Lux Adjustable

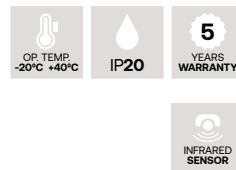

Code	Barcode	Watt	Dimensions(mm)	Color	Weight(kg)	Packing	MOQ
147-02016	5207227058899	max 150W led	Ø120x50	WHITE	0.51	1\50	3

**ΑΝΙΧΝΕΥΤΗΣ ΠΑΡΟΥΣΙΑΣ ΥΠΕΡΥΘΡΩΝ ΕΞΩΤΕΡΙΚΟΣ**  
 INFRARED SURFACE PRESENCE SENSOR

- Volt 220-240V 50/60Hz • Amperage: 5A
- Detection Angle: 360° • Detection Speed: 0.6-1.5mtr/sec
- Detection Distance: min 1m - max 6m
- Delay Time: min 10sec - max 15min
- Installation Height: 2.2-4m
- Ambient Light 10-100Lux Adjustable

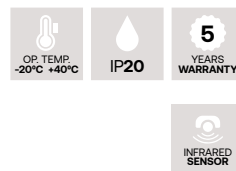

Code	Barcode	Watt	Dimensions(mm)	Color	Weight(kg)	Packing	MOQ
147-02322	5207227438554	max 400W	Ø108x25	WHITE	0.108	1\50	1
147-02323	5207227438578	max 1000W	Ø108x25	WHITE	0.108	1\50	1

**ΑΝΙΧΝΕΥΤΗΣ ΠΑΡΟΥΣΙΑΣ ΥΠΕΡΥΘΡΩΝ ΕΞΩΤΕΡΙΚΟΣ\***  
 INFRARED SURFACE\* PRESENCE SENSOR

- Volt 220-240V 50/60Hz • Amperage: 110A
- Detection Angle: 360° • Detection Speed: 0.6-1.5m/sec
- Detection Distance: min 1m - max 6m
- Delay Time: min 10sec - max 15min
- Installation Height: 2.2-4m
- Ambient Light 10-100Lux Adjustable

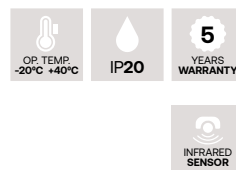

\* ΔΥΝΑΤΟΤΗΤΑ ΧΩΝΕΥΤΟΥ  
 RECESSED FEATURE AVAILABLE

Code	Barcode	Watt	Dimensions(mm)	Color	Weight(kg)	Packing	MOQ
147-02324	5207227438592	max 400W	Ø93x35.5	WHITE	0.118	1\50	1

**ΑΝΙΧΝΕΥΤΗΣ ΠΑΡΟΥΣΙΑΣ ΥΠΕΡΥΘΡΩΝ ΧΩΝΕΥΤΟΣ**  
 INFRARED SURFACE PRESENCE SENSOR RECESSED

- Volt 220-240V 50/60Hz • Amperage: 10A
- Detection Angle: 360° • Detection Speed: 0.6-1.5m/sec
- Detection Distance: min 1m - max 6m
- Delay Time: min 10sec - max 15min
- Installation Height: 2.2-4m • Cut Dimensions: ø90mm
- Ambient Light 10-100Lux Adjustable

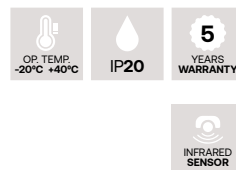

Code	Barcode	Watt	Dimensions(mm)	Color	Weight(kg)	Packing	MOQ
147-02325	5207227438615	max 1000W	Ø93x35.5	WHITE	0.118	1\50	1

## ΑΝΙΧΝΕΥΤΕΣ ΠΑΡΟΥΣΙΑΣ / PRESENCE SENSORS

### ΑΝΙΧΝΕΥΤΗΣ ΠΑΡΟΥΣΙΑΣ ΥΠΕΡΥΘΡΩΝ ΧΩΝΕΥΤΟΣ INFRARED SURFACE PRESENCE SENSOR RECESSED

- Volt 220-240V 50/60Hz • Amperage: 5A
- Detection Angle: 360° • Detection Speed: 0.6-1.5mtr/sec
- Detection Distance: min 1m - max 6m
- Delay Time: min 10sec - max 15min
- Installation Height: 2.2-4m • Cut Dimensions: Ø70mm
- Ambient Light 10-100Lux Adjustable

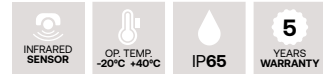

Code	Barcode	Watt	Dimensions(mm)	Color	Weight(kg)	Packing	MOQ
147-02326	5207227438639	max 400W	Ø75x56	WHITE	0.103	1\100	1

### ΑΝΙΧΝΕΥΤΗΣ ΠΑΡΟΥΣΙΑΣ ΕΞΩΤΕΡΙΚΟΣ ΜΕ ΤΕΧΝΟΛΟΓΙΑ ΜΙΚΡΟΚΥΜΑΤΩΝ PRESENCE SENSOR SURFACE WITH MICROWAVE TECHNOLOGY

- Volt 220-240V 50/60Hz • Amperage: 10A
- Detection Angle: 180° • Detection Speed: 0.6-1.5mtr/sec
- Detection Distance: min 2m - max 16m
- Delay Time: min 10sec - max 15min
- Installation Height: 1.8-2.5m
- Ambient Light 10-2000Lux

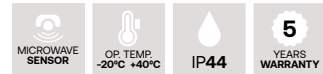

**Προηγμένο επίπεδο ευαισθησίας,**  
εξασφαλίζει  
απαράμιλλη ανταπόκριση και ακρίβεια.

**Advanced level of sensitivity.**  
ensures  
unparalleled responsiveness and accuracy.

Code	Barcode	Watt	Dimensions(mm)	Color	Weight(kg)	Packing	MOQ
147-02327	5207227438653	max 1000W	100x26x70	WHITE	0.192	1\50	1

### ΑΝΙΧΝΕΥΤΗΣ ΠΑΡΟΥΣΙΑΣ ΥΠΕΡΥΘΡΩΝ ΧΩΝΕΥΤΟΣ INFRARED SURFACE PRESENCE SENSOR RECESSED

- Volt 220-240V 50/60Hz • Amperage: 10A
- Detection Angle: 360° • Detection Speed: 0.6-1.5mtr/sec
- Detection Distance 2-6mtr
- Delay Time: min 10sec - max 7min
- Installation Height: 2.2-6m • Cut Dimensions: Ø76mm
- Ambient Light 10-100Lux Adjustable

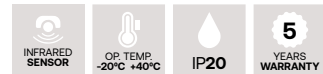

Code	Barcode	Watt	Dimensions(mm)	Color	Weight(kg)	Packing	MOQ
147-02017	5207227058905	max 150W led	Ø110x90	WHITE	0.50	1\50	3



### ΦΩΤΟΚΥΤΤΑΡΟ ΜΕΡΑΣ-ΝΥΧΤΑΣ

PHOTOCELL SWITCH DAY - NIGHT

- Volt 220-240V 50/60Hz
- Amperage: 6A
- Connection Terminal Block

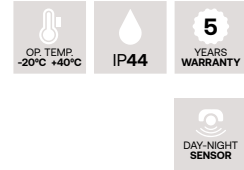

Code	Barcode	Watt	Dimensions(mm)	Color	Weight(kg)	Packing	MOQ
147-02006	5206139038487	max 300W led	44.1x35.5x46	BLUE - WHITE	0.45	1\100	1

### ΦΩΤΟΚΥΤΤΑΡΟ ΜΕΡΑΣ-ΝΥΧΤΑΣ

PHOTOCELL SWITCH DAY - NIGHT

- Volt 220-240V 50/60Hz
- Amperage: 10A
- Connection Terminal Block

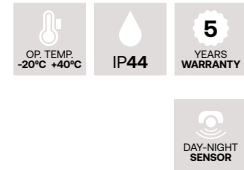

Code	Barcode	Watt	Dimensions(mm)	Color	Weight(kg)	Packing	MOQ
147-02002	5206139220028	max 500W led	Ø63x76.7	WHITE	0.47	1\100	3

### ΦΩΤΟΚΥΤΤΑΡΟ ΜΕΡΑΣ-ΝΥΧΤΑΣ

PHOTOCELL SWITCH DAY - NIGHT

- Volt 220-240V 50/60Hz
- Amperage: 20A
- Connection Terminal Block

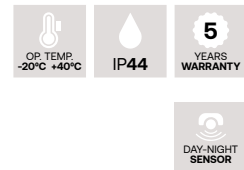

Code	Barcode	Watt	Dimensions(mm)	Color	Weight(kg)	Packing	MOQ
147-02008	5206139038524	max 1000W led	Ø82x108	BLUE - WHITE	0.515	1\50	1

### ΦΩΤΟΚΥΤΤΑΡΟ ΜΕΡΑΣ-ΝΥΧΤΑΣ

PHOTOCELL SWITCH DAY - NIGHT

- Volt 220-240V 50/60Hz
- Amperage: 10A
- Connection Terminal Block

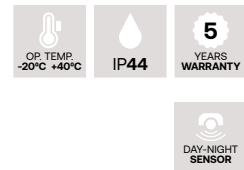

Code	Barcode	Watt	Dimensions(mm)	Color	Weight(kg)	Packing	MOQ
147-02343	5207227438677	max 300W	103x86x79	BLACK - WHITE	0.138	1\50	1

### ΦΩΤΟΚΥΤΤΑΡΑ ΜΕΡΑΣ-ΝΥΧΤΑΣ

PHOTOCELL SWITCHES DAY - NIGHT

- Volt 220-240V 50/60Hz
- Amperage: 10A / 15A / 25A
- Connection Terminal Block

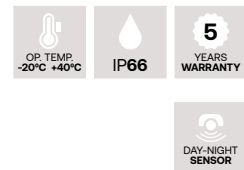

147-02344  
Black / Μαύρο. 10A

147-02345  
Grey / Γκρι. 15A

147-02346  
Blue / Μπλε. 25A

Code	Barcode	Watt	Dimensions(mm)	Color	Weight(kg)	Packing	MOQ
147-02344	5207227438691	max 300W	114x77.5x77.5	BLACK - WHITE	0.113	1\50	1
147-02345	5207227438714	max 400W	114x77.5x77.5	GRAY - WHITE	0.113	1\50	1
147-02346	5207227438738	max 500W	114x77.5x77.5	BLUE - WHITE	0.113	1\50	1

**ΦΩΤΟΚΥΤΤΑΡΟ ΡΑΓΑΣ ΜΕ ΚΑΛΩΔΙΟ  
ΜΕΡΑΣ-ΝΥΧΤΑΣ**  
DIN RAIL PHOTOCELL SWITCH DAY AND NIGHT WITH CABLE

- Volt 220-240V 50/60Hz
- Amperage: 25A
- Connection Terminal Block

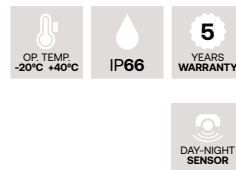

Code	Barcode	Amperage	Dimensions(mm)	Color	Weight(kg)	Packing	MOQ
147-02347	5207227438752	max 500W	90x35x35	GRAY	0.102	1\50	1

**ΦΩΤΟΚΥΤΤΑΡΟ ΧΡΟΝΙΚΟ ΜΕΡΑΣ-ΝΥΧΤΑΣ**  
PHOTOCELL SWITCH DAY AND NIGHT WITH TIMER

- Volt 220-240V 50/60Hz
- Amperage: 15A
- Connection Terminal Block

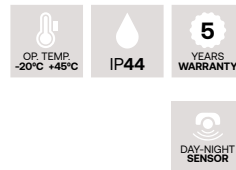

Code	Barcode	Watt	Dimensions(mm)	Color	Weight(kg)	Packing	MOQ
147-02348	5207227438776	max 2000W <small>(1000W energy saving lamp)</small>	100x35x90	WHITE	0.098	1\50	1



### ΑΝΙΧΝΕΥΤΗΣ ΚΑΠΝΟΥ ΑΥΤΟΝΟΜΟΣ AUTONOMOUS SMOKE ALARM

- Current: <25mA • Static Current <10mA
- Alarm Current: <12mA • Working Humidity : <95%
- Low Battery Alarm: 6.2 - 6.8V • Low Voltage Alarm: 5.5-6.2V

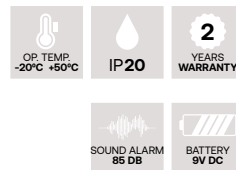

Code	Barcode	Connection	Dimensions(mm)	Color	Weight(kg)	Packing	MOQ
147-02030	5207227058912	TERMINAL BLOCK	Ø132x40.5	WHITE	0.235	1\50	3

### ΑΝΙΧΝΕΥΤΗΣ ΜΟΝΟΞΕΙΔΙΟΥ ΤΟΥ ΑΝΘΡΑΚΑ ΑΥΤΟΝΟΜΟΣ AUTONOMOUS CARBON MONOXIDE DETECTOR

- Static Current <20mA • Alarm Current: <35mA • Working Humidity : 25-85%
- Response Time 50ppm 60-90min. 100ppm 10-40min. ≥300ppm within 3min
- Indicated Operation Light Green Led Flashing every 30sec
- Low Voltage Alarm A "pumping" sound is heard every 30sec
- Indicated Alarm Light Red Led Flashing Rapidly

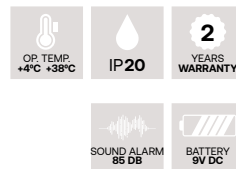

Code	Barcode	Connection	Dimensions(mm)	Color	Weight(kg)	Packing	MOQ
147-02035	5207227106903	TERMINAL BLOCK	Ø102x38	WHITE	0.22	1\50	1

### ΑΣΥΡΜΑΤΟΣ ΑΝΙΧΝΕΥΤΗΣ ΚΑΠΝΟΥ SMART HOME SMART WIRELESS SMOKE DETECTOR HOME

- Volt 9V 6LR61 • Stand by Consumption 0,01mA • Wireless Standard 433,92MHz
- Wireless Accessories Range >100m • Alarm Consumption 35mA
- Υλικό / Material Πλαστικό ABS / Plastic ABS
- Απόσταση Ανίχνευσης / Detection Distance 20m2
- Battery Discharge Time ~12 μήνες / ~12 months

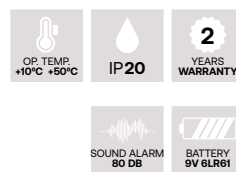

Συνδεσιμότητα Δικτύου  
Network Connectivity  
**RF433 WiFi**

- Περιλαμβάνει / Includes:
- Ανιχνευτής Καπνού / Smoke Sensor • Μπαταρία / Battery
  - Βίδες Στήριξης / Mounting Screws

Code	Barcode	Connection	Dimensions(mm)	Color	Weight(kg)	Packing	MOQ
147-77943	5207227147074	TERMINAL BLOCK	12x11x6	WHITE	0.198	1\10\100	1



**ΚΟΥΔΟΥΝΙ 220-240V**  
DOORBELL 220-240V

- **Connection** Terminal Block



Code	Barcode	Voltage	Sound	Amperage	Dimensions(mm)	Color	Weight(kg)	Packing	MOQ
<b>147-32002</b>	5207227493454	220-240V 50/60Hz	2	110mA	170x105x49	WHITE	0.36	1\12\24	1
<b>147-32001</b>	5207227032127	220-240V 50/60Hz	1	110mA	170x105x49	WHITE	0.36	1\12\24	1

**ΚΟΥΔΟΥΝΙ 12V**  
DOORBELL 12V

- **Connection** Terminal Block

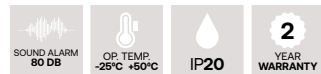

Code	Barcode	Voltage	Sound	Amperage	Dimensions(mm)	Color	Weight(kg)	Packing	MOQ
<b>147-32000</b>	5207227032097	DC12V	1	1250mA	170x105x49	WHITE	0.36	1\12\24	1

**ΚΟΥΔΟΥΝΙ 1 ΗΧΟΥ ΑΣΥΡΜΑΤΟ ΜΠΑΤΑΡΙΑΣ**  
WIRELESS DOORBELL BATTERY OPERATED

- |   |  |
|---|--|
| <p>Bell</p> <ul style="list-style-type: none"> <li>• <b>Volt</b> 3-5V DC. 433.92MHz</li> <li>• <b>Amperage</b> 300mA</li> <li>• <b>Battery</b> 3xAA</li> <li>• <b>Connection</b> Terminal Block</li> <li>• <b>IP20</b></li> </ul> | <p>Button</p> <ul style="list-style-type: none"> <li>• <b>Volt</b> 12V DC. 433.92MHz</li> <li>• <b>Amperage</b> 25mA</li> <li>• <b>Battery</b> 1x23A 12V</li> <li>• <b>Connection</b> Terminal Block</li> <li>• <b>IP44</b></li> </ul> |
|---|--|

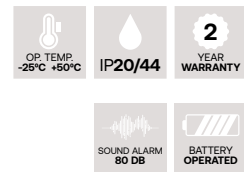

Code	Barcode	Dimensions BELL / BUTON (mm)	Color	Weight(kg)	Packing	MOQ
<b>147-32020</b>	5207227032158	155xx109x46 / 86x39x19	WHITE - SILVER	0.36	1\10\40	1

**ΚΟΥΔΟΥΝΙ 1 ΗΧΟΥ ΑΣΥΡΜΑΤΟ ΠΡΙΖΑΣ**  
WIRELESS DOORBELL PLUGED INTO SOCKET

- |  |  |
|--|--|
| <p>Bell</p> <ul style="list-style-type: none"> <li>• <b>Volt</b> 220-240V. 433.92MHz</li> <li>• <b>Amperage</b> 70mA</li> <li>• <b>Connection</b> Terminal Block</li> <li>• <b>IP20</b></li> </ul> | <p>Button</p> <ul style="list-style-type: none"> <li>• <b>Volt</b> 3.3V DC. 433.92MHz</li> <li>• <b>Amperage</b> 25mA</li> <li>• <b>Battery</b> 1xCR2032</li> <li>• <b>Connection</b> Terminal Block</li> <li>• <b>IP44</b></li> </ul> |
|--|--|

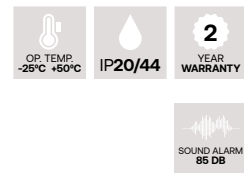

Code	Barcode	Dimensions BELL / BUTON (mm)	Color	Weight(kg)	Packing	MOQ
<b>147-32021</b>	5207227032165	49x60x98 / 23x32x82	WHITE	0.1	1\25\50	1



## ΧΡΟΝΟΔΙΑΚΟΠΤΗΣ ΕΞΩΤΕΡΙΚΟΣ TIMER SWITCH SURFACE WALL MOUNTED

- Production Material Plastic & ABS
- Voltage: 100-240V 50/60Hz
- Amperage: 16A
- 24 ώρες Δυνατότητα Ρύθμισης / 24 hours Adjustable Time
- 150 ώρες Αυτονομία / 150 hours Discharge Time



Code	Barcode	Watt	Dimensions(mm)	Packing	MOQ
147-35012	5207227013331	max 150W	112x83.5x51.5	1/50	1

## ΧΡΟΝΟΔΙΑΚΟΠΤΗΣ ΠΡΙΖΑΣ 24 ΩΡΩΝ TIMER SWITCH 24 HOURS

- Production Material PC
- Voltage: 100-240V 50/60Hz
- Amperage: 16A
- 24 ώρες Δυνατότητα Ρύθμισης / 24 hours Adjustable Time
- Αλλαγή ρύθμισης μετά την πάροδο 30 min από την προηγούμενη Adjustment change after 30 min from previous



Code	Barcode	Watt	Dimensions(mm)	Packing	MOQ
147-35000	5206139230003	3680W	54x103x70	1\20\60	10

## ΧΡΟΝΟΔΙΑΚΟΠΤΗΣ ΠΡΙΖΑΣ 24 ΩΡΩΝ TIMER SWITCH 24 HOURS

- Production Material PC
- Voltage: 100-240V 50/60Hz
- Amperage: 16A
- 24 ώρες Δυνατότητα Ρύθμισης / 24 hours Adjustable Time
- Αλλαγή ρύθμισης μετά την πάροδο 30 min από την προηγούμενη Adjustment change after 30 min from previous



Code	Barcode	Watt	Dimensions(mm)	Packing	MOQ
147-35001	5207227099311	3680W	55x120x83	1/10/40	5



**ΘΕΡΜΟΣΤΑΤΗΣ ΘΕΡΜΟΣΙΦΩΝΟΥ**  
WATER HEATER THERMOSTAT

- **Volt:** 220-240. 50/60Hz. • **Amperage:** 1A
- **Range of temperature adjustment:** 30-80°C



Code	Barcode	Contact	Color	Dimensions(mm)	Weight(kg)	Packing	MOQ
147-44500	5207227059902	NO/NC	BLUE	50x30x40	0.102	1\100	1

**ΘΕΡΜΟΣΤΑΤΗΣ ΘΕΡΜΟΣΙΦΩΝΟΥ**  
WATER HEATER THERMOSTAT

- **Volt:** 220-240. 50/60Hz. • **Amperage:** 1A
- **Range of temperature adjustment:** 30-80°C



Code	Barcode	Contact	Color	Dimensions(mm)	Weight(kg)	Packing	MOQ
147-44501	5207227059926	2NO+2NC	BLUE	50x30x40	0.110	1\100	1

**ΘΕΡΜΟΣΤΑΤΗΣ ΘΕΡΜΟΣΙΦΩΝΟΥ**  
**ΚΟΥΜΠΩΤΟΣ**  
WATER HEATER THERMOSTAT BUTTONED

- **Volt:** 220-240. 50/60Hz
- **Range of temperature adjustment:** 18-70°C



Code	Barcode	Contact	Color	Dimensions(mm)	Weight(kg)	Packing	MOQ
147-44502	5207227059940	NO/NC	WHITE	Ø50x28	0.094	1\100	1

**ΜΗΧΑΝΙΚΟΣ**  
**ΘΕΡΜΟΣΤΑΤΗΣ ΧΩΡΟΥ**  
MECHANICAL ROOM THERMOSTAT

**ΕΞΩΤΕΡΙΚΟΣ / WALL-MOUNTED**

- **Volt:** 220-250. 50/60Hz. • **Amperage:** 3A
- **Range of temperature adjustment:** 0-40°C
- **Installation:** Surface-mounted type (On the wall)



Code	Barcode	Watt	Contact	Color	Dimensions(mm)	Weight(kg)	Packing	MOQ
147-44002	5207227147500	2kW	NO/NC	WHITE	84x84x39	0.080	1\100	1

**ΕΒΔΟΜΑΔΙΑΙΟΣ ΨΗΦΙΑΚΟΣ ΘΕΡΜΟΣΤΑΤΗΣ ΧΩΡΟΥ**  
WEEKLY DIGITAL ROOM THERMOSTAT

**ΕΞΩΤΕΡΙΚΟΣ / WALL-MOUNTED**

- **Volt:** 220. 50/60Hz. • **Amperage:** 0.5A
- **Range of temperature adjustment:** 5-35°C
- **Running program:** Set per 1 week as a cycle
- **Installation:** Surface-mounted type (On the wall)

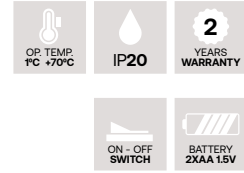

Code	Barcode	Watt	Contact	Color	Dimensions(mm)	Weight(kg)	Packing	MOQ
147-44012	5207227147999	100W	Dry Contact	WHITE	73x35x25	0.190	1\100	1

**ΕΒΔΟΜΑΔΙΑΙΟΣ ΨΗΦΙΑΚΟΣ ΘΕΡΜΟΣΤΑΤΗΣ ΧΩΡΟΥ**  
WEEKLY DIGITAL ROOM THERMOSTAT

**ΕΞΩΤΕΡΙΚΟΣ / WALL-MOUNTED**

- **Volt:** 220. 50/60Hz. • **Amperage:** 0.5A
- **Range of temperature adjustment:** 5-35°C
- **Running program:** Set per 1 week as a cycle
- **Installation:** Surface-mounted type (On the wall)

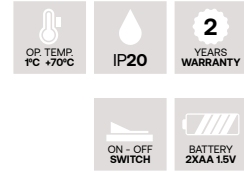

Code	Barcode	Watt	Contact	Color	Dimensions(mm)	Weight(kg)	Packing	MOQ
147-44013	5207227148002	100W	Dry Contact	WHITE	86x86x27	0.190	1\100	1

**ΕΒΔΟΜΑΔΙΑΙΟΣ ΨΗΦΙΑΚΟΣ ΘΕΡΜΟΣΤΑΤΗΣ ΧΩΡΟΥ**  
WEEKLY DIGITAL ROOM THERMOSTAT

**ΕΞΩΤΕΡΙΚΟΣ / WALL-MOUNTED**

- **Power:** Alkaline batteries 2xAA / 1.5V
- **Range of temperature adjustment:** 5 ~ 35°C
- **Running program:** Set per 1 week as a cycle
- **Installation:** Wall mounted or on battery seat

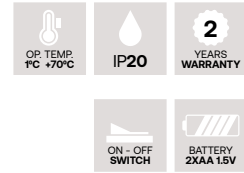

Code	Barcode	Watt	Contact	Color	Dimensions(mm)	Weight(kg)	Packing	MOQ
147-44014	5207227148019	100W	Dry Contact	WHITE	86x86x27	0.190	1\100	1

**ΕΒΔΟΜΑΔΙΑΙΟΣ ΨΗΦΙΑΚΟΣ ΘΕΡΜΟΣΤΑΤΗΣ ΧΩΡΟΥ**  
WEEKLY DIGITAL ROOM THERMOSTAT

**ΧΩΝΕΥΤΟΣ / RECESSED**

- **Volt:** 90-220V 50/60Hz • **Amperage:** 3A
- **Range of temperature adjustment:** 5-35°C
- **Running program:** Set per 1 week as a cycle
- **Installation:** Recessed type (in the wall)

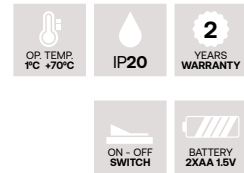

Code	Barcode	Watt	Contact	Color	Dimensions(mm)	Weight(kg)	Packing	MOQ
147-44040	5207227148033	200W	NO or NC	WHITE	86x86x27	0.240	1\100	1

**ΕΒΔΟΜΑΔΙΑΙΟΣ ΑΣΥΡΜΑΤΟΣ ΨΗΦΙΑΚΟΣ ΘΕΡΜΟΣΤΑΤΗΣ ΧΩΡΟΥ**  
WIRELESS WEEKLY DIGITAL ROOM THERMOSTAT

**ΧΩΝΕΥΤΟΣ / RECESSED**

- **Volt:** 90-240V 50/60Hz • **Amperage:** 5A
- **Range of temperature adjustment:** 5-35°C
- **Running program:** Set per 1 week as a cycle
- **Installation:** Recessed type (in the wall)



ΕΠΙΤΟΙΧΙΟ ΜΕΡΟΣ  
wall mounted part



ΑΠΟΣΠΩΜΕΝΟ ΜΕΡΟΣ  
detachable part



Code	Barcode	Watt	Contact	Color	Dimensions(mm)	Weight(kg)	Packing	MOQ
147-44050	5207227412929	1760W	Dry Contact	WHITE	86x86x30	0.210	1\100	1

**ΕΒΔΟΜΑΔΙΑΙΟΣ  
ΨΗΦΙΑΚΟΣ ΘΕΡΜΟΣΤΑΤΗΣ ΧΩΡΟΥ**  
WEEKLY DIGITAL ROOM THERMOSTAT

**ΕΞΩΤΕΡΙΚΟΣ / WALL-MOUNTED**

- **Volt:** 220, 50/60Hz. • **Amperage:** 1A
- **Range of temperature adjustment:** 5-35°C
- **Running program:** Set per 1 week as a cycle
- **Installation:** Surface-mounted type (On the wall)

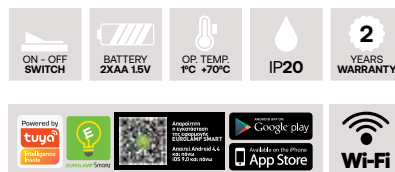

Code	Barcode	Watt	Contact	Color	Dimensions(mm)	Weight(kg)	Packing	MOQ
147-44041	5207227148040	2000W	Dry Contact	WHITE	130x90x25	0.190	1\100	1

**ΕΒΔΟΜΑΔΙΑΙΟΣ  
ΨΗΦΙΑΚΟΣ ΘΕΡΜΟΣΤΑΤΗΣ ΧΩΡΟΥ**  
WEEKLY DIGITAL ROOM THERMOSTAT

**ΧΩΝΕΥΤΟΣ / RECESSED**

- **Volt:** 220, 50/60Hz. • **Amperage:** 1A
- **Range of temperature adjustment:** 5-35°C
- **Running program:** Set per 1 week as a cycle
- **Installation:** Surface-mounted type (On the wall)
- **Λειτουργία boiler / Boiler function**

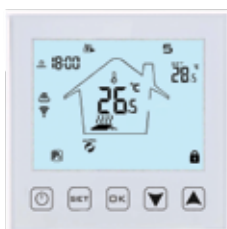

Code	Barcode	Watt	Contact	Color	Dimensions(mm)	Weight(kg)	Packing	MOQ
147-44030	5207227148026	2000W	NO or NC	WHITE	86x86x27	0.240	1\100	1

**ΕΒΔΟΜΑΔΙΑΙΟΣ  
ΨΗΦΙΑΚΟΣ ΘΕΡΜΟΣΤΑΤΗΣ ΧΩΡΟΥ**  
WEEKLY DIGITAL ROOM THERMOSTAT

**ΧΩΝΕΥΤΟΣ / RECESSED**

- **Volt:** 90-240, 50/60Hz. • **Amperage:** 3A
- **Range of temperature adjustment:** 5-35°C
- **Running program:** Set per 1 week as a cycle
- **Installation:** Surface-mounted type (On the wall)
- **Λειτουργία boiler / Boiler function**

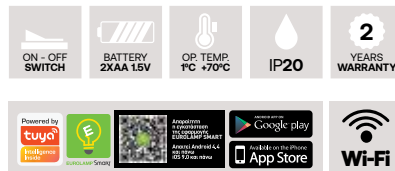

Code	Barcode	Watt	Contact	Color	Dimensions(mm)	Weight(kg)	Packing	MOQ
147-44035	5207227412882	500W	Dry Contact	BLACK	86x86x27	0.190	1\100	1

**ΕΒΔΟΜΑΔΙΑΙΟΣ  
ΨΗΦΙΑΚΟΣ ΘΕΡΜΟΣΤΑΤΗΣ ΧΩΡΟΥ**  
WEEKLY DIGITAL ROOM THERMOSTAT

**ΕΞΩΤΕΡΙΚΟΣ / WALL-MOUNTED**

- **Volt:** 90-240, 50/60Hz. • **Amperage:** 5A
- **Range of temperature adjustment:** 5-35°C
- **Running program:** Set per 1 week as a cycle
- **Installation:** Surface-mounted type (On the wall)

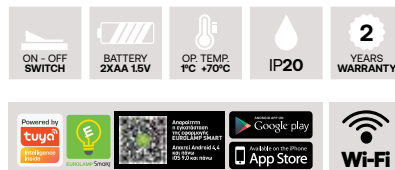

Code	Barcode	Watt	Contact	Color	Dimensions(mm)	Weight(kg)	Packing	MOQ
147-44045	5207227412905	1760W	Dry Contact	BLACK	130x90x29	0.190	1\100	1

**ΗΧΕΙΟ ΟΡΟΦΗΣ**  
CEILING AUDIO SPEAKER

- **Volt:** 100V, 90-18khz
- **Production Material:** Αλουμίνιου-Πλαστικό / Aluminium-Plastic
- **Watt:** 10W



OP. TEMP. -10°C +60°C	CUT. DIMENSIONS Ø205mm	IP20	2 YEAR WARRANTY
SOUND VOLUME 91 DB			

Code	Barcode	Contact	Color	Dimensions(mm)	Weight(kg)	Packing	MOQ
147-68973	5207227032189	NO/NC	WHITE	Ø240 x 80	1.63	1\20	1



**ΕΞΟΠΛΙΣΜΟΣ ΜΠΑΝΙΟΥ  
ΞΕΝΟΔΟΧΕΙΩΝ & ΕΠΙΧΕΙΡΗΣΕΩΝ  
BATH EQUIPMENT  
FOR HOTELS & BUSINESSES**

**ΕΞΑΕΡΙΣΤΗΡΕΣ ΜΠΑΝΙΟΥ  
BATH VENTILATION**

**ΣΕΣΟΥΑΡ ΞΕΝΟΔΟΧΕΙΟΥ  
HAIR DRYER FOR HOTELS**

**ΣΤΕΓΝΩΤΗΡΕΣ ΧΕΡΙΩΝ  
HAND DRYERS**



### ΕΞΑΕΡΙΣΤΗΡΑΣ ΜΠΑΝΙΟΥ BATH VENTILATION FAN

- Volt: 220-240, 50/60Hz
- Amperage: 0.054A

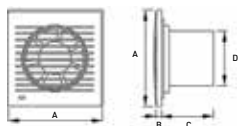

Code	Barcode	Watt	Air Flow (m <sup>3</sup> /h)	Color	Dimensions A/B/C/D(mm)	Weight(kg)	Packing	MOQ
147-33210	5207227014123	15W	100	WHITE	158 / 22 / 60 / Ø100	0.536	1/30	1
147-33211	5207227014130	20W	150	WHITE	175 / 22 / 61 / Ø120	0.583	1/24	1

### ΕΞΑΕΡΙΣΤΗΡΑΣ ΜΠΑΝΙΟΥ BATH VENTILATION FAN

- Volt: 220-240, 50/60Hz
- Amperage: 0.054A
- Damper NON-Return Air

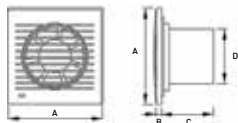

147-33240/41



147-33243

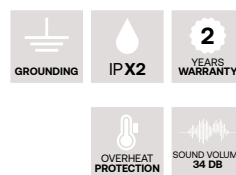

Code	Barcode	Watt	Air Flow (m <sup>3</sup> /h)	Color	Dimensions A/B/C/D(mm)	Weight(kg)	Packing	MOQ
147-33240	5207227069314	12W	130	WHITE	157 / 21 / 60 / Ø100	0.698	1/20	1
147-33241	5207227069338	16W	140	WHITE	157 / 21 / 65 / Ø120	0.637	1/20	1
147-33243	5207227288630	12W	130	NICKEL MAT	157 / 21 / 60 / Ø100	0.698	1/20	1

### ΕΞΑΕΡΙΣΤΗΡΑΣ ΜΠΑΝΙΟΥ ME XPOHODIAKOΠHTH BATH VENTILATION FAN WITH TIMER

- Volt: 220-240, 50/60Hz
- Amperage: 0.054A
- Damper NON-Return Air

The timer ensures the ventilator operation after the switch is closed & it is adjusted from 30sec - 30min

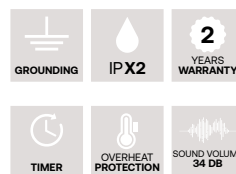
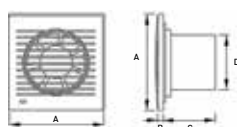

Code	Barcode	Watt	Air Flow (m <sup>3</sup> /h)	Color	Dimensions A/B/C/D(mm)	Weight(kg)	Packing	MOQ
147-33242	5207227069352	12W	130	WHITE	157 / 21 / 65 / Ø100	0.698	1/20	1

### ΕΞΑΕΡΙΣΤΗΡΑΣ ΜΠΑΝΙΟΥ ME XPOHODIAKOΠHTH BATH VENTILATION FAN WITH TIMER

- Volt: 220-240, 50/60Hz
- Amperage: 0.054A
- Damper NON-Return Air

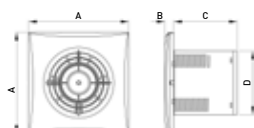

ULTRA THIN FRAME  
ΛΕΠΤΗ ΠΡΟΣΩΨΗ



Code	Barcode	Watt	Air Flow (m <sup>3</sup> /h)	Color	Dimensions A/B/C/D(mm)	Weight(kg)	Packing	MOQ
147-33220	5207227069277	12W	140	WHITE	150 / 13 / 90 / Ø100	0.642	1/20	1

**ΕΞΑΕΡΙΣΤΗΡΑΣ ΜΠΑΝΙΟΥ**  
BATH VENTILATION FAN

- **Volt:** 220-240, 50/60Hz
- **Amperage:** 0.054A
- **Damper NON-Return Air**



Code	Barcode	Watt	Air Flow (m <sup>3</sup> /h)	Color	Dimensions A/B/C/D(mm)	Weight(kg)	Packing	MOQ
147-33230	5207227069291	12W	93	WHITE	150 / 35 / 90 / Ø100	0.696	1/24	1

**ΕΞΑΕΡΙΣΤΗΡΑΣ ΜΠΑΝΙΟΥ**  
BATH VENTILATION FAN

- **Volt:** 220-240, 50/60Hz
- **Amperage:** 0.054A
- **Damper NON-Return Air**



Code	Barcode	Watt	Air Flow (m <sup>3</sup> /h)	Color	Dimensions A/B/C/D(mm)	Weight(kg)	Packing	MOQ
147-33231	5207227288593	12W	95	BLACK	151 / 35 / 102 / Ø100	0.750	1/20	1

**ΕΞΑΕΡΙΣΤΗΡΑΣ ΜΠΑΝΙΟΥ**  
BATH VENTILATION FAN

- **Volt:** 220-240, 50/60Hz
- **Amperage:** 0.054A
- **Damper NON-Return Air**



Code	Barcode	Watt	Air Flow (m <sup>3</sup> /h)	Color	Dimensions A/B/C/D(mm)	Weight(kg)	Packing	MOQ
147-33232	5207227288616	12W	95	BLACK	160 / 32 / 89 / Ø99	0.666	1/27	1

**ΕΞΑΕΡΙΣΤΗΡΑΣ ΜΠΑΝΙΟΥ**  
BATH VENTILATION FAN

- **Volt:** 220-240, 50/60Hz
- **Amperage:** 0.054A
- **Damper NON-Return Air**



Code	Barcode	Watt	Air Flow (m <sup>3</sup> /h)	Color	Dimensions A/B/C(mm)	Weight(kg)	Packing	MOQ
147-33250	5207227069376	12W	140	WHITE	100 / 98 / Ø89.5	0.698	1/20	1

## ΣΕΣΟΥΑΡ ΞΕΝΟΔΟΧΕΙΟΥ HOTEL HAIR DRYER

### UK TYPE & SCHUKO PLUG

- **Volt:** 220-240, 50/60Hz, • **Amperage:** 5.5A
- **Air Speed** 13m/sec
- **Cable Length** 300mm
- **Air Temperature** 50°C - 65°C



Code	Barcode	Watt	Cord Ext.(mm)	Color	Dimensions(mm)	Weight(kg)	Packing	MOQ
147-45001	5207227069413	1200W	800	WHITE	230x185x95	0.806	1/12	1

## ΣΕΣΟΥΑΡ ΞΕΝΟΔΟΧΕΙΟΥ HOTEL HAIR DRYER

### UK HOLE & SCHUKO PLUG

- **Volt:** 220-240, 50/60Hz, • **Amperage:** 7.25A
- **Air Speed** 18m/sec
- **Cable Length** 300mm
- **Air Temperature** 50°C - 65°C



147-45010  
White/Λευκό

147-45012  
Black/Μαύρο



Code	Barcode	Watt	Cord Ext.(mm)	Color	Dimensions(mm)	Weight(kg)	Packing	MOQ
147-45010	5207227069390	1500W	800	WHITE	260x250x140	0.922	1/12	1
147-45011	5207227257667	1500W	800	BLACK	260x250x140	0.922	1/12	1

## ΣΤΕΓΝΩΤΗΡΑΣ ΧΕΡΙΩΝ ΠΛΑΣΤΙΚΟΣ ΜΕ ΧΡΟΝΟΔΙΑΚΟΠΤΗ PLASTIC HAND DRYER WITH TIMER

147-45100

- **Volt:** 220-240, 50/60Hz
- **Amperage:** 8.20A
- **Air Speed** 20m/sec
- **Detection Distance** 0.5m
- **Delay Time** 1sec
- **Air Temp.** 40°C - 55°C

147-45101

- **Volt:** 220-240, 50/60Hz
- **Amperage:** 8.18A
- **Air Speed** 16m/sec
- **Detection Distance** 0.5m
- **Delay Time** 1sec
- **Air Temp.** 40°C - 55°C



147-45100  
White/Λευκό

147-45101  
Black/Μαύρο



Code	Barcode	Watt	Color	Dimensions(mm)	Weight(kg)	Packing	MOQ
147-45100	5207227069437	1800W	WHITE	240x240x230	2.159	1/8	1
147-45101	5207227288654	1800W	BLACK	240x240x230	2.750	1/8	1





## ΕΡΓΑΛΕΙΑ TOOLS

ΤΑΙΝΙΕΣ ΜΟΝΩΤΙΚΕΣ & ΣΥΣΚΕΥΑΣΙΑΣ  
INSULATING & PACKAGING TAPES

ΚΑΤΣΑΒΙΔΙΑ  
TEST SCREWDRIVERS

ΚΟΦΤΑΚΙΑ  
DIAGONAL CUTTING NIPPERS

ΠΕΝΣΑ  
COMBINATION PLIER

ΜΙΤΟΤΣΙΜΠΙΔΟ  
SNIPE NOSE PLIERS

ΚΟΠΙΔΙ  
UTILITY CUTTER

ΨΗΦΙΑΚΟ ΠΟΛΥΜΕΤΡΟ  
DIGITAL MULTIMETER

ΨΗΦΙΑΚΗ ΑΜΠΕΡΟΤΣΙΜΠΙΔΑ  
DIGITAL CLAMP METER

**ΜΟΝΩΤΙΚΕΣ ΤΑΙΝΙΕΣ**  
PVC ELECTRICAL INSULATING TAPES  
**FLAME RETARDANT MATERIAL**



Code	Barcode	Color	Length(m)	Width(mm)	Thickness(mm)	Packing	MOQ
147-34000	5206139202000	WHITE	20	19	0.125	1\10\300	10
147-34001	5206139202017	BLACK	20	19	0.125	1\10\300	10
147-34002	5206139202024	RED	20	19	0.125	1\10\300	10
147-34003	5206139202031	YELLOW	20	19	0.125	1\10\300	10
147-34004	5206139202048	YELLOW-GREEN	20	19	0.125	1\10\300	10
147-34005	5206139202055	GREEN	20	19	0.125	1\10\300	10
147-34006	5206139202062	BLUE	20	19	0.125	1\10\300	10
147-34007	5206139202079	GREY	20	19	0.125	1\10\300	10
147-34008	5206139202086	BROWN	20	19	0.125	1\10\300	10

**38mm • 20 m**



Code	Barcode	Color	Length(m)	Width(mm)	Thickness(mm)	Packing	MOQ
147-34010	5206139202109	WHITE	20	38	0.125	1\5\150	10
147-34011	5206139202116	BLACK	20	38	0.125	1\5\150	10

**48mm • 20 m**



Code	Barcode	Color	Length(m)	Width(mm)	Thickness(mm)	Packing	MOQ
147-34032	5207227261749	WHITE	20	48	0.125	1\5\150	10
147-34033	5207227261770	BLACK	20	48	0.125	1\5\150	10

**ΜΟΝΩΤΙΚΕΣ ΤΑΙΝΙΕΣ ΑΥΤΟΒΟΥΛΚΑΝΙΖΟΜΕΝΕΣ**  
PVC SELF VULCANIZING RUBBER TAPES

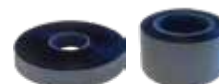

Code	Barcode	Color	Length(m)	Width(mm)	Thickness(mm)	Packing	MOQ
147-34020	5206139072948	BLACK	9	19	0.90	1\48	5
147-34021	5206139072986	BLACK	1.5	38	0.90	1\48	5

**ΤΑΙΝΙΑ ΣΥΣΚΕΥΑΣΙΑΣ "FRAGILE"**  
FRAGILE PACKAGING TAPE FRAGILE



Code	Barcode	Color	Length(m)	Width(mm)	Packing	MOQ
147-34050	5206139068316	WHITE WITH RED TYPE 'FRAGILE'	60	48	6\54	6

### ΚΑΤΣΑΒΙΔΙ ΔΟΚΙΜΑΣΤΙΚΟ

SCREWDRIVER WITH TESTER

- Voltage 100-500V 50/0Hz
- Production Material AS



Code	Barcode	Size	Dimensions(mm)	Weight(kg)	Packing	MOQ
147-18000	5206139211002	SMALL	140x3	0.047	1\20\50	20
147-18001	5206139211019	BIG	200x3.5	0.054	1\20\50	20

### ΣΕΤ ΚΑΤΣΑΒΙΔΙ ΔΟΚΙΜΑΣΤΙΚΟ

SET SCREWDRIVER WITH TESTER

- Voltage 100-500V 50/0Hz
- Production Material AS



Code	Barcode	Size	Dimensions(mm)	Weight(kg)	Packing	MOQ
147-18020	5207227029714	SMALL	140x3	0.014	1\20\600	20
147-18021	5207227029745	BIG	185x3.5	0.026	1\20\600	20

### ΣΕΤ ΠΟΛΥΧΡΩΜΟ ΚΑΤΣΑΒΙΔΙ ΔΟΚΙΜΑΣΤΙΚΟ

SET MULTICOLOR SCREWDRIVER WITH TESTER

- Voltage 100-500V 50/0Hz
- Production Material AS



Code	Barcode	Size	Dimensions(mm)	Weight(kg)	Packing	MOQ
147-18022	5207227147364	SMALL	140x3	0.015	1\20\600	20
147-18023	5207227147395	BIG	190x4	0.029	1\20\600	20

## ΨΗΦΙΑΚΟ ΠΟΛΥΜΕΤΡΟ

DIGITAL MULTIMETER

- Production Material PLASTIC & METALLIC
- Cable Length: 300mm
- Measurement Range DC Volt: 2V-20V-200V-500V
- Measurement Range AC Volt: 200V-500V
- Measurement Range DC A: 5A
- Resistance: 200-2K-20K-200K-2M & Omega

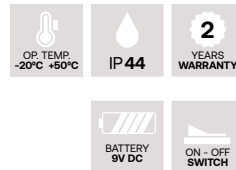

Code	Barcode	Display	Dimensions(mm)	Weight(kg)	Packing	MOQ
147-18500	5207227059186	Digital Monitor	135x67x33	0.34	1\50	1

## ΨΗΦΙΑΚΟ ΠΟΛΥΜΕΤΡΟ ΤΣΕΠΗΣ

POCKET DIGITAL MULTIMETER

- Production Material PLASTIC & METALLIC
- Cable Length: 200mm
- Measurement Range DC Volt: 2V-200V-400V
- Measurement Range AC Volt: 200V-400V
- Measurement Range DC A: 200mA
- Resistance: 200-2K-20K-200-200K- Omega

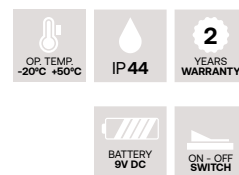

Code	Barcode	Display	Dimensions(mm)	Weight(kg)	Packing	MOQ
147-18501	5207227059209	Digital Monitor	102x60x24	0.12	1\50\100	1

## ΨΗΦΙΑΚΗ ΑΜΠΕΡΟΤΣΙΜΠΙΔΑ

DIGITAL CLAMP METER

- Production Material PLASTIC & METALLIC
- Cable Length: 300mm
- Measurement Range DC Volt: 1000V
- Measurement Range AC Volt: 750V
- Measurement Range DC A: 200-1000A
- Resistance: 200-20K- Omega

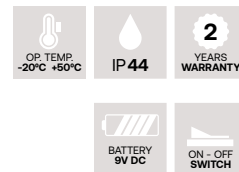

Code	Barcode	Display	Dimensions(mm)	Weight(kg)	Packing	MOQ
147-18502	5207227059223	Digital Monitor	230x68x37	0.34	1\40	1



**ΑΝΑΛΩΣΙΜΟ  
ΗΛΕΚΤΡΟΛΟΓΙΚΟ ΥΛΙΚΟ  
ELECTRICAL CONSUMABLES**

**ΚΛΕΜΜΕΣ  
TERMINAL BLOCKS**

**ΚΥΠΑΡΙΣΣΑΚΙ  
CONNECTION TERMINALS T8 SUPLEX**

**ΜΠΑΡΕΣ ΟΥΔΕΤΕΡΟΥ  
DIN RAIL NEUTRAL CONNECTOR**

**ΜΠΛΟΚ ΔΙΑΝΟΜΗΣ ΡΑΓΑΣ  
DIN RAIL DISTRIBUTION BLOCK BAR**

**ΔΙΑΚΛΑΔΩΤΗΣ ΡΑΓΑΣ  
DIN RAIL SPLITTER**

**ΚΑΨΕΣ ΚΑΛΩΔΙΩΝ  
WIRE CONNECTORS**

**ΟΥΠΑ  
EXPAND PLUG**

**ΣΥΝΔΕΣΜΟΣ ΚΑΛΩΔΙΩΝ  
WIRE CONNECTOR**

**ΑΝΤΑΠΤΟΡ SOLAR  
SOLAR ADAPTERS**

**ΔΕΜΑΤΙΚΑ  
CABLE TIES**

**ΡΟΚΑ  
CABLE CLIPS**

## ΣΤΑΝΤ ΓΙΑ ΚΛΕΜΜΕΣ STAND FOR TERMINAL BLOCKS



• **Code Stand:**  
147-99860

• **For this stand you must select the following codes:**  
147-11040 / 147-11041 / 147-11042 / 147-11049  
147-11060 / 147-11061 / 147-11062 / 147-11050  
147-11043 / 147-11044 / 147-11045 / 147-11069  
147-11046 / 147-11047 / 147-11048  
147-11070 / 147-11071 / 147-11072 / 147-11068  
147-11063 / 147-11064 / 147-11065 / 147-11074  
147-11066 / 147-11067 / 147-11073

• **Minimum order required for free stand disposal:**  
5 pcs of each code

### ΚΛΕΜΜΑ TERMINAL BLOCKS

- Production Material PC
- Amperage 32A



Code	Barcode	Color	Seats	Size(mm)	Dimensions(mm)	Packing	MOQ
147-11040	5207227099373	CLEAR & ORANGE	2	0.20-4mm	19.4x13x9.6	25\250\3000	25
147-11041	5207227099380	CLEAR & ORANGE	3	0.20-4mm	19.4x18.6x9.6	25\250\3000	25
147-11042	5207227099397	CLEAR & ORANGE	5	0.20-4mm	19.4x29.8x9.6	25\250\2500	25

### ΚΛΕΜΜΑ TERMINAL BLOCKS

- Production Material PC
- Amperage 32A



Code	Barcode	Color	Seats	Size(mm)	Dimensions(mm)	Packing	MOQ
147-11060	5207227260681	CLEAR & BLUE	2	0.20-4mm	19.2x15.5x10.5	25/250/2000	25
147-11061	5207227260728	CLEAR & BLUE	3	0.20-4mm	19.2x21.8x10.8	25/250/2000	25
147-11062	5207227260766	CLEAR & BLUE	5	0.20-4mm	19.2x34.4x10.8	25/250/2000	25

### ΚΛΕΜΜΑ TERMINAL BLOCKS

- Production Material PC
- Amperage 32A



Code	Barcode	Color	Seats	Size(mm)	Dimensions(mm)	Packing	MOQ
147-11043	5207227099403	CLEAR & WHITE	2	0.50-2.5	16.3x9.9x5.7	25\250\5000	25
147-11044	5207227099410	CLEAR & ORANGE	3	0.50-2.5	16.3x13.9x5.7	25\250\5000	25
147-11045	5207227099427	CLEAR & RED	4	0.50-2.5	16.3x17.9x5.7	25\250\5000	25
147-11046	5207227099434	CLEAR & YELLOW	5	0.50-2.5	16.3x21.9x5.7	25\250\5000	25
147-11047	5207227099441	CLEAR & WHITE	8	0.50-2.5	16.3x17.8x11.3	20\200\5000	25

### ΚΛΕΜΜΑ TERMINAL BLOCKS

- Production Material PC
- Amperage 32A



Code	Barcode	Color	Seats	Size(mm)	Dimensions(mm)	Packing	MOQ
147-11048	5207227099458	GREY & ORANGE	2	0.80-2.5	21.2x12.5x14.5	25\250\3000	25
147-11049	5207227099465	GREY & ORANGE	3	0.80-2.5	21.2x17.1x14.5	25\250\3000	25
147-11050	5207227099472	GREY & ORANGE	5	0.80-2.5	21.2x26.4x14.5	20\200\3000	20

### ΚΛΕΜΜΑ ΣΥΝΔΕΣΜΟΣ TERMINAL CONNECTOR

- Production Material PC
- Amperage 32A



Code	Barcode	Color	Seats	Size(mm)	Dimensions(mm)	Packing	MOQ
147-11070	5207227261107	GREY / ORANGE	2	0.20-2.5	41.5x13.5x14.8	25/250/2000	25
147-11071	5207227261145	GREY / ORANGE	3	0.20-2.5	41.5x18.5x14.8	25/250/2000	25
147-11072	5207227261183	GREY / ORANGE	4	0.20-2.5	41.5x23.5x14.8	10/100/800	10

### ΚΛΕΜΜΑ ΚΛΕΦΤΗΣ TERMINAL BLOCK

- Production Material PC
- Amperage 32A



Code	Barcode	Color	Seats	Size(mm)	Dimensions(mm)	Packing	MOQ
147-11073	5207227261220	CLEAR / RED / BLUE	2	0.20-2.5	40.2x13.8x10.2	25/250/2000	25
147-11074	5207227261268	CLEAR / RED / BLUE	4	0.20-2.5	40.2x25.1x10.2	25/250/2000	25

### ΚΛΕΜΜΑ ΑΝΤΑΠΤΟΡΑΣ TERMINAL ADAPTOR

- Production Material PC
- Amperage 32A



Code	Barcode	Color	Seats	Size(mm)	Dimensions(mm)	Packing	MOQ
147-11063	5207227260803	GREY / ORANGE	2	0.20-2.5	41.5x13.1x14.8	25/250/2000	25
147-11064	5207227260841	GREY / ORANGE	3	0.20-2.5	41.5x17.7x14.8	25/250/2000	25
147-11065	5207227260889	GREY / ORANGE	5	0.20-2.5	41.5x26.9x14.8	10/100/800	10
147-11066	5207227260926	GREY / RED / BLUE	4	0.20-2.5	41.5x23.7x14.8	25/250/2000	25
147-11067	5207227260964	GREY / RED / BLUE	6	0.20-2.5	41.5x31.9x14.8	10/100/800	10
147-11068	5207227261015	GREY/RED/BLUE/YELLOW	6	0.20-2.5	41.5x36x15	10/100/800	10
147-11069	5207227261060	GREY/RED/BLUE/YELLOW	9	0.20-2.5	41.5x48.8x15	10/100/800	10

### ΜΟΥΦΕΣ ΡΗΤΙΝΗΣ STRAIGHT JOINT PRE-FILLED WITH GEL

• Production Material PLASTIC & RESIN



Code	Barcode	Color	Dimensions(mm)	Packing	MOQ
147-11310	5207227278273	GREEN	42.4x38x26	1\20\600	1
147-11311	5207227278303	GREEN	52x38x26	1\15\450	1
147-11312	5207227278334	GREEN	74x46.2x26	1\10\300	1

### ΚΛΕΜΜΕΣ ΠΟΛΥΠΡΟΠΥΛΕΝΙΟΥ POLYPROPYLENE CONNECTABLE CONDUCTORS

• Production Material PP



Code	Barcode	Color	Seats	Size(mm)	Amperage	Dimensions(mm)	Packing	MOQ
147-11000	5206139111005	WHITE	12	2.5	3A	90.3x15.5x11.5	10\1200	10
147-11001	5206139111012	WHITE	12	4	3A	90.3x15.5x11.5	10\800	10
147-11002	5206139111029	WHITE	12	6	6A	110.5x15.5x12.4	10\1000	10
147-11003	5206139111036	WHITE	12	10	10A	116.7x20x14.9	10\500	10
147-11004	5206139111043	WHITE	12	16	30A	164.6x25x18.8	10\300	10
147-11005	5206139111050	WHITE	12	25	60A	187.6x29x23.5	10\200	10

### ΚΛΕΜΜΕΣ ΠΟΛΥΠΡΟΠΥΛΕΝΙΟΥ ΤΑΧΕΙΑΣ ΣΥΝΔΕΣΗΣ 20 ΤΜΧ TERMINAL BLOCKS POLYPROPYLENE QUICK CONNECTION 20 PCS

• Production Material PP & STAINLESS STEEL



Code	Barcode	Color	Seats	Size(mm)	Amperage	Dimensions(mm)	Packing	MOQ
147-11080	5207227328992	WHITE	2	1.5	10A	17x14x10.7	1\150	5
147-11081	5207227251214	WHITE	2	2.5	15A	20x17.5x13.5	1\150	5
147-11082	5207227329005	WHITE	3	1.5	10A	18x19.8x14.7	1\150	5
147-11083	5207227329012	WHITE	3	2.5	15A	19.8x28.8x14.7	1\150	5

### ΚΥΠΑΡΙΣΣΑΚΙ CONNECTION TERMINAL T8 SUPLEX

• Production Material POLYAMIDE



Code	Barcode	Color	Seats	Size(mm)	Amperage	Dimensions(mm)	Packing	MOQ
147-11200	5206139101006	GREY	8	16	16A	173x26.4x23.6	1\10\200	2
147-11201	5207227022715	GREY	8	25	16A	206x31.4x27	1\10\100	2
147-11202	5207227022708	GREY	8	35	16A	251x41.5x32.3	1\10\80	2
147-11203	5207227107252	GREY	8	50	16A	250x40x33	1\5\50	2
147-11204	5206139101044	GREY	8	70	16A	271x43.5x37.9	1\10\40	2

## ΜΠΑΡΑ ΟΥΔΕΤΕΡΟΥ ΡΑΓΑΣ DIN RAIL NEUTRAL CONNECTOR

• Production Material PA



147-11223



147-11227



Code	Barcode	Color	Seats	Amperage	Dimensions(mm)	Packing	MOQ
147-11220	5207227291067	BLUE	6	60A	58x10.4x35	40\1000	5
147-11221	5207227291098	BLUE	8	60A	78.4x10.4x35	20\500	5
147-11222	5207227291128	BLUE	10	60A	90x10.4x35	20\500	5
147-11223	5207227291159	BLUE	12	60A	103.5x10.4x35	20\500	5
147-11224	5207227291180	GREEN	6	60A	58x10.4x35	40\1000	5
147-11225	5207227291210	GREEN	8	60A	78.4x10.4x35	20\500	5
147-11226	5207227291241	GREEN	10	60A	90x10.4x35	20\500	5
147-11227	5207227291272	GREEN	12	60A	103.5x10.4x35	20\500	5

## ΜΠΛΟΚ ΔΙΑΝΟΜΗΣ ΡΑΓΑΣ DIN RAIL DISTRIBUTION BLOCK

• Production Material PA & PC



147-11230



147-11235



Code	Barcode	Color	Amperage	Dimensions(mm)	Packing	MOQ
147-11230	5207227291302	WHITE / BLUE	80A	64.5x28x48	5\200	2
147-11231	5207227291333	WHITE / BLUE	125A	74.2x28x48	5\150	2
147-11232	5207227291364	WHITE / BLUE	160A	74.2x28x48	5\150	2
147-11233	5207227291395	WHITE / BLUE	250A	95x47.5x51	3\60	2
147-11234	5207227291425	WHITE / BLUE	400A	95x47.5x51	3\60	2
147-11235	5207227291456	WHITE / BLUE	500A	95x47.5x51	3\60	2

## ΔΙΑΚΛΑΔΩΤΗΣ ΡΑΓΑΣ DIN RAIL DISTRIBUTION BUSBAR

• Production Material PA & PC



147-11240



147-11242



147-11243



147-11245



Code	Barcode	Color	Bars	Modules	Amperage	Dimensions(mm)	Packing	MOQ
147-11240	5207227291487	WHITE / BLUE	2	7	125A	66x44.5x51	1\100	2
147-11241	5207227291500	WHITE / BLUE	2	11	125A	100x44.5x51	1\100	2
147-11242	5207227291524	WHITE / BLUE	2	15	125A	132.5x44.5x51	1\100	2
147-11243	5207227291548	WHITE / BLUE	4	7	125A	66x86x51	1\100	2
147-11244	5207227291562	WHITE / BLUE	4	11	125A	100x86x51	1\50	2
147-11245	5207227291586	WHITE / BLUE	4	15	125A	132.5x86x51	1\50	2

## ΚΑΨΕΣ ΚΑΛΩΔΙΩΝ WIRE NUTS

• Production Material PA 66



147-02010 147-02011 147-02012



Code	Barcode	Color	Size(mm)	Amperage	Dimensions(mm)	Packing	MOQ
147-02010	5206139220103	ORANGE	1.5	16A	Ø11.5x20	1 BAG (100PCS) \ 100 BAGS	3
147-02011	5206139220110	YELLOW	2.5	16A	Ø13.5x23.5	1 BAG (100PCS) \ 50 BAGS	3
147-02012	5206139220127	RED	4	16A	Ø15.5x23.5	1 BAG (100PCS) \ 50 BAGS	3

## ΟΥΠΑ EXPAND WALL PLUGS

• Production Material PE



147-11300 147-11302 147-11303 147-11304



Code	Barcode	Color	Size	Dimensions(mm)	Packing	MOQ
147-11300	5207227032684	BLUE	No 6	Ø4x29.8	1 BAG (100PCS) \ 20000	5
147-11302	5207227032714	BLUE	No 8	Ø5x39.2	1 BAG (100PCS) \ 10000	5
147-11303	5207227032745	BLUE	No 10	Ø6x44	1 BAG (50PCS) \ 10000	5
147-11304	5207227032776	BLUE	No 12	Ø7x48.3	1 BAG (25PCS) \ 1000	5

## ΜΕΤΑΛΛΙΚΟ ΤΣΕΡΚΙ PERFORATED STEEL BANDING

• Production Material STEEL



Code	Barcode	Color	Diameter(mm)	Dimensions(mm)	Thickness (mm)	Packing	MOQ
147-08600	5207227107351	METALLIC	5m	10m x 12	0.60	1\20	1
147-08601	5207227107375	METALLIC	7m	10m x 17	0.70	1\20	1

## ΣΥΝΔΕΣΜΟΣ ΚΑΛΩΔΙΩΝ WATERPROOF WIRE CONNECTOR

• Production Material COPPER & NYLON



147-11030 147-11031 147-11032

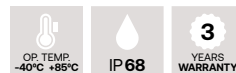

Code	Barcode	Color	Seats	CrosCable(mm)	Amperage	Dimensions(mm)	Packing	MOQ
147-11030	5207227059339	BLACK	3	3x1.5	16A	Ø27x73,5	1\10\400	10
147-11031	5207227059360	BLACK	3	3x1.5	16A	Ø25x108x69.2	1\10\200	10
147-11032	5207227329463	BLACK	3-5	3x2.5	16A	Ø32x114	1\10\200	10

## ΣΤΥΠΙΟΘΛΗΠΤΕΣ NYLON CABLE GLANDS

• Production Material PA66



Code	Barcode	Dimensions(mm)	Weight(kg)	Packing	MOQ
147-60000	5206139204004	Ø13.5x37	0.012	100/2000	50
147-60001	5206139204011	Ø16x40	0.011	100/1500	50
147-60002	5206139204028	Ø21x43	0.019	50/400	20
147-60003	5206139204035	Ø29x46	0.035	50/500	20
147-60004	5206139004932	Ø36x58	0.062	20/180	10

## ΑΤΣΑΛΙΝΕΣ ΠΛΑΣΤΙΚΕΣ ΓΕΡΜΑΝΙΑΣ PLASTIC PULL WIRE CABLE

• Production Material Polyamide

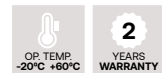

Code	Barcode	Color	Dimensions(mm)	Weight(kg)	Packing	MOQ
147-58000	5206139005328	WHITE	Ø3x500	0.064	1/10/200	3
147-58001	5206139005373	WHITE	Ø3x1000	0.103	1/10/150	3
147-58002	5206139014610	WHITE	Ø3x1500	0.143	1/10/120	3
147-58003	5206139018342	WHITE	Ø3x2000	0.165	1/10/80	3
147-58020	5207227107276	BLACK	Ø4x500	0.085	1/80	3
147-58021	5207227107290	BLACK	Ø4x1000	0.141	1/70	3
147-58022	5207227107313	BLACK	Ø4x1500	0.207	1/60	3
147-58023	5207227107337	BLACK	Ø4x2000	0.288	1/50	3

## ΓΕΙΩΣΗ ΧΑΛΚΟΥ, ΣΦΙΓΚΤΗΡΑΣ ΓΕΙΩΣΗΣ & ΜΟΥΦΑ COPPER GROUND, GROUND CABLE CLAMP & CONNECTOR

- Production Material Metallic. Copper & Brass
- Housing for waterproof power connection.
- Ideal for indoor and outdoor use.
- Two rubber seals for the cable entry and exit.



Code	Barcode	Dimensions	Weight(kg)	Packing	MOQ
147-08500	5207227031762	Ø16x1.5mm	1.8	10/1000	1
147-08501	5207227031779	Ø16x42mm	0.11	40/240	1
147-08502	520722789515	Ø16x70mm	0.092	50/250	1

**ΔΕΜΑΤΙΚΑ**  
CABLE TIES

- Production Material Nylon 66 94V-2 UL
- Color White
- Erosion Control & Resistance to high temperatures
- Raw material's country of origin: Vydyn® by USA

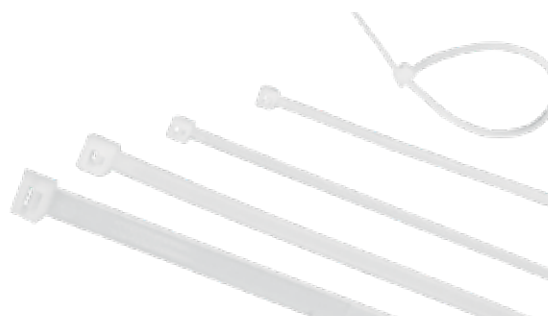
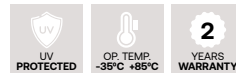

Code	Barcode	Size(mm)	Bundle Diam.	Newton (N)	Packing	MOQ
147-54002	5206139540027	120x2.5	2 ~ 30	80N	100pcs (Nylon Bag)\ 500Bags (in 1ctn)	5
147-54004	5206139540041	160x2.5	2 ~ 40	80N	100pcs (Nylon Bag)\ 500Bags (in 1ctn)	5
147-54005	5206139540058	200x2.5	2 ~ 50	80N	100pcs (Nylon Bag)\ 150Bags (in 1ctn)	5
147-54006	5206139004413	150x3.6	3 ~ 35	180N	100pcs (Nylon Bag)\ 104Bags (in 1ctn)	5
147-54007	5206139540072	200x3.6	3 ~ 50	180N	100pcs (Nylon Bag)\ 75Bags (in 1ctn)	5
147-54008	5206139540089	250x3.6	3 ~ 65	180N	100pcs (Nylon Bag)\ 75Bags (in 1ctn)	5
147-54009	5207227099090	300x3.6	3 ~ 80	180N	100pcs (Nylon Bag)\ 150Bags (in 1ctn)	5
147-54010	5207227099113	370x3.6	3 ~ 102	180N	100pcs (Nylon Bag)\ 120Bags (in 1ctn)	5
147-54012	5206139540126	200x4.8	3 ~ 50	220N	100pcs (Nylon Bag)\ 70Bags (in 1ctn)	5
147-54013	5206139540133	250x4.8	3 ~ 65	220N	100pcs (Nylon Bag)\ 120Bags (in 1ctn)	5
147-54014	5206139540140	300x4.8	3 ~ 82	220N	100pcs (Nylon Bag)\ 50Bags (in 1ctn)	5
147-54015	5206139540157	350x4.8	3 ~ 90	220N	100pcs (Nylon Bag)\ 40Bags (in 1ctn)	3
147-54016	5206139540164	450x4.8	3 ~ 130	220N	100pcs (Nylon Bag)\ 31Bags (in 1ctn)	3
147-54017	5206139004789	350x7.6	4 ~ 90	550N	100pcs (Nylon Bag)\ 25Bags (in 1ctn)	3
147-54018	5207227099137	450x7.6	4 ~ 120	550N	100pcs (Nylon Bag)\ 35Bags (in 1ctn)	3
147-54021	5206139540218	550x7.6	4 ~ 160	550N	100pcs (Nylon Bag)\ 15Bags (in 1ctn)	3
147-54022	5207227589652	650x7.6	4 ~ 160	550N	100pcs (Nylon Bag)\ 15Bags (in 1ctn)	3
147-54025	5207227589669	650x9	8 ~ 190	800N	100pcs (Nylon Bag)\ 15Bags (in 1ctn)	3
147-54027	5207227589676	760x9	8 ~ 240	800N	100pcs (Nylon Bag)\ 15Bags (in 1ctn)	3



**ΔΕΜΑΤΙΚΑ**  
CABLE TIES

- Production Material Nylon 66 94V-2 UL
- Color Black
- Erosion Control & Resistance to high temperatures
- Raw material's country of origin: Vydyne® by USA

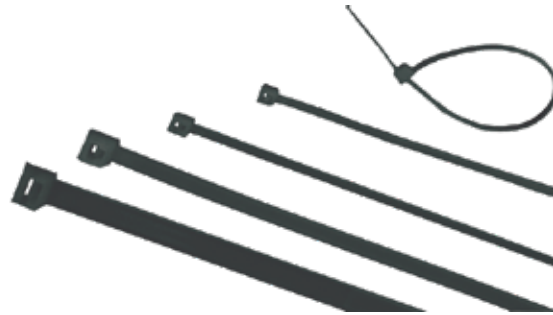
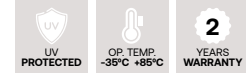

Code	Barcode	Size(mm)	Bundle Diam.	Newton (N)	Packing	MOQ
147-54102	5206139541024	120x2.5	2 ~ 30	80N	100pcs (Nylon Bag)\ 500Bags (in 1ctn)	5
147-54104	5206139541048	160x2.5	2 ~ 40	80N	100pcs (Nylon Bag)\ 500Bags (in 1ctn)	5
147-54105	5206139541055	200x2.5	2 ~ 50	80N	100pcs (Nylon Bag)\ 150Bags (in 1ctn)	5
147-54106	5206139541062	150x3.6	3 ~ 35	180N	100pcs (Nylon Bag)\ 104Bags (in 1ctn)	5
147-54107	5206139541079	200x3.6	3 ~ 50	180N	100pcs (Nylon Bag)\ 75Bags (in 1ctn)	5
147-54108	5206139541086	250x3.6	3 ~ 65	180N	100pcs (Nylon Bag)\ 75Bags (in 1ctn)	5
147-54109	5207227099151	300x3.6	3 ~ 80	180N	100pcs (Nylon Bag)\ 150Bags (in 1ctn)	5
147-54110	5207227099175	370x3.6	3 ~ 102	180N	100pcs (Nylon Bag)\ 120Bags (in 1ctn)	5
147-54112	5206139541123	200x4.8	3 ~ 50	220N	100pcs (Nylon Bag)\ 70Bags (in 1ctn)	5
147-54113	5206139541130	250x4.8	3 ~ 65	220N	100pcs (Nylon Bag)\ 120Bags (in 1ctn)	5
147-54114	5206139541147	300x4.8	3 ~ 82	220N	100pcs (Nylon Bag)\ 50Bags (in 1ctn)	5
147-54115	5206139541154	350x4.8	3 ~ 90	220N	100pcs (Nylon Bag)\ 40Bags (in 1ctn)	3
147-54116	5206139004796	450x4.8	3 ~ 130	220N	100pcs (Nylon Bag)\ 31Bags (in 1ctn)	3
147-54117	5206139004802	350x7.6	4 ~ 90	550N	100pcs (Nylon Bag)\ 25Bags (in 1ctn)	3
147-54118	5207227099199	450x7.6	4 ~ 120	550N	100pcs (Nylon Bag)\ 35Bags (in 1ctn)	3
147-54121	5206139015082	550x7.6	4 ~ 160	550N	100pcs (Nylon Bag)\ 15Bags (in 1ctn)	3
147-54122	5207227589683	650x7.6	4 ~ 190	550N	100pcs (Nylon Bag)\ 15Bags (in 1ctn)	3
147-54125	5207227589690	650x9	8 ~ 190	800N	100pcs (Nylon Bag)\ 15Bags (in 1ctn)	3
147-54127	5207227232541	760x9	8 ~ 240	800N	100pcs (Nylon Bag)\ 15Bags (in 1ctn)	3

**ΔΕΜΑΤΙΚΑ**  
CABLE TIES

- Production Material Nylon 66 94V-2 UL
- Color Green
- Erosion Control & Resistance to high temperatures
- Raw material's country of origin: Vydyne® by USA

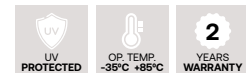

Code	Barcode	Size(mm)	Bundle Diam.	Newton (N)	Packing	MOQ
147-54062	5206139050199	200x2.5	2 ~ 50	80N	100pcs (Nylon Bag)\ 150Bags (in 1ctn)	5

## POKA CABLE CLIP

- Production Material PE & STEEL
- Ατσαλόκαρφο Γερμανίας / Germany Steel

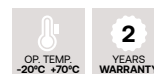

Code	Barcode	Color	Size	Height(mm)	Weight(kg)	Packing	MOQ
147-48000	5206139067593	WHITE	5/20	6	0.065	100\300	5
147-48001	5206139067609	WHITE	6/25	8	0.080	100\200	5
147-48002	5206139067616	WHITE	7/25	8.7	0.085	100\200	5
147-48003	5206139067623	WHITE	8/25	9.5	0.106	100\200	5
147-48004	5206139067630	WHITE	9/25	11	0.121	100\100	5
147-48005	5206139067647	WHITE	10/25	12	0.141	100\100	5
147-48010	5206139067746	WHITE	6/35	8	0.098	100\200	5
147-48011	5206139067753	WHITE	7/35	8.7	0.101	100\200	5
147-48012	5206139067760	WHITE	8/35	9.5	0.128	100\100	5
147-48013	5206139067777	WHITE	9/35	11	0.145	100\100	5
147-48014	5206139067784	WHITE	10/35	12	0.158	100\100	5
147-48015	5206139067791	WHITE	12/35	13.5	0.203	100\100	5
147-48016	5206139067807	WHITE	14/35	16.5	0.258	100\100	5
147-48017	5206139067814	WHITE	16/35	18	0.301	100\50	5
147-48019	5206139067821	WHITE	20/45	22.5	0.251	50\50	5
147-48020	5206139067845	WHITE	22/45	23.5	0.285	50\50	5
147-48031	5207227060816	BLACK	6/25	8	0.080	100\200	5
147-48032	5207227060830	BLACK	7/25	8.7	0.085	100\200	5
147-48033	5207227060854	BLACK	8/25	9.5	0.106	100\200	5
147-48034	5207227060878	BLACK	9/25	11	0.121	100\100	5

## ΑΥΤΟΚΟΛΛΗΤΕΣ ΒΑΣΕΙΣ SELF ADHESIVE TIE MOUNTS

- Production Material ABS

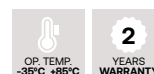

Code	Barcode	Color	Size	Height(mm)	Weight(kg)	Packing	MOQ
147-54033	5206139540331	WHITE	20/20	6.1	0.010	100pcs (Nylon Bag)\ 160Bags (in 1ctn)	2
147-54034	5206139540348	WHITE	30/30	8.7	0.030	100pcs (Nylon Bag)\ 70Bags (in 1ctn)	2

ΣΕΤ ΘΕΡΜΟΣΥΣΤΕΛΛΟΜΕΝΩΝ ΚΑΛΩΔΙΩΝ  
HEAT SHRINKABLE TUBINGS SET

• Production Material EVA



Code	Barcode	I.D.(mm)	Thickness	Color	Packing	MOQ
147-11020	5207227000058	2.5	0.25	RED	1\16	1
		4.0	0.25	YELLOW		
		6.0	0.35	BLUE		
		8.0	0.35	RED		
		10.0	0.35	GREEN		
		12.0	0.35	BLACK		
		16.0	0.35	BLUE		
		18.0	0.4	WHITE		
		20.0	0.5	BLACK		





**ΑΝΤΑΠΤΟΡΑΣ SOLAR**  
SOLAR CONNECTORS

• Production Material PC



Code	Barcode	Color	Amperage	Type	Voltage	Dimensions(mm)	Packing	MOQ
147-11400	5207227218910	BLACK	30A	MALE	1000V	190x190x570	1\2000	1
147-11401	5207227218927	BLACK	30A	FEMALE	1000V	190x190x560	1\2000	1
147-11404	5207227503689	BLACK	50A	MALE	1500V	198x198x660	1\1000	10
147-11405	5207227503719	BLACK	50A	FEMALE	1500V	198x198x660	1\1000	10
147-11406	5207227503740	BLACK	50A	MALE	1500V	198x198x660	1\1000	10
147-11407	5207227503771	BLACK	50A	FEMALE	1500V	198x198x660	1\1000	10

**ΑΝΤΑΠΤΟΡΑΣ SOLAR**  
SOLAR CONNECTORS

• Production Material PPO



147-11410/11 147-11412/13 147-11414/15 147-11416/17



Code	Barcode	Color	Amperage	Voltage	Dimensions(mm)	Packing	MOQ
147-11410	5207227218934	BLACK	50A	1000V	1090x408x200	1\250	1
147-11411	5207227218941	BLACK	50A	1000V	1090x408x200	1\250	1
147-11412	5207227218958	BLACK	50A	1000V	1090x630x200	1\250	1
147-11413	5207227218965	BLACK	50A	1000V	1090x630x200	1\250	1
147-11414	5207227218972	BLACK	30A	1000V	3000x400x190	1\200	1
147-11415	5207227218989	BLACK	30A	1000V	3000x400x190	1\200	1
147-11416	5207227218996	BLACK	30A	1000V	3000x2900x190	1\100	1
147-11417	5207227219009	BLACK	30A	1000V	3000x2900x190	1\100	1



ΥΛΙΚΑ  
ΦΩΤΙΣΤΙΚΩΝ  
LIGHTING HARDWARE

ΝΤΟΥΙ  
LAMP HOLDERS

ΝΤΟΥΙ ΚΡΕΜΑΣΤΑ  
PENDANT LAMP HOLDERS

ΡΟΖΕΤΕΣ ΟΡΟΦΗΣ  
CEILING METAL ROSE CUPS

## ΝΤΟΥΙ ΒΑΚΕΛΙΤΟΥ BAKLITE LAMP HOLDERS



Code	Barcode	Color	IP	Description	Base Holder	Packing	MOQ
147-23008	5207227099298	WHITE	IP20	2 RINGS	E14	20\200	20
147-23009	5207227099236	WHITE	IP20	2 RINGS	E27	20\200	20
147-23010	5206139108104	BLACK	IP20	2 RINGS	E14	30\300	30
147-23011	5206139108111	BLACK	IP20	2 RINGS	E27	20\200	30
147-23029	5207227150340	BLACK	IP20	SIMPLE	E27	10\50\500	10
147-23030	5206139108302	WHITE	IP20	SIMPLE	E27	10\50\500	10
147-23031	5206139108319	WHITE	IP20	SIMPLE	E14	1\50\1200	20
147-23032	5206139108326	BLACK	IP20	SIMPLE	E14	1\50\1200	20
147-23036	5207227041891	BLACK	IP20	FAST CONNECTION	E27	1\10\500	10
147-23037	5207227068607	BLACK	IP44	GARLAND	E27	1\12\600	12

## ΝΤΟΥΙ ΠΟΡΣΕΛΑΝΗΣ PORCELAIN LAMP HOLDERS



Code	Barcode	Color	IP	Description	Base Holder	Packing	MOQ
147-23000	5206139108005	WHITE	IP20	PORCELAIN 1/8	E27	20\200	20
147-23002	5206139108029	WHITE	IP20	FOR SPOT	E27	20\200	20
147-23003	5206139108036	WHITE	IP20	FOR GUTTER	E27	20\200	20
147-23004	5206139108043	WHITE	IP20	PLAIN	E27	20\200	10
147-23016	5206139108166	WHITE	IP20	WITH TWO BARS	E27	20\200	20
147-23018	5206139108180	WHITE	IP20	CAP	E27	20\200	20
147-23020	5206139108203	WHITE	IP20	WITH BAR	E40	1\80	10
147-23022	5206139108227	WHITE	IP20	PLAIN	E40	10\100	10
147-23081	5206139067265	BLACK	IP20	BARREL	E27	10\100	10
147-23012	5206139108128	WHITE	IP20	CABLE 15cm	GU10	50\500	30
147-23013	5207227069208	WHITE	IP20	CABLE 25cm	GU10	50\500	30
147-23014	5206139108142	WHITE	IP20	CABLE 15cm	G9	100\1000	20
147-23015	5206139108159	WHITE	IP20	CABLE 15cm	G12	10\200	10

**ΝΤΟΥΙ ΜΕΤΑΛΛΙΚΑ**  
METAL LAMPHOLDERS



Code	Barcode	Color	IP	Description	Base Holder	Packing	MOQ
<b>147-23042</b>	5206139020123	NICKEL	IP20	2 RINGS	E14	32\320	10
<b>147-23043</b>	5206139020130	NICKEL	IP20	2 RINGS	E27	32\256	10
<b>147-23044</b>	5206139020147	GOLD	IP20	2 RINGS	E14	25\200	10
<b>147-23045</b>	5206139020154	GOLD	IP20	2 RINGS	E27	32\256	10

**ΝΤΟΥΙ ΟΡΕΙΧΑΛΚΙΝΑ**  
BRASS LAMPHOLDERS



Code	Barcode	Color	IP	Description	Base Holder	Packing	MOQ
<b>147-23040</b>	5206139108401	BRASS	IP20	SIMPLE	E14	50\1000	20
<b>147-23041</b>	5206139108418	BRASS	IP20	SIMPLE	E27	20\400	20

**ΝΤΟΥΙ ΑΝΤΑΓΓΟΡΕΣ**  
LAMPHOLDER ADAPTERS



Code	Barcode	Color	IP	Description	Base Holder	Packing	MOQ
<b>147-23050</b>	5206139108449	WHITE	IP20	FROM E27 TO E40	PLASTIC	10\500	5
<b>147-23051</b>	5206139108456	WHITE	IP20	FROM E40 TO E27	PLASTIC	25\500	5
<b>147-23052</b>	5206139108463	WHITE	IP20	FROM E14 TO GU10	PLASTIC	12\360	12
<b>147-23053</b>	5206139108470	WHITE	IP20	FROM E14 TO G9	PLASTIC	12\600	12
<b>147-23054</b>	5206139108487	WHITE	IP20	FROM E27 TO E14	PLASTIC	12\600	12
<b>147-23055</b>	5206139108494	WHITE	IP20	FROM B22 TO E27	PLASTIC	12\600	12
<b>147-23056</b>	5206139009920	WHITE	IP20	FROM E27 TO GU10	PLASTIC	12\360	12
<b>147-23057</b>	5206139053817	WHITE	IP20	FROM E14 TO E27	PLASTIC	12\600	12
<b>147-23058</b>	5207227451331	WHITE	IP20	FROM B22 TO E14	PLASTIC	12\240	12
<b>147-23059</b>	5207227451348	WHITE	IP20	FROM E27 TO 2xE27	PLASTIC	12\600	12

## ΝΤΟΥΙ ΚΡΕΜΑΣΤΑ PENDANT LAMPHOLDERS



147-23150



147-23151



147-23152



147-23153



147-23155

Code	Barcode	Color (Base / Cable)	Material	Dimensions(mm)	Packing	MOQ
147-23150	5207227055645	NICKEL/GREEN-BEIGE	METALLIC & ROPE	Ø100x1000	1\50	1
147-23151	5207227055652	NICKEL/RED-GREY	METALLIC & ROPE	Ø100x1000	1\50	1
147-23152	5207227055669	BLACK/WHITE-BLACK	METALLIC & ROPE	Ø100x1000	1\50	1
147-23153	5207227055676	BLACK/WHITE-GREY	METALLIC & ROPE	Ø100x1000	1\50	1
147-23155	5207227206016	WHITE	METALLIC & ROPE	Ø100x1000	1\50	1

## ΡΟΖΕΤΕΣ ΟΡΟΦΗΣ / ΝΤΟΥΙ CEILING METAL ROSE CUPS

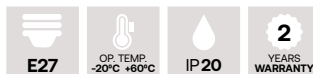

147-23075



147-23071



147-23077



147-23065



147-23061



147-23067

Code	Barcode	Color	Material	Dimensions(mm)	Packing	MOQ
------	---------	-------	----------	----------------	---------	-----

### ΡΟΖΕΤΕΣ ΟΡΟΦΗΣ / METAL ROSE CUP

147-23071	5206139073730	ANTIQU BRASS	METAL	Ø100x25	1\20\100	1
147-23075	5206139044587	BLACK	METAL	Ø100x25	1\20\100	1
147-23077	5206139073808	BROWN BRONZE	METAL	Ø100x25	1\20\100	1

### ΝΤΟΥΙ / LAMPHOLDERS

147-23061	5206139034540	ANTIQU BRASS	METAL	Ø50x70	1\20\100	1
147-23065	5207227144011	BLACK	METAL	Ø50x70	1\20\100	1
147-23067	5206139067371	BROWN BRONZE	METAL	Ø50x70	1\20\100	1

## ΚΑΛΩΔΙΟ ΚΟΡΔΟΝΙ ΧΡΩΜΑΤΙΣΤΟ COLORED CORD TYPE CABLE



147-13313

147-13310

147-13305



Code	Barcode	Color	Material	Length(m)	Packing	MOQ
147-13305	5206139033666	BROWN	ROPE, ALUMINIUM & PLASTIC	50	50m/roll	50
147-13310	5206139033727	BLACK	ROPE, ALUMINIUM & PLASTIC	50	50m/roll	50
147-13313	5206139073846	WHITE	ROPE, ALUMINIUM & PLASTIC	50	50m/roll	50

ΝΤΟΥΙ ΚΡΕΜΑΣΤΑ  
PENDANT LAMPHOLDERS



Code	Barcode	Color (Base / Cable)	Material	Dimensions(mm)	Packing	MOQ
147-10009	5206139100092	WHITE	PLASTIC & PORCELAIN	Ø60x240	1\25\300	10
147-23100	5206139108432	WHITE	PLASTIC	Ø74x640	1\50	5
147-23110	5206139025234	WHITE	PLASTIC	Ø90x940	1\50	1
147-23120	5206139025241	NICKEL	PLASTIC & METAL	Ø100x620	1\50	1
147-23121	5206139025258	ANTIQUE BRASS	PLASTIC & METAL	Ø100x620	1\50	1
147-23130	5206139027764	NICKEL SATIN	PLASTIC & METAL	Ø100x620	1\50	1
147-23131	5206139027771	BRONZE	PLASTIC & METAL	Ø100x620	1\50	1



Code	Barcode	Color (Base / Cable)	Material	Dimensions(mm)	Packing	MOQ
147-23160	5207227206030	WHITE	METAL & ROPE	Ø100x1000	1\36	1
147-23161	5207227206054	BLACK	METAL & ROPE	Ø100x1000	1\36	1
147-23162	5207227206078	NATURAL	METAL & ROPE	Ø100x1000	1\36	1
147-23170	5207227206092	WOOD BROWN	WOOD	Ø100x1000	1\64	1
147-23171	5207227206115	WOOD BROWN	WOOD	Ø100x1000	1\36	1



ΒΑΣΗ ΓΛΟΜΠΟΥ ΒΑΚΕΛΙΤΟΥ  
BAKELITE GLOBE BASE WITH LAMPHOLDER



Code	Barcode	Color	Material	Dimensions(mm)	Packing	MOQ
147-22003	5206139108531	WHITE	PLASTIC & CERAMIC	Ø90x60	1\10\100	10
147-22004	5206139108548	WHITE	PLASTIC & CERAMIC	Ø90x60	1\10\100	10

ΓΥΑΛΙ ΓΛΟΜΠΟΥ  
GLASS FOR GLOBE



Code	Barcode	Color	Material	Dimensions(mm)	Packing	MOQ
153-65999	5206139519993	WHITE	GLASS	Ø160	1\16	1





**ΑΝΑΛΩΣΙΜΟ  
ΥΛΙΚΟ  
CONSUMABLES**

**ΚΑΝΑΛΙΑ  
CABLE TRUNKING**

**ΔΟΜΗΜΕΝΗ ΚΑΛΩΔΙΩΣΗ  
STRUCTURED CABLING**

**ΕΞΑΡΤΗΜΑΤΑ ΔΟΜΗΜΕΝΗΣ ΚΑΛΩΔΙΩΣΗΣ  
STRUCTURED CABLING ACCESSORIES**

**ΣΩΛΗΝΕΣ ΕΥΘΕΙΑΣ & ΣΠΙΡΑΛ  
STRAIGHT TUBES & SPIRAL**

## ΚΑΝΑΛΙΑ ΚΛΕΙΣΤΟΥ ΤΥΠΟΥ

### CLOSED TYPE CABLE TRUNKING

- Production Material PVC UL 94, VO M1
- Temperature -25°C / +60°C
- Corrosion resistance YES
- Flame spread resistance YES

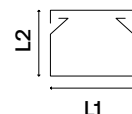

Code	Barcode	Color	Size (L1xL2)	Length(m)	Weight(kg)	Packing	Packaging Size	MOQ
<b>CARTON BOX PACKAGING</b>								
160-56000	5206139560001	WHITE	12x12	2	0.055	144m	12.5cm x 9cm x 2.01m	144m
160-56001	5206139560018	WHITE	15x10	2	0.060	126m	12.5cm x 9cm x 2.01m	126m
160-56002	5206139560025	WHITE	16x16	2	0.080	72m	12.5cm x 9cm x 2.01m	72m
160-56003	5206139560032	WHITE	20x10	2	0.080	90m	12.5cm x 9cm x 2.01m	90m
160-56004	5206139560049	WHITE	25x16	2	0.125	168m	12.5cm x 9cm x 2.01m	168m
160-56005	5206139560056	WHITE	25x25	2	0.155	100m	12.5cm x 9cm x 2.01m	100m
160-56009	5206139560094	WHITE	40x16	2	0.180	98m	12.5cm x 9cm x 2.01m	98m
160-56010	5206139560100	WHITE	40x25	2	0.200	80m	12.5cm x 9cm x 2.01m	80m
160-56011	5206139560117	WHITE	40x40	2	0.260	72m	12.5cm x 9cm x 2.01m	72m
160-56013	5206139560131	WHITE	60x40	2	0.390	48m	12.5cm x 9cm x 2.01m	48m
160-56014	5206139560148	WHITE	60x60	2	0.475	40m	12.5cm x 9cm x 2.01m	40m
160-56015	5206139560155	WHITE	80x40	2	0.480	36m	12.5cm x 9cm x 2.01m	36m
160-56016	5206139560162	WHITE	80x60	2	0.620	24m	12.5cm x 9cm x 2.01m	24m
160-56017	5206139560179	WHITE	100x40	2	0.630	28m	12.5cm x 9cm x 2.01m	28m
160-56018	5206139560186	WHITE	100x60	2	0.750	24m	12.5cm x 9cm x 2.01m	24m
160-56019	5207227124273	WHITE	120x60	2	0.960	20m	12.5cm x 9cm x 2.01m	20m
<b>NYLON BAG PACKAGING</b>								
160-56030	5207227038129	WHITE	12x12	2	0.055	30m	12.5cm x 9cm x 2.01m	30m
160-56032	5207227038167	WHITE	16x16	2	0.080	30m	12.5cm x 9cm x 2.01m	30m
160-56033	5207227038181	WHITE	20x10	2	0.080	30m	12.5cm x 9cm x 2.01m	30m
160-56034	5207227038204	WHITE	25x16	2	0.125	20m	12.5cm x 9cm x 2.01m	20m
160-56035	5207227038228	WHITE	25x25	2	0.155	20m	12.5cm x 9cm x 2.01m	20m
160-56038	5207227038266	WHITE	40x25	2	0.200	20m	12.5cm x 9cm x 2.01m	20m
160-56039	5207227038280	WHITE	40x40	2	0.260	20m	12.5cm x 9cm x 2.01m	20m
160-56040	5207227039652	WHITE	60x40	2	0.390	20m	12.5cm x 9cm x 2.01m	20m
160-56041	5207227039676	WHITE	60x60	2	0.475	20m	12.5cm x 9cm x 2.01m	20m

## ΚΑΝΑΛΙΑ ΔΑΠΕΔΟΥ ΑΥΤΟΚΟΛΛΗΤΑ & ΑΠΛΑ

### ADHESIVE AND NON ADHESIVE FLOOR CABLE TRUNKING

- Production Material PVC UL 94, VO M1
- Temperature -25°C / +60°C
- Corrosion resistance YES
- Flame spread resistance YES

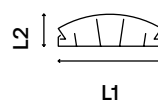

Code	Barcode	Color	Size (L1xL2)	Length(mm)	Weight(kg)	Packing	Packaging Size	MOQ
<b>ΑΠΛΑ / SIMPLE</b>								
160-56150	5206139561503	GREY	50x12	2000	0.300	60m	12.5cm x 9cm x 2.01m	60m
160-56151	5206139561510	GREY	70x20	2000	0.480	60m	12.5cm x 9cm x 2.01m	60m
160-56152	5207227269653	GREY	90x20	2000	0.597	40m	12.5cm x 9cm x 2.01m	40m
<b>ΑΥΤΟΚΟΛΛΗΤΑ / ADHESIVE</b>								
160-56050	5206139560506	GREY	50x12	2000	0.253	60m	12.5cm x 9cm x 2.01m	60m
160-56051	5206139560513	GREY	70x20	2000	0.465	60m	12.5cm x 9cm x 2.01m	60m
160-56052	5207227269622	GREY	90x20	2000	0.597	40m	12.5cm x 9cm x 2.01m	40m

**ΚΑΝΑΛΙΑ ΑΥΤΟΚΟΛΛΗΤΑ**  
ADHESIVE CABLE TRUNKING

- Production Material PVC UL 94, VO M1
- Temperature -25°C / +60°C
- Corrosion resistance YES
- Flame spread resistance YES

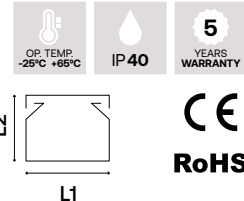

Code	Barcode	Color	Size (L1xL2)	Length(m)	Weight(kg)	Packing	Packaging Size	MOQ
<b>CARTON BOX PACKAGING</b>								
160-56100	5206139561008	WHITE	12x12	2m	0.058	144m	12.5cm x 9cm x 2.01m	144m
160-56101	5206139561015	WHITE	15x10	2m	0.065	126m	12.5cm x 9cm x 2.01m	126m
160-56102	5206139561022	WHITE	16x16	2m	0.088	72m	12.5cm x 9cm x 2.01m	72m
160-56103	5206139561039	WHITE	20x10	2m	0.082	90m	12.5cm x 9cm x 2.01m	90m
160-56104	5206139561046	WHITE	25x16	2m	0.134	168m	12.5cm x 9cm x 2.01m	168m
160-56105	5206139561053	WHITE	25x25	2m	0.165	100m	12.5cm x 9cm x 2.01m	100m
160-56109	5206139561091	WHITE	40x16	2m	0.195	98m	12.5cm x 9cm x 2.01m	98m
160-56110	5206139561107	WHITE	40x25	2m	0.245	80m	12.5cm x 9cm x 2.01m	80m
160-56111	5206139561114	WHITE	40x40	2m	0.275	72m	12.5cm x 9cm x 2.01m	72m
<b>NYLON BAG PACKAGING</b>								
160-56130	5207227038303	WHITE	12x12	2m	0.058	30m	12.5cm x 9cm x 2.01m	30m
160-56131	5207227038327	WHITE	15x10	2m	0.065	30m	12.5cm x 9cm x 2.01m	30m
160-56132	5207227038341	WHITE	16x16	2m	0.088	30m	12.5cm x 9cm x 2.01m	30m
160-56133	5207227038365	WHITE	20x10	2m	0.082	30m	12.5cm x 9cm x 2.01m	30m
160-56134	5207227038389	WHITE	25x16	2m	0.134	20m	12.5cm x 9cm x 2.01m	20m
160-56135	5207227038402	WHITE	25x25	2m	0.165	20m	12.5cm x 9cm x 2.01m	20m
160-56137	5207227038426	WHITE	40x16	2m	0.195	20m	12.5cm x 9cm x 2.01m	20m
160-56138	5207227038440	WHITE	40x25	2m	0.245	20m	12.5cm x 9cm x 2.01m	20m
160-56139	5207227038464	WHITE	40x40	2m	0.275	20m	12.5cm x 9cm x 2.01m	20m



## ΚΑΝΑΛΙ ΔΟΜΗΜΕΝΗΣ ΚΑΛΩΔΙΩΣΗΣ

### STRUCTURED CABLE TRUNKING

• Production Material PVC UL 94. VO M1

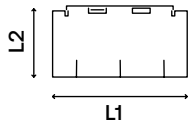

Code	Barcode	Color	Size (L1xL2)	Length(mm)	Weight(kg)	Packing	MOQ
160-56300	5206139563002	WHITE	100x50	2000	1.100	20m	20m

## ΓΩΝΙΕΣ ΔΟΜΗΜΕΝΗΣ ΚΑΛΩΔΙΩΣΗΣ

### STRUCTURED ANGLES

• Production Material PVC UL 94. VO M1

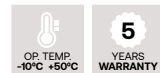

Code	Barcode	Description	Color	Weight(kg)	Packing	MOQ
160-56310	5206139563101	ΕΣΩΤΕΡΙΚΗ / INNER	WHITE	0.060	1/12	1
160-56311	5206139563118	ΕΞΩΤΕΡΙΚΗ / EXTERNAL	WHITE	0.075	1/12	1

## ΤΑΦ ΔΟΜΗΜΕΝΗΣ ΚΑΛΩΔΙΩΣΗΣ

### STRUCTURED T SHAPE TRUNKING CONNECTOR

• Production Material PVC UL 94. VO M1

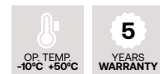

Code	Barcode	Color	Size	Weight(kg)	Packing	MOQ
160-56312	5206139563101	WHITE	100x50	0.069	1/10	1

## ΓΩΝΙΑ 90° ΔΟΜΗΜΕΝΗΣ ΚΑΛΩΔΙΩΣΗΣ

### ANGLE 90° STRUCTURED

• Production Material PVC UL 94. VO M1



Code	Barcode	Color	Sizes	Weight(kg)	Packing	MOQ
160-56313	5206139563132	WHITE	100x50	0.066	1/12	1

## ΤΑΠΑ ΔΟΜΗΜΕΝΗΣ ΚΑΛΩΔΙΩΣΗΣ

### END CAP STRUCTURED

• Production Material PVC UL 94. VO M1

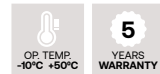

Code	Barcode	Color	Size	Weight(kg)	Packing	MOQ
160-56314	5206139563149	WHITE	100x50	0.009	1/24	1

## ΣΥΝΔΕΣΜΟΣ ΓΙΑ ΚΑΠΑΚΙ

### JUNCTION FOR COVER

• Production Material PVC UL 94. VO M1



Code	Barcode	Color	Size	Weight(kg)	Packing	MOQ
160-56315	5206139563156	WHITE	100x50	0.009	1/24	1

## ΕΣΩΤΕΡΙΚΟ ΔΙΑΧΩΡΙΣΤΙΚΟ ΓΙΑ ΚΑΝΑΛΙ

### SEPERATOR FOR CABLE TRUNKING

• Production Material PVC UL 94. VO M1



Code	Barcode	Color	Weight(kg)	Packing	MOQ
160-56316	5206139563163	WHITE	0.055	100m	1

## ΚΑΝΑΛΙ ΔΟΜΗΜΕΝΗΣ ΚΑΛΩΔΙΩΣΗΣ STRUCTURED CABLE TRUNKING

• Production Material PVC UL 94. VO M1

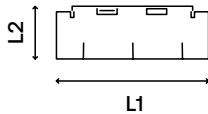

Code	Barcode	Color	Size (L1xL2)	Length(mm)	Weight(kg)	Packing	MOQ
160-56301	5206139563019	WHITE	100x35	2000	0.748	24m	24m

## ΓΩΝΙΕΣ ΔΟΜΗΜΕΝΗΣ STRUCTURED ANGLES

• Production Material PVC UL 94. VO M1

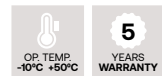

Code	Barcode	Description	Color	Weight(kg)	Packing	MOQ
160-56330	5207227568749	ΕΣΩΤΕΡΙΚΗ / INNER	WHITE	0.060	1/12	1
160-56331	5207227568763	ΕΞΩΤΕΡΙΚΗ / EXTERNAL	WHITE	0.075	1/12	1

## ΤΑΦ ΔΟΜΗΜΕΝΗΣ ΚΑΛΩΔΙΩΣΗΣ STRUCTURED T SHAPE TRUNKING CONNECTOR

• Production Material PVC UL 94. VO M1

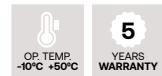

Code	Barcode	Color	Size	Weight(kg)	Packing	MOQ
160-56332	5207227568787	WHITE	100x35	0.069	1/10	1

## ΓΩΝΙΑ 90° ΔΟΜΗΜΕΝΗΣ ΚΑΛΩΔΙΩΣΗΣ ANGLE 90° STRUCTURED

• Production Material PVC UL 94. VO M1

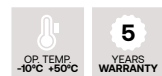

Code	Barcode	Color	Sizes	Weight(kg)	Packing	MOQ
160-56333	5207227568800	WHITE	100x35	0.066	1/12	1

## ΤΑΠΑ ΔΟΜΗΜΕΝΗΣ ΚΑΛΩΔΙΩΣΗΣ END CAP STRUCTURED

• Production Material PVC UL 94. VO M1

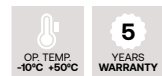

Code	Barcode	Color	Size	Weight(kg)	Packing	MOQ
160-56334	5207227568824	WHITE	100x35	0.009	1/24	1

## ΣΥΝΔΕΣΜΟΣ ΓΙΑ ΚΑΠΑΚΙ JUNCTION FOR COVER

• Production Material PVC UL 94. VO M1

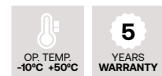

Code	Barcode	Color	Size	Weight(kg)	Packing	MOQ
160-56335	5207227568848	WHITE	100x35	0.009	1/24	1

## ΠΛΑΙΣΙΑ ΔΟΜΗΜΕΝΗΣ ΚΑΛΩΔΙΩΣΗΣ FRAME SET FOR STRUCTURED

• Production Material ABS

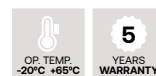

Code	Barcode	Description	Weight(kg)	Packing	MOQ
160-56320	5206139563200	ΜΟΝΟ / SINGLE	0.018	1/100	1
160-56321	5206139563217	ΔΙΠΛΟ / DOUBLE	0.025	1/100	1
160-56322	5206139563224	ΤΡΙΠΛΟ / TRIPLE	0.041	1/100	1
160-56323	5206139563231	ΤΕΤΡΑΠΛΟ / QUADRUPLE	0.056	1/100	1
160-56324	5206139563248	ΜΟΝΟ ΔΙΑΦΟΡΩΝ ΔΙΑΚΟΠΤΩΝ SINGLE FOR DIFFERENT KINDS OF SWITCHES	0.018	1/100	1

## ΠΛΗΚΤΡΑ ΤΗΛΕΦΩΝΟΥ DATA TELEPHONE FRAMES

• Production Material ABS

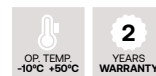

Code	Barcode	Description	Packing	MOQ
160-16002	5206139160027	ΜΟΝΟ / SINGLE 45X45	1/100	1
160-16003	5206139160034	ΜΟΝΟ / SINGLE 22.5X45	1/100	1
160-16004	5206139160041	ΔΙΠΛΟ / DOUBLE 45X45	1/100	1
160-16012	5207227158483	ΔΙΠΛΟ ΤΥΦΛΟ / DOUBLE BLIND	1/100	1
160-16013	5207227158490	ΜΟΝΟ ΤΥΦΛΟ / SINGLE BLIND	1/100	1

## ΦΙΣ CONNECTOR TELEPHONE CONNECTOR

• Production Material ABS



Code	Barcode	Description	Dimensions(mm)	Packing	MOQ
160-10000	5206139800008	RG 11 CAT 3	19x17x35	1\100	1
160-10001	5206139800015	RG 45 CAT 6e	18x15x30	1\100	1
160-10002	5207227558436	RG 45 CAT 5e	18x15x30	1/100	2

NEW

## ΠΡΙΖΕΣ ΣΟΥΚΟ SCHUKO SOCKETS

• Production Material ABS



**2**  
YEARS  
WARRANTY

Code	Barcode	Description	Amperage	Dimensions(mm)	Weight(kg)	Packing	MOQ
160-16000	5206139160003	16A	16A	33x45x45	0.037	1\50	1
160-16001	5206139160010	UPS 16A	16A	33x45x45	0.040	1\50	1
160-16010	5207227158452	DOUBLE 16A	16A	90x45x40	0.060	1\30	1
160-16011	5207227158469	TRIPLE 16A	16A	135x45x40	0.090	1\20	1

## ΠΡΙΖΑ UK UK TYPE SOCKET

• Production Material PVC  
• 16A

**NEW**



OP. TEMP.  
-10°C +50°C

IP 40

**5**  
YEARS  
WARRANTY

Code	Barcode	Color	Dimensions(mm)	Weight(kg)	Packing	MOQ
160-16014	5207227558498	WHITE	37x45x45	0.043	1\4\24	1

## ΠΡΙΖΕΣ ΤΗΛΕΟΡΑΣΗΣ TV SOCKETS

• Production Material Plastic & Aluminium



IP 20

**5**  
YEARS  
WARRANTY

Code	Barcode	Description	Dimensions(mm)	Weight(kg)	Packing	MOQ
160-16005	5206139160058	ΔΙΕΛΕΥΣΕΩΣ / TRANSIT	30x45x45	0.035	1/50	1
160-16006	5206139160065	ΔΟΡΥΦΟΡΙΚΗ / SATELITE	30x45x45	0.035	1/50	1
160-16007	5207227158476	2 USBS 5V 2x2.2A	22.5x45x45	0.035	1/50	1
160-16008	5207227558467	USB-TYPE C 5V 2X2,2A	22.5x45x45	0.035	1/50	1

**NEW**

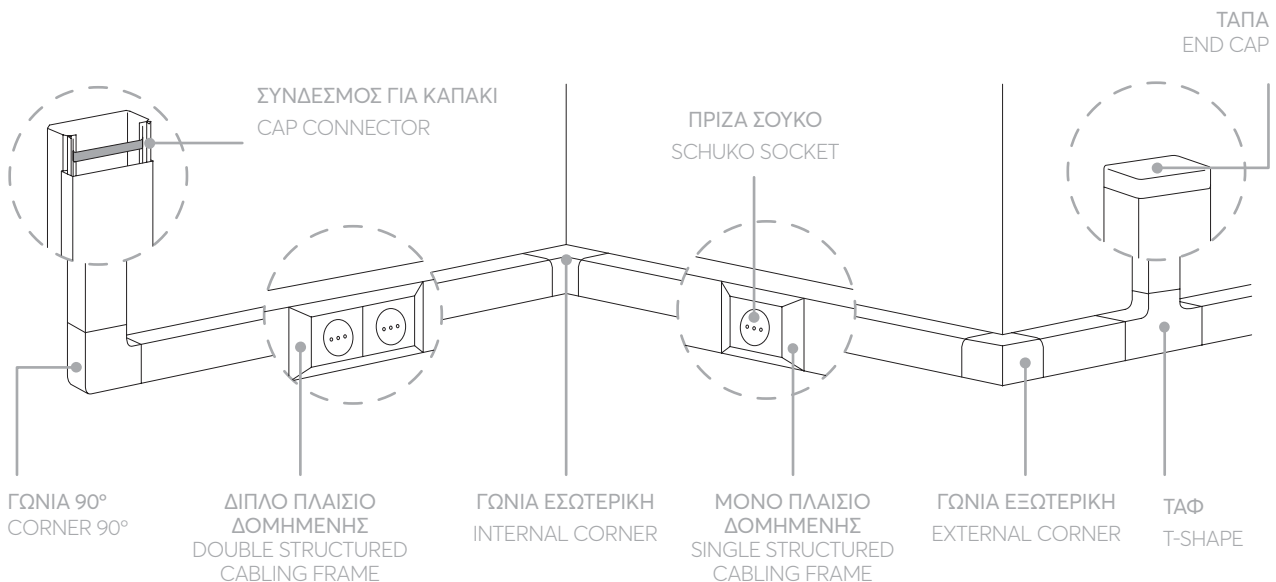

## ΣΩΛΗΝΕΣ ΕΥΘΕΙΑΣ ΜΕΣΑΙΟΥ ΤΥΠΟΥ

### MEDIUM TYPE RIGID CONDUITS

• Production Material PVC

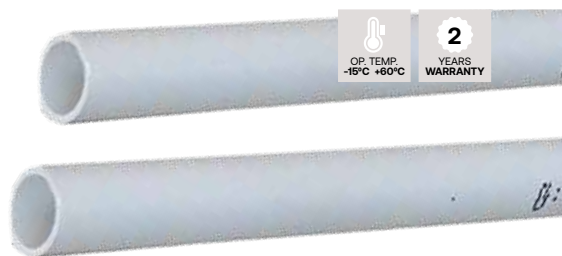

Code	Barcode	Type	Color / Ral	Dimensions(mm x m)	Packing	MOQ
151-21300	5206139633002	750N	GREY / 7035	Ø16	102m	102m
151-21301	5206139633019	750N	GREY / 7035	Ø20	102m	102m
151-21302	5206139633026	750N	GREY / 7035	Ø25	75m	75m
151-21303	5206139633033	750N	GREY / 7035	Ø32	51m	51m
151-21310	5207227334375	1250N	GREY / 7035	Ø16	102m	102m
151-21311	5207227334399	1250N	GREY / 7035	Ø20	102m	102m
151-21312	5207227334412	1250N	GREY / 7035	Ø25	75m	75m
151-21313	5207227334436	1250N	GREY / 7035	Ø32	51m	51m

## ΣΤΗΡΙΓΜΑΤΑ ΓΙΑ ΣΩΛΗΝΕΣ ΜΕΣΑΙΟΥ ΤΥΠΟΥ

### SADDLE CLIPS FOR CONDUITS

• Production Material PVC



Code	Barcode	Type	Color / Ral	Dimensions(mm)	Packing	MOQ
151-21400	5206139008862	750N-1250N	GREY / 7035	Ø16	100	100
151-21401	5206139008879	750N-1250N	GREY / 7035	Ø20	100	100
151-21402	5206139008886	750N-1250N	GREY / 7035	Ø25	50	50
151-21403	5207227075261	750N-1250N	GREY / 7035	Ø32	50	50

## ΓΩΝΙΕΣ ΓΙΑ ΣΩΛΗΝΕΣ

### BEND CURVES FOR CONDUITS

• Production Material PVC



Code	Barcode	Type	Color / Ral	Dimensions(mm)	Packing	MOQ
151-21410	5206139008893	750N-1250N	GREY / 7035	Ø16	1,50	20
151-21411	5206139008923	750N-1250N	GREY / 7035	Ø20	1,50	20
151-21412	5206139008961	750N-1250N	GREY / 7035	Ø25	1,50	20
151-21413	5207227075278	750N-1250N	GREY / 7035	Ø32	1,50	20

## ΜΟΥΦΕΣ ΓΙΑ ΣΩΛΗΝΕΣ ΜΕΣΑΙΟΥ ΤΥΠΟΥ

### COUPLERS FOR CONDUITS

• Production Material PVC



Code	Barcode	Type	Color / Ral	Dimensions(mm)	Packing	MOQ
151-21420	5206139008978	750N-1250N	GREY / 7035	Ø16	1,20	20
151-21421	5206139008985	750N-1250N	GREY / 7035	Ø20	1,20	20
151-21422	5206139008992	750N-1250N	GREY / 7035	Ø25	1,50	20
151-21423	5207227075285	750N-1250N	GREY / 7035	Ø32	1,20	20

### ΣΥΝΔΕΣΜΟΣ ΣΩΛΗΝΑΣ ΣΕ ΜΠΟΥΑΤ

#### ADAPTER FOR JUNCTION BOXES

• Production Material PVC

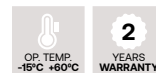

Code	Barcode	Color / Ral	Newton (N)	Dimensions(mm)	Packing	MOQ
151-21430	5207227334467	GREY / 7035	750N-1250N	Ø16	20	20
151-21431	5207227334481	GREY / 7035	750N-1250N	Ø20	20	20
151-21432	5207227334504	GREY / 7035	750N-1250N	Ø25	20	20
151-21433	5207227334528	GREY / 7035	750N-1250N	Ø32	20	20

### ΑΝΤΑΠΤΟΡΑΣ ΣΩΛΗΝΑΣ ΣΕ ΤΑΦ

#### T-SHAPE ADAPTER

• Production Material PVC



Code	Barcode	Color / Ral	Newton (N)	Dimensions(mm)	Packing	MOQ
151-21440	5207227334542	GREY / 7035	750N-1250N	Ø16	20	20
151-21441	5207227334566	GREY / 7035	750N-1250N	Ø20	20	20
151-21442	5207227334580	GREY / 7035	750N-1250N	Ø25	20	20
151-21443	5207227345050	GREY / 7035	750N-1250N	Ø32	20	20

### ΕΥΚΑΜΠΤΗ ΓΩΝΙΑ ΣΠΙΡΑΛ

#### FLEXIBLE BEND CURVE CONNECTOR

• Production Material PVC

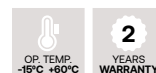

Code	Barcode	Color / Ral	Newton (N)	Dimensions(mm)	Packing	MOQ
151-21460	5207227568398	GREY / 7035	750-1250N	Ø16	20	20
151-21461	5207227568404	GREY / 7035	750-1250N	Ø20	20	20
151-21462	5207227568411	GREY / 7035	750-1250N	Ø25	20	20
151-21463	5207227568428	GREY / 7035	750-1250N	Ø32	20	20

## ΣΩΛΗΝΕΣ ΣΠΙΡΑΛ ΜΕΣΑΙΟΥ ΤΥΠΟΥ

### MEDIUM TYPE PLIABLE CONDUIT

• Production Material PVC

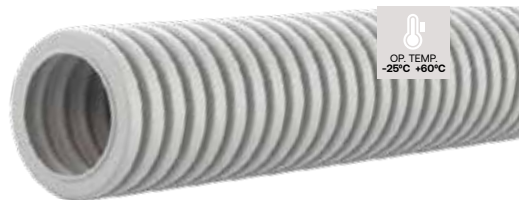

### ΑΝΤΟΧΗ ΣΤΗ ΔΙΑΔΟΣΗ ΦΛΟΓΑΣ

### RESISTANCE TO FIRE PROPAGATION

Code	Barcode	Color / Ral	Newton (N)	Dimensions(mm x m) outer diameter / inner diameter	Packing	MOQ
151-51310	5207227568435	GREY / 7035	750N	Ø16 / Ø11.2	100	100
151-51311	5207227568442	GREY / 7035	750N	Ø20 / Ø14.6	100	100
151-51312	5207227568459	GREY / 7035	750N	Ø25 / Ø18.6	100	100
151-51313	5207227568466	GREY / 7035	750N	Ø32 / Ø24.8	100	100
151-51314	5207227568473	GREY / 7035	750N	Ø40 / Ø31.2	100	100
151-51315	5207227568480	GREY / 7035	750N	Ø50 / Ø39.6	100	100
151-51316	5207227568497	GREY / 7035	750N	Ø63 / Ø52.5	100	100

\* Οι τιμές θα είναι διαθέσιμες κατόπιν αιτήματος παραγγελίας / Pricing will be provided upon order request

## ΣΩΛΗΝΕΣ ΣΠΙΡΑΛ ΒΑΡΕΩΣ ΤΥΠΟΥ

### HEAVY TYPE PLIABLE CONDUIT

• Production Material PVC



### ΑΝΤΟΧΗ ΣΤΗ ΔΙΑΔΟΣΗ ΦΛΟΓΑΣ

### RESISTANCE TO FIRE PROPAGATION

Code	Barcode	Color / Ral	Newton (N)	Dimensions(mm x m) outer diameter / inner diameter	Packing	MOQ
151-51320	5207227568503	GREY / 7035	1250N	Ø16 / Ø11.2	100	100
151-51321	5207227568510	GREY / 7035	1250N	Ø20 / Ø14.6	100	100
151-51322	5207227568527	GREY / 7035	1250N	Ø25 / Ø18.6	100	100
151-51323	5207227568541	GREY / 7035	1250N	Ø32 / Ø24.8	100	100

## ΣΩΛΗΝΑΣ ΣΠΙΡΑΛ ΕΛΑΦΡΟΥ ΤΥΠΟΥ ΜΕ ΟΔΗΓΟ

### LIGHT TYPE PLIABLE CONDUIT WITH CABLE PULLER

• Production Material PVC

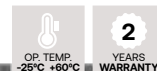

### ΑΝΤΟΧΗ ΣΤΗ ΔΙΑΔΟΣΗ ΦΛΟΓΑΣ

### RESISTANCE TO FIRE PROPAGATION

Code	Barcode	Color / Ral	Newton (N)	Dimensions(mm) outer diameter / inner diameter	Packing	MOQ
151-51370	5207227568695	BLACK/9004	450N	Ø16 / Ø11.2	100	100
151-51371	5207227568701	BLACK/9004	450N	Ø20 / Ø14.6	100	100
151-51372	5207227568718	BLACK/9004	450N	Ø25 / Ø18.6	100	100
151-51373	5207227568725	BLACK/9004	450N	Ø32 / Ø24.8	100	100

## ΑΝΤΑΠΤΟΡΑΣ ΣΩΛΗΝΑΣ ΣΠΙΡΑΛ ΣΕ ΜΠΟΥΑΤ

### ADAPTER FOR JUNCTION BOX

• Production Material PVC

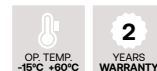

Code	Barcode	Color / Ral	Newton (N)	Dimensions(mm)	Packing	MOQ
151-21450	5207227568367	GREY / 7035	750-1250N	Ø16	20	20
151-21451	5207227568374	GREY / 7035	750-1250N	Ø20	20	20
151-21452	5207227568381	GREY / 7035	750-1250N	Ø25	20	20

## ΣΠΙΡΑΛ ΣΩΛΗΝΑΣ ΜΕΣΑΙΟΥ ΤΥΠΟΥ ΕΛΕΥΘΕΡΟΥ ΑΛΟΓΟΝΟΥ ΜΕ ΠΥΡΑΝΤΙΣΤΑΣΗ

MEDIUM TYPE PLIABLE CONDUIT HALOGEN FREE

• Production Material PE

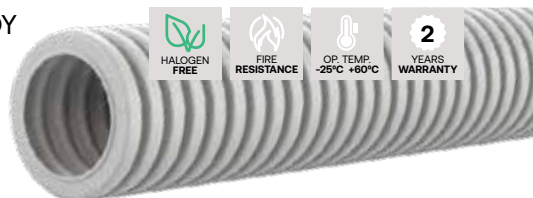

### ΑΝΤΟΧΗ ΣΤΗ ΔΙΑΔΟΣΗ ΦΛΟΓΑΣ RESISTANCE TO FIRE PROPAGATION

Code	Barcode	Color / Ral	Newton (N)	Dimensions(mm) outer diameter / inner diameter	Packing	MOQ
151-51340	5207227568534	GREY / 7035	750N	Ø16 / Ø11.2	50	50
151-51341	5207227568558	GREY / 7035	750N	Ø20 / Ø14.6	50	50
151-51342	5207227568565	GREY / 7035	750N	Ø25 / Ø18.6	50	50
151-51343	5207227568572	GREY / 7035	750N	Ø32 / Ø24.8	50	50
151-51344	5207227568589	GREY / 7035	750N	Ø40 / Ø31.2	50	50
151-51345	5207227568596	GREY / 7035	750N	Ø50 / Ø39.6	50	50
151-51346	5207227568602	GREY / 7035	750N	Ø63 / Ø52.5	50	50

\* Οι τιμές θα είναι διαθέσιμες κατόπιν αιτήματος παραγγελίας / Pricing will be provided upon order request

## ΣΠΙΡΑΛ ΣΩΛΗΝΑΣ ΒΑΡΕΩΣ ΤΥΠΟΥ ΕΛΕΥΘΕΡΟΥ ΑΛΟΓΟΝΟΥ ΜΕ ΠΥΡΑΝΤΙΣΤΑΣΗ

HEAVY TYPE PLIABLE CONDUIT HALOGEN FREE

• Production Material PE



### ΑΝΤΟΧΗ ΣΤΗ ΔΙΑΔΟΣΗ ΦΛΟΓΑΣ RESISTANCE TO FIRE PROPAGATION

Code	Barcode	Color / Ral	Newton (N)	Dimensions(mm) outer diameter / inner diameter	Packing	MOQ
151-51350	5207227568619	GREY / 7035	1250N	Ø16 / Ø11.2	50	50
151-51351	5207227568626	GREY / 7035	1250N	Ø20 / Ø14.6	50	50
151-51352	5207227568633	GREY / 7035	1250N	Ø25 / Ø18.6	50	50
151-51353	5207227568640	GREY / 7035	1250N	Ø32 / Ø24.8	50	50

\* Οι τιμές θα είναι διαθέσιμες κατόπιν αιτήματος παραγγελίας / Pricing will be provided upon order request

## ΣΩΛΗΝΑΣ ΣΠΙΡΑΛ ΕΛΑΦΡΟΥ ΤΥΠΟΥ ΕΛΕΥΘΕΡΟΥ ΑΛΟΓΟΝΟΥ LIGHT TYPE PLIABLE CONDUIT HALOGEN FREE

• Production Material PE

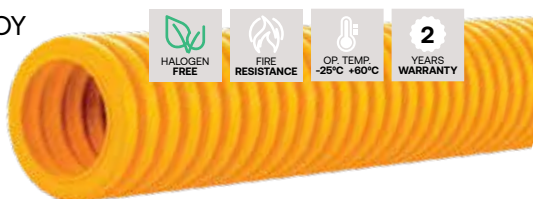

### ΑΝΤΟΧΗ ΣΤΗ ΔΙΑΔΟΣΗ ΦΛΟΓΑΣ RESISTANCE TO FIRE PROPAGATION

Code	Barcode	Color / Ral	Newton (N)	Dimensions(mm) outer diameter / inner diameter	Packing	MOQ
151-51360	5207227568657	YELLOW/1023	320N	Ø16 / Ø11.2	50	50
151-51361	5207227568664	YELLOW/1023	320N	Ø20 / Ø14.6	50	50
151-51362	5207227568671	YELLOW/1023	320N	Ø25 / Ø18.6	50	50
151-51363	5207227568688	YELLOW/1023	320N	Ø32 / Ø24.8	50	50

## ΣΩΛΗΝΕΣ ΣΠΙΡΑΛ ΕΛΑΦΡΟΥ ΤΥΠΟΥ

### LIGHT TYPE PLIABLE CONDUIT



Code	Barcode	Color / Ral	Newton (N)	Dimensions(mm x m)	Packing	MOQ
151-51000	5206139620002	GREY / 9003	320N	Ø11	50m	50
151-51010	5206139620101	GREY / 9003	320N	Ø13.5	50m	50
151-51020	5206139620200	GREY / 9003	320N	Ø16	50m	50
151-51030	5206139620309	GREY / 9003	320N	Ø23	50m	50

## ΣΩΛΗΝΕΣ ΜΠΕΤΟΥ

### MEDIUM TYPE PLIABLE CONDUIT FOR CONCRETE



Code	Barcode	Color / Ral	Newton (N)	Dimensions(mm x m)	Packing	MOQ
151-51109	5206139621092	GREY / 7046	750N	Ø11	50m	50
151-51100	5206139621009	GREY / 7046	750N	Ø13.5	50m	50
151-51101	5206139621016	GREY / 7046	750N	Ø16	50m	50
151-51102	5206139621023	GREY / 7046	750N	Ø23	50m	50

## ΣΩΛΗΝΕΣ ΧΕΛΙΦΛΕΞ

### PLIABLE CONDUIT HELIFLEX



Code	Barcode	Color	Dimensions(mm x m)	Packing	MOQ
151-21801	5206139638014	GREY	Ø12	25m	25
151-21802	5206139638021	GREY	Ø14	25m	25
151-21803	5206139638038	GREY	Ø16	25m	25
151-21804	5206139638045	GREY	Ø18	25m	25
151-21805	5206139638052	GREY	Ø20	25m	25
151-21806	5206139638069	GREY	Ø22	25m	25
151-21807	5206139638076	GREY	Ø25	25m	25
151-21808	5206139638083	GREY	Ø28	25m	25
151-21810	5206139638106	GREY	Ø32	25m	25
151-21812	5207227033131	GREY	Ø38	25m	25
151-21813	5207227033148	GREY	Ø40	25m	25
151-21815	5206139009098	WHITE	Ø16	25m	25
151-21816	5206139009104	WHITE	Ø18	25m	25
151-21817	5207227033155	WHITE	Ø20	25m	25

ΑΞΕΣΟΥΑΡ  
ΚΑΛΩΔΙΩΝ  
CABLE ACCESSORIES

ΤΗΛΕΦΩΝΟΥ  
TELEPHONE

ΤΗΛΕΟΡΑΣΗΣ  
TV



## ΦΙΣ ΤΗΛΕΦΩΝΟΥ Α.Τ. MODULAR TELEPHONE UTP CONNECTORS

- Voltage <36V 50/60Hz
- Production Material Copper & Plastic



Code	Barcode	Description	Packing	MOQ
147-10051	5206139107015	4P2C ΑΚΟΥΣΤΙΚΟΥ / HEADSET	100/1000/25000	100
147-10052	5206139107022	6P4C ΓΡΑΜΜΗΣ / LINE	100/20000	100
147-10053	5206139107039	UTP Cat.5 8P8C / DATA	100/10000	100
147-10050	5206139107008	UTP Cat.6e 8P8C / DATA	100/1000/10000	100
147-10060	5207227257513	UTP Cat.6 8P8C / DATA	100/10000	100
147-10061	5207227257544	UTP Cat.7 8P8C / DATA	100/10000	100

## ΑΝΤΑΠΤΟΡΕΣ ΤΗΛΕΦΩΝΟΥ & ΣΥΝΔΕΣΜΟΙ TELEPHONE ADAPTORS & CONNECTORS

- Voltage <36V 50/60Hz
- Production Material Copper & Plastic



Code	Barcode	Description	Packing	MOQ
147-10054	5206139107046	ΕΝΩΤΙΚΟΣ ΣΥΝΔΕΣΜΟΣ Α.Τ. 6P4C Rj11 MODULAR CORD COUPLE 6P4C Rj11	1/100/1000	10
147-10055	5206139107053	ΑΝΤΑΠΤ. ΑΡΣΕΝΙΚΟ ΣΕ 2 ΘΗΛΥΚΑ 6P4C Rj11 ADAPTOR PLUG MALE TO 2 FEMALE 6P4C Rj11	1/100/1000	10
147-10056	5206139107060	ΑΝΤΑΠΤ. ΑΡΣΕΝΙΚΟ ΣΕ 3 ΘΗΛΥΚΑ 6P4C Rj11 ADAPTOR PLUG MALE TO 3 FEMALE 6P4C Rj11	1/100/1000	10
147-10057	5206139107077	ΑΝΤΑΠΤ. ΑΡΣΕΝΙΚΟ ΣΕ 5 ΘΗΛΥΚΑ 6P4C Rj11 ADAPTOR PLUG MALE TO 5 FEMALE 6P4C Rj11	1/200	10
147-10059	5206139107091	ΑΝΤΑΠΤ. ΘΗΛΥΚΟ ΣΕ 2 ΘΗΛΥΚΑ Α.Τ. 6P4C Rj11 ADAPTOR FEMALE TO 2 FEMALE 6P4C Rj11	1/100/1000	10
147-10091	5206139107404	ΕΝΩΤΙΚΟΣ ΣΥΝΔΕΣΜΟΣ ΔΙΚΤΥΟΥ Α.Τ. 8P8C Rj45 MODULAR CORD COUPLER A.T. 8P8C Rj45	1/100/1000	5

## ΠΡΙΖΕΣ ΤΗΛΕΦΩΝΟΥ TELEPHONE SOCKETS • DATA

- Voltage <36V 50/60Hz
- Production Material Copper & Plastic



Code	Barcode	Description	Packing	MOQ
147-16050	5206139107398	ΜΟΝΗ ΑΥΤΟΚΟΛΛΗΤΗ 6P4C RJ11 / SINGLE ADHESIVE 6P4C RJ11	1/500	10
147-16051	5206139107411	ΔΙΠΛΗ ΑΥΤΟΚΟΛΛΗΤΗ 6P4C Rj11 / DOUBLE ADHESIVE 6P4C Rj11	1/500	10
147-16052	5207227016141	ΜΟΝΗ ΑΥΤΟΚΟΛΛΗΤΗ RG45 CAT-5e / SINGLE ADHESIVE RG45 CAT-5e	1/500	10
147-16053	5207227016172	ΔΙΠΛΗ ΑΥΤΟΚΟΛΛΗΤΗ RG45 CAT-5e / DOUBLE ADHESIVE RG45 CAT-5e	1/250	10
147-16054	5207227016158	ΜΟΝΗ ΑΥΤΟΚΟΛΛΗΤΗ RG45 CAT-6e / SINGLE ADHESIVE RG45 CAT-6e	1/250	10
147-16055	5207227016202	ΔΙΠΛΗ ΑΥΤΟΚΟΛΛΗΤΗ RG45 CAT-6e / DOUBLE ADHESIVE RG45 CAT-6e	1/250	10
147-16056	5207227257575	ΜΟΝΗ ΑΥΤΟΚΟΛΛΗΤΗ RG45 CAT-6A / SINGLE ADHESIVE RG45 CAT-6A	1/250	10
147-16057	5207227257599	ΔΙΠΛΗ ΑΥΤΟΚΟΛΛΗΤΗ RG45 CAT-6A / DOUBLE ADHESIVE RG45 CAT-6A	1/250	10
147-16058	5207227257612	ΜΟΝΗ ΑΥΤΟΚΟΛΛΗΤΗ RG45 CAT-7e / SINGLE ADHESIVE RG45 CAT-7e	1/250	10
147-16059	5207227257636	ΔΙΠΛΗ ΑΥΤΟΚΟΛΛΗΤΗ RG45 CAT-7e / DOUBLE ADHESIVE RG45 CAT-7e	1/250	10

## ΦΙΛΤΡΟ ΓΡΑΜΜΗΣ ADSL & SPLITTER TELEPHONE FILTER ADSL & SPLITTER

• Voltage <36V 50/60Hz • Production Material Copper & Plastic



Code	Barcode	Description	Packing	MOQ
147-16021	5206139091260	ΦΙΛΤΡΟ ΓΡΑΜΜΗΣ ADSL & SPLITTER / TELEPHONE FILTER ADSL & SPLITTER	1/10/500	4

## ΠΡΟΕΚΤΑΣΕΙΣ ΤΗΛΕΦΩΝΟΥ EXTENSION TELEPHONE CORDS

• Voltage <36V 50/60Hz • Production Material Copper & Plastic



Code	Barcode	Color	Description	Length(m)	Packing	MOQ
147-10062	5206139107121	WHITE	6P4C RJ11	3	1/250	5
147-10063	5206139107138	WHITE	6P4C RJ11	5	1/200	5
147-10070	5206139107183	BLACK	6P4C RJ11	3	1/10/200	5
147-10074	5206139107244	WHITE	6P4C RJ11	10	1/10/1930	5

## ΣΠΙΡΑΛ ΤΗΛΕΦΩΝΟΥ TELEPHONE SPIRAL

• Voltage <36V 50/60Hz • Production Material Copper & Plastic



Code	Barcode	Color	Description	Length(m)	Packing	MOQ
147-10064	5206139107145	WHITE	4P4C Rj11	2	1/200	5
147-10065	5206139107152	WHITE	4P4C Rj11	4	1/200	5
147-10066	5206139107169	BLACK	4P4C Rj11	2	1/200	5
147-10069	5206139107206	BLACK	4P4C Rj11	4	1/10/200	5

## ΚΑΛΩΔΙΑ ΤΗΛΕΦΩΝΟΥ ΠΛΑΚΕ 2 ΖΕΥΓΩΝ FLAT TELEPHONE CABLES 2 PAIR

• Voltage <36V  
• Production Material Copper & Plastic



Code	Barcode	Color	Description	Length(m)	Packing	MOQ
147-13100	5206139200006	WHITE	Rj11	100	100/1000	100
147-13110	5206139200013	BLACK	Rj11	100	100/1000	100

## ΠΡΟΕΚΤΑΣΕΙΣ ΔΙΚΤΥΟΥ UTP CAT.5E PATCH CORDS UTP CAT.5E

• Production Material Copper & Plastic



Code	Barcode	Color	Length(m)	Packing	MOQ
147-10150	5206139107503	GREY	1	1/200	5
147-10151	5206139107510	GREY	2	1/200	5
147-10152	5206139107527	GREY	3	1/100	5
147-10153	5206139107534	GREY	5	1/100	5
147-10154	5206139107541	GREY	10	1/50	5
147-10155	5207227016301	GREY	15	1/30	1

## ΠΡΟΕΚΤΑΣΕΙΣ ΔΙΚΤΥΟΥ UTP CAT.6E PATCH CORDS UTP CAT.6E

• Production Material Copper & Plastic



Code	Barcode	Color	Length(m)	Packing	MOQ
147-10170	5207227016325	GREY	0.5	1/200	5
147-10171	5207227016349	GREY	1	1/200	5
147-10172	5207227016363	GREY	2	1/200	5
147-10173	5207227016387	GREY	3	1/100	5
147-10174	5207227016400	GREY	5	1/100	5
147-10175	5207227016424	GREY	10	1/50	1
147-10176	5207227016448	GREY	15	1/51	1
147-10177	5207227106200	GREY	20	1/20	1
147-10178	5207227106217	GREY	30	1/20	1
147-10179	5207227106224	GREY	50	1/20	1

## ΟΡΙΟΛΩΡΙΔΕΣ DISCONNECTION MODULES

• Production Material Copper & Plastic



Code	Barcode	Description	Packing	MOQ
147-02100	5206139221001	ΟΡΙΟΛΩΡΙΔΑ 10 ΖΕΥΓΩΝ / 10 PAIRS DISCONNECTION MODULE	10/500	10

## ΠΡΕΣΣΕΣ ΤΗΛΕΦΩΝΟΥ CRIMPING TELEPHONE TOOLS

• Production Material Copper & Plastic



Code	Barcode	Description	Packing	MOQ
147-10068	5206139107190	ΜΕΤΑΛΛΙΚΗ / METALLIC - 8P8C	1/10/100	1
147-10071	5206139107213	ΜΕΤΑΛΛΙΚΗ / METALLIC - 8P6C	1/10/200	1

## ΦΙΣ TV ΠΛΑΓΙΑΣ TV ANGLE CONNECTOR

• Production Material Metallic & Plastic



Code	Barcode	Description	Packing	MOQ
147-10104	5206139104045	ΦΙΣ TV ΑΡΣΕΝΙΚΟ ΠΛΑΓΙΑΣ / PLUG TV MALE RIGHT ANGLE	25/2000	25
147-10105	5206139104052	ΦΙΣ TV ΘΗΛΥΚΟ ΠΛΑΓΙΑΣ / PLUG TV FEMALE RIGHT ANGLE	25/2000	25

## ΤΑΦ TV T-SHAPE TV ADAPTER

• Production Material Metallic & Plastic



Code	Barcode	Description	Packing	MOQ
147-10102	5206139104021	ΤΑΦ TV ΑΡΣΕΝΙΚΟ / ADAPTOR TV MALE	1/100/200	25
147-10103	5206139104038	ΤΑΦ TV ΘΗΛΥΚΟ / ADAPTOR TV FEMALE	1/100/200	25

## ΦΙΣ TV TV PLUG

• Production Material Metallic & Plastic



Code	Barcode	Description	Packing	MOQ
147-10100	5206139104007	ΦΙΣ TV ΑΡΣΕΝΙΚΟ / TV PLUG MALE	1/100/2000	25
147-10101	5206139104014	ΦΙΣ TV ΘΗΛΥΚΟ / TV PLUG FEMALE	1/100/2000	25

## ΦΙΣ F F PLUG

• Production Material Metallic



Code	Barcode	Description	Packing	MOQ
147-10106	5206139104069	ΦΙΣ ΜΕΤΑΛΛΙΚΟΥ ΤΥΠΟΥ F / PLUG METALLIC F TYPE MALE	1/100/5000	25
147-10107	5207227033209	ΕΝΩΤΙΚΟ ΦΙΣ ΤΥΠΟΥ F / PLUG CONNECTOR ZINC F TYPE	1/100/5000	25

## ΠΡΟΕΚΤΑΣΗ TV 1.5M TV EXTENSION CABLE

• Production Material Copper & Plastic



Code	Barcode	Color	Length(m)	Packing	MOQ
147-13126	5206139200266	WHITE	1.5	10/300	5
147-13127	5206139200273	WHITE	3	10/150	5
147-13128	5207227016516	BLACK	1.5	10/250	5
147-13129	5207227016530	BLACK	3	10/150	5

## ΔΙΑΚΛΑΔΩΤΗΣ TV 2 WAY TV SPLITTER

- Production Material Metallic



Code	Barcode	Description	Length(mm)	Packing	MOQ
147-10120	5207227033230	2 WAY - F 1/2	53	5/250	5
147-10121	5207227033261	3 WAY - F 1/3	72	5/200	5
147-10122	5207227033292	4 WAY - F 1/4	72	5/200	5
147-10123	5207227033322	6 WAY - F 1/6	116	5/100	5
147-10124	5207227033353	8 WAY - F 1/8	116	5/100	5

## ΜΙΚΤΗΣ TV - SAT SATELLITE COMBINER TV-SAT

- Production Material Metallic



Code	Barcode	Description	Length(mm)	Packing	MOQ
147-10125	5207227033384	TV-SAT TYPE F	59	5/250	5

## ΚΑΛΩΔΙΑ ΣΥΝΔΕΣΗΣ HDMI HDMI CABLES

- Production Material Copper & Plastic
- 10.2 Gbps ETHERNET SPEED
- HDMI cable 1-3m: Supports devices with maximum resolution: 2160p
- HDMI cable 5-10m: Supports devices with maximum resolution: 1080p



Code	Barcode	Color	Length(m)	Packing	MOQ
147-10140	5206139101402	BLACK	1	1/150	5
147-10141	5206139101419	BLACK	2	1/110	5
147-10142	5206139101426	BLACK	3	1/100	5
147-10143	5206139101433	BLACK	4	1/50	5
147-10144	5206139101440	BLACK	10	1/50	1

## SCART ΣΕ SCART SCART TO SCART

- Production Material Copper & Plastic



Code	Barcode	Color	Length(m)	Packing	MOQ
147-10110	5206139104106	BLACK	1.5	1/100	5

# ΠΙΝΑΚΕΣ DIN RAIL ENCLOSURES

ΒΙΟΜΗΧΑΝΙΚΑ ΚΟΥΤΙΑ  
INDUSTRIAL BOXES

ΠΛΑΣΤΙΚΑ ΦΡΕΑΤΙΑ  
PLASTIC MANHOLE

ΜΠΟΥΑΤ  
JUNCTION BOXES



**ΠΙΝΑΚΕΣ ΧΩΝΕΥΤΟΙ**  
RECESSED ENCLOSURES

• Production Material Metallic & Plastic IEC 60670-1 & IEC 60670-24



Code	Barcode	Description	Color	Dimensions(mm)		Packing	MOQ
				external product dimensions (abc*)	installation hole dimensions (xyz)		
WHITE BODY & WHITE DOOR / PLASTIC							
147-31220	5207227596186	1X12+2 ΘΕΣΕΩΝ	ΛΕΥΚΟ / WHITE	368 x 343 x 93	314 x 314 x 86,5	1/10	1
147-31221	5207227596193	2X12+4 ΘΕΣΕΩΝ	ΛΕΥΚΟ / WHITE	368 x 568 x 93	314 x 539 x 86,5	1/10	1
147-31222	5207227596209	3X12+6 ΘΕΣΕΩΝ	ΛΕΥΚΟ / WHITE	368 x 878 x 93	314 x 849 x 86,5	1/10	1
WHITE BODY & FUME DOOR / PLASTIC							
147-31210	5207227573132	1X12+2 ΘΕΣΕΩΝ	ΓΚΡΙ-ΛΕΥΚΟ / FUME-WHITE	368 x 343 x 93	314 x 314 x 86,5	1/10	1
147-31211	5207227573149	2X12+4 ΘΕΣΕΩΝ	ΓΚΡΙ-ΛΕΥΚΟ / FUME-WHITE	368 x 568 x 93	314 x 539 x 86,5	1/10	1
147-31212	5207227573156	3X12+6 ΘΕΣΕΩΝ	ΓΚΡΙ-ΛΕΥΚΟ / FUME-WHITE	368 x 878 x 93	314 x 849 x 86,5	1/10	1

\* c - depth

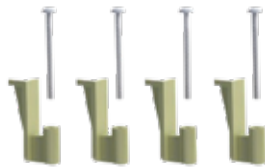

**147-31230**  
ΣΤΗΡΙΓΜΑΤΑ ΓΙΑ ΓΥΨΟΣΑΝΙΔΑ  
PLASTER WALL FRAMING SUPPORTS



**ΠΙΝΑΚΕΣ ΧΩΝΕΥΤΟΙ ΜΕ ΜΕΤΑΛΛΙΚΗ ΠΟΡΤΑ**  
**RECESSED ENCLOSURES WITH METALLIC DOOR**

• Production Material Metallic IEC 60670-1 & IEC 60670-24



Code	Barcode	Description	Dimensions(mm)		Packing	MOQ
			external product dimensions (abc*)	installation hole dimensions (xyz)		
147-31200	5207227493393	1X12+2 ΘΕΣΕΩΝ	368 x 343 x 93	314 x 314 x 86,5	1	1
147-31201	5207227493409	2X12+4 ΘΕΣΕΩΝ	368 x 443 x 93	314 x 414 x 86,5	1	1
147-31202	5207227493416	3X12+6 ΘΕΣΕΩΝ	368 x 568 x 93	314 x 539 x 86,5	1	1
147-31203	5207227493423	4X12+8 ΘΕΣΕΩΝ	368 x 753 x 93	314 x 724 x 86,5	1	1
147-31204	5207227493430	5X12+10 ΘΕΣΕΩΝ	368 x 878 x 93	314 x 849 x 86,5	1	1

\* c - depth

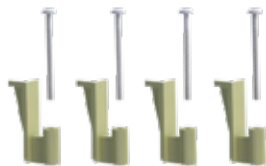

**147-31230**  
**ΣΤΗΡΙΓΜΑΤΑ ΓΙΑ ΓΥΨΟΣΑΝΙΔΑ**  
**PLASTER WALL FRAMING SUPPORTS**



**ΠΙΝΑΚΕΣ ΕΞΩΤΕΡΙΚΟΙ ΧΩΡΙΣ ΠΟΡΤΑ**  
SURFACE MOUNT ENCLOSURES WITHOUT DOOR

• Production Material Plastic



147-31023



147-31024



Code	Barcode	Description	Dimensions(mm)	Packing	MOQ
147-31023	5206139022905	1-2 ΘΕΣΕΩΝ / 1-2M	50x125x60	1/20	10
147-31024	5206139022929	2-4 ΘΕΣΕΩΝ / 2-4M	85x125x60	1/32	10



← ΠΙΕΣΤΕ ΤΟ ΣΗΜΕΙΟ "OPEN" ΓΙΑ ΝΑ ΑΝΟΙΞΕΙ Ο ΠΙΝΑΚΑΣ  
PRESS THE "OPEN" BUTTON TO OPEN THE PANEL

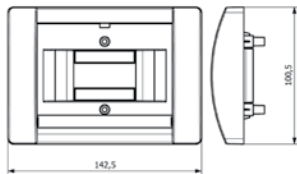

NEW

**ΠΙΝΑΚΑΣ ΕΞΩΤΕΡΙΚΟΣ 2 ΘΕΣΕΩΝ ΜΕ ΠΟΡΤΑ**  
2-MODULE SURFACED ENCLOSURE WITH DOOR

• Production Material Plastic



Code	Dimensions (HxWxD mm)	Color / Ral	Weight(kg)	Packing	MOQ
147-31030	143x100x98	WHITE / 9010	0.1875	1/60	1

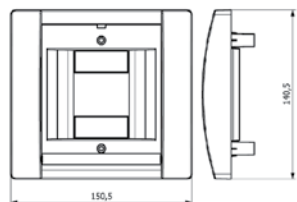

NEW

**ΠΙΝΑΚΑΣ ΕΞΩΤΕΡΙΚΟΣ 4 ΘΕΣΕΩΝ ΜΕ ΠΟΡΤΑ**  
4-MODULE SURFACED ENCLOSURE WITH DOOR

• Production Material Plastic



Code	Dimensions (HxWxD mm)	Color / Ral	Weight(kg)	Packing	MOQ
147-31031	150x140x97.5	WHITE / 9010	0.325	1/45	1

NEW

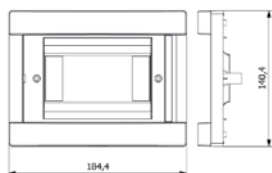

**ΠΙΝΑΚΑΣ ΕΞΩΤΕΡΙΚΟΣ 6 ΘΕΣΕΩΝ ΜΕ ΠΟΡΤΑ**  
6-MODULE SURFACED ENCLOSURE WITH DOOR



• Production Material Plastic

Code	Dimensions (HxWxD mm)	Color / Ral	Weight(kg)	Packing	MOQ
147-31032	140x184x99.5	WHITE / 9010	0.373	1/30	1

NEW

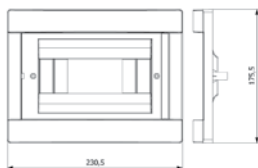

**ΠΙΝΑΚΑΣ ΕΞΩΤΕΡΙΚΟΣ 8 ΘΕΣΕΩΝ ΜΕ ΠΟΡΤΑ**  
8-MODULE SURFACED ENCLOSURE WITH DOOR



• Production Material Plastic

Code	Dimensions (HxWxD mm)	Color / Ral	Weight(kg)	Packing	MOQ
147-31033	176x231x100	WHITE / 9010	0.520	1/20	1

NEW

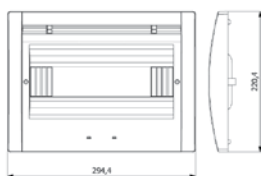

**ΠΙΝΑΚΑΣ ΕΞΩΤΕΡΙΚΟΣ 12 ΘΕΣΕΩΝ ΜΕ ΠΟΡΤΑ**  
12-MODULE SURFACED ENCLOSURE WITH DOOR



• Production Material Plastic

Code	Dimensions (HxWxD mm)	Color / Ral	Weight(kg)	Packing	MOQ
147-31034	221x295x100	WHITE / 9010	0.770	1/20	1

NEW

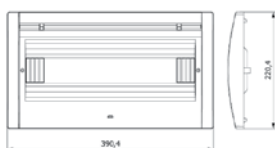

**ΠΙΝΑΚΑΣ ΕΞΩΤΕΡΙΚΟΣ 18 ΘΕΣΕΩΝ ΜΕ ΠΟΡΤΑ**  
18-MODULE SURFACED ENCLOSURE WITH DOOR



• Production Material Plastic

Code	Dimensions (HxWxD mm)	Color / Ral	Weight(kg)	Packing	MOQ
147-31035	220x390x103	WHITE / 9010	1.060	1/10	1

NEW

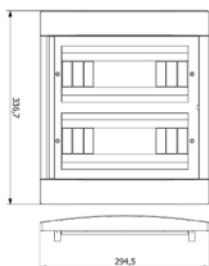

**ΠΙΝΑΚΑΣ ΕΞΩΤΕΡΙΚΟΣ 24 ΘΕΣΕΩΝ ΜΕ ΠΟΡΤΑ**  
24-MODULE SURFACED ENCLOSURE WITH DOOR



• Production Material Plastic

Code	Dimensions (HxWxD mm)	Color / Ral	Weight(kg)	Packing	MOQ
147-31036	337x295x100	WHITE / 9010	1.270	1/10	1

NEW



**ΠΙΝΑΚΑΣ ΕΞΩΤΕΡΙΚΟΣ 36 ΘΕΣΕΩΝ ΜΕ ΠΟΡΤΑ**  
36-MODULE SURFACED ENCLOSURE WITH DOOR



• Production Material Plastic

Code	Dimensions (HxWxD mm)	Color / Ral	Weight(kg)	Packing	MOQ
147-31037	453x295x100	WHITE / 9010	1.630	1/10	1



← ΠΙΕΣΤΕ ΤΟ ΣΗΜΕΙΟ "OPEN" ΓΙΑ ΝΑ ΑΝΟΙΞΕΙ Ο ΠΙΝΑΚΑΣ  
PRESS THE "OPEN" BUTTON TO OPEN THE PANEL

NEW

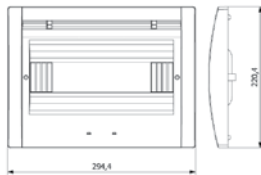

**ΠΙΝΑΚΑΣ ΧΩΝΕΥΤΟΣ 12 ΘΕΣΕΩΝ ΜΕ ΠΟΡΤΑ**  
12-MODULE RECESSED ENCLOSURE WITH DOOR

• Production Material ABS



Code	Dimensions (mm) height x width x depth	Color / Ral body / cover	Weight(kg)	Packing	MOQ
147-31040	215x284x100	RED 2001 WHITE 9010	0.770	1/20	1

NEW

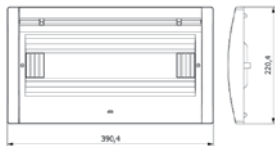

**ΠΙΝΑΚΑΣ ΧΩΝΕΥΤΟΣ 18 ΘΕΣΕΩΝ ΜΕ ΠΟΡΤΑ**  
18-MODULE RECESSED ENCLOSURE WITH DOOR

• Production Material ABS



Code	Dimensions (mm) height x width x depth	Color / Ral body / cover	Weight(kg)	Packing	MOQ
147-31041	212x365x100	RED 2001 WHITE 9010	0.950	1/10	1

NEW



**ΠΙΝΑΚΑΣ ΧΩΝΕΥΤΟΣ 24 ΘΕΣΕΩΝ ΜΕ ΠΟΡΤΑ**  
24-MODULE RECESSED ENCLOSURE WITH DOOR

• Production Material ABS



Code	Dimensions (mm) height x width x depth	Color / Ral body / cover	Weight(kg)	Packing	MOQ
147-31042	320x284x100	RED 2001 WHITE 9010	1.140	1/10	1

NEW



**ΠΙΝΑΚΑΣ ΧΩΝΕΥΤΟΣ 36 ΘΕΣΕΩΝ ΜΕ ΠΟΡΤΑ**  
36-MODULE RECESSED ENCLOSURE WITH DOOR

• Production Material ABS



Code	Dimensions (mm) height x width x depth	Color / Ral body / cover	Weight(kg)	Packing	MOQ
147-31043	446x284x100	RED 2001 WHITE 9010	1.560	1/10	1



## ΡΑΓΑ ΑΣΦΑΛΕΙΩΝ DIN MOUNTING RAIL

- Production Material Iron



Code	Barcode	Description	Dimensions(m/mm)	Packing	MOQ
147-08010	5207227022722	ΜΠΑΡΑ ΑΣΦΑΛΕΙΩΝ 1Μ ΩΜΕΓΑ OMEGA DIN MOUNTING RAIL	1x35x7,5	1/20/100	1

ΠΙΝΑΚΑΣ ΧΩΝΕΥΤΟΣ ΜΕΤΑΛΛΙΚΟΣ  
RECESSED METAL DIN RAIL ENCLOSURES



147-31120

147-31121

147-31122

147-31123

147-31124

147-31125

147-31126

Code	Barcode	Description	Dimensions (cm) height x width x depth	Packing	MOQ
147-31120	5207227431258	1-16 ΘΕΣΕΩΝ / 1-16Μ	33x44x11	1	1
147-31121	5207227431265	2-16 ΘΕΣΕΩΝ / 2-16Μ	50x44x11	1	1
147-31122	5207227431272	3-16 ΘΕΣΕΩΝ / 3-16Μ	66x44x11	1	1
147-31123	5207227431289	4-16 ΘΕΣΕΩΝ / 4-16Μ	80x44x11	1	1
147-31124	5207227431296	5-16 ΘΕΣΕΩΝ / 5-16Μ	95x44x11	1	1
147-31125	5207227431302	6-16 ΘΕΣΕΩΝ /6-16Μ	110x44x11	1	1
147-31126	5207227431319	7-16 ΘΕΣΕΩΝ / 7-16Μ	125x44x11	1	1

ΠΙΝΑΚΑΣ ΧΩΝΕΥΤΟΣ ΜΕΤΑΛΛΙΚΟΣ  
RECESSED METAL DIN RAIL ENCLOSURES



147-31130

147-31131

147-31132

147-31133

147-31134

147-31136

147-31135

Code	Barcode	Description	Dimensions (cm) height x width x depth	Packing	MOQ
147-31130	5207227431326	1-24 ΘΕΣΕΩΝ / 1-24Μ	36x58x10	1	1
147-31131	5207227431333	2-24 ΘΕΣΕΩΝ / 2-24Μ	50x58x10	1	1
147-31132	5207227431340	3-24 ΘΕΣΕΩΝ / 3-24Μ	65x58x10	1	1
147-31133	5207227431357	4-24 ΘΕΣΕΩΝ / 4-24Μ	80x58x10	1	1
147-31134	5207227431364	5-24 ΘΕΣΕΩΝ / 5-24Μ	95x58x10	1	1
147-31135	5207227431371	6-24 ΘΕΣΕΩΝ /6-24Μ	110x58x10	1	1
147-31136	5207227431388	7-24 ΘΕΣΕΩΝ / 7-24Μ	125x58x10	1	1

ΠΙΝΑΚΑΣ ΕΞΩΤΕΡΙΚΟΣ ΜΕΤΑΛΛΙΚΟΣ  
SURFACED METAL DIN RAIL ENCLOSURES



147-31140

147-31141

147-31142

147-31143

147-31144

147-31145

147-31146

Code	Barcode	Description	Dimensions (cm) height x width x depth	Packing	MOQ
147-31140	5207227431395	1-24 ΘΕΣΕΩΝ / 1-24Μ	29x55x13	1	1
147-31141	5207227431401	2-24 ΘΕΣΕΩΝ / 2-24Μ	45x55x13	1	1
147-31142	5207227431418	3-24 ΘΕΣΕΩΝ / 3-24Μ	60x55x13	1	1
147-31143	5207227431425	4-24 ΘΕΣΕΩΝ / 4-24Μ	75x55x13	1	1
147-31144	5207227431432	5-24 ΘΕΣΕΩΝ / 5-24Μ	90x55x13	1	1
147-31145	5207227431449	6-24 ΘΕΣΕΩΝ /6-24Μ	115x55x13	1	1
147-31146	5207227431456	7-16 ΘΕΣΕΩΝ / 7-16Μ	119x55x13	1	1



ΠΟΛΥΚΑΡΒΟΥΝΙΚΑ ΒΙΟΜΗΧΑΝΙΚΑ ΚΙΒΩΤΙΑ ΚΕΝΑ  
INDUSTRIAL POLYCARBONATE EMPTY BOXES



Code	Barcode	Dimensions(mm)	Color / Ral	Packing	MOQ
147-31400	5207227573163	200x300x130	GREY / 7035	1	1
147-31401	5207227573170	250x350x150	GREY / 7035	1	1
147-31402	5207227573187	300x400x170	GREY / 7035	1	1
147-31403	5207227573194	300x400x220	GREY / 7035	1	1
147-31404	5207227573200	350x500x190	GREY / 7035	1	1
147-31405	5207227573217	400x500x180	GREY / 7035	1	1
147-31406	5207227573224	400x500x240	GREY / 7035	1	1
147-31407	5207227573231	400x600x200	GREY / 7035	1	1
147-31408	5207227573248	500x700x250	GREY / 7035	1	1
147-31409	5207227573255	600x800x260	GREY / 7035	1	1

ΠΟΛΥΚΑΡΒΟΥΝΙΚΑ ΒΙΟΜΗΧΑΝΙΚΑ ΚΙΒΩΤΙΑ ΚΕΝΑ ΜΕ ΔΙΑΦΑΝΗ ΠΟΡΤΑ  
INDUSTRIAL POLYCARBONATE EMPTY BOXES WITH TRANSPARENT DOOR



Code	Barcode	Dimensions(mm)	Color / Ral	Packing	MOQ
147-31410	5207227573262	200x300x130	GREY / 7035	1	1
147-31411	5207227573279	250x350x150	GREY / 7035	1	1
147-31412	5207227573286	300x400x170	GREY / 7035	1	1
147-31413	5207227573293	300x400x220	GREY / 7035	1	1
147-31414	5207227573309	350x500x190	GREY / 7035	1	1
147-31415	5207227573316	400x500x180	GREY / 7035	1	1
147-31416	5207227573323	400x500x240	GREY / 7035	1	1
147-31417	5207227573330	400x600x200	GREY / 7035	1	1
147-31418	5207227573347	500x700x250	GREY / 7035	1	1
147-31419	5207227573354	600x800x260	GREY / 7035	1	1

## ΜΕΤΩΠΗ ΗΛΕΚΤΡΟΛΟΓΙΚΟΥ ΠΙΝΑΚΑ ΠΟΛΥΚΑΡΒΟΥΝΙΚΟΥ ΚΙΒΩΤΙΟΥ FRONT FRAMES WITH DIN RAILS FOR POLYCARBONATE ENCLOSURES

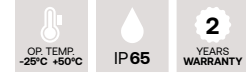

NEW



Code	Barcodes	Description	Combined with	Dimensions(mm)	Packing	MOQ
147-31420	5207227573361	(2x8) 16 ΘΕΣΕΩΝ / 16M	147-31401 / 147-31411	250x350x150	1	1
147-31421	5207227573378	(2x12) 24 ΘΕΣΕΩΝ / 24M	147-31402 / 147-31412	300x400x170	1	1
147-31422	5207227573385	(3x14) 42 ΘΕΣΕΩΝ / 42M	147-31404 / 147-31413	350x500x190	1	1
147-31423	5207227573392	(4x17) 68 ΘΕΣΕΩΝ 68M	147-31407 / 147-31414	400x600x200	1	1

## ΜΕΤΑΛΛΙΚΗ ΠΛΑΤΗ ΠΟΛΥΚΑΡΒΟΥΝΙΚΟΥ ΚΙΒΩΤΙΟΥ GALVANIZED SHEET FOR POLYCARBONATE ENCLOSURES

NEW

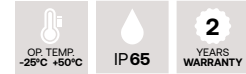

Code	Description	Dimensions(mm)	Packing	MOQ
147-31440	200x300	200x300	1	1
147-31441	200x350	200x350	1	1
147-31442	300x400	300x400	1	1
147-31443	350x500	350x500	1	1
147-31444	400x500	400x500	1	1
147-31445	400x600	400x600	1	1
147-31446	500x600	500x600	1	1
147-31447	500x700	500x700	1	1
147-31448	600x800	600x800	1	1

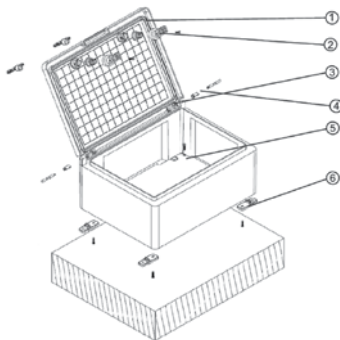

### ΤΕΧΝΙΚΑ ΧΑΡΑΚΤΗΡΙΣΤΙΚΑ TECHNICAL DETAILS

**Υλικό κιβωτίου**  
Material of body

**Υλικό πόρτας**  
Material of cover

**Όριο αντοχής**  
Endurance limit

**Βαθμός προστασίας**  
Protection class

**Ονομαστική τάση**  
Rated voltage

**ΛΕΥΚΟ**  
WHITE

ABS

ABS

IK10

IP65

690V

**ΔΙΑΦΑΝΗ ΠΟΡΤΑ**  
TRANSPARENT DOOR

ABS

PC

IK10

IP65

690V

1. ΤΟΠΟΘΕΤΗΣΗ ΦΛΑΝΤΖΑΣ ΣΤΟ ΚΑΠΑΚΙ  
GASKET PROCESS TO CAP

2. ΤΟΠΟΘΕΤΗΣΗ ΥΠΟΔΟΧΗΣ ΚΛΕΙΔΩΜΑΤΟΣ & ΠΕΙΡΟΥ ΚΛΕΙΔΩΜΑΤΟΣ  
LOCK ANCHOR AND LOCK BOLT MOUNTING

3. ΤΟΠΟΘΕΤΗΣΗ ΜΕΝΤΕΣΕΔΩΝ  
HINGE MOUNTING

4. ΤΟΠΟΘΕΤΗΣΗ ΔΑΚΤΥΛΙΟΥ ΠΕΙΡΟΥ ΚΑΙ ΠΕΙΡΩΝ  
PIN BUSHING AND PIN MOUNTING

5. ΒΙΔΩΜΑ ΤΗΣ ΠΛΑΚΑΣ ΕΠΑΝΩ ΣΤΗ ΒΑΣΗ ΤΗΣ ΠΛΑΚΑΣ  
SCREWING THE PLATE ONTO THE TRIVET OF PLATE

6. ΣΤΕΡΕΩΣΗ ΣΤΟΝ ΤΟΙΧΟ ΜΕΣΩ ΚΙΤ ΣΤΗΡΙΞΗΣ  
MOUNTING TO WALL VIA MOUNTING KIT APPARATUS

**ΦΙΛΤΡΟ ΕΞΑΕΡΙΣΜΟΥ ΓΙΑ ΚΙΒΩΤΙΟ ΠΟΛΥΚΑΡΒΟΝΙΚΟ**  
 VENTILATION FILTER FOR BOX



147-31430



147-31431



147-31432

• Production Material Plastic

Code	Barcode	Dimensions(m/mm)	Packing	MOQ
147-31430	5207227591204	105x105mm	1	1
147-31431	5207227591211	150x150mm	1	1
147-31432	5207227591228	250x250mm	1	1

**ΜΟΝΟ ΠΛΑΣΤΙΚΟ ΚΛΕΙΔΙ ΓΙΑ ΚΙΒΩΤΙΟ ΠΟΛΥΚΑΡΒΟΝΙΚΟ**  
 SINGLE PLASTIC KEY FOR BOX



• Production Material Plastic

Code	Barcode	MOQ
147-31450	5207227591235	1

**ΚΙΤ ΣΤΗΡΙΞΗΣ ΓΙΑ ΚΙΒΩΤΙΟ ΠΟΛΥΚΑΡΒΟΝΙΚΟ**  
 MOUNTING KIT FOR BOX



• Production Material Plastic

Code	Barcode	MOQ
147-31451	5207227591242	1

## ΒΙΟΜΗΧΑΝΙΚΟ ΠΛΑΣΤΙΚΟ ΦΡΕΑΤΙΟ INDUSTRIAL PLASTIC MANHOLE

• Production Material High Density PP

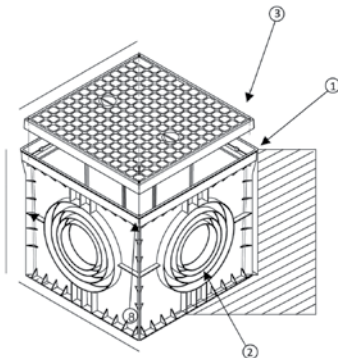

147-31910

147-31911

147-31912

147-31913

1. ΔΙΑΝΟΙΞΗ ΕΔΑΦΟΥΣ ΓΙΑ ΤΗΝ ΤΟΠΟΘΕΤΗΣΗ ΤΟΥ ΠΙΝΑΚΑ  
DIG THE GROUND FOR BOARD

2. ΑΝΟΙΓΜΑ ΤΗΣ ΚΑΤΑΛΛΗΛΗΣ ΕΙΣΟΔΟΥ ΓΙΑ ΤΟΝ ΣΩΛΗΝΑ  
OPEN THE RIGHT ENTRANCE FOR CONDUIT

3. ΒΙΔΩΜΑ ΤΟΥ ΚΑΠΑΚΙΟΥ ΣΤΟ ΣΩΜΑ  
SCREW THE COVER TO THE BODY

Code	Barcode	Dimensions(mm)	Color	Weight(kg)	Packing	MOQ
147-31900	5207227573682	200x200x200	ΓΚΡΙ/GREY	0.150	1/20	1
147-31901	5207227573699	300x300x300	ΓΚΡΙ/GREY	0.160	1/12	1
147-31902	5207227573705	400x400x400	ΓΚΡΙ/GREY	0.170	1/4	1
147-31903	5207227573712	550x550x500	ΓΚΡΙ/GREY	0.170	1/2	1

## ΠΡΑΣΙΝΟ ΚΑΠΑΚΙ ΓΙΑ ΠΛΑΣΤΙΚΟ ΦΡΕΑΤΙΟ GREEN INDUSTRIAL PLASTIC COVER

• Production Material High Density PP

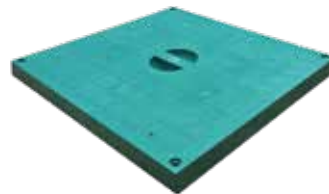
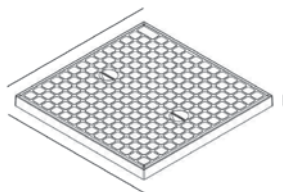

147-31910

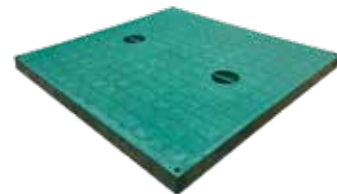

147-31911

Code	Barcode	Dimensions(mm)	Color	Weight(kg)	Packing	MOQ
147-31910	5207227573729	200x200x200	ΠΡΑΣΙΝΟ/GREEN	0.150	1/20	1
147-31911	5207227573736	300x300x300	ΠΡΑΣΙΝΟ/GREEN	0.160	1/12	1
147-31912	5207227573743	400x400x400	ΠΡΑΣΙΝΟ/GREEN	0.170	1/4	1
147-31913	5207227573750	550x550x500	ΠΡΑΣΙΝΟ/GREEN	0.170	1/2	1



### ΜΠΟΥΑΤ ΕΞΩΤΕΡΙΚΟ ΣΤΡΟΓΓΥΛΟ CIRCULAR JUNCTION BOXES

- Production Material ABS
- PG16 Ø23 • PG21 Ø29 • PG37 Ø37

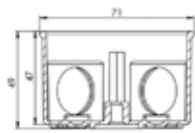

147-31500 / 147-31501

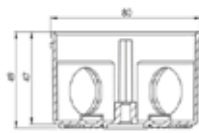

147-31502 / 147-31503

Code	Dims. (mm)	Color / Ral	Weight(kg)	Packing	MOQ
147-31500	Ø75x40	WHITE / 9010	0.076	1/12	1
147-31501	Ø75x40	GREY / 7035	0.076	1/12	1
147-31502	Ø85x40	WHITE / 9010	0.085	1/12	1
147-31503	Ø85x40	GREY / 7035	0.085	1/12	1

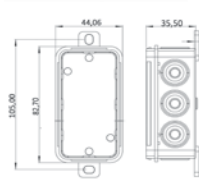

### ΜΠΟΥΑΤ ΕΞΩΤΕΡΙΚΟ SURFACE JUNCTION BOX

- Production Material ABS



Code	Dims. (mm)	Color / Ral	Weight(kg)	Packing	MOQ
147-31510	45x75x39	GREY / 7035	0.011	1/360	1

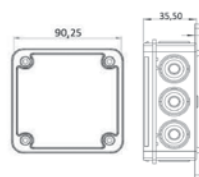

### ΜΠΟΥΑΤ ΕΞΩΤΕΡΙΚΟ SURFACE JUNCTION BOXES

- Production Material ABS



Code	Dims. (mm)	Color / Ral	Weight(kg)	Packing	MOQ
147-31511	75x75x39	GREY / 7035	0.011	1/240	1
147-31515	100x100x40	GREY / 7035	0.052	1/240	1

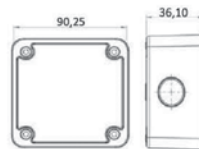

### ΜΠΟΥΑΤ ΕΞΩΤΕΡΙΚΟ SURFACE JUNCTION BOX

- Production Material ABS



Code	Dims. (mm)	Color / Ral	Weight(kg)	Packing	MOQ
147-31512	85x85x40	GREY / 7035	0.049	1/240	1

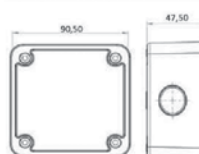

### ΜΠΟΥΑΤ ΕΞΩΤΕΡΙΚΟ SURFACE JUNCTION BOXES

- Production Material ABS



Code	Dims. (mm)	Color / Ral	Weight(kg)	Packing	MOQ
147-31513	85x85x50	GREY / 7035	0.050	1/140	1
147-31514	85x85x50	WHITE / 9010	0.050	1/140	1

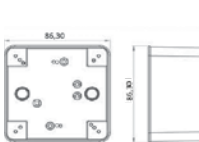

### ΜΠΟΥΑΤ ΕΞΩΤΕΡΙΚΟ ΜΕ ΒΙΔΕΣ SURFACE JUNCTION BOX WITH SCREWS

- Production Material ABS



Code	Dims. (mm)	Color / Ral	Weight(kg)	Packing	MOQ
147-31520	85x85x50	GREY / 7035	0.052	1/125	1

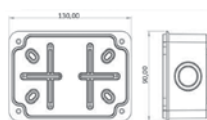

**ΜΠΟΥΑΤ ΕΞΩΤΕΡΙΚΟ ΜΕ ΒΙΔΕΣ**  
SURFACE JUNCTION BOX WITH SCREWS

• Production Material ABS



Code	Dims. (mm)	Ral	Weight(kg)	Packing	MOQ
147-31521	80x120x55	GREY / 7035	0.146	1/78	1

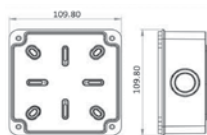

**ΜΠΟΥΑΤ ΕΞΩΤΕΡΙΚΟ ΜΕ ΒΙΔΕΣ**  
SURFACE JUNCTION BOXES WITH SCREWS

• Production Material ABS



Code	Dims. (mm)	Color / Ral	Weight(kg)	Packing	MOQ
147-31522	100x100x50	WHITE / 9010	0.130	1/112	1
147-31523	100x100x50	GREY / 7035	0.130	1/112	1

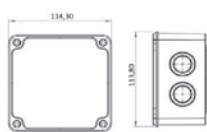

**ΜΠΟΥΑΤ ΕΞΩΤΕΡΙΚΟ ΜΕ ΒΙΔΕΣ**  
SURFACE JUNCTION BOX WITH SCREWS

• Production Material ABS



Code	Dims. (mm)	Color / Ral	Weight(kg)	Packing	MOQ
147-31524	110x110x74	GREY / 7035	0.214	1/110	1



**ΜΠΟΥΑΤ ΕΞΩΤΕΡΙΚΟ ΜΕ ΒΙΔΕΣ**  
SURFACE JUNCTION BOX WITH SCREWS

• Production Material ABS



Code	Dims. (mm)	Color / Ral	Weight(kg)	Packing	MOQ
147-31525	150x150x80	GREY / 7035	0.300	1/30	1

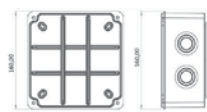

**ΜΠΟΥΑΤ ΕΞΩΤΕΡΙΚΟ ΜΕ ΒΙΔΕΣ**  
SURFACE JUNCTION BOXES WITH SCREWS

• Production Material ABS



Code	Dims. (mm)	Color / Ral	Weight(kg)	Packing	MOQ
147-31526	190x150x80	WHITE / 9010	0.331	1/30	1
147-31527	190x150x80	GREY / 7035	0.331	1/30	1

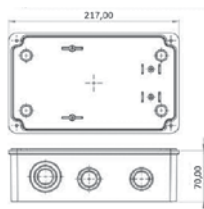

**ΜΠΟΥΑΤ ΕΞΩΤΕΡΙΚΟ ΜΕ ΒΙΔΕΣ**  
SURFACE JUNCTION BOX WITH SCREWS

• Production Material ABS



Code	Dims. (mm)	Color / Ral	Weight(kg)	Packing	MOQ
147-31528	210x120x74	GREY / 7035	0.308	1/48	1

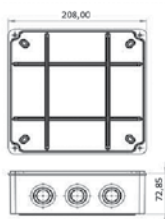

**ΜΠΟΥΑΤ ΕΞΩΤΕΡΙΚΟ ΜΕ ΒΙΔΕΣ**  
SURFACE JUNCTION BOX WITH SCREWS

• Production Material ABS



Code	Dims. (mm)	Color / Ral	Weight(kg)	Packing	MOQ
147-31529	200x200x80	GREY / 7035	0.426	1/24	1

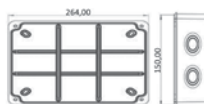

**ΜΠΟΥΑΤ ΕΞΩΤΕΡΙΚΟ ΜΕ ΒΙΔΕΣ**  
SURFACE JUNCTION BOX WITH SCREWS

• Production Material ABS



Code	Dims. (mm)	Color / Ral	Weight(kg)	Packing	MOQ
147-31530	150x260x80	GREY / 7035	0.330	1/40	1

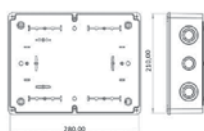

**ΜΠΟΥΑΤ ΕΞΩΤΕΡΙΚΟ ΜΕ ΒΙΔΕΣ**  
SURFACE JUNCTION BOX WITH SCREWS

• Production Material ABS



Code	Dims. (mm)	Color / Ral	Weight(kg)	Packing	MOQ
147-31531	280x210x74	GREY / 7035	0.587	1/24	1

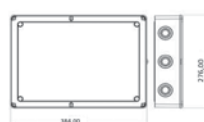

**ΜΠΟΥΑΤ ΕΞΩΤΕΡΙΚΟ ΜΕ ΒΙΔΕΣ**  
SURFACE JUNCTION BOX WITH SCREWS

• Production Material ABS



Code	Dims. (mm)	Color / Ral	Weight(kg)	Packing	MOQ
147-31532	380x280x90	GREY / 7035	0.928	1/14	1



**ΜΠΟΥΑΤ ΕΞΩΤΕΡΙΚΟ ΦΙΜΕ ΜΕ ΒΙΔΕΣ**  
SURFACE JUNCTION TINTED BOX WITH SCREWS

• Production Material ABS



Code	Dims. (mm)	Color / Ral	Weight(kg)	Packing	MOQ
147-31550	110x110x74	GREY / 7035 FUME	0.214	1/50	1



**ΜΠΟΥΑΤ ΕΞΩΤΕΡΙΚΟ ΦΙΜΕ ΜΕ ΒΙΔΕΣ**  
SURFACE JUNCTION TINTED BOX WITH SCREWS

• Production Material ABS

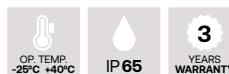

Code	Dims. (mm)	Color / Ral	Weight(kg)	Packing	MOQ
147-31551	150x150x80	GREY / 7035 FUME	0.300	1/30	1

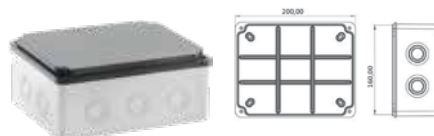

**ΜΠΟΥΑΤ ΕΞΩΤΕΡΙΚΟ ΦΙΜΕ ΜΕ ΒΙΔΕΣ**  
SURFACE JUNCTION TINTED BOX WITH SCREWS

• Production Material ABS



Code	Dims. (mm)	Color / Ral	Weight(kg)	Packing	MOQ
147-31552	190x150x80	GREY / 7035 FUME	0.331	1/30	1

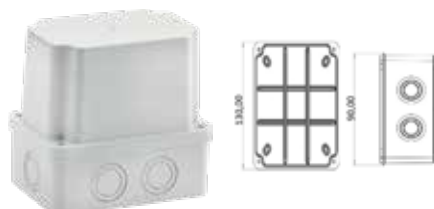

**ΒΙΟΜΗΧΑΝΙΚΟ ΜΠΟΥΑΤ ΕΞΩΤΕΡΙΚΟ ΜΕ ΒΙΔΕΣ**  
SURFACE INDUSTRIAL JUNCTION BOX WITH SCREWS

• Production Material ABS



Code	Dims. (mm)	Color / Ral	Weight(kg)	Packing	MOQ
147-31560	80x120x120	GREY / 7035	0.207	1/39	1

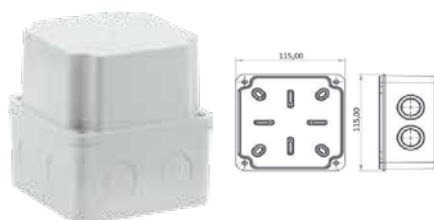

**ΒΙΟΜΗΧΑΝΙΚΟ ΜΠΟΥΑΤ ΕΞΩΤΕΡΙΚΟ ΜΕ ΒΙΔΕΣ**  
SURFACE INDUSTRIAL JUNCTION BOX WITH SCREWS

• Production Material ABS



Code	Dims. (mm)	Color / Ral	Weight(kg)	Packing	MOQ
147-31561	110x100x120	GREY / 7035	0.201	1/80	1

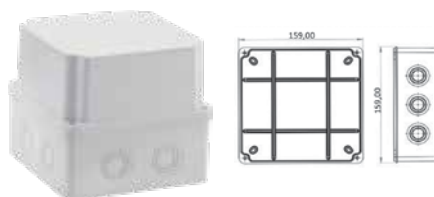

**ΒΙΟΜΗΧΑΝΙΚΟ ΜΠΟΥΑΤ ΕΞΩΤΕΡΙΚΟ ΜΕ ΒΙΔΕΣ**  
SURFACE INDUSTRIAL JUNCTION BOX WITH SCREWS

• Production Material ABS



Code	Dims. (mm)	Color / Ral	Weight(kg)	Packing	MOQ
147-31562	150x150x140	GREY / 7035	0.378	1/18	1

### ΚΟΥΤΙ ΜΕ ΣΤΥΠΙΟΘΛΗΠΤΕΣ WATERPROOF BOX WITH CABLE GLANDS

- Production Material Copper & Nylon
- Diameter Ø11mm

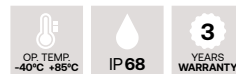

Code	Barcode	Cable Glands	Dimensions(mm)	Color	Weight(kg)	Packing	MOQ
147-11250	5207227562808	2xPG13.5	41.3x83x138	MAYPO/BLACK	0.150	1/10/50	1
147-11251	5207227562815	2xPG13.5 & PG09	41.3x98x138	MAYPO/BLACK	0.160	1/10/50	1
147-11252	5207227562822	2xPG13.5 & 2xPG09	41.3x98x138	MAYPO/BLACK	0.170	1/10/50	1
147-11253	5207227562839	4xPG09	41.3x111x108	MAYPO/BLACK	0.170	1/10/50	1
147-11254	5207227562846	PG13.3 & 4xPG09	41.3x111x122	MAYPO/BLACK	0.180	1/10/50	1

### ΚΥΤΙΑ ΓΥΦΟΣΑΝΙΔΑΣ PLASTERBOARD BOXES

- Production Material Polypropylene

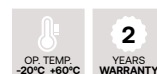

NEW

Code	Barcode	Description	Color	Weight(kg)	Packing	MOQ
151-21037	5207227573781	ΜΟΝΟ ΡΗΧΟ / SHORT	ORANGE	0.028	100	100
151-21032	5206139006967	ΜΟΝΟ / SINGLE	ORANGE	0.028	100	100
151-21035	5206139068422	ΔΙΠΛΟ / DOUBLE	ORANGE	0.044	1/100	1
151-21036	5206139068439	ΤΡΙΠΛΟ / TRIPLE	ORANGE	0.064	1/100	1

### ΚΥΤΙΑ ΔΙΑΚΛΑΔΩΣΕΩΣ ΓΥΦΟΣΑΝΙΔΑΣ PLASTERBOARD JUNCTION BOXES

- Production Material Polypropylene

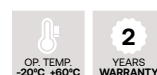

Code	Barcode	Dimensions(mm)	Color	Weight(kg)	Packing	MOQ
151-21033	5203730062804	Ø70	WHITE-RED	0.033	1/100	1
151-21034	5207227029325	Ø105	WHITE-RED	0.057	1/100	1

## ΚΟΥΤΙΑ ΔΙΑΚΛΑΔΩΣΗΣ ΣΤΡΟΓΓΥΛΑ

### ROUND JUNCTION BOXES

• Production Material Polypropylene

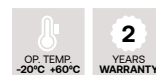

Code	Barcode	Dimensions(mm)	Packing	MOQ
151-21001	5206139630018	Ø70x35	100	100
151-21002	5206139630025	Ø100x35	50	50

## ΚΟΥΤΙ ΔΙΑΚΛΑΔΩΣΗΣ ΤΕΤΡΑΓΩΝΟ

### SQUARE JUNCTION BOX

• Production Material Polypropylene

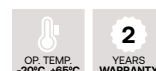
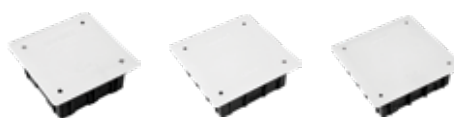

Code	Barcode	Dimensions(mm)	Color	Weight(kg)	Packing	MOQ
151-21050	5207227573798	100x100x45	ΛΕΥΚΟ-ΜΑΥΡΟ / BLACK-WHITE	0.011	1/10	1
151-21051	5207227573804	120x120x48	ΛΕΥΚΟ-ΜΑΥΡΟ / BLACK-WHITE	0.015	1/10	1
151-21052	5207227573811	150x150x52	ΛΕΥΚΟ-ΜΑΥΡΟ / BLACK-WHITE	0.024	1/10	1

## ΚΑΠΑΚΙ ΓΙΑ ΚΟΥΤΙ ΔΙΑΚΛΑΔΩΣΗΣ

### COVER PLATE FOR JUNCTION BOX

• Production Material Polypropylene

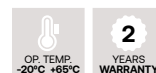

Code	Barcode	Dimensions(mm)	Color	Weight(kg)	Packing	MOQ
151-21053	5207227573828	100x100x45	ΛΕΥΚΟ/WHITE	0.036	1/400	1
151-21054	5207227573835	120x120x48	ΛΕΥΚΟ/WHITE	0.052	1/300	1
151-21055	5207227573842	150x150x52	ΛΕΥΚΟ/WHITE	0.084	1/50	1

## ΚΥΤΙΑ ΔΙΑΚΟΠΤΟΥ & ΣΥΝΔΕΣΜΟΙ

### SWITCH BOXES & CONNECTORS

• Production Material Polypropylene

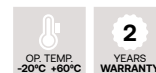

Code	Barcode	Description	Packing	MOQ
151-21000	5206139630001	ΚΟΥΤΙ ΔΙΑΚΟΠΤΟΥ/SWITCH BOX	100	100
151-21003	5206139068149	ΚΟΥΤΙ ΣΥΝΔΕΟΜΕΝΟ/SWITCH BOX CONNECTED SWITCH BOX	100	100
151-21004	5206139068163	ΣΥΝΔΕΣΜΟΣ ΚΥΤΙΟΥ/CONJUNCTION BOX	100	100
151-21008	5207227029318	ΚΟΥΤΙ ΔΙΑΚΟΠΤΟΥ ΣΥΝΔΕΟΜΕΝΟ ΒΑΘΥ/DEEP SWITCH BOX	100	100

**ΚΑΠΑΚΙ ΜΕ ΑΥΤΙΑ**  
TOP WITH EARS



Code	Barcode	Dimensions(mm)	Packing	MOQ
151-21020	5206139630209	Ø180mm	250	250
151-21021	5206139630216	SUPER Ø110mm	150	150

**ΚΑΠΑΚΙ ΠΡΟΣΤΑΣΙΑ ΠΡΙΖΑΣ**  
SOCKET COVER



Code	Barcode	Dimensions(mm)	Packing	MOQ
151-21028	5207227573774	Ø180mm	250	250

**ΓΕΜΙΣΜΑΤΑ ΠΙΝΑΚΩΣ**  
DIN RAIL ENCLOSURE FILLINGS

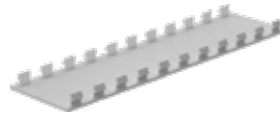

Code	Barcode	Dimensions(mm)	Packing	MOQ
151-21027	5207227573767	Ø180mm	250	250

**ΔΙΑΚΟΠΤΕΣ**  
**WALL SWITCHES**

**ΠΡΙΖΕΣ**  
**SOCKETS**

**ΜΠΟΥΤΟΝ**  
**PUSH BUTTONS**



## ΓΚΡΙ ΣΕΙΡΑ / GREY SERIES

ΕΞΩΤΕΡΙΚΟΙ ΔΙΑΚΟΠΤΕΣ / ΕΞΩΤΕΡΙΚΕΣ ΠΡΙΖΕΣ ΜΕ ΚΑΠΑΚΙ  
SURFACE ON/OFF SWITCHES / OUTDOOR SOCKETS WITH COVER

147-12230

## SWITCHES

- **Wattage** 2400W
- **Amperage** 10A
- **Voltage** 250V
- **Production Material** Copper & Plastic



147-16210

## SOCKETS

- **Wattage** 3840W
- **Amperage** 16A
- **Voltage** 250V
- **Production Material** Copper & Plastic

Code	Barcode	Description	Dimensions(mm)	Packing	MOQ
------	---------	-------------	----------------	---------	-----

## ΕΞΩΤΕΡΙΚΟΙ ΔΙΑΚΟΠΤΕΣ / SURFACE SIMPLE SWITCHES

147-12230	5206139105301	ΔΙΑΚΟΠΤΗΣ ΕΞΩΤΕΡΙΚΟΣ ON/OFF OUTDOOR SURFACE ON/OFF SWITCH	70x70x50	1/10/100	1
147-12231	5206139105318	ΔΙΑΚΟΠΤΗΣ ΕΞΩΤΕΡΙΚΟΣ Α/Ρ OUTDOOR SURFACE A/R SWITCH	70x70x50	1/10/100	1
147-12232	5206139105325	ΔΙΑΚΟΠΤΗΣ ΕΞΩΤΕΡΙΚΟΣ Κ/Ρ OUTDOOR SURFACE K/R SWITCH	70x70x50	1/10/100	1
147-12233	5206139105332	ΔΙΑΚΟΠΤΗΣ ΕΞΩΤΕΡΙΚΟΣ Κ/Ρ Α/Ρ OUTDOOR SURFACE A/R K/R SWITCH	70x70x50	1/10/100	1
147-12236	5206139105363	ΜΠΟΥΤΟΝ ΕΞΩΤΕΡΙΚΟ ΚΟΥΔΟΥΝΙΟΥ OUTDOOR SURFACE BELL PUSH-BUTTON	70x70x50	1/10/100	1

## ΕΞΩΤΕΡΙΚΕΣ ΠΡΙΖΕΣ ΜΕ ΚΑΠΑΚΙ / SOCKETS OUTDOOR WITH COVER

147-16210	5206139106100	ΠΡΙΖΑ ΕΞΩΤΕΡΙΚΗ ΣΟΥΚΟ ΜΕ ΚΑΠΑΚΙ OUTDOOR SCHUKO SOCKET & COVER	70x70x50	1/10/100	10
147-16213	5206139106131	ΠΡΙΖΑ ΣΟΥΚΟ ΔΙΠΛΗ ΜΕ ΚΑΠΑΚΙ OUTDOOR SCHUKO SOCKET DOUBLE & COVER	145x75x50	1/5/50	1
147-16215	5206139106155	ΔΙΑΚΟΠΤΗΣ Α/Ρ ΚΑΙ ΠΡΙΖΑ ΣΟΥΚΟ OUTDOOR SCHUKO SOCKET & SWITCH A/R	145x75x50	1/5/50	1
147-16216	5206139106162	ΔΙΑΚΟΠΤΗΣ Κ/Ρ Α/Ρ ΚΑΙ ΠΡΙΖΑ ΣΟΥΚΟ OUTDOOR SCHUKO SOCKET & SWITCH K/R A/R	145x75x50	1/5/50	1

## ΛΕΥΚΗ ΣΕΙΡΑ / WHITE SERIES

ΕΞΩΤΕΡΙΚΟΙ ΔΙΑΚΟΠΤΕΣ / ΕΞΩΤΕΡΙΚΕΣ ΠΡΙΖΕΣ ΜΕ ΚΑΠΑΚΙ  
SURFACE ON/OFF SWITCHES / OUTDOOR SOCKETS WITH COVER

147-12212

## SWITCHES

- **Wattage** 2400W
- **Amperage** 10A
- **Voltage** 250V
- **Production Material** Copper & Plastic



147-16220

## SOCKETS

- **Wattage** 3840W
- **Amperage** 16A
- **Voltage** 250V
- **Production Material** Copper & Plastic

Code	Barcode	Description	Dimensions(mm)	Packing	MOQ
------	---------	-------------	----------------	---------	-----

## ΕΞΩΤΕΡΙΚΟΙ ΔΙΑΚΟΠΤΕΣ / SURFACE SIMPLE SWITCHES

147-12210	5206139075451	ΔΙΑΚΟΠΤΗΣ ΕΞΩΤΕΡΙΚΟΣ ON/OFF OUTDOOR SURFACE SIMPLE SWITCH	70x70x50	1/10/100	1
147-12211	5206139075468	ΔΙΑΚΟΠΤΗΣ ΕΞΩΤΕΡΙΚΟΣ Α/Ρ OUTDOOR SURFACE A/R SWITCH	70x70x50	1/10/100	1
147-12212	5206139075475	ΔΙΑΚΟΠΤΗΣ ΕΞΩΤΕΡΙΚΟΣ Κ/Ρ OUTDOOR SURFACE K/R SWITCH	70x70x50	1/10/100	1

## ΕΞΩΤΕΡΙΚΕΣ ΠΡΙΖΕΣ ΜΕ ΚΑΠΑΚΙ / SOCKETS OUTDOOR WITH COVER

147-16220	5206139075529	ΠΡΙΖΑ ΕΞΩΤΕΡΙΚΗ ΣΟΥΚΟ ΜΕ ΚΑΠΑΚΙ OUTDOOR SCHUKO SOCKET WITH COVER	70x70x50	1/10/100	1
147-16221	5206139075536	ΠΡΙΖΑ ΕΞΩΤΕΡΙΚΗ ΣΟΥΚΟ ΔΙΠΛΗ ΜΕ ΚΑΠΑΚΙ OUTDOOR SCHUKO SOCKET DOUBLE WITH COVER	145x75x50	1/5/50	1

## ΛΕΥΚΗ ΣΕΙΡΑ / WHITE SERIES

ΕΞΩΤΕΡΙΚΟΙ ΔΙΑΚΟΠΤΕΣ / ΠΡΙΖΕΣ ΣΟΥΚΟ / TV / ΤΗΛΕΦΩΝΟΥ/ DATA  
SURFACE ON/OFF SWITCHES / SCHUKO SOCKETS / TV / PHONE / DATA

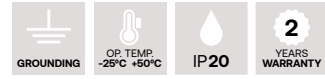

147-12240 147-12244

### SWITCHES

- Wattage 2400W
- Amperage 10A
- Voltage 250V
- Production Material Copper & Plastic



147-16254

### SCHUKO SOCKETS

- Wattage 3840W
- Amperage 16A
- Voltage 250V
- Production Material Copper & Plastic



147-16242 147-16244

### SOCKETS TV / PHONE / DATA

- Wattage 2400W
- Amperage 10A
- Voltage 250V
- Production Material Copper & Plastic

Code	Barcode	Description	Dimensions(mm)	Packing	MOQ
------	---------	-------------	----------------	---------	-----

### ΕΞΩΤΕΡΙΚΟΙ ΔΙΑΚΟΠΤΕΣ / SURFACE ON/OFF SWITCHES

147-12240	5206139105400	ΔΙΑΚΟΠΤΗΣ ΕΞΩΤΕΡΙΚΟΣ ON/OFF ΜΙΝΙ ΛΕΥΚΟΣ OUTDOOR SURFACE MINI ON/OFF SWITCH WHITE	65x65x30	1/10/200	1
147-12241	5206139105417	ΔΙΑΚΟΠΤΗΣ ΕΞΩΤΕΡΙΚΟΣ Α/Ρ ΜΙΝΙ ΛΕΥΚΟΣ OUTDOOR SURFACE MINI A/R SWITCH WHITE	65x65x30	1/10/200	1
147-12242	5206139105424	ΔΙΑΚΟΠΤΗΣ ΕΞΩΤΕΡΙΚΟΣ Κ/Ρ ΜΙΝΙ ΛΕΥΚΟΣ OUTDOOR SURFACE MINI K/R SWITCH WHITE	65x65x30	1/10/200	1
147-12244	5206139045904	ΜΠΟΥΤΟΝ ΡΟΛΛΩΝ ΜΙΝΙ ΛΕΥΚΟ SURFACE MINI SHUTTER CONTROL SWITCH	65x65x30	1/10/200	1
147-12245	5206139105455	ΜΠΟΥΤΟΝ ΚΟΥΔΟΥΝΙΟΥ ΜΙΝΙ ΛΕΥΚΟ OUTDOOR SURFACE MINI BELL PUSH-BUTTON WHITE	65x65x30	1/10/200	1
147-12246	5206139105462	ΜΠΟΥΤΟΝ ΕΞΩΤΕΡΙΚΟΣ ΚΛΙΜΑΚΟΣΤΑΣΙΟΥ-ΛΥΧΝΙΑ OUTDOOR MINI SURFACE MINI PUSH-BUTTON WITH INDICATOR	65x65x30	1/10/200	1

### ΠΡΙΖΕΣ ΣΟΥΚΟ / SOCKETS SCHUKO

147-16252	5206139106728	ΠΡΙΖΑ ΜΙΝΙ ΣΟΥΚΟ ΜΟΝΗ ΧΩΡΙΣ ΚΑΠΑΚΙ SOCKET MINI SCHUKO SINGLE WITHOUT COVER	65x65x30	1/20/200	1
147-16253	5206139106735	ΠΡΙΖΑ ΜΙΝΙ ΣΟΥΚΟ ΔΙΠΛΗ ΧΩΡΙΣ ΚΑΠΑΚΙ SOCKET MINI SCHUKO DOUBLE NO COVER	110x65x45	1/20/160	1
147-16254	5206139106742	ΠΡΙΖΑ ΜΙΝΙ ΣΟΥΚΟ ΤΡΙΠΛΗ ΧΩΡΙΣ ΚΑΠΑΚΙ SOCKET MINI SCHUKO TRIPLE WITHOUT COVER	145x65x45	1/12/144	1
147-16255	5206139106759	ΠΡΙΖΑ ΜΙΝΙ ΣΟΥΚΟ ΤΕΤΡΑΠΛΗ ΧΩΡΙΣ ΚΑΠΑΚΙ SOCKET MINI SCHUKO QUADRUPLE NO COVER	195x65x45	1/10/80	1

### ΠΡΙΖΕΣ TV, ΤΗΛΕΦΩΝΟΥ, DATA / SOCKETS TV, PHONE, DATA

147-16241	5206139106414	ΠΡΙΖΑ ΜΙΝΙ TV ΤΕΡΜΑΤΙΚΗ SOCKET MINI TV TERMINAL	65x65x30	1/10/200	1
147-16242	5206139106421	ΠΡΙΖΑ ΜΙΝΙ TV & FM ΤΕΡΜΑΤΙΚΗ SOCKET MINI TV & FM TERMINAL	65x65x30	1/10/200	1
147-16243	5206139106438	ΠΡΙΖΑ ΜΙΝΙ ΤΗΛΕΦΩΝΟΥ ΜΟΝΗ RJ11 6P4C SOCKET MINI PHONE SINGLE RJ11 6P4C	65x65x30	1/10/200	1
147-16244	5206139106445	ΠΡΙΖΑ ΜΙΝΙ ΤΗΛΕΦΩΝΟΥ ΔΙΠΛΗ RJ11 6P4C SOCKET MINI PHONE DOUBLE RJ11 6P4C	65x65x30	1/10/200	1
147-16245	5206139106452	ΠΡΙΖΑ ΜΙΝΙ DATA ΜΟΝΗ RJ45 8P8C SOCKET MINI DATA SINGLE RJ45 8P8C	65x65x30	1/10/200	1
147-16246	5206139106469	ΠΡΙΖΑ ΜΙΝΙ DATA ΔΙΠΛΗ RJ45 8P8C SOCKET MINI PHONE DOUBLE RJ45 8P8C	65x65x30	1/10/200	1
147-16247	5206139106476	ΠΡΙΖΑ ΜΙΝΙ ΤΗΛΕΦΩΝΟΥ ΔΙΠΛΗ RJ11 & RJ45 SOCKET MINI PHONE DOUBLE RJ11 & RJ45	65x65x30	1/10/200	1

## ΗΛΕΚΤΡΟΝΙΚΟΙ ΡΟΟΣΤΑΤΕΣ ΓΙΑ LED ΛΑΜΠΕΣ

ELECTRONIC DIMMERS FOR LED LAMPS

- Voltage 220-240V
- Production Material ABS & Plastic



**147-66000** LED DIMMER

Τεχνολογία που είναι ειδικά σχεδιασμένη για LED φωτισμό. Παρέχει ομαλή ρύθμιση της φωτεινότητας χωρίς θόρυβο και χωρίς προβλήματα συμβατότητας. Είναι κατάλληλο για LED λάμπες.

Technology specially designed for LED lighting. Provides smooth brightness adjustment without noise and without compatibility problems. Suitable for LED lamps.



NEW

**147-66001** 0-10V DIMMER

Χρησιμοποιεί αναλογική τάση (0-10V) για να ελέγξει τη φωτεινότητα. Η τάση 0V αντιστοιχεί σε πλήρη σβήσιμο, ενώ η τάση 10V σε πλήρη φωτεινότητα. Παρέχει ακριβή ρύθμιση της φωτεινότητας, χωρίς θόρυβο ή παρεμβολές. Κατάλληλο για LED φωτιστικά και λάμπες.

Uses analog voltage (0-10V) to control brightness. 0V voltage corresponds to full off, while 10V voltage corresponds to full brightness. Provides precise brightness control, with no noise or jitter. Suitable for LED luminaires and lamps.



NEW

**147-66002** TRIAC DIMMER

Χρησιμοποιεί Triac (Triode for Alternating Current) για να ελέγξει τη ροή του ρεύματος στο φωτιστικό, κόβοντας μέρη του κύκλου του ρεύματος εναλλασσόμενης τάσης (AC). Αποτελεί το πιο απλό και οικονομικό σύστημα. Συμβατό με λάμπες πυρακτώσεως, λάμπες αλογόνου και LED λάμπες με συμβατούς οδηγούς.

Uses Triac (Triode for Alternating Current) to control the current flow in the fixture by cutting parts of the alternating current (AC) cycle. It is the simplest and most economical system. Compatible with incandescent lamps, halogen lamps and LED lamps with compatible drivers.

Code	Barcode	Watt	Color	Dimensions(mm)	Packing	MOQ
147-66000	5207227058714	300W	WHITE	80x80x60	1/50	1
147-66001	5207227228483	400W	WHITE	80x80x60	1/50	1
147-66002	5207227494710	600W	WHITE	80x80x60	1/50	1

## ΔΙΑΚΟΠΤΑΚΙΑ ΕΝΔΙΑΜΕΣΑ

MIDDLE CORD SWITCHES

- Voltage 220-240V • Amperage 2A • Production Material PA



Code	Barcode	Watt	Color	Dimensions(mm)	Packing	MOQ
147-05800	5207227192241	1440W	WHITE	60.2x26.5x20	10/100/800	10
147-05801	5207227192258	1440W	BLACK	60.2x26.5x20	10/100/800	10
147-10044	5206139100443	1440W	WHITE	32x12x12	10/480	10
147-10045	5206139100450	1440W	BLACK	32x12x12	10/480	10

## ΠΡΟΕΚΤΑΣΗ ΚΑΛΩΔΙΟΥ ΜΕ ΦΙΣ & ΕΝΔΙΑΜΕΣΟ ΔΙΑΚΟΠΤΗ

CABLE EXTENSION WITH PLUG AND INTERMEDIATE CORD SWITCH

- Voltage 220-240V 50/60Hz • Cable Type H03VVH2-F
- Production Material Copper & PVC • Cable Cross Section 2x0.75mm



Code	Barcode	Watt	Cable Ext.(m)	Color	Dimensions(mm)	Packing	MOQ
147-13261	5207227099243	1500W	2m	WHITE	010x185x45x40	1\20\100	5
147-13262	5207227099250	1500W	2m	BLACK	010x185x45x40	1\20\100	5



# ΑΣΦΑΛΕΙΕΣ NEOZED, ΔΕΗ, ΝΟΡΜΑΛ, ΜΑΧΑΙΡΩΤΕΣ ΝΟ. 00

## FUSES NEOZET, NORMAL, BLADE NO. 00



• Production Material Porcelain & Metallic

NEOZED      NORMAL      BLADE NO. 00



147-61005      147-61020      147-61050      147-61304

Code	Barcode	Amperage	Voltage	Dimensions(mm)	Packing	MOQ
<b>NEOZED</b>						
147-61002	5207227004872	6A	400V	Ø11x36	10/100/1000	10
147-61003	5207227006142	10A	400V	Ø11x36	10/100/1000	10
147-61004	5207227006159	16A	400V	Ø11x36	10/1000	10
147-61005	5207227006166	20A	400V	Ø16x36	10/1000	10
147-61006	5207227006197	25A	400V	Ø16x36	10/50/1000	10
147-61007	5207227006210	35A	400V	Ø16x36	10/50/1000	10
147-61008	5207227006227	50A	400V	Ø16x36	10/50/1000	10
147-61009	5207227006234	63A	400V	Ø16x36	10/1000	10
147-61010	5207227006241	80A	400V	Ø24.5x43	10/500	5
147-61011	5207227006258	100A	400V	Ø24.5x43	10/300	5
<b>NOPMAΛ / NORMAL</b>						
147-61023	5207227006296	10A	500V	Ø22.5x49	5/50/500	5
147-61024	5207227006302	16A	500V	Ø22.5x49	5/50/500	5
147-61025	5207227006319	20A	500V	Ø22.5x49	5/5/50/500	5
147-61026	5207227006326	25A	500V	Ø22.5x49	5/50/500	5
147-61027	5207227006333	35A	500V	Ø27x50	5/50/350	5
147-61028	5207227006340	50A	500V	Ø27x50	5/50/350	5
147-61029	5207227006357	63A	500V	Ø27x50	5/50/350	5
147-61030	5207227006364	80A	500V	Ø37x63	10/180	5
147-61031	5207227006371	100A	500V	Ø37x63	10/180	5
<b>ΔΕΗ</b>						
147-61050	5207227006456	30A	500V	Ø12.5x50	10/100/1000	10
147-61051	5207227006463	35A	500V	Ø12.5x50	10/100/1000	10
147-61052	5207227006470	40A	500V	Ø12.5x50	10/100/1000	10
147-61053	5207227006487	50A	500V	Ø12.5x50	10/100/1000	10
<b>ΜΑΧΑΙΡΩΤΕΣ ΝΟ. 00 / BLADE NO. 00</b>						
147-61304	5207227006494	35A	500V	78x59x29	3/90	3
147-61305	5207227006500	50A	500V	78x59x29	3/90	3
147-61306	5207227006517	63A	500V	78x59x29	3/90	3
147-61307	5207227006524	80A	500V	78x59x29	3/90	3
147-61308	5207227006531	100A	500V	78x59x29	3/90	3
147-61309	5207227006548	125A	500V	78x59x29	3/90	3
147-61310	5207227006555	160A	500V	78x59x29	3/90	3

**ΚΥΛΙΝΔΡΙΚΑ ΦΥΣΙΓΓΙΑ, ΚΥΛΙΝΔΡΙΚΕΣ AC & DC**  
**FUSES CYLINDRICAL, CYLINDRICAL AC & DC**



• **Production Material** Porcelain & Metallic

CYLINDRICAL      CYLINDRICAL **DC**



147-61204

147-61214

Code	Barcode	Amperage	Voltage	Dimensions(mm)	Packing	MOQ
ΚΥΛΙΝΔΡΙΚΕΣ / CYLINDRICAL						
<b>147-61204</b>	5207227158094	25A	500V	Ø10.3x38	10/200/2000	10
<b>147-61205</b>	5207227246098	32A	500V	Ø10.3x38	10/200/2000	10
ΚΥΛΙΝΔΡΙΚΕΣ DC / CYLINDRICAL DC						
<b>147-61220</b>	5207227260414	16A	1000V	Ø10.3x38	10\200\1200	10
<b>147-61221</b>	5207227260445	20A	1000V	Ø10.3x38	10\200\1200	10
<b>147-61222</b>	5207227260476	25A	1000V	Ø10.3x38	10\200\1200	10
<b>147-61223</b>	5207227260506	32A	1000V	Ø10.3x38	10\200\1200	10

**NEOZED - ΒΑΣΕΙΣ, ΠΩΜΑΤΑ, ΚΑΛΥΜΜΑΤΑ ΠΛΗΡΗΣ**  
**FUSES - BASES, CAPS, COVERS, NEOZED SET**



• **Production Material** Porcelain & Metallic

BASES      CAPS      COVERS      SET



147-61500

147-61510

147-61520

147-61550

Code	Barcode	Amperage	Dimensions(mm)	Packing	MOQ
ΒΑΣΕΙΣ / BASES					
<b>147-61500</b>	5207227006562	63A	62x27x47 mm	20/200	20
<b>147-61501</b>	5207227006579	100A	86x44x60 mm	5/60	5
ΠΩΜΑΤΑ / CAPS					
<b>147-61510</b>	5207227006616	63A	Ø24x32 mm	20/500	20
<b>147-61511</b>	5207227006623	100A	Ø39.5x40 mm	10/240	10
ΚΑΛΥΜΜΑΤΑ / COVERS					
<b>147-61520</b>	5207227006692	63A	80.5x39x22.5 mm	36\504	6
<b>147-61521</b>	5207227006708	100A	81x49x23 mm	24\240	10
ΣΕΤ / SET					
<b>147-61550</b>	5207227006715	35A	72x27x67 mm	10\100	10

## NORMAL - ΒΑΣΕΙΣ, ΠΩΜΑΤΑ, ΚΑΛΥΜΜΑΤΑ

### NORMAL - BASES, CAPS, COVERS



• Production Material Porcelain & Metallic

BASES



147-61502

CAPS



147-61514

COVERS



147-61522

Code	Barcode	Amperage	Dimensions(mm)	Packing	MOQ
ΒΑΣΕΙΣ / BASES					
147-61502	5207227006586	25A	80.5x39x60.5	10/120	6
147-61503	5207227006593	63A	79x48x55.5	10/90	10
147-61504	5207227006609	100A	69.5x79.5x91	1/10	3
ΠΩΜΑΤΑ / CAPS					
147-61512	5207227006630	25A	Ø33.5x43	10/300	10
147-61513	5207227006647	63A	Ø42x43	10/300	10
147-61514	5207227006654	100A	Ø61x54	8/80	4
ΚΑΛΥΜΜΑΤΑ / COVERS					
147-61522	5207227006678	25A	72x27x22	36/504	6
147-61523	5207227006685	63A	84.5x44x17	24/240	10

## ΔΕΗ ΠΩΜΑ

### CAP

• Production Material Porcelain & Metallic



Code	Barcode	Amperage	Dimensions(mm)	Packing	MOQ
147-61515	5207227006661	30-50A	Ø24.5x37.5	25\500	25

## ΜΗΤΡΕΣ

### ADAPTERS

• Production Material Porcelain & Metallic



147-61040



Code	Barcode	Amperage	Dimensions(mm)	Packing	MOQ
147-61040	5207227006388	10A	Ø23x17	25/500	10
147-61041	5207227006395	16A	Ø23x17	25/500	10
147-61042	5207227006401	20A	Ø23x17	25/500	10
147-61043	5207227006418	25A	Ø23x17	25/500	10
147-61044	5207227006425	35A	Ø29x17	25/500	10
147-61045	5207227006432	50A	Ø29x17	25/500	10
147-61046	5207227006449	63A	Ø29x17	25/500	10

# EUROLAMP®

Pioneers in new technology!



# GACIA

## ΜΙΚΡΟΑΥΤΟΜΑΤΟΣ ΡΑΓΑΣ MINIATURE CIRCUIT BREAKER

### PN8H,3KA

- Μικροαυτόματος Ράγας σύμφωνα με το IEC/EN 60898-1
  - Ονομαστική ικανότητα βραχυκυκλώματος 3kA
  - Διαθέσιμος από 1 έως 4 πόλους
  - Χαρακτηριστικές καμπύλες B, C, D
  - Ονομαστικό ρεύμα έως 63A
  - Ονομαστική τάση λειτουργίας 230/400V AC
- 
- Miniature Circuit Breaker according to IEC/EN 60898-1
  - Rated short circuit breaking capacity 3kA
  - 1 up to 4-pole versions
  - Tripping characteristics B, C, D
  - Rated current up to 63A
  - Rated operational voltage 230/400V AC



Ο SB6NZ είναι ένας μικροαυτόματος διακόπτης που προορίζεται για την προστασία ενός ηλεκτρικού κυκλώματος από βλάβες που προκαλούνται από υπερβολικό ρεύμα λόγω υπερφόρτωσης ή βραχυκυκλώματος. Η βασική του λειτουργία είναι να διακόπτει τη ροή του ρεύματος μόλις εντοπιστεί μια βλάβη. Είναι κοινός σε οικιακές, εμπορικές και βιομηχανικές εφαρμογές.

SB6NZ miniature circuit breaker is an automatically operated electrical switch designed to protect an electrical circuit from damage caused by excess current from an overload or short circuit. Its basic function is to interrupt current flow after a fault is detected. They are common in domestic, commercial and industrial application. It also can be used for non-frequent on-and-off switching operations under normal circumstances.

### Product Tips

- 1 Reversible line and load connection
- 2 Contacts position indication window
- 3 International standards
- 4 Rated short circuit breaking capacity 3000A
- 5 Modifiable modules for ODM clients
- 6 Tripping characteristics B, C, D
- 7 Wide range of accessories
- 8 The position of handle lock



## ELECTRICAL FEATURES

International standard	IEC/EN 60898-1
Poles	1P, 1P+N, 2P, 3P, 3P+N, 4P
Rated current	1-63A
Tripping characteristics	B, C, D
Rated breaking capacity $I_{cn}$	3kA
Rated operational voltage $U_e$	230/400V AC
Minimum operational voltage $U_{min}$	12V AC
Maximum operational voltage $U_{max}$	440V AC
Rated frequency	50/60Hz
Rated insulated voltage $U_i$	500V AC
Rated impulse withstand voltage $U_{imp}$	6kV
Dielectric test voltage	2kV
Mechanical service life	10000 operation cycles
Electrical service life	4000 operation cycles
Line voltage connection	Arbitrary above or below

## INSTALLATION PARAMETERS

Degree of protection (IP)	IP20, IP40 (when fitted)
Operating ambient temperature	-25°C... + 70°C
Terminal connection type	Cable
Connectable conductor cross section	1-25mm <sup>2</sup>
Mounting	IEC/EN 60715 top-hat rail 35mm
Fastening torque of terminals	2-3.0N.m
Pollution degree	2
Reference temperature for setting of thermal element	30°C
Altitude	≤2000m
Relative humidity	≤95%
Resistance to humidity and heat	Class 2
Installation class	III

## COMBINATION WITH ACCESSORIES

Auxiliary contact	Yes
Alarm contact	Yes
Shunt release	Yes
Shunt release + Aux	Yes
Undervoltage release	Yes
Overvoltage release	Yes
Over & under voltage release	Yes

ΜΙΚΡΟΑΥΤΟΜΑΤΟΣ ΡΑΓΑΣ ΜΟΝΟΠΟΛΙΚΟΣ ΚΑΜΠΥΛΗ Β  
MINATURE CIRCUIT BREAKER 1P 3KA CURVE B

CODE	AMPERAGE	MODULES	PACKING
500-42300	6A	1	12\120
500-42301	10A	1	12\120
500-42302	16A	1	12\120
500-42303	20A	1	12\120
500-42304	25A	1	12\120
500-42305	32A	1	12\120
500-42306	40A	1	12\120
500-42307	50A	1	12\120
500-42308	63A	1	12\120

ΜΙΚΡΟΑΥΤΟΜΑΤΟΣ ΡΑΓΑΣ ΔΙΠΟΛΙΚΟΣ ΚΑΜΠΥΛΗ Β  
MINATURE CIRCUIT BREAKER 1 MODULE 1P+N 3KA CURVE B

CODE	AMPERAGE	MODULES	PACKING
500-42320	2X6A	1	12\120
500-42321	2X10A	1	12\120
500-42322	2X16A	1	12\120
500-42323	2X20A	1	12\120
500-42324	2X25A	1	12\120
500-42325	2X32A	1	12\120

ΜΙΚΡΟΑΥΤΟΜΑΤΟΣ ΡΑΓΑΣ ΔΙΠΟΛΙΚΟΣ ΚΑΜΠΥΛΗ Β  
MINATURE CIRCUIT BREAKER 1P+N 3KA CURVE B

CODE	AMPERAGE	MODULES	PACKING
500-42310	2X6A	2	6\60
500-42311	2X10A	2	6\60
500-42312	2X16A	2	6\60
500-42313	2X20A	2	6\60
500-42314	2X25A	2	6\60
500-42315	2X32A	2	6\60

## ΜΙΚΡΟΑΥΤΟΜΑΤΟΣ ΡΑΓΑΣ MINIATURE CIRCUIT BREAKER

### ATB6-L,6KA

- Μικροαυτόματος Ράγας σύμφωνα με το IEC/EN 60898-1
  - Ονομαστική ικανότητα διακοπής βραχυκυκλώματος 6kA
  - Διαθέσιμος σε εκδόσεις 1 έως 4 πόλων
  - Χαρακτηριστικά απενεργοποίησης B
  - Ονομαστικό ρεύμα έως 63A
  - Ονομαστική τάση λειτουργίας 230/400V AC
- 
- Miniature Circuit Breaker according to IEC/EN 60898-1
  - Rated short circuit breaking capacity 6kA
  - 1 up to 4-pole versions
  - Tripping characteristics B
  - Rated current up to 63A
  - Rated operational voltage 230/400V AC



Ο SB6NZ είναι ένας αυτόματα λειτουργούμενος ηλεκτρικός διακόπτης που προορίζεται για την προστασία ενός ηλεκτρικού κυκλώματος από βλάβες που προκαλούνται από υπερβολικό ρεύμα λόγω υπερφόρτωσης ή βραχυκυκλώματος. Η βασική του λειτουργία είναι να διακόπτει τη ροή του ρεύματος μόλις εντοπιστεί μια βλάβη. Είναι κοινός σε οικιακές, εμπορικές και βιομηχανικές εφαρμογές. Μπορεί επίσης να χρησιμοποιηθεί για μη συχνές λειτουργίες ενεργοποίησης και απενεργοποίησης υπό κανονικές συνθήκες.

SB6NZ miniature circuit breaker is an automatically operated electrical switch designed to protect an electrical circuit from damage caused by excess current from an overload or short circuit. Its basic function is to interrupt current flow after a fault is detected. They are common in domestic, commercial and industrial application. It also can be used for non-frequent on-and-off switching operations under normal circumstances.

#### Product Tips

- 1 Reversible line and load connection
- 2 Contacts position indication window
- 3 International standards
- 4 Rated short circuit breaking capacity 3000A
- 5 Modifiable modules for ODM clients
- 6 Tripping characteristics B
- 7 Wide range of accessories
- 8 The position of handle lock



## ELECTRICAL FEATURES

International standard	IEC/EN 60898-1
Poles	1P, 1P+N, 2P, 3P, 3P+N, 4P
Rated current	1-63A
Tripping characteristics	B
Rated breaking capacity $I_{cn}$	6kA
Rated operational voltage $U_e$	230/400V AC
Minimum operational voltage $U_{min}$	12V AC
Maximum operational voltage $U_{max}$	440V AC
Rated frequency	50/60Hz
Rated insulated voltage $U_i$	500V AC
Rated impulse withstand voltage $U_{imp}$	6kV
Dielectric test voltage	2kV
Mechanical service life	10000 operation cycles
Electrical service life	4000 operation cycles
Line voltage connection	Arbitrary above or below

## INSTALLATION PARAMETERS

Degree of protection (IP)	IP20, IP40 (when fitted)
Operating ambient temperature	-25°C... + 70°C
Terminal connection type	Cable
Connectable conductor cross section	1-25mm <sup>2</sup>
Mounting	IEC/EN 60715 top-hat rail 35mm
Fastening torque of terminals	2-3.0N.m
Pollution degree	2
Reference temperature for setting of thermal element	30°C
Altitude	≤2000m
Relative humidity	≤95%
Resistance to humidity and heat	Class 2
Installation class	III

**ΜΙΚΡΟΑΥΤΟΜΑΤΟΣ ΡΑΓΑΣ ΜΟΝΟΠΟΛΙΚΟΣ ΚΑΜΠΥΛΗ Β**  
 MINATURE CIRCUIT BREAKER 1P 6KA CURVE B

CODE	AMPERAGE	MODULES	PACKING
500-43100	6A	1	12\120
500-43101	10A	1	12\120
500-43102	16A	1	12\120
500-43103	20A	1	12\120
500-43104	25A	1	12\120
500-43105	32A	1	12\120

**ΜΙΚΡΟΑΥΤΟΜΑΤΟΣ ΡΑΓΑΣ ΤΡΙΠΟΛΙΚΟΣ ΚΑΜΠΥΛΗ Β**  
 MINATURE CIRCUIT BREAKER 3P 6KA CURVE B

CODE	AMPERAGE	MODULES	PACKING
500-43120	6A	3	4\40
500-43121	10A	3	4\40
500-43122	16A	3	4\40
500-43123	20A	3	4\40
500-43124	25A	3	4\40
500-43125	32A	3	4\40
500-43126	40A	3	4\40
500-43127	50A	3	4\40
500-43128	63A	3	4\40

**ΜΙΚΡΟΑΥΤΟΜΑΤΟΣ ΡΑΓΑΣ ΤΕΤΡΑΠΟΛΙΚΟΣ ΚΑΜΠΥΛΗ Β**  
 MINATURE CIRCUIT BREAKER 4P 6KA CURVE B

CODE	AMPERAGE	MODULES	PACKING
500-43138	6A	4	12\120
500-43139	10A	4	12\120
500-43140	16A	4	12\120
500-43141	20A	4	12\120
500-43142	25A	4	12\120
500-43143	32A	4	12\120
500-43144	40A	4	12\120
500-43145	50A	4	12\120
500-43146	63A	4	12\120

## ΜΙΚΡΟΑΥΤΟΜΑΤΟΣ ΡΑΓΑΣ MINIATURE CIRCUIT BREAKER

### ATB6-L,6KA

- Μικροαυτόματος Ράγας σύμφωνα με το IEC/EN 60898-1
- Ονομαστική ικανότητα διακοπής βραχυκυκλώματος 6kA
- Διαθέσιμος σε εκδόσεις 1 έως 4 πόλων
- Χαρακτηριστικά απενεργοποίησης B, C, D
- Ονομαστικό ρεύμα έως 63A
- Ονομαστική τάση λειτουργίας 230/400V AC
- Μπορεί να συνδεθεί μέσω κοινών γέφυρων (busbars).

- Miniature Circuit Breaker according to IEC/EN 60898-1
- Rated short circuit breaking capacity 3kA
- 1 up to 4-pole versions
- Tripping characteristics B, C, D
- Rated current up to 63A
- Rated operational voltage 230/400V AC
- Can be connected via standard busbars of both fork as well as pin type connection



Ο PB8N είναι ένας αυτόματα λειτουργούμενος ηλεκτρικός διακόπτης που προορίζεται για την προστασία ενός ηλεκτρικού κυκλώματος από βλάβες που προκαλούνται από υπερβολικό ρεύμα λόγω υπερφόρτωσης ή βραχυκυκλώματος. Η βασική του λειτουργία είναι να διακόπτει τη ροή του ρεύματος μόλις εντοπιστεί μια βλάβη. Είναι κοινός σε οικιακές, εμπορικές και βιομηχανικές εφαρμογές. Μπορεί επίσης να χρησιμοποιηθεί για μη συχνές λειτουργίες ενεργοποίησης και απενεργοποίησης υπό κανονικές συνθήκες.

PB8N miniature circuit breaker is an automatically operated electrical switch designed to protect an electrical circuit from damage caused by excess current from an overload or short circuit. Its basic function is to interrupt current flow after a fault is detected. They are common in domestic, commercial and industrial application.

It also can be used for non-frequent on-and-off switching operations under normal circumstances.

### Product Tips

- 1 Reversible line and load connection
- 2 Contacts position indication window
- 3 International standards
- 4 Rated short circuit breaking capacity 3000A
- 5 Modifiable modules for ODM clients
- 6 Tripping characteristics B, C, D
- 7 Wide range of accessories
- 8 The position of handle lock

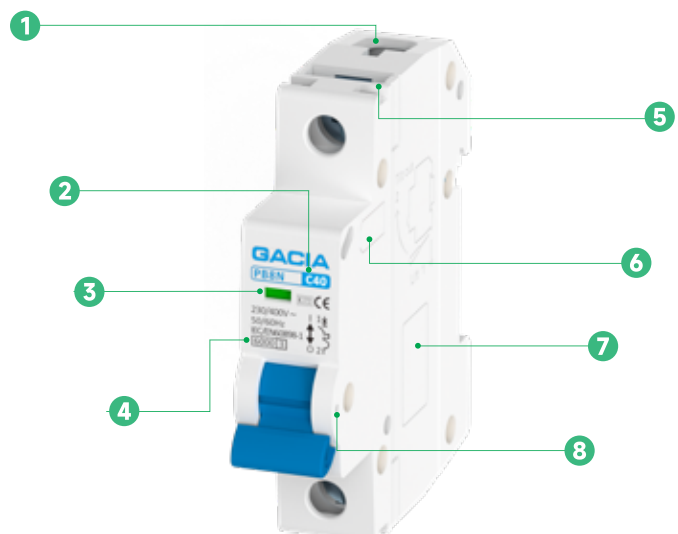

## ELECTRICAL FEATURES

International standard	IEC/EN 60898-1
Poles	1P, 1P+N, 2P, 3P, 3P+N, 4P
Rated current	1-63A
Tripping characteristics	B, C, D
Rated breaking capacity $I_{bn}$	6kA
Rated operational voltage $U_n$	230/400V AC
Minimum operational voltage $U_{min}$	12V AC
Maximum operational voltage $U_{max}$	440V AC
Rated frequency	50/60Hz
Rated insulated voltage $U_i$	500V AC
Rated impulse withstand voltage $U_{imp}$	6kV
Dielectric test voltage	2kV
Mechanical service life	10000 operation cycles
Electrical service life	4000 operation cycles
Line voltage connection	Arbitrary above or below

## INSTALLATION PARAMETERS

Degree of protection (IP)	IP20, IP40 (when fitted)
Operating ambient temperature	-25°C <sub>-</sub> + 70°C
Terminal connection type	Cable
Connectable conductor cross section	1-25mm <sup>2</sup>
Mounting	IEC/EN 60715 top-hat rail 35mm
Fastening torque of terminals	2-3.0N.m
Pollution degree	2
Reference temperature for setting of thermal element	30°C
Altitude	≤2000m
Relative humidity	≤95%
Resistance to humidity and heat	Class 2
Installation class	III

## COMBINATION WITH ACCESSORIES

Auxiliary contact	Yes	Shunt release	Yes	Undervoltage release	Yes	Over & under voltage release	Yes
Alarm contact	Yes	Shunt release + Aux	Yes	Overvoltage release	Yes		

ΜΙΚΡΟΑΥΤΟΜΑΤΟΣ ΡΑΓΑΣ ΜΟΝΟΠΟΛΙΚΟΣ ΚΑΜΠΥΛΗ C  
MINIATURE CIRCUIT BREAKER 1P 6kA CURVE C

CODE	AMPERAGE	MODULES	PACKING
500-43000	6A	1	12\120
500-43001	10A	1	12\120
500-43002	16A	1	12\120
500-43003	20A	1	12\120
500-43004	25A	1	12\120
500-43005	32A	1	12\120
500-43006	40A	1	12\120
500-43007	50A	1	12\120
500-43008	63A	1	12\120

ΜΙΚΡΟΑΥΤΟΜΑΤΟΣ ΡΑΓΑΣ ΔΙΠΟΛΙΚΟΣ ΚΑΜΠΥΛΗ C  
MINIATURE CIRCUIT BREAKER 2P 6kA CURVE C

CODE	AMPERAGE	MODULES	PACKING
500-43010	6A	2	6\60
500-43011	10A	2	6\60
500-43012	16A	2	6\60
500-43013	20A	2	6\60
500-43014	25A	2	6\60
500-43015	32A	2	6\60
500-43016	40A	2	6\60
500-43017	50A	2	6\60
500-43018	63A	2	6\60

ΜΙΚΡΟΑΥΤΟΜΑΤΟΣ ΡΑΓΑΣ ΔΙΠΟΛΙΚΟΣ ΚΑΜΠΥΛΗ C  
MINIATURE CIRCUIT BREAKER 1P+N 6kA CURVE C

CODE	AMPERAGE	MODULES	PACKING
500-43040	6A	1	12\120
500-43041	10A	1	12\120
500-43042	16A	1	12\120
500-43043	20A	1	12\120
500-43044	25A	1	12\120
500-43045	32A	1	12\120

ΜΙΚΡΟΑΥΤΟΜΑΤΟΣ ΡΑΓΑΣ ΤΕΤΡΑΠΟΛΙΚΟΣ ΚΑΜΠΥΛΗ C  
MINIATURE CIRCUIT BREAKER 4P 6kA CURVE C

CODE	AMPERAGE	MODULES	PACKING
500-43170	6A	4	4\40
500-43171	10A	4	4\40
500-43172	16A	4	4\40
500-43173	20A	4	4\40
500-43174	25A	4	4\40
500-43175	32A	4	4\40
500-43176	40A	4	4\40
500-43177	50A	4	4\40
500-43178	63A	4	4\40
500-43179	80A	4	4\40
500-43180	100A	4	4\40

ΜΙΚΡΟΑΥΤΟΜΑΤΟΣ ΡΑΓΑΣ ΤΡΙΠΟΛΙΚΟΣ ΚΑΜΠΥΛΗ C  
MINIATURE CIRCUIT BREAKER 3P 6kA CURVE C

CODE	AMPERAGE	MODULES	PACKING
500-43020	6A	3	4\40
500-43021	10A	3	4\40
500-43022	16A	3	4\40
500-43023	20A	3	4\40
500-43024	25A	3	4\40
500-43025	32A	3	4\40
500-43026	40A	3	4\40
500-43027	50A	3	4\40
500-43028	63A	3	4\40

## ΜΙΚΡΟΑΥΤΟΜΑΤΟΣ ΡΑΓΑΣ MINIATURE CIRCUIT BREAKER

### ATB6-L,6KA

- Μικροαυτόματος Ράγας σύμφωνα με το IEC/EN 60898-1
  - Ονομαστική ικανότητα διακοπής βραχυκυκλώματος 6kA
  - Διαθέσιμος σε εκδόσεις 1 έως 4 πόλων
  - Χαρακτηριστικά απενεργοποίησης B
  - Ονομαστικό ρεύμα έως 63A
  - Ονομαστική τάση λειτουργίας 230/400V AC
- 
- Miniature Circuit Breaker according to IEC/EN 60898-1
  - Rated short circuit breaking capacity 6kA
  - 1 up to 4-pole versions
  - Tripping characteristics B
  - Rated current up to 63A
  - Rated operational voltage 230/400V AC



Ο SB6NZ είναι ένας αυτόματα λειτουργούμενος ηλεκτρικός διακόπτης που προορίζεται για την προστασία ενός ηλεκτρικού κυκλώματος από βλάβες που προκαλούνται από υπερβολικό ρεύμα λόγω υπερφόρτωσης ή βραχυκυκλώματος. Η βασική του λειτουργία είναι να διακόπτει τη ροή του ρεύματος μόλις εντοπιστεί μια βλάβη. Είναι κοινός σε οικιακές, εμπορικές και βιομηχανικές εφαρμογές. Μπορεί επίσης να χρησιμοποιηθεί για μη συχνές λειτουργίες ενεργοποίησης και απενεργοποίησης υπό κανονικές συνθήκες.

SB6NZ miniature circuit breaker is an automatically operated electrical switch designed to protect an electrical circuit from damage caused by excess current from an overload or short circuit. Its basic function is to interrupt current flow after a fault is detected. They are common in domestic, commercial and industrial application. It also can be used for non-frequent on-and-off switching operations under normal circumstances.

#### Product Tips

- 1 Reversible line and load connection
- 2 Contacts position indication window
- 3 International standards
- 4 Rated short circuit breaking capacity 3000A
- 5 Modifiable modules for ODM clients
- 6 Tripping characteristics B
- 7 Wide range of accessories
- 8 The position of handle lock



## ELECTRICAL FEATURES

International standard	IEC/EN 60898-1
Poles	1P, 1P+N, 2P, 3P, 3P+N, 4P
Rated current	1-63A
Tripping characteristics	B
Rated breaking capacity $I_{cn}$	6kA
Rated operational voltage $U_e$	230/400V AC
Minimum operational voltage $U_{min}$	12V AC
Maximum operational voltage $U_{max}$	440V AC
Rated frequency	50/60Hz
Rated insulated voltage $U_i$	500V AC
Rated impulse withstand voltage $U_{imp}$	6kV
Dielectric test voltage	2kV
Mechanical service life	10000 operation cycles
Electrical service life	4000 operation cycles
Line voltage connection	Arbitrary above or below

## INSTALLATION PARAMETERS

Degree of protection (IP)	IP20, IP40 (when fitted)
Operating ambient temperature	-25°C... + 70°C
Terminal connection type	Cable
Connectable conductor cross section	1-25mm <sup>2</sup>
Mounting	IEC/EN 60715 top-hat rail 35mm
Fastening torque of terminals	2-3.0N.m
Pollution degree	2
Reference temperature for setting of thermal element	30°C
Altitude	≤2000m
Relative humidity	≤95%
Resistance to humidity and heat	Class 2
Installation class	III

### ΜΙΚΡΟΑΥΤΟΜΑΤΟΣ ΡΑΓΑΣ ΜΟΝΟΠΟΛΙΚΟΣ ΚΑΜΠΥΛΗ D MINATURE CIRCUIT BREAKER 1P 6KA CURVE D

CODE	AMPERAGE	MODULES	PACKING
500-43200	6A	1	12\120
500-43201	10A	1	12\120
500-43202	16A	1	12\120
500-43203	20A	1	12\120
500-43204	25A	1	12\120
500-43205	32A	1	12\120
500-43206	40A	1	12\120
500-43207	50A	1	12\120
500-43208	63A	1	12\120

### ΜΙΚΡΟΑΥΤΟΜΑΤΟΣ ΡΑΓΑΣ ΔΙΠΟΛΙΚΟΣ ΚΑΜΠΥΛΗ D MINATURE CIRCUIT BREAKER 1P+N 6KA CURVE D

CODE	AMPERAGE	MODULES	PACKING
500-43210	6A	1	12\120
500-43211	10A	1	12\120
500-43212	16A	1	12\120
500-43213	20A	1	12\120
500-43214	25A	1	12\120
500-43215	32A	1	12\120
500-43216	40A	1	12\120
500-43217	50A	1	12\120
500-43218	63A	1	12\120

### ΜΙΚΡΟΑΥΤΟΜΑΤΟΣ ΡΑΓΑΣ ΤΡΙΠΟΛΙΚΟΣ ΚΑΜΠΥΛΗ D MINATURE CIRCUIT BREAKER 3P 6KA CURVE D

CODE	AMPERAGE	MODULES	PACKING
500-43230	6A	3	4\40
500-43231	10A	3	4\40
500-43232	16A	3	4\40
500-43233	20A	3	4\40
500-43234	25A	3	4\40
500-43235	32A	3	4\40
500-43236	40A	3	4\40
500-43237	50A	3	4\40
500-43238	63A	3	4\40

### ΜΙΚΡΟΑΥΤΟΜΑΤΟΣ ΡΑΓΑΣ ΤΕΤΡΑΠΟΛΙΚΟΣ ΚΑΜΠΥΛΗ D MINATURE CIRCUIT BREAKER 4P 6KA CURVE D

CODE	AMPERAGE	MODULES	PACKING
500-43250	6A	4	12\120
500-43251	10A	4	12\120
500-43252	16A	4	12\120
500-43253	20A	4	12\120
500-43254	25A	4	12\120
500-43255	32A	4	12\120
500-43256	40A	4	12\120
500-43257	50A	4	12\120
500-43258	63A	4	12\120
500-43259	80A	4	12\120
500-43260	100A	4	12\120

## ΜΙΚΡΟΑΥΤΟΜΑΤΟΣ ΡΑΓΑΣ MINIATURE CIRCUIT BREAKER

### PB8H,10KA

- Μικροαυτόματος Ράγας σύμφωνα με το IEC/EN 60898-1
  - Ονομαστική ικανότητα διακοπής βραχυκυκλώματος 10kA
  - Διαθέσιμος σε εκδόσεις 1 έως 4 πόλων
  - Χαρακτηριστικά απενεργοποίησης B, C, D
  - Ονομαστικό ρεύμα έως 63A
  - Ονομαστική τάση λειτουργίας 230/400V AC
  - Μπορεί να συνδεθεί μέσω κοινών γεφυρών (busbars).
- Miniature Circuit Breaker according to IEC/EN 60898-1
  - Rated short circuit breaking capacity 10kA
  - 1 up to 4-pole versions
  - Tripping characteristics B, C, D
  - Rated current up to 63A
  - Rated operational voltage 230/400V AC
  - Can be connected via standard busbars of both fork as well as pin type of connection



Ο PB8H είναι ένας αυτόματα λειτουργούμενος ηλεκτρικός διακόπτης που προορίζεται για την προστασία ενός ηλεκτρικού κυκλώματος από βλάβες που προκαλούνται από υπερβολικό ρεύμα λόγω υπερφόρτωσης ή βραχυκυκλώματος. Η βασική του λειτουργία είναι να διακόπτει τη ροή του ρεύματος μόλις εντοπιστεί μια βλάβη. Είναι κοινός σε οικιακές, εμπορικές και βιομηχανικές εφαρμογές. Μπορεί επίσης να χρησιμοποιηθεί για μη συχνές λειτουργίες ενεργοποίησης και απενεργοποίησης υπό κανονικές συνθήκες.

PB8H miniature circuit breaker is an automatically operated electrical switch designed to protect an electrical circuit from damage caused by excess current from an overload or short circuit. Its basic function is to interrupt current flow after a fault is detected. They are common in domestic, commercial and industrial application. It also can be used for non-frequent on-and-off switching operations under normal circumstances.

#### Product Tips

- 1 Reversible line and load connection
- 2 Tripping characteristics B, C, D
- 3 Contacts position indication window
- 4 Rated short circuit breaking capacity 10000A
- 5 Busbar interface
- 6 Wide range of accessories
- 7 Modifiable modules for ODM clients
- 8 The position of handle lock

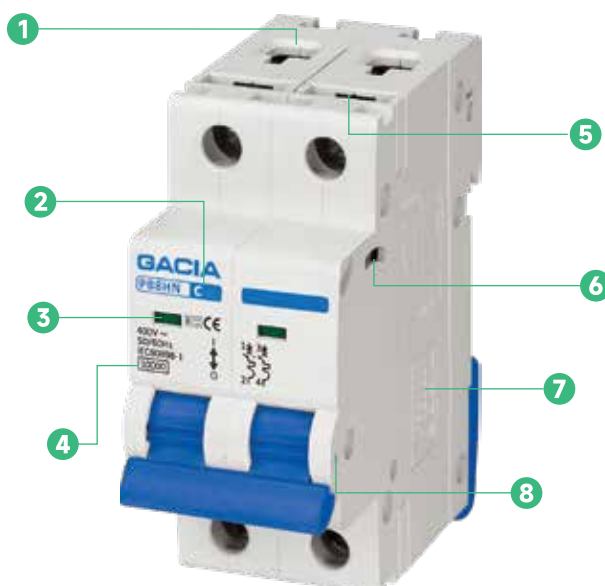

## ELECTRICAL FEATURES

International standard	IEC/EN 60898-1
Poles	1P, 1P+N, 2P, 3P, 3P+N, 4P
Rated current	1-63A
Tripping characteristics	B, C, D
Rated breaking capacity $I_{cn}$	10kA
Rated operational voltage $U_e$	230/400V AC
Minimum operational voltage $U_{min}$	12V AC
Maximum operational voltage $U_{max}$	440V AC
Rated frequency	50/60Hz
Rated insulated voltage $U_i$	500V AC
Rated impulse withstand voltage $U_{imp}$	6kV
Dielectric test voltage	2kV
Mechanical service life	10000 operation cycles
Electrical service life	4000 operation cycles
Line voltage connection	Arbitrary above or below

## INSTALLATION PARAMETERS

Degree of protection (IP)	IP20, IP40 (when fitted)
Operating ambient temperature	-25°C... + 70°C
Terminal connection type	Cable/Busbar
Connectable conductor cross section	1-25mm <sup>2</sup>
Mounting	IEC/EN 60715 top-hat rail 35mm
Fastening torque of terminals	2-3.0N.m
Pollution degree	2
Reference temperature for setting of thermal element	30°C
Altitude	≤2000m
Relative humidity	≤95%
Resistance to humidity and heat	Class 2
Installation class	III

## COMBINATION WITH ACCESSORIES

Auxiliary contact	Yes
Alarm contact	Yes
Shunt release	Yes
Shunt release + Aux	Yes
Undervoltage release	Yes
Overvoltage release	Yes
Over & under voltage release	Yes

**ΜΙΚΡΟΑΥΤΟΜΑΤΟΣ ΡΑΓΑΣ ΔΙΠΟΛΙΚΟΣ ΚΑΜΠΥΛΗ C**  
 MINATURE CIRCUIT BREAKER 1P+N 10kA CURVE C

CODE	AMPERAGE	MODULES	PACKING
500-43300	20A	2	6\60
500-43301	32A	2	6\60
500-43302	40A	2	6\60
500-43303	63A	2	6\60

**ΜΙΚΡΟΑΥΤΟΜΑΤΟΣ ΡΑΓΑΣ ΤΕΤΡΑΠΟΛΙΚΟΣ ΚΑΜΠΥΛΗ C**  
 MINATURE CIRCUIT BREAKER 3P+N 10kA CURVE C

CODE	AMPERAGE	MODULES	PACKING
500-43310	20A	4	3\30
500-43311	32A	4	3\30
500-43312	40A	4	3\30
500-43313	63A	4	3\30

## ΡΑΓΟΔΙΑΚΟΠΤΕΣ DIN RAIL ISOLATOR SWITCHES

### DL

- Ραγοδιακόπτης
  - Ονομαστικό ρεύμα βραχυκύκλωση  $I_{cw}=12 \times I_e,1s$
  - Διαθέσιμος 1 έως 4 πόλους
  - Ονομαστικό ρεύμα έως 125A
  - Ονομαστική τάση λειτουργίας 230/400V AC
  - Μπορεί να συνδεθεί μέσω κοινών γεφυρών (busbars)
- 
- Modular Isolator
  - Rated short-time withstand current  $I_{cw}=12 \times I_e,1s$
  - 1 up to 4-pole versions
  - Rated current up to 125A
  - Rated operational voltage 230/400V AC
  - Can be connected via standard busbars of both fork as well as pin type of connection



Ο ραγοδιακόπτης DL χρησιμοποιείται για να εξασφαλίσει ότι ένα ηλεκτρικό κύκλωμα αποσυνδέεται πλήρως από την παροχή ρεύματος κατά τη διάρκεια συντήρησης ή επισκευής.

DL Isolator is used to ensure that an electrical circuit is completely disconnects for service or maintenance. They are only used for disconnecting the circuit and are often found in electrical distribution and industrial applications, where machinery must have its source of driving power removed for adjustment or repair.

### Product Tips

- 1 Reversible line and load connection
- 2 Rated current up to 125A
- 3 Contacts position indication window
- 4 International standards
- 5 Busbar interface
- 6 Modifiable modules for ODM clients
- 7 The position of handle lock

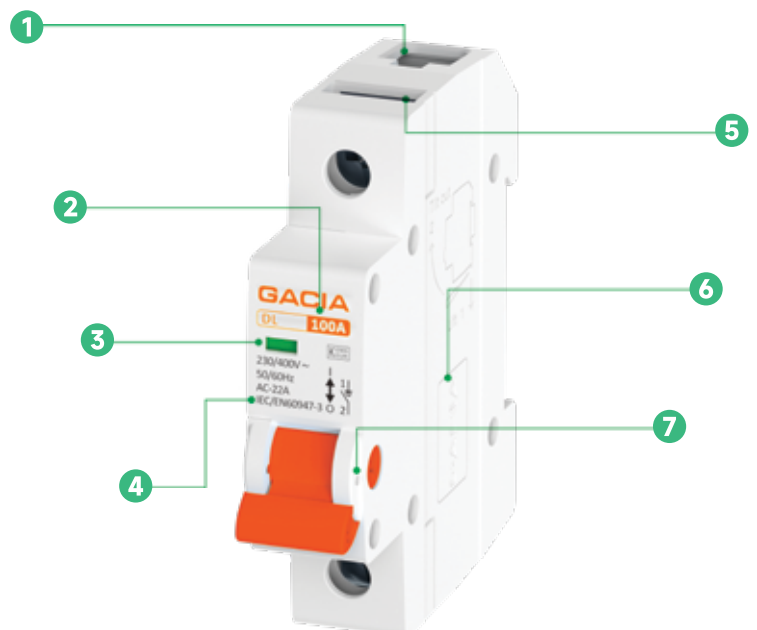

## ELECTRICAL FEATURES

International standard	IEC/EN 60898-1	
Poles	1P, 2P, 3P, 4P	
Rated current	63-125A	
Utilization category	AC-22A	
Rated operational voltage $U_e$	230/400V AC	
Rated frequency	50/60Hz	
Rated insulated voltage $U_i$	500V AC	
Rated impulse withstand voltage $U_{imp}$	6kV	
Rated short-time withstand current $I_{cw}$ , 1s	12× $I_e$	
Rated short-time making capacity $I_{cm}$	$I_n=63A$	1260A
	$I_n=80, 100, 125A$	2500A
Mechanical service life	10000 operation cycles	
Electrical service life	4000 operation cycles	

## INSTALLATION PARAMETERS

Degree of protection (IP)	IP20, IP40 (when fitted)
Operating ambient temperature	-25°C <sub>min</sub> + 70°C
Terminal connection type	Cable/Busbar
Connectable conductor cross section	16-50mm <sup>2</sup>
Mounting	IEC/EN 60715 top-hat rail 35mm
Fastening torque of terminals	2-3.5N.m
Pollution degree	2
Altitude	≤2000m
Relative humidity	≤95%
Resistance to humidity and heat	Class 2
Installation class	III

## COMBINATION WITH ACCESSORIES

Auxiliary contact	No	Undervoltage release	No
Alarm contact	No	Overvoltage release	No
Shunt release	No	Over & under voltage release	No
Shunt release + Aux	No		

ΡΑΓΟΔΙΑΚΟΠΤΕΣ  
DIN RAIL ISOLATOR SWITCHES

CODE	AMPERAGE	MODULES	PACKING
500-43600	1X25A	1	12\120
500-43601	1X40A	1	12\120
500-43602	1X63A	1	12\120
500-43603	2X25A	2	6\60
500-43604	2X40A	2	6\60
500-43605	2X63A	2	6\60
500-43606	3X40A	3	4\40
500-43607	3X63A	3	4\40
500-43608	3X80A	3	4\40
500-43609	3X100A	3	4\40
500-43610	3X125A	3	4\40
500-43611	4X40A	4	3\30
500-43612	4X63A	4	3\30
500-43613	4X80A	4	3\30
500-43614	4X100A	4	3\30
500-43615	4X125A	4	3\30

## ΔΙΑΚΟΠΤΕΣ ΔΙΑΡΡΟΗΣ RESIDUAL CURRENT CIRCUIT BREAKER

# PR8NE, 6kA, RCCB ELECTRONIC

- Διακόπτες διαρροής σύμφωνα με το IEC/EN 61008-1
  - Ηλεκτρονικός τύπος
  - Ρεύμα βραχυκυκλώματος Inc 6kA
  - Διαθέσιμο σε 2 και 4 πόλους
  - Ρεύμα διαρροής 30mA και 300mA
  - Ονομαστικό ρεύμα έως 63A
  - Ονομαστική τάση λειτουργίας 230/400V AC
  - Διαθέσιμο σε AC και A τύπους
- 
- Residual Current Circuit Breaker according to IEC/EN 61008-1
  - Electronic type
  - Cond. rated short circuit strength Inc 6kA
  - 2 and 4-pole versions
  - Rated residual current 10, 30, 100, 300mA and 500mA
  - Rated current up to 63A
  - Rated operational voltage 230/400V AC
  - AC and A types



Ο διακόπτης διαρροής PR8NE είναι μια συσκευή ασφαλείας που διακόπτει γρήγορα ένα ηλεκτρικό κύκλωμα για να προστατεύσει από την διαρροή.

PR8NE residual current circuit breaker is a safety device that quickly breaks off an electrical circuit to protect equipment, they are designed to disconnect the conducting wires ("trip") quickly enough to potentially prevent serious injury to humans, and to prevent damage to electrical devices. They are common in domestic, commercial and industrial application.

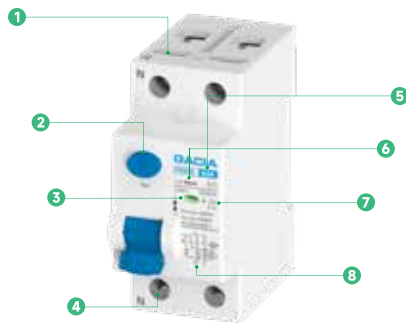

### Product Tips

- 1 Busbar interface
- 2 Test button
- 3 Contacts position indication window
- 4 Neutral line interface
- 5 Rated current up to 63A
- 6 Variants from 10 to 500mA  $I_{\Delta n}$  available
- 7 Sensitivity to residual current A
- 8 Electronic circuit diagram

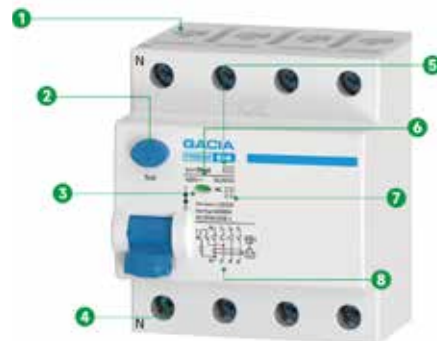

### Product Tips

- 1 Busbar interface
- 2 Test button
- 3 Contacts position indication window
- 4 Neutral line interface
- 5 Rated current up to 63A
- 6 Variants from 10 to 300mA  $I_{\Delta n}$  available
- 7 Sensitivity to residual current A
- 8 Electronic circuit diagram

## ELECTRICAL FEATURES

International standard	IEC/EN 61008-1	Sensitivity to residual current	AC type - AC residual current / A type - residual AC & pulsating DC current
Poles	2P, 4P	Time characteristic	AC, A - Undelayed type
Rated current	25, 40, 63A	Rated insulated voltage $U_i$	500V AC
Rated residual current $I_{\Delta n}$	10, 30, 100, 300, 500mA	Rated impulse withstand voltage $U_{imp}$	4kV
Residual current protection type	Electronic	Dielectric test voltage	2.5kV
Conditional short circuit strength $I_{nc}$	6kA	Mechanical service life	10000 operation cycles
Rated operational voltage $U_e$	230/400V AC	Electrical service life	4000 operation cycles
Voltage range of the test button T	195.5-253V AC(2P)/195.5-440V AC(4P)		

Back-up fuse for overload		Back-up fuse for short circuit		Rated residual making and breaking capacity $I_m / I_{\Delta m}$
$I_n=25A$	max, 25AgG	$I_n=25A$	max, 63AgG	$I_n=25A$ 500A
$I_n=40A$	max, 32AgG	$I_n=40A$	max, 63AgG	$I_n=40A$ 500A
$I_n=63A$	max, 50AgG	$I_n=63A$	max, 63AgG	$I_n=63A$ 630A

## INSTALLATION PARAMETERS

Degree of protection (IP)	IP20, IP40 (when fitted)	Pollution degree	2
Operating ambient temperature	-25°C...+70°C	Altitude	≤2000m
Terminal connection type	Cable/Busbar	Relative humidity	≤95%
Connectable conductor cross section	1-25mm <sup>2</sup>	Resistance to humidity and heat	Class 2
Mounting	IEC/EN 60715 top-hat rail 35mm	Installation class	III
Fastening torque of terminals	2-3.5N.m		

**ΔΙΑΚΟΠΤΗΣ ΔΙΑΡΡΟΗΣ ΤΥΠΟΥ A**  
 RESIDUAL CURRENT CIRCUIT BREAKER 30MA 6KA TYPE A

CODE	AMPERAGE	MODULES	PACKING
500-37500	2X25A	2	6\60
500-37501	2X32A	2	6\60
500-37502	2X40A	2	6\60
500-37503	2X63A	2	6\60
500-37510	4X25A	4	3\30
500-37511	4X32A	4	3\30
500-37512	4X40A	4	3\30
500-37513	4X63A	4	3\30
500-37514	4X80A	4	3\30
500-37515	4X100A	4	3\30

**ΔΙΑΚΟΠΤΗΣ ΔΙΑΡΡΟΗΣ ΤΥΠΟΥ A**  
 RESIDUAL CURRENT CIRCUIT BREAKER 300MA 6KA TYPE A

CODE	AMPERAGE	MODULES	PACKING
500-37520	2X25A	2	6\60
500-37521	2X32A	2	6\60
500-37522	2X40A	2	6\60
500-37523	2X63A	2	6\60
500-37530	4X25A	4	3\30
500-37531	4X32A	4	3\30
500-37532	4X40A	4	3\30
500-37533	4X63A	4	3\30
500-37534	4X80A	4	3\30
500-37535	4X100A	4	3\30

**ΔΙΑΚΟΠΤΗΣ ΔΙΑΡΡΟΗΣ ΤΥΠΟΥ AC+S**  
 RESIDUAL CURRENT CIRCUIT BREAKER 300MA 10KA TYPE AC+S

CODE	AMPERAGE	MODULES	PACKING
500-37540	2X63A	2	6\60
500-37545	4X63A	4	3\30

## ΔΙΑΚΟΠΤΕΣ ΔΙΑΡΡΟΗΣ RESIDUAL CURRENT CIRCUIT BREAKER

# PR8NM,6KA, RCCB

ELECTROMAGNETIC

- Διακόπτες διαρροής σύμφωνα με το IEC/EN 61008-1
  - Ηλεκτρονικός τύπος
  - Ονομαστική αντοχή σε βραχυκύκλωμα  $I_{nc}$  6kA
  - Εκδόσεις 2 και 4 πόλων
  - Ονομαστικό υπολειπόμενο ρεύμα 10, 30, 100, 300mA
  - Ονομαστικό ρεύμα έως 63A
  - Ονομαστική τάση λειτουργίας 230/400V AC
  - Τύποι AC και A
- 
- Residual Current Circuit Breaker according to IEC/EN 61008-1
  - Electronic type
  - Cond. rated short circuit strength  $I_{nc}$  6kA
  - 2 and 4-pole versions
  - Rated residual current 10, 30, 100, 300mA
  - Rated current up to 63A
  - Rated operational voltage 230/400V AC
  - AC and A types



Ο διακόπτης διαρροής PR8NM είναι μια συσκευή ασφαλείας που διακόπτει γρήγορα ένα ηλεκτρικό κύκλωμα για να προστατεύσει τον εξοπλισμό. Είναι σχεδιασμένος να αποσυνδέει τα αγώγιμα καλώδια αρκετά γρήγορα ώστε να προλάβει ενδεχόμενο σοβαρό τραυματισμό σε ανθρώπους και να αποτρέψει βλάβες σε ηλεκτρικές συσκευές. Συνήθως χρησιμοποιούνται σε οικιακές, εμπορικές και βιομηχανικές εφαρμογές.

PR8NM residual current circuit breaker is a safety device that quickly breaks off an electrical circuit to protect equipment, they are designed to disconnect the conducting wires ("trip") quickly enough to potentially prevent serious injury to humans, and to prevent damage to electrical devices. Usually used in domestic, commercial and industrial application.

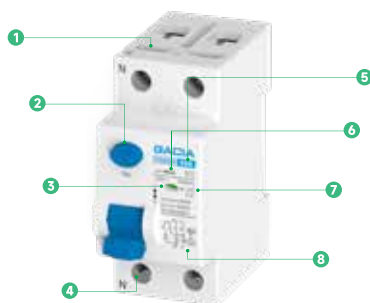

### Product Tips

- 1 Busbar interface
- 2 Test button
- 3 Contacts position indication window
- 4 Neutral line interface
- 5 Rated current up to 63A
- 6 Variants from 10 to 500mA  $I_{\Delta n}$  available
- 7 Sensitivity to residual current A
- 8 Electronic circuit diagram

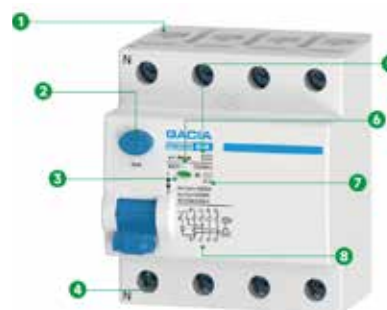

### Product Tips

- 1 Busbar interface
- 2 Test button
- 3 Contacts position indication window
- 4 Neutral line interface
- 5 Rated current up to 63A
- 6 Variants from 10 to 300mA  $I_{\Delta n}$  available
- 7 Sensitivity to residual current A
- 8 Electronic circuit diagram

## ELECTRICAL FEATURES

International standard	IEC/EN 61008-1	Sensitivity to residual current	AC type - AC residual current / A type - residual AC & pulsating DC current
Poles	2P, 4P	Time characteristic	AC, A - Undelayed type
Rated current	25, 40, 63A	Rated insulated voltage $U_i$	500V AC
Rated residual current $I_{\Delta n}$	10, 30, 100, 300, 300mA	Rated impulse withstand voltage $U_{imp}$	6kV
Residual current protection type	Electromagnetic	Dielectric test voltage	2.5kV
Conditional short circuit strength $I_{nc}$	6kA	Mechanical service life	10000 operation cycles
Rated operational voltage $U_e$	230/400V AC	Electrical service life	4000 operation cycles
Voltage range of the test button T	195.5-253V AC(2P)/195.5-440V AC(4P)		

Back-up fuse for overload		Back-up fuse for short circuit		Rated residual making and breaking capacity $I_m / I_{\Delta m}$	
$I_n=25A$	max, 25AgG	$I_n=25A$	max, 63AgG	$I_n=25A$	500A
$I_n=40A$	max, 32AgG	$I_n=40A$	max, 63AgG	$I_n=40A$	500A
$I_n=63A$	max, 50AgG	$I_n=63A$	max, 63AgG	$I_n=63A$	630A
				Line Voltage Connection	Arbitrary above or below

## INSTALLATION PARAMETERS

Degree of protection (IP)	IP20, IP40 (when fitted)	Pollution degree	2
Operating ambient temperature	-25°C~+70°C	Altitude	≤2000m
Terminal connection type	Cable/Busbar	Relative humidity	≤95%
Connectable conductor cross section	1-25mm <sup>2</sup>	Resistance to humidity and heat	Class 2
Mounting	IEC/EN 60715 top-hat rail 35mm	Installation class	III
Fastening torque of terminals	2-3.0N.m		

## ΔΙΑΚΟΠΤΗΣ ΔΙΑΡΡΟΗΣ ΤΥΠΟΥ AC

RESIDUAL CURRENT CIRCUIT BREAKER 30MA 6KA TYPE AC

CODE	AMPERAGE	MODULES	PACKING
500-37004	2X25A	2	6\60
500-37000	2X40A	2	6\60
500-37001	2X63A	2	6\60
500-37002	4X40A	2	3\30
500-37003	4X63A	2	3\30

## ΔΙΑΚΟΠΤΗΣ ΔΙΑΡΡΟΗΣ ΤΥΠΟΥ AC

RESIDUAL CURRENT CIRCUIT BREAKER 300MA 6KA TYPE AC

CODE	AMPERAGE	MODULES	PACKING
500-37010	2X40A	2	6\60
500-37012	4X40A	2	3\30
500-37013	4X63A	4	3\30

## ΔΙΑΚΟΠΤΗΣ ΔΙΑΡΡΟΗΣ ΤΥΠΟΥ A

RESIDUAL CURRENT CIRCUIT BREAKER 30MA 6KA TYPE A

CODE	AMPERAGE	MODULES	PACKING
500-37020	2X25A	2	6\60
500-37021	2X40A	2	6\60
500-37022	2X63A	2	6\60
500-37023	4X40A	4	3\30
500-37024	4X63A	4	3\30

ΡΕΛΕ ΔΙΑΡΡΟΗΣ ΜΕ ΣΤΟΙΧΕΙΑ ΜΙΚΡΟΑΥΤΟΜΑΤΟΥ  
RESIDUAL CURRENT CIRCUIT BREAKER WITH OVERLOAD PROTECTION

## PL8NT,4.5KA, RCBO

ELECTRONIC

- Ρελέ διαρροής με στοιχεία μικροαυτόματου σύμφωνα με το IEC/EN 61009-1
  - Ηλεκτρονικός τύπος
  - Ονομαστική ικανότητα διακοπής βραχυκυκλώματος 4.5kA
  - Έκδοση 1+N πόλων
  - Ρεύμα 30 mA και 300mA
  - Ονομαστικό ρεύμα έως 32A
  - Πλάτος 1 μονάδας
  - Τύποι AC και A
- Residual Current Circuit Breaker according to IEC/EN 61009-1
  - Electronic type
  - Rated short circuit breaking capacity 4.5kA
  - 1+N-pole version
  - Rated residual current 10, 30, 100, 300mA
  - Rated current up to 32A
  - 1-module width
  - AC and A types



Τα ρελέ διαρροής με στοιχεία μικροαυτόματου PL8NT βασίζονται σε συνδυασμό συσκευής υπολειπόμενου ρεύματος και διακόπτη κυκλώματος με απελευθέρωση υπερφόρτωσης θερμικά και απελευθέρωση βραχυκυκλώματος μαγνητικά. Χρησιμοποιούνται σε οικιακές, εμπορικές και βιομηχανικές εφαρμογές. Το RCBO βασίζεται σε συνδυασμό στοιχείων του ρελέ διαρροής και του μικροαυτόματου.

PL8NT residual current circuit breaker are based on combination of residual current device on the amplified signal of electronic components and circuit breaker with thermal overload release and magnetic short circuit current release. Usually used in domestic, commercial and industrial application.



### Product Tips

- 1 Neutral line interface
- 2 Contacts position indication window
- 3 Rated short circuit breaking capacity 4500A
- 4 Test button
- 5 Live line interface
- 6 Electronic circuit diagram with overload protection
- 7 Tripping characteristics B, C
- 8 Sensitivity to residual current AC



### Product Tips

- 1 Neutral line interface
- 2 Test button
- 3 Variants from 10 to 300mA  $I_{\Delta n}$  available
- 4 Electronic circuit diagram with overload protection
- 5 Busbar interface
- 6 Contacts position indication window
- 7 Sensitivity to residual current AC
- 8 Rated short circuit breaking capacity 4500A

## ELECTRICAL FEATURES

International standard	IEC/EN 61009-1
Poles	1P+N
Rated current	6-32A
Rated residual current $I_{\Delta n}$	30, 100, 300mA
Residual current protection type	Electronic
Conditional short circuit strength Inc	4.5kA
Rated operational voltage $U_e$	230/400V AC
Voltage range of the test button T	195.5 - 253V AC
Sensitivity to residual current	AC type - AC residual current / A type - residual AC & pulsating DC current
Rated frequency	50/60Hz
Rated insulated voltage $U_i$	400V AC
Rated impulse withstand voltage $U_{imp}$	4kV
Dielectric test voltage	2.5kV
Mechanical service life	10000 operation cycles
Electrical service life	4000 operation cycles
Time characteristic of RCD	Undelayed type

## INSTALLATION PARAMETERS

Degree of protection (IP)	IP20, IP40 (when fitted)
Operating ambient temperature	-250C~+700C
Terminal connection type	Cable/Busbar
Connectable conductor cross section	1-25mm <sup>2</sup>
Mounting	IEC/EN 60715 top-hat rail 35mm
Fastening torque of terminals	2-3.0N.m
Pollution degree	2
Altitude	≤2000m
Relative humidity	≤95%
Resistance to humidity and heat	Class 2
Installation class	III
Reference temperature for setting of thermal element	300C

**ΔΙΑΚΟΠΤΗΣ ΔΙΑΡΡΟΗΣ ΜΕ ΣΤΟΙΧΕΙΑ ΜΙΚΡΟΑΥΤΟΜΑΤΟΥ ΔΙΠΟΛΙΚΟΣ ΤΥΠΟΥ Α ΚΑΜΠΥΛΗ C**  
 RESIDUAL CIRCUIT BREAKER WITH OVERLOAD PROTECTION 1 MODULE 30MA 4.5KA 1P+N TYPE A CURVE C

CODE	AMPERAGE	MODULES	PACKING
500-43510	6A	1	12\120
500-43511	10A	1	12\120
500-43512	16A	1	12\120
500-43513	20A	1	12\120
500-43514	25A	1	12\120
500-43515	32A	1	12\120
500-43516	40A	1	12\120

**ΔΙΑΚΟΠΤΗΣ ΔΙΑΡΡΟΗΣ ΜΕ ΣΤΟΙΧΕΙΑ ΜΙΚΡΟΑΥΤΟΜΑΤΟΥ ΔΙΠΟΛΙΚΟΣ ΤΥΠΟΥ ΑC ΚΑΜΠΥΛΗ C**  
 RESIDUAL CIRCUIT BREAKER WITH OVERLOAD PROTECTION 30MA 4.5KA 1P+N TYPE AC CURVE C

CODE	AMPERAGE	MODULES	PACKING
500-43500	6A	2	6\60
500-43501	10A	2	6\60
500-43502	16A	2	6\60
500-43503	20A	2	6\60
500-43504	25A	2	6\60
500-43505	32A	2	6\60
500-43506	40A	2	6\60

ΡΕΛΕ ΔΙΑΡΡΟΗΣ ΜΕ ΣΤΟΙΧΕΙΑ ΜΙΚΡΟΑΥΤΟΜΑΤΟΥ  
RESIDUAL CURRENT CIRCUIT BREAKER WITH OVERLOAD PROTECTION

## PL8HE, 6KA, RCBO

ELECTRONIC

- Ρελέ διαρροής με στοιχεία μικροαυτόματου σύμφωνα με το IEC/EN 61009-1
- Ηλεκτρονικός τύπος
- Ονομαστική ικανότητα διακοπής βραχυκυκλώματος 6kA
- Έκδοση 1+N πόλων
- N-πόλος στα δεξιά
- Ονομαστικό υπολειπόμενο ρεύμα 30mA and 300mA
- Ονομαστικό ρεύμα έως 40A
- Πλάτος 2 μονάδων
- Τύποι AC και A

- Residual Current Circuit Breaker according to IEC/EN 61009-1
- Electronic type
- Rated short circuit breaking capacity 6kA
- 1+N-pole version
- N-pole on the right
- Rated residual current 10, 30, 100, 300mA
- Rated current up to 40A
- 2-module width
- AC and A types



Τα ρελέ διαρροής με στοιχεία μικροαυτόματου PL8NT βασίζονται σε συνδυασμό συσκευής υπολειπόμενου ρεύματος και διακόπτη κυκλώματος με απελευθέρωση υπερφόρτωσης θερμικά και απελευθέρωση βραχυκυκλώματος μαγνητικά. Χρησιμοποιούνται σε οικιακές, εμπορικές και βιομηχανικές εφαρμογές.

PL8HE residual current circuit breaker are based on combination of residual current device on the amplified signal of electronic components and circuit breaker with thermal overload release and magnetic short circuit current release. Usually used in domestic, commercial and industrial application.



### Product Tips

- 1 Neutral line interface
- 2 Contacts position indication window
- 3 Rated short circuit breaking capacity 4500A
- 4 Test button
- 5 Live line interface
- 6 Electronic circuit diagram with overload protection
- 7 Tripping characteristics B, C
- 8 Sensitivity to residual current AC



### Product Tips

- 1 Rated current up to 40A
- 2 Contacts position indication window
- 3 Rated short circuit breaking capacity 6000A
- 4 Sensitivity to residual current A
- 5 Busbar interface
- 6 Test button
- 7 Electronic circuit diagram with overload protection
- 8 Neutral line interface

## ELECTRICAL FEATURES

International standard	IEC/EN 61009-1	Sensitivity to residual current	AC type - AC residual current / A type - residual AC & pulsating DC current
Poles	1P+N	Rated frequency	50/60Hz
Tripping characteristics of MCB	B, C	Rated insulated voltage $U_i$	400V AC
Rated current	6-40A	Rated impulse withstand voltage $U_{imp}$	4kV
Rated residual current $I_{\Delta n}$	10, 30, 100, 300mA	Dielectric test voltage	2.5kV
Residual current protection type	Electronic	Mechanical service life	10000 operation cycles
Conditional short circuit strength $I_{nc}$	6kA	Electrical service life	4000 operation cycles
Rated operational voltage $U_e$	230/400V AC	Time characteristic of RCD	Undelayed type
Voltage range of the test button T	195.5 - 253V AC		

## INSTALLATION PARAMETERS

Degree of protection (IP)	IP20, IP40 (when fitted)	Pollution degree	2
Operating ambient temperature	-25°C...+70°C	Altitude	≤2000m
Terminal connection type	Cable/Busbar	Relative humidity	≤95%
Connectable conductor cross section	1-25mm <sup>2</sup>	Resistance to humidity and heat	Class 2
Mounting	IEC/EN 60715 top-hat rail 35mm	Installation class	III
Fastening torque of terminals	2-3.0N.m	Reference temperature for setting of thermal element	30°C

### ΔΙΑΚΟΠΤΗΣ ΔΙΑΡΡΟΗΣ ΜΕ ΣΤΟΙΧΕΙΑ ΜΙΚΡΟΑΥΤΟΜΑΤΟΥ ΜΟΝΟΠΟΛΙΚΟΣ ΤΥΠΟΥ AC ΚΑΜΠΥΛΗ C RESIDUAL CIRCUIT BREAKER WITH OVERLOAD PROTECTION 30MA 6KA 1P+N TYPE AC CURVE C

CODE	AMPERAGE	MODULES	PACKING
500-43530	6A	1	12\120
500-43531	10A	1	12\120
500-43532	16A	1	12\120
500-43533	20A	1	12\120
500-43534	25A	1	12\120
500-43535	32A	1	12\120
500-43536	40A	1	12\120

### ΔΙΑΚΟΠΤΗΣ ΔΙΑΡΡΟΗΣ ΜΕ ΣΤΟΙΧΕΙΑ ΜΙΚΡΟΑΥΤΟΜΑΤΟΥ ΔΙΠΟΛΙΚΟΣ ΤΥΠΟΥ AC C RESIDUAL CIRCUIT BREAKER WITH OVERLOAD PROTECTION 30MA 6KA 1P+N TYPE AC CURVE C

CODE	AMPERAGE	MODULES	PACKING
500-43520	6A	2	6\60
500-43521	10A	2	6\60
500-43522	16A	2	6\60
500-43523	20A	2	6\60
500-43524	25A	2	6\60
500-43525	32A	2	6\60
500-43526	40A	2	6\60

### ΔΙΑΚΟΠΤΗΣ ΔΙΑΡΡΟΗΣ ΜΕ ΣΤΟΙΧΕΙΑ ΜΙΚΡΟΑΥΤΟΜΑΤΟΥ ΜΟΝΟΠΟΛΙΚΟΣ B ΤΥΠΟΥ AC RESIDUAL CIRCUIT BREAKER WITH OVERLOAD PROTECTION 30MA 6KA 1P+N CURVE B TYPE AC

CODE	AMPERAGE	MODULES	PACKING
500-43550	6A	1	12\120
500-43551	10A	1	12\120
500-43552	16A	1	12\120
500-43553	20A	1	12\120
500-43554	25A	1	12\120
500-43555	32A	1	12\120
500-43556	40A	1	12\120

### ΔΙΑΚΟΠΤΗΣ ΔΙΑΡΡΟΗΣ ΜΕ ΣΤΟΙΧΕΙΑ ΜΙΚΡΟΑΥΤΟΜΑΤΟΥ ΔΙΠΟΛΙΚΟΣ B ΤΥΠΟΥ AC RESIDUAL CIRCUIT BREAKER WITH OVERLOAD PROTECTION 30MA 6KA 1P+N CURVE B TYPE AC

CODE	AMPERAGE	MODULES	PACKING
500-43540	6A	2	6\60
500-43541	10A	2	6\60
500-43542	16A	2	6\60
500-43543	20A	2	6\60
500-43544	25A	2	6\60
500-43545	32A	2	6\60
500-43546	40A	2	6\60

## ΔΙΑΚΟΠΤΗΣ ΔΙΑΡΡΟΗΣ ΜΕ ΣΤΟΙΧΕΙΑ ΜΙΚΡΟΑΥΤΟΜΑΤΟΥ RESIDUAL CURRENT CIRCUIT BREAKER WITH OVERLOAD PROTECTION

### PL8M4, 6kA, RCBO

ELECTOMAGNETIC

- Ρελέ διαρροής με στοιχεία μικροαυτόματου σύμφωνα με το IEC/EN 61009-1
  - Ηλεκτρομαγνητικός τύπος
  - Κανονική ικανότητα διακοπής βραχυκυκλώματος 6kA
  - Έκδοση 3+N πόλων
  - Ουδέτερος "N" πόλος στα δεξιά
  - Κανονικό υπολειμματικό ρεύμα 30mA και 300mA
  - Κανονικό ρεύμα έως 40A
  - Πλάτος 4 στοιχείων
  - Τύποι AC και A
- Residual Current Circuit Breaker according to IEC/EN 61009-1
  - Electromagnetic type
  - Rated short circuit breaking capacity 6kA
  - 3+N-pole version
  - N-pole on the right
  - Rated residual current 10, 30, 100, 300mA
  - Rated current up to 40A
  - 4-module width
  - AC and A types



Τα ρελέ διαρροής με στοιχεία μικροαυτόματου PL8M4 βασίζονται σε συνδυασμό συσκευής υπολειπόμενου ρεύματος και διακόπτη κυκλώματος με απελευθέρωση υπερφόρτωσης θερμικά και απελευθέρωση βραχυκυκλώματος μαγνητικά. Χρησιμοποιούνται σε οικιακές, εμπορικές και βιομηχανικές εφαρμογές.

PL8M4 residual current circuit breaker are based on combination of residual current device on the amplified signal of electronic components and circuit breaker with thermal overload release and magnetic short circuit current release. Usually used in domestic, commercial and industrial application.

#### Product Tips

- 1 Neutral line interface
- 2 Rated current up to 40A
- 3 Electromagnetic circuit diagram with overload protection
- 4 Test button
- 5 Busbar interface
- 6 Sensitivity to residual current A
- 7 Contacts position indication window
- 8 Rated short circuit breaking capacity 6000A

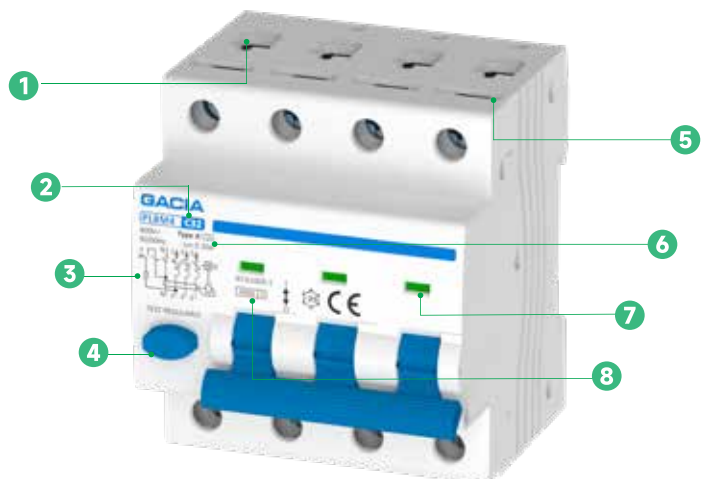

## ELECTRICAL FEATURES

International standard	IEC/EN 61009-1	Sensitivity to residual current	AC type - AC residual current / A type - residual AC & pulsating DC current
Poles	3P+N	Rated frequency	50/60Hz
Tripping characteristics of MCB	B, C	Rated insulated voltage $U_i$	400V AC
Rated current	6-40A	Rated impulse withstand voltage $U_{imp}$	4kV
Rated residual current $I_{\Delta n}$	10, 30, 100, 300mA	Dielectric test voltage	2.5kV
Residual current protection type	Electromagnetic	Mechanical service life	10000 operation cycles
Conditional short circuit strength $I_{nc}$	6kA	Electrical service life	4000 operation cycles
Rated operational voltage $U_e$	230/400V AC	Time characteristic of RCD	Undelayed type
Voltage range of the test button T	195.5 - 253V AC		

## INSTALLATION PARAMETERS

Degree of protection (IP)	IP20, IP40 (when fitted)	Pollution degree	2
Operating ambient temperature	-25°C~+70°C	Altitude	≤2000m
Terminal connection type	Cable/Busbar	Relative humidity	≤95%
Connectable conductor cross section	1-25mm <sup>2</sup>	Resistance to humidity and heat	Class 2
Mounting	IEC/EN 60715 top-hat rail 35mm	Installation class	III
Fastening torque of terminals	2-3.0N.m	Reference temperature for setting of thermal element	30°C

## ΔΙΑΚΟΠΤΗΣ ΔΙΑΡΡΩΣΗΣ ΜΕ ΣΤΟΙΧΕΙΑ ΜΙΚΡΟΑΥΤΟΜΑΤΟΥ ΤΕΤΡΑΠΟΛΙΚΟΣ ΤΥΠΟΥ Α ΚΑΜΠΥΛΗ C RESIDUAL CIRCUIT BREAKER WITH OVERLOAD PROTECTION 30MA 6KA 3P+N TYPE A CURVE C

CODE	AMPERAGE	MODULES	PACKING
500-43560	6A	4	3\30
500-43561	10A	4	3\30
500-43562	16A	4	3\30
500-43563	20A	4	3\30
500-43564	25A	4	3\30
500-43565	32A	4	3\30
500-43566	40A	4	3\30

## ΔΙΑΚΟΠΤΗΣ ΔΙΑΡΡΩΣΗΣ ΜΕ ΣΤΟΙΧΕΙΑ ΜΙΚΡΟΑΥΤΟΜΑΤΟΥ ΔΙΠΟΛΙΚΟΣ ΤΥΠΟΥ Α ΚΑΜΠΥΛΗ C RESIDUAL CIRCUIT BREAKER WITH OVERLOAD PROTECTION 10MA 6KA 1P+N TYPE A CURVE C

CODE	AMPERAGE	MODULES	PACKING
500-45300	20A	2	6\60
500-45301	40A	2	6\60

## ΔΙΑΚΟΠΤΗΣ ΔΙΑΡΡΩΣΗΣ ΜΕ ΣΤΟΙΧΕΙΑ ΜΙΚΡΟΑΥΤΟΜΑΤΟΥ ΤΕΤΡΑΠΟΛΙΚΟΣ ΤΥΠΟΥ Α ΚΑΜΠΥΛΗ C RESIDUAL CIRCUIT BREAKER WITH OVERLOAD PROTECTION 100MA 6KA 3P+N TYPE A CURVE C

CODE	AMPERAGE	MODULES	PACKING
500-45302	20A	4	3\30
500-45303	40A	4	3\30

## ΡΑΓΟΔΙΑΚΟΠΤΕΣ ΔΕΗ

### DZ47,6KA

- Μικροαυτόματοι σύμφωνα με το IEC/EN 60947-2
  - Ονομαστική διακοπή βραχυκυκλώματος 6kA
  - Διαθέσιμοι από εκδόσεις 1 έως 4 πόλων
  - Χαρακτηριστικά βραχυκύκλωσης 8-12In
  - Ονομαστικό ρεύμα έως 125A
  - Ονομαστική τάση λειτουργίας 230/400V AC
- Miniature Circuit Breakers according to IEC/EN 60947-2
  - Rated short circuit breaking capacity 6kA
  - 1 up to 4-pole versions
  - Tripping characteristics 8-12In
  - Rated current up to 125A
  - Rated operational voltage 230/400V AC



Ο μικροαυτόματος SG6H είναι κατάλληλος κυρίως για εφαρμογές διανομής ισχύος και βιομηχανικές εφαρμογές για προστασία από βραχυκύκλωμα και ρεύμα υπερφόρτωσης με ονομαστικό ρεύμα έως 125 A και πολύ υψηλές ονομαστικές ικανότητες διακοπής (δοκιμασμένος σύμφωνα με το EN 60947-2). Μπορεί επίσης να χρησιμοποιηθεί για μη συχνές λειτουργίες ενεργοποίησης και απενεργοποίησης υπό κανονικές συνθήκες.

SG6H Miniature Circuit Breaker is suitable mainly for power distribution and industrial applications for short-circuit and overload current protection with rated current up to 125 A and a very high rated breaking capacities (tested according to EN 60947-2). It also can be used for non-frequent on-and-off switching operations under normal circumstances.

### Product Tips

- 1 Reversible line and load connection
- 2 Rated current up to 125A
- 3 International standards
- 4 Rated short circuit breaking capacity 6000A
- 5 Modifiable modules for ODM clients
- 6 Contacts position indication window
- 7 The position of handle lock

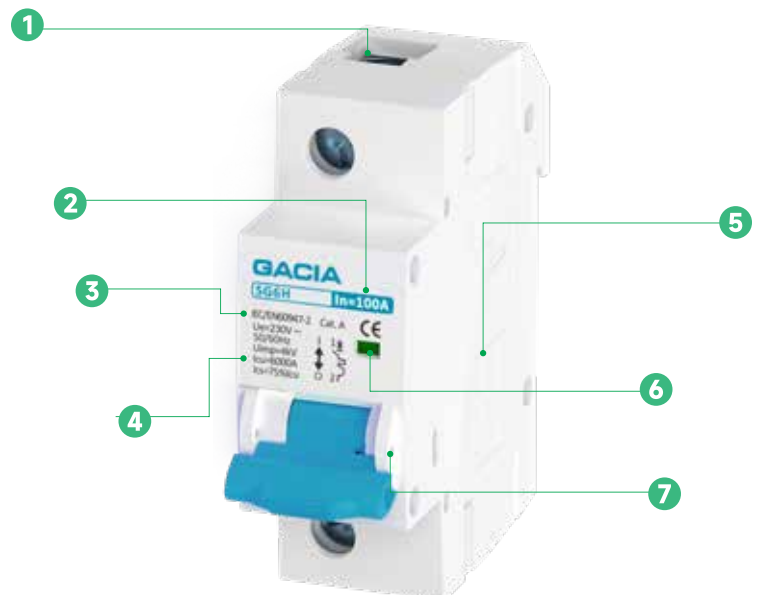

## ELECTRICAL FEATURES

International standard	IEC/EN 60947-2	Rated insulated voltage $U_i$	500V AC
Poles	1P, 2P, 3P, 4P	Rated impulse withstand voltage $U_{imp}$	6kV
Tripping characteristics	8-12In	Dielectric test voltage	2kV
Rated current	16-125A	Mechanical service life	10000 operation cycles
Rated breaking capacity $I_{cn}$	6kA	Electrical service life	4000 operation cycles
Rated operational voltage $U_e$	230/400V AC	Line voltage connection	Arbitrary above or below
Minimum operational voltage $U_{min}$	12V AC		
Maximum operational voltage $U_{max}$	440V AC		
Rated frequency	50/60Hz		

## INSTALLATION PARAMETERS

Degree of protection (IP)	IP20, IP40 (when fitted)	Pollution degree	2
Operating ambient temperature	-25°C~+70°C	Altitude	≤2000m
Terminal connection type	Cable	Relative humidity	≤95%
Connectable conductor cross section	2.5-50mm <sup>2</sup>	Resistance to humidity and heat	Class 2
Mounting	IEC/EN 60715 top-hat rail 35mm	Installation class	III
Fastening torque of terminals	2-3.5N.m	Reference temperature for setting of thermal element	30°C

## ΔΙΑΚΟΠΤΗΣ ΔΙΑΡΡΩΣΗΣ ΜΕ ΣΤΟΙΧΕΙΑ ΜΙΚΡΟΑΥΤΟΜΑΤΟΥ ΤΕΤΡΑΠΟΛΙΚΟΣ ΤΥΠΟΥ A RESIDUAL CIRCUIT BREAKER WITH OVERLOAD PROTECTION 30MA 6KA 3P+N TYPE A

CODE	AMPERAGE	MODULES	PACKING
500-42154	1X25A	1	12\120
500-42150	1X40A	1	12\120
500-42151	1X63A	1	12\120
500-42155	1X100A	1	8\80
500-42156	3X25A	3	4\40
500-42152	3X40A	3	4\40
500-42153	3X63A	3	4\40



## ΛΥΧΝΙΕΣ ΡΑΓΑΣ

### DIN RAIL INDICATOR LIGHT

#### Applications

- Indication of signal
- Pre-set signal
- Malfunction signal in electric system

#### Technical Information

- Rated Insulation voltage(Ui) 500V;
- Electrical endurance: LED>10000h
- Basic color of the signal lights: red,green,blue,yellow,white
- Rated operational voltage: AC/DC 6.3V, AC/DC12V, AC/DC 24V, AC/DC 110V, AC/DC 230V;
- Rated Insulation voltage(Ui) 500V;
- Degree of protection: IP20



### ΕΝΔΕΙΚΤΙΚΕΣ ΛΥΧΝΙΕΣ ΡΑΓΑΣ

#### DIN RAIL INDICATOR LIGHT

CODE	DESCRIPTION	MODULES	PACKING
500-39001	LED SLIM ΚΟΚΚΙΝΗ / LED SLIM RED AC240	1/2	24\240
500-39002	LED SLIM ΠΡΑΣΙΝΗ / LED SLIM GREEN AC240	1/2	24\240
500-39003	LED SLIM ΜΠΛΕ / LED SLIM BLUE AC240	1/2	24\240
500-39005	ΤΡΙΦΑΣΙΚΗ LED 220V/3 PHASE LED 220V	1	1\12\240

## ΑΦΑΛΕΙΟΘΗΚΕΣ ΓΙΑ ΚΥΛΙΝΔΡΙΚΑ ΦΥΣΙΓΓΙΑ 10x38

### DIN RAIL FUSE CARRIERS 10X38

#### Εφαρμογές / Applications

- Για να συγχωνευθεί και να διακόψει το κύκλωμα, προκειμένου να προστατεύσει το κύκλωμα από ασυνήθιστο ρεύμα.  
To fuse itself to cut off the circuit so as to protect the circuit in the abnormal current
- Βάση σειράς FS / FS series base
- Συμμορφώνεται με τα πρότυπα GB13539, IEC60269 / It conforms to GB13539,IEC60269 Standard
- Εγκατάσταση σε ράγα DIN / Din rail installation: 35mm
- Κατάλληλες διαστάσεις εγκατάστασης / Suitable installation dimensions: Ø10 x 38
- AC-DC



#### Technical Information

##### Φ10X38 FUSE CARRIERS. 1P, 2P, 3P,4P STANDARD DIN RAIL INSTALLATION

- Rated voltage 500V - 1000V
- Rated Current 32A
- Type FS32

### ΑΣΦΑΛΕΙΟΘΗΚΕΣ

#### DIN RAIL FUSE CARRIERS

CODE	DESCRIPTION	MODULES	PACKING	PRICE (€)	CODE	DESCRIPTION	MODULES	PACKING
500-22000	1P 10X38 6-32A	1	12\120	2.82	500-22001	3P 10X38 6-32A	3	4\40
500-22005	2P 10X38 6-32A	2	6\120	6.25	500-22012	4P 14X51 6-32A	4	1\27

### ΑΣΦΑΛΕΙΟΘΗΚΕΣ DC

#### DIN RAIL FUSE CARRIERS DC

CODE	DESCRIPTION	MODULES	PACKING
500-22002	DC STI-32 10X38 500VDC 2P	2	6\60
500-22003	DC STI-32 10X38 500VDC 3PN	3	4\40
500-22004	DC STI-32 10X38 1000VDC 2P	2	6\60

## ΧΡΟΝΟΔΙΑΚΟΠΤΗΣ ΡΑΓΑΣ ΑΥΤΟΜΑΤΟΣ ΚΛΙΜΑΚΟΣΤΑΣΙΟΥ

AUTOMATIC TIMER STAIR CASE



147-64000

147-35010

### ΧΡΟΝΟΔΙΑΚΟΠΤΕΣ ΜΕ ΕΦΕΔΡΕΙΑ TIMER SWITCH WITH RESERVE

CODE	DESCRIPTION	MODULES	PACKING
147-35010	16A 110-250V 100h	1	12\120

### ΑΥΤΟΜΑΤΟΣ ΚΛΙΜΑΚΟΣΤΑΣΙΟΥ AUTOMATIC TIMER STAIR CASE

CODE	DESCRIPTION	MODULES	PACKING
147-64000	16A 230V AC	1	12\120

## ΧΡΟΝΟΔΙΑΚΟΠΤΗΣ ΡΑΓΑΣ 2 ΣΤΟΙΧΕΙΩΝ ΨΗΦΙΑΚΟΣ TIMER SWITCH 2 MODULE DIGITAL

- Production Material Plastic & ABS • Voltage: 230V 50/60Hz
- Amperage: 20A • 24 ώρες Δυνατότητα Ρύθμισης / 24 hours Adjustable Time
- 150 ώρες Αυτονομία / 150 hours Discharge Time



Code	Barcode	Watt	Dimensions(mm)	Packing	MOQ
147-35011	5207227013324	max 200W	86x36x66	1/100	1

## ΠΡΙΖΑ ΣΟΥΚΟ ΡΑΓΑΣ DIN RAIL MOUNTED SOCKET

### Applications

To provide a convenient power supply interface for the electrical equipment.

### Ηλεκτρικά χαρακτηριστικά / Electrical features

- Ονομαστικό ρεύμα / Rated current In 10 16 25A
- Poles 2-3
- Ονομαστική τάση / Rated voltage Ue 250V
- Διατομή αγωγού / Cross sectional area of the conducting wire 16mm<sup>2</sup>
- Βαθμός προστασίας / Degree of protection IP20
- Θερμοκρασία περιβάλλοντος / Ambient air temperature -25°C + 55°C
- Απόδοση βύσματος / Plug performance 5000 times



### ΠΡΙΖΑ ΣΟΥΚΟ ΡΑΓΑΣ SOCKET

CODE	DESCRIPTION	MODULES	PACKING
500-16000	16A	2	1\100

## ΡΕΛΕ ΙΣΧΥΟΣ ΡΑΓΑΣ

### DIN RAIL MODULAR CONTACTOR

#### Εφαρμογές / Applications

- Electric ratings: up to 25A,40A,63A,100A
- Standard: IEC/EN61095
- HC-225/HC-240/HC-263:  $U_e=230V\sim$
- $U_i:500V$
- Utilization category: AC-1, AC-7a, AC-7b
- Electrical life 100000, Mechanical life 1000000
- HC-425/HC-440/HC-463:  $U_e=400V\sim$
- Operation Range

Το ρελέ ισχύος πρέπει να ενεργοποιείται αξιόπιστα σε οποιαδήποτε τιμή μεταξύ 85%  $U_s$  και 110%  $U_s$ . Το 110%  $U_s$  είναι η μέγιστη τιμή και το 85%  $U_s$  είναι η ελάχιστη τιμή. Το ρελέ ισχύος να απελευθερώνεται και να διακόπτεται πλήρως μεταξύ 75%  $U_s$  και 20%  $U_s$ . Το 20%  $U_s$  είναι η μέγιστη τιμή και το 75%  $U_s$  είναι η ελάχιστη τιμή.

Contactors shall pull in reliably at any value between 85%  $U_s$  and 110%  $U_s$ . 110%  $U_s$  is the maximum value and 85%  $U_s$  is the minimum value. Contactors shall release and break completely between 75%  $U_s$  and 20%  $U_s$ . 20%  $U_s$  is the maximum value and 75%  $U_s$  is the minimum value.

- Τα ρελέ ισχύος είναι μονάδες ελέγχου με νέα δομή και μικρό όγκο. Χαρακτηριστικά περιλαμβάνουν εγκατάσταση σε ράγα DIN, μέγεθος σε μονάδες, όμορφο σχέδιο και ασφάλεια. Μπορούν να εφαρμόσουν αναστρέψιμη δομή και να συνδυαστούν με μικροαυτόματα ράγας.  
Contactors are modular control appliances of novel structure, small volume. Its characteristic includes din-rail installation, modular size, beautiful design, and safety. It can apply inversion structure and be combined with mini circuit breaker in lighting box.
- Χρησιμοποιούν καλό υλικό μόνωσης, το οποίο βελτιώνει το δείκτη ασφαλείας.  
It applies good insulation material, which improves the safety index.
- Διαθέτουν καλό φινιρίσμα και χαμηλό θόρυβο, κατάλληλοι για ξενοδοχεία, νοσοκομεία κ.λπ.  
It has good appearance and low noise and is suitable for hotel and hospital, etc.



#### ΡΕΛΕ ΙΣΧΥΟΣ ΡΑΓΑΣ 220V DIN RAIL MODULAR CONTACTOR 220V

CODE	DESCRIPTION	MODULES	PACKING
500-37100	2X20A 2NO	1	12\120
500-37101	2X40A 2NO	1 1/2	12\120
500-37102	2X63A 2NO	1 1/2	12\120
500-37110	4X25A 4NO	2	4\40
500-37111	4X40A 4NO	3	3\30
500-37112	4X63A 4NO	3	3\30

#### ΡΕΛΕ ΙΣΧΥΟΣ ΡΑΓΑΣ 24V DIN RAIL MODULAR CONTACTOR 24V

CODE	DESCRIPTION	MODULES	PACKING
500-37120	2X25A 2NO	1	12\120
500-37121	2X40A 2NO	1 1/2	12\120
500-37122	2X63A 2NO	1 1/2	12\120
500-37123	4X25A 4NO	2	4\40
500-37124	4X40A 4NO	3	3\30
500-37125	4X63A 4NO	3	3\30

## ΡΕΛΕ ΙΣΧΥΟΣ ΡΑΓΑΣ WiFi

### MODULAR CONTACTOR WiFi

#### Applications

- Electric ratings: up to 50A,63A
- Standard: EN 60898-1:2018
- Supply Voltage: 220V
- Electrical life 1000000, Mechanical life 1000000
- Use through the Eurolamp application
- It applies good insulating material, which improves the safety index

SMART  
RELE



#### ΡΕΛΕ ΙΣΧΥΟΣ ΡΑΓΑΣ WiFi DIN RAIL MODULAR CONTACTOR WiFi

CODE	DESCRIPTION	MODULES	PACKING
500-37150	WiFi 2X50A 240V 1P AC EUROLAMP	1	1\100
500-37151	WiFi 2X63A 240V 2P AC EUROLAMP	2	1\50

## ΜΕΤΡΗΤΕΣ ΡΕΥΜΑΤΟΣ ΡΑΓΑΣ DIN RAIL ELECTRIC METERS



**ANALOG**  
1 PHASE  
• **Voltage**  
220-240V 50/60Hz  
• **Production Material**  
Plastic & ABS

147-02063 147-02062



**DIGITAL**  
1 PHASE  
• **Voltage**  
220-240V 50/60Hz  
• **Production Material**  
Plastic & ABS

147-02065 147-02064



**DIGITAL**  
3 PHASE  
• **Voltage**  
400V 50/60Hz  
• **Production Material**  
Plastic & ABS

147-02057

Code	Barcode	Ampere	Dimensions(mm)	Packing	MOQ
ΜΕΤΡΗΤΗΣ ΡΑΓΑΣ ΜΟΝΟΦΑΣΙΚΟΣ / 1 PHASE DIN RAIL METER					
147-02062	5207227548840	45A	17x91x60	10\100	1
147-02063	5207227548871	100A	73x85x48	1\60	1
ΜΕΤΡΗΤΗΣ ΡΑΓΑΣ ΨΗΦΙΑΚΟΣ ΜΟΝΟΦΑΣΙΚΟΣ / 1 PHASE DIN RAIL METER DIGITAL					
147-02064	5207227548895	45A	17x91x60	10\100	1
147-02065	5207227548925	100A	73x100x62	1\60	1
ΜΕΤΡΗΤΗΣ ΡΑΓΑΣ ΨΗΦΙΑΚΟΣ ΤΡΙΦΑΣΙΚΟΣ / 3 PHASE DIN RAIL METER DIGITAL					
147-02057	5206139210074	100A	122x100x63	1\32	1

## ΨΗΦΙΑΚΟΣ ΜΕΤΡΗΤΗΣ ΡΕΥΜΑΤΟΣ ΡΑΓΑΣ WiFi DIN RAIL DIGITAL METER WiFi

### Features

- Remote control
- Voice control
- Timing schedule
- Electricity metering
- Over/Under voltage protection
- Residual Current (leakage) protection
- Device sharing

### Applications / Supported Platforms



Smart Life



Tuya Smart



Google Assistant



Amazon Alexa



147-02066



147-02067

## ΨΗΦΙΑΚΟΣ ΜΕΤΡΗΤΗΣ ΡΕΥΜΑΤΟΣ ΡΑΓΑΣ WiFi DIN RAIL DIGITAL METER WiFi

CODE	Barcode	Description	Modules	Packing
147-02066	5207227558528	WiFi 63A 100-290V 1 PHASE AC	1	1\100
147-02067	5207227558542	WiFi 100A 100-290V 3 PHASE AC	1	1\100

NEW

# ΑΝΤΙΚΕΡΑΥΝΙΚΑ ΡΑΓΑΣ

DIN RAIL SURGE PROTECTIVE  
DEVICES



## Εφαρμογές / Applications

Ο SPD (Συσκευή Προστασίας Από Υπερτάσεις) είναι η σειρά συσκευών για εκφόρτιση επαγόμενων παροδικών υπερτάσεων (Τύπος 3 / Κατηγορία III), σύμφωνα με το πρότυπο EN/IEC 61643-11. Κατάλληλο για ράγα DIN. Παρέχει τη δυνατότητα εκφόρτισης επαγόμενων υπερτάσεων τάσης (8/20 μs). Προορίζεται για εξαιρετικά λεπτή προστασία ευαίσθητου εξοπλισμού (1.2/50 μs). Η εγκατάστασή του γίνεται μετά από προστασία τύπου 2.

SPD is the range of devices for discharging induced transient overvoltages (Type 3 / Class III), in accordance with EN/IEC 61643-11. DIN rail plug-in format. Ability to discharge induced voltage surges (8/20 v s). For very fine protection of sensitive equipment(1.2/50 p s). Installation downstream of type 2 protection.

- Suitable as the final stage of protection in panels with Type 2 protection devices installed upstream. The residual voltage left downstream is less than for Type 1 or 2. They should be installed as close as possible to the equipment being protected.
- Discharge capacity with an 8/20 μs waveform. I<sub>max</sub>: 10 kA.
- Exclusive devices for TNS, TNC, TT, IT earthing systems.
- Exclusive devices which are compatible with Power Line Communication networks.
- Biconnect - two types of terminal: for rigid or flexible cable and for fork type comb busbar.
- Available with optional remote signalling.
- AC/DC distribution
- Power supplies
- Industrial automation
- Telecommunications
- Motor controls systemsw
- PLC applications
- Power transfer equipment
- HVAC applications
- AC drives
- UPS systems
- Security systems
- IT / Data centers
- Medical equipment
- Easy installation or retrofit
- Din-rail mountable
- Fail-safe /self-protected design
- Remote indicator (optional) with 3 pin NO/NC contact
- IP20 finger-safe design
- Visual indicator
- Small foot print

## TECHNICAL DATA T1-T2-T3 275 / 320 / 385 / 420V

TYPE	SPD	TYPE	SPD
Maximum continuous voltage (U) (L-N) C	275V	Operating State/Fault Indication	IP 20
Maximum continuous voltage (U) (N-PE) C	Type 3	Degree of protection	PA66,UL94 V-0
SPD to EN 61643-11	class III	Insulating material / flammability class	-40°C--+80°C
SPD to IEC 61643-11	5kA	Temperature range	13123 ft [4000m]
Nominal discharge current (8/20μs) (I) n	10kA	Altitude	35mm2 (Solid) / 25mm2 (Flexible)
Maximum discharge current (8/20μs)(I) max	≤ 1.0 / 1.1/ 1.3 / 1.5kV	Conductor Cross Section (max)	Optional
Voltage protection level (U) (L-N) p	≤ 1.5kV	Remote Contacts (RC)	Pluggable
Voltage protection level (U) (N-PE) p	< 25ns	Format	DIN rail 35mm
Response time (t) (L-N) A	< 100ns	For mounting on	indoor installation
Response time (t) (N-PE) A	YES	Place of installation	18 36
Thermal Protection	Green (good) / White or Red replace)		

## ΑΝΤΙΚΕΡΑΥΝΙΚΑ T1-T2-T3 DIN RAIL SURGE PROTECTIVE DEVICE

CODE	DESCRIPTION	MODULES	PACKING
500-22202	T2 20kA-40kA 275V 2P GACIA	2	1\80
500-22203	T1-T2 12.5kA 275V 1P+NPE GACIA	2	1\132
500-22204	T2 20kA-40kA 385V 4P GACIA	4	1\40
500-22216	T2 20kA-40kA 275V 2P EUROLAMP	2	1\80
500-22217	T1-T2 12.5kA 275V 1P+NPE EUROLAMP	2	1\132
500-22211	T2 20kA-40kA 385V 4P EUROLAMP	4	1\40
500-22213	T1-T2 20kA-40kA 385V 4P EUROLAMP	4	1\40

## ΑΝΤΙΚΕΡΑΥΝΙΚΑ T1-T2-T3 DC (SOLAR) DIN RAIL SURGE PROTECTIVE DEVICE DC (SOLAR)

CODE	DESCRIPTION	MODULES	PACKING
500-22220	DC PV50 1000V T1+T2 12.5kA	2	12\120

# ΑΥΤΟΜΑΤΟΣ ΔΙΑΚΟΠΤΗΣ ΙΣΧΥΟΣ MOLDED CASE CIRCUIT BREAKER MCCB AC



GACIA

## Technical data and performance

The basic parameters are shown in the following tables

NEW

### ΓΕΝΙΚΟΣ ΔΙΑΚΟΠΤΗΣ ΙΣΧΥΟΣ AC CIRCUIT BREAKER AC

CODE	DESCRIPTION	PACKING
500-43640	MCCB 64-160A	1\1
500-43641	MCCB 200-250A	1\1
500-43642	MCCB 160-400A	1\1

# ΓΕΦΥΡΕΣ ΧΑΛΚΟΥ ΜΕ ΜΟΝΩΣΗ

INSULATED DISTRIBUTION BUSHBAR

## Εφαρμογές / Applications

Οι γέφυρες χαλκού (Distribution Busbar) άλλαξαν τους παλιούς τρόπους σύνδεσης των μικροαυτόματων ράγας (MCB) με έναν νέο τρόπο σύνδεσης, ο οποίος διαθέτει χαρακτηριστικά όπως μεγαλύτερη περιοχή επαφής και χαμηλή αύξηση θερμοκρασίας. Η GACIA προσφέρει σχεδόν όλες τις γέφυρες για MCB, τα οποία έχουν καλή ευχρηστία και πρακτικότητα. Διαθέτει πλεονεκτήματα ασφαλείας και ευκολίας στην εγκατάσταση.

The Present of Distribution Busbar changed the outdated connection ways of Miniature circuit breaker(MCB)to a new connection waywith the characteristics of wider contact area, low power consumption and low temperature-rise.

GACIA provide almost all kinds of busbars for MCB,which have good versatility and practibility.It has advantages of security and convenience to install and widely used in construction electrical devices such as low-voltage power box, distribution box, illuminated box and so on.



500-10000 / 500-10001



500-10002 / 500-10003



500-10004 / 500-10005



500-10006 / 500-10007



500-10020 / 500-10021



500-10022 / 500-10023



500-10024 / 500-10025

## ΓΕΦΥΡΕΣ ΧΑΛΚΟΥ ΜΕ ΜΟΝΩΣΗ ΤΥΠΟΥ L BUSHBAR COPPER WITH INSULATION TYPE L

CODE	DESCRIPTION	AMPERAGE	PACKING
500-10000	L 1P 12Ø	63A	1\500
500-10001	L 1P 1m	63A	1\100
500-10002	L 2P 12Ø	63A	1\250
500-10003	L 2P 1m	63A	1\50
500-10004	L 3P 12Ø	63A	1\200
500-10005	L 3P 1m	63A	1\50
500-10006	L 4P 12Ø	63A	1\120
500-10007	L 4P 1m	63A	1\30
500-10020	L L+N (1P) 12Ø	70A	1\150
500-10021	L DPN LN (1P) 1m	70A	1\50
500-10022	LDPN L 3P L1NL2NL3N (1P) 12Ø	70A	1\100
500-10023	L DPN 3P L1NL2NL3N (1P) 1m	70A	1\25
500-10024	L 3P L1NL2NL3N (2P) 12Ø	80A	1\120
500-10025	L 3P L1NL2NL3N (2P) 1m	80A	1\30

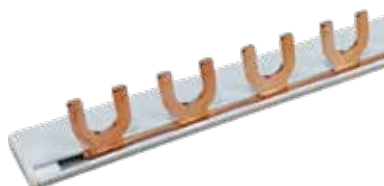
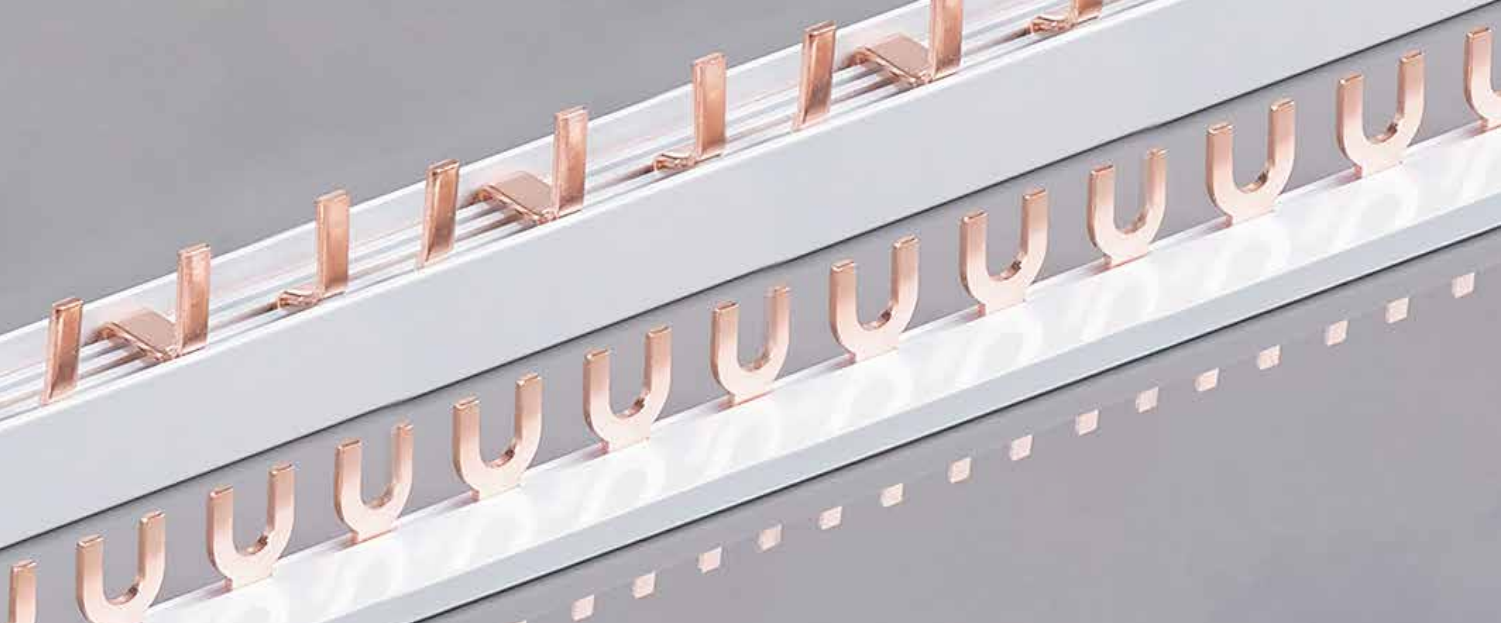

500-10010 / 500-10011



500-10012 / 500-10013



500-10014 / 500-10015



500-10016 / 500-10017



500-10026 / 500-10027

### ΓΕΦΥΡΕΣ ΧΑΛΚΟΥ ΜΕ ΜΟΝΩΣΗ ΤΥΠΟΥ U BUSHBAR COPPER WITH INSULATION TYPE U

CODE	DESCRIPTION	AMPERAGE	PACKING
500-10010	U 1P 12Ø	63A	1\500
500-10011	U 1P 1m	63A	1\100
500-10012	U 2P 12Ø	63A	1\250
500-10013	U 2P 1m	63A	1\50
500-10014	U 3P 12Ø	63A	1\200
500-10015	U 3P 1m	63A	1\50
500-10016	U 4P 12Ø	63A	1\120
500-10017	U 4P 1m	63A	1\30
500-10026	U L1NL2NL3N (2P) 12Ø	80A	1\120
500-10027	U L1NL2NL3N (2P) 1m	80A	1\30

## ΡΕΛΕ ΔΙΑΡΡΟΗΣ DC

RESIDUAL CIRCUIT BREAKER

## B TYPE RCCB



### ELECTRICAL FEATURES

Standard	IEC/EN61008-1 IEC/EN62423
Certification	CE, KEMA, CB
Rated voltage $U_n$	240V 1P+N; 415V 3P+N
Rated current $I_n$	25A,40A,63A
Rated residual operated current $I_{\Delta n}$	0.03A
Poles	2P,4P
Type of residual current	Type B (AC+A+smoothing DC+F+high frequency signal 1K Hz)
Rated limited short circuit current $I_{nc}$	10000A
Rated making and breaking capacity $I_m$	630A
Rated insulation voltage $U_i$	500V
Rated impulse withstand voltage $U_{imp}$	4000V
Electrical life	1000 times
Mechanical life	2000 times
Operated ambient temperature $0C$	- 250C~ +400C
Stored ambient temperature $0C$	- 250C~ +700C
Tightening torque	3N.M
Connection capacity	16mm <sup>2</sup>
Polution level	IP20
Protection level	2
Mounting type	

## ΥΛΙΚΑ ΠΙΝΑΚΩΝ DC

DC DIN RAIL



### Applications

The products can be applied in industry, medical, EV charger, elevator, etc.



#### ΑΥΤΟΜΑΤΕΣ ΑΣΦΑΛΕΙΕΣ ΔΙΠΟΛΙΚΕΣ MINIATURE CIRCUIT BREAKER DC 2P 6kA 500V

CODE	DESCRIPTION	MODULES	PACKING
500-45102	16A	2	6\60
500-45103	20A	2	6\60
500-45104	25A	2	6\60
500-45105	32A	2	6\60



#### ΑΣΦΑΛΕΙΟΘΗΚΗ DC DIN RAIL FUSE CARRIERS

CODE	DESCRIPTION	MODULES	PACKING
500-22002	DC STI-32 10X38 500VDC 2P	2	6\60
500-22003	DC STI-32 10X38 500VDC 3PN	3	4\40
500-22004	DC STI-32 10X38 1000VDC 2P	2	6\60



#### ΑΣΦΑΛΕΙΕΣ DC FUSE DC

CODE	DESCRIPTION	PACKING
147-61220	DC 16A 1000V	10\200\1200
147-61221	DC 20A 1000V	10\200\1200
147-61222	DC 25A 1000V	10\200\1200
147-61223	DC 32A 1000V	10\200\1200



#### ΑΝΤΙΚΕΡΑΥΝΙΚΑ DC SURGE PROTECTIVE DEVICE DC

CODE	DESCRIPTION	MODULES	PACKING
500-22220	PV50 1000V T1+T2 12.5kA	2	1\43

#### ΔΙΑΚΟΠΤΕΣ-MCCB-MCB MCCB-MCB

CODE	DESCRIPTION	MODULES	PACKING
500-45500	MCB 16A 1000V 4P	2	1\20
500-45600	MCCB 125A 1000V 2P	2	1\6

# ΒΙΟΜΗΧΑΝΙΚΟΥ ΤΥΠΟΥ - INDUSTRIAL TYPE

## ΡΕΛΕ ΙΣΧΥΟΣ

AC CONTACTOR

### GC1

Accessories: PC transparent dust cover, F4 top auxiliary contact, FC6 side auxiliary contact, FR6 mechanical interlock

Certification: CE

Standards: IEC 60947-1 General provisions and IEC 60947-4-1



Product Naming Rules

G	C	3-	06	11	230V	Z
CORPORATE CODE	AC CONTACTOR	DESIGN SERIAL No.	RATED CURRENT	CONTACTOR TYPE	CONTROL VOLTAGE	DC CONTROL CIRCUIT
G	C	3	40A/50A/65A 80A/95A	11: 1NO1NC 40: Main contact 4NO 22: Main contact 2NO+2NC	AC:24V/36V/110V 220V/380V DC:24/110/220V	Z

### GC3

GC3 AC contactor: 6~38A, totally 6 current specifications

Certification: CE, CB

Standards: IEC 60947-1 General provisions and IEC 60947-4-1



Product Naming Rules

G	C	3-	06	11	230V	Z
CORPORATE CODE	AC CONTACTOR	DESIGN SERIAL No.	RATED CURRENT	CONTACTOR TYPE	CONTROL VOLTAGE	DC CONTROL CIRCUIT
G	C	3	06A/09A/12A 18A/25A/32A/38A	11: 1NO+1NC	AC:24V/36V/48V/110V 220V/380V/400V/415V DC:24V 148V /110V 1220V	Z

## ΡΕΛΕ ΙΣΧΥΟΣ ΜΕ ΠΗΝΙΟ 230V AC CONTACTOR WITH COIL 230VAC

CODE	TYPE	DESCRIPTION	PACKING
500-30010	SC 0911 GC3	4KW	1\50
500-30011	SC 1211 GC3	5,5KW	1\50
500-30012	SC 1811 GC3	7,5KW	1\50
500-30013	SC 2511 GC3	11KW	1\40
500-30014	SC 3211 GC3	15KW	1\40
500-30015	SC 4011 GC3	18,5KW	1\20
500-30016	SC 5011 GC1	22KW	1\20
500-30017	SC 6511 GC1	30KW	1\20
500-30018	SC 8011 GC1	37KW	1\16
500-30019	SC 9511 GC1	45KW	1\16
500-30020	GC1	55KW	1\16

## ΑΞΕΣΟΥΑΡ ΓΙΑ ΡΕΛΕ ΙΣΧΥΟΣ

AC CONTACTORS ACCESSORIES



ΒΟΗΘΗΤΙΚΕΣ ΕΠΑΦΕΣ  
AUXILIARY CONTACTS



ΧΡΟΝΙΚΟ ΓΙΑ ΡΕΛΕ ΙΣΧΥΟΣ  
ELECTRICAL DELAY



ΠΗΝΙΑ  
COILS

LAST Air delay head

Installation Position	Number of contacts	Delay type	Set range	Type
Top	1NO+1NC	Power-on delay	0.1-3s	LAST-20
	1NO+1NC		0.1-30s	LAST-22
	1NO+1NC		10-180s	LAST-24
	1NO+1NC	Blackout delay	0.1-3s	LAST-30
	1NO+1NC		0.1-30s	LAST-32
	1NO+1NC		10-180s	LAST-34

### ΒΟΗΘΗΤΙΚΕΣ ΕΠΑΦΕΣ AUXILIARY CONTACT

CODE	DESCRIPTION	PACKING
500-30200	2NO	1\300
500-30201	1NO+1NC	1\300
500-30202	2NC	1\300
500-30203	2NO+2NC	1\180
500-30220	SIDE MOUNT 1NO+1NC	1\200

### ΧΡΟΝΙΚΟ ΚΑΘΥΣΤΕΡΗΣΗΣ ΓΙΑ ΡΕΛΕ ΙΣΧΥΟΣ ELECTRICAL DELAY

CODE	DESCRIPTION	PACKING
500-30210	LAST2 0.1s~30s	1\100
500-30211	LASR2 0.1s~30s	1\100

### ΠΗΝΙΑ COILS

CODE	DESCRIPTION	PACKING
500-30230	09-18A 24V	1\100
500-30231	25-32A 24V	1\100
500-30232	40-95A 24V	1\100

# ΒΙΟΜΗΧΑΝΙΚΟΥ ΤΥΠΟΥ - INDUSTRIAL TYPE

## ΘΕΡΜΙΚΑ ΓΙΑ ΡΕΛΕ ΙΣΧΥΟΣ

OVERLOAD THERMAL RELAY CONTACTORS

### JR28

- Τριφασικό Θερμομαγνητικό ράγας
- Με συνεχώς ρυθμιζόμενη συσκευή για τη ρύθμιση του ρεύματος
- Με αντιστάθμιση θερμοκρασίας
- Με οδηγίες λειτουργίας
- Με κουμπί διακοπής
- Με κουμπί χειροκίνητης και αυτόματης επαναφοράς
- Με ηλεκτρικά αποσπώμενη επαφή, μία κανονικά ανοιχτή και μία κανονικά κλειστή.
- Three-phase bimetallic din rail
- With continuous adjustable device for setting current
- With temperature compensation
- With instruction manual
- Has a stop button
- With manual and automatic reset buttons
- With electrically separable one normally open and one commonly closed contact



Οι σειρές GVS2 και GVS3 είναι ηλεκτρομηχανικές συσκευές προστασίας για το κύριο κύκλωμα. Χρησιμοποιούνται κυρίως για την ενεργοποίηση/απενεργοποίηση κινητήρων χειροκίνητα και για την προστασία τους χωρίς ασφάλειες από βραχυκύκλωμα και απώλεια φάσης. Η προστασία χωρίς ασφάλειες με τον χειροκίνητο εκκινητή κινητήρα εξοικονομεί κόστος, χώρο και εξασφαλίζει γρήγορη αντίδραση σε περίπτωση βραχυκυκλώματος, απενεργοποιώντας τον κινητήρα μέσα σε χιλιοστά του δευτερολέπτου. Οι συνδυασμοί χειροκίνητων εκκινητών κινητήρων διαμορφώνονται μαζί με επαφές και ρελέ υπερφόρτωσης.

JR28 overload thermal relays contactors are designed for protection of motors mainly. These relays can be either combined directly with contactors of GCI/3 series or used as a stand-alone device. Relays are available in four frame sizes for rated non-reduced currents from 0.1- 100 A. JR28 relays are equipped with 1 NO and 1 NC auxiliary contacts.

#### General Parameter

	JR28-11.5	JR28-25	JR28-36	JR28-93
Tested according to	IEC/EN 60947-4-1			
Rated op. voltage Ue	380V AC			
Rated insulating voltage Ui	380V AC			
Rated impulse withstand voltage Uimp	6kV			
Rated frequency	50/60Hz			
Current setting range (per frame size)	0.1-13	0.1-25	23-40	17-95
Tripping threshold	1.14±0.06xIn			
Phase failure detection	30% in a phase			
Tripping Class	10A			
Reset	Manual or Auto			

#### ΘΕΡΜΙΚΑ ΓΙΑ ΡΕΛΕ ΙΣΧΥΟΣ OVERLOAD THERMAL RELAY

CODE	AMPERAGE	CONNECTION	PACKING
500-30100	0.63 - 1A	GC3	1\100
500-30101	1 - 1.6A	GC3	1\100
500-30102	1.6 - 2.5A	GC3	1\100
500-30103	2.5 - 4A	GC3	1\100
500-30104	4 - 6A	GC3	1\100
500-30105	5.5 - 8A	GC3	1\100
500-30106	7 - 10A	GC3	1\100
500-30107	9 - 13A	GC3	1\100
500-30108	12 - 18A	GC3	1\100
500-30109	17 - 25A	GC3	1\100
500-30110	23 - 32A	GC1	1\50
500-30111	30 - 38A	GC1	1\50
500-30112	37 - 50A	GC1	1\50
500-30113	48 - 65A	GC1	1\50
500-30114	63 - 80A	GC1	1\50
500-30115	80 - 93A	GC1	1\50

\* Οι τιμές θα είναι διαθέσιμες κατόπιν αιτήματος παραγγελίας / Pricing will be provided upon order request

## ΘΕΡΜΟΜΑΓΝΗΤΙΚΟ ΡΑΓΑΣ

DIN RAIL MOTOR PROTECTION CIRCUIT BREAKER

### GVS2,GVS3

- Τριφασικό ρελέ υπερφόρτωσης τύπου διμεταλλικού φύλλου
- Με συσκευή συνεχούς ρύθμισης για την ρύθμιση του ρεύματος
- Με αντιστάθμιση θερμοκρασίας
- Με οδηγίες λειτουργίας
- Διαθέτει οργανισμό δοκιμών
- Με κουμπί διακοπής
- Με κουμπί χειροκίνητης και αυτόματης επαναφοράς
- Με ηλεκτρικά αποσπώμενη επαφή, μία κανονικά ανοιχτή και μία κανονικά κλειστή.
- Three-phase bimetallic sheet type
- With continuous adjustable device for setting current
- With temperature compensation
- With action instructions
- Has a testing organization
- Has a stop button
- With manual and automatic reset buttons
- With electrically separable one normally open and one commonly closed contact



Τα ρελέ υπερφόρτωσης JR28 είναι σχεδιασμένα κυρίως για την προστασία κινητήρων. Αυτά τα ρελέ μπορούν να συνδυαστούν άμεσα με επαφείς της σειράς GCI/3 ή να χρησιμοποιηθούν ως αυτόνομες συσκευές. Τα ρελέ είναι διαθέσιμα σε τέσσερις μεγέθη πλαισίων για ονομαστικά ρεύματα χωρίς μείωση από 0,1 έως 100 A. Τα ρελέ JR28 είναι εξοπλισμένα με 1 βοηθητική επαφή NC (κανονικά κλειστή) και 1 βοηθητική επαφή NO (κανονικά ανοιχτή).

GVS2,GVS3 Series manual motor starters are electromechanical protection devices for the main circuit. They are used mainly to switch motors manually ON/OFF and protect them fuseless against short circuit and loss-phase. Fuseless protection with a manual motor starter saves costs, space and ensures a quick reaction under short-circuit condition, by switching off the motor within milliseconds. Manual motor starter combinations are setup together with contactors and overload relays.

#### Type Key

GVS	2	ME	32	0.16
DESIGN CODE	FRAME SIZE	OPERATION TYPE	CURRENT	RATED CURRENT
GVS	2 or 3	ME: Push button	32: up to 32A 80: up to 80A	0.16-BOA

#### ΘΕΡΜΟΜΑΓΝΗΤΙΚΟ ΡΑΓΑΣ MOTOR PROTECTORS

CODE	Amperage	PACKING
500-30250	1 - 1.6A	1\50
500-30251	1.6 - 2.5A	1\50
500-30252	2.5 - 4A	1\50
500-30253	4 - 6.3A	1\50
500-30254	6 - 10A	1\50
500-30255	13 - 18A	1\50
500-30256	17 - 23A	1\50

# ΒΙΟΜΗΧΑΝΙΚΟΥ ΤΥΠΟΥ - INDUSTRIAL TYPE

## ΕΠΙΤΗΡΗΤΕΣ ΤΑΣΗΣ ΡΑΓΑΣ

### VOLTAGE PROTECTOR

#### Applications

Ο επιτηρητής τάσης είναι μια ηλεκτρονική συσκευή που προστατεύει όλη την εγκατάσταση από υπόταση και υπέρταση. Τοποθετείται μετά από τον γενικό διακόπτη και την ασφάλεια τήξεως μέσα στον ηλεκτρολογικό πίνακα σύμφωνα με τις διατάξεις του ΕΛΟΤ HD 384. Ο επιτηρητής έχει δυο επαφές, μια "NO" (Normal Open) και μια "NC" (Normal Close) με τις οποίες μπορούμε να έχουμε τον έλεγχο του κυκλώματος.



#### ΕΠΙΤΗΡΗΤΕΣ ΤΑΣΗΣ VOLTAGE PROTECTOR

CODE	DESCRIPTION	MODULES	PACKING
500-22500	SINGLE PHASE 40A 2P 175-275V	2	1\6\120
500-22501	SINGLE PHASE 63A 2P 175-275V	4	1\6\120
500-22502	TRIPLE PHASE 63A 4P 300-460V	2	1\3\60

## ΜΕΤΑΓΩΓΙΚΟΣ ΔΙΑΚΟΠΤΗΣ

### DIN RAIL CHANGEOVER SWITCHES

#### Applications

Ο μεταγωγικός διακόπτης αποτελεί την ιδανική λύση για τον έλεγχο και την απομόνωση δυο κυκλωμάτων ισχύος. Αποτελείται από 3 θέσεις (I-O-II). Η κύρια λειτουργία του είναι για μεταγωγή εκτάκτου ανάγκης από την σταθερή παροχή λειτουργίας στην παροχή γεννήτριας σε περίπτωση διακοπής ρεύματος.



#### ΡΕΛΕ ΙΣΧΥΟΣ ΡΑΓΑΣ WIFI MODULAR CONTACTOR WIFI

CODE	DESCRIPTION	PACKING
500-42160	2x40A	1\6\120
500-42161	4x40A	1\3\60

## ΔΙΑΚΟΠΤΗΣ ΡΕΥΜΑΤΟΣ

### MAIN ISOLATOR SWITCH

#### Applications

Ο διακόπτης "Isolator" χρησιμοποιείτε προκειμένου να διασφαλιστεί η ασφάλεια και να μειωθεί ο κίνδυνος ηλεκτρικών προβλημάτων. Ο συγκεκριμένος διακόπτης τοποθετείται πριν από την ηλεκτρική μονάδα ώστε να αποτραπεί η ροή δυνητικού ρεύματος στο συγκεκριμένο κύκλωμα. Η λειτουργία του είναι να διακόπτει το κύκλωμα υπό εμφανές σημείο και να διασφαλίζει την ασφάλεια του συντηρητή.



#### ΔΙΑΚΟΠΤΕΣ ΡΕΥΜΑΤΟΣ ISOLATOR

CODE	DESCRIPTION	PACKING
500-12113	4X35A 380V	1\20

## ΡΕΛΕ ΚΑΣΤΑΝΙΑΣ

### RELAY LATHING

#### Applications

Το ρελέ ρευματώθησης (καστανίας), κάθε φορά που εφαρμόζεται μια τάση ή ένας παλμός στα άκρα του, αλλάζει η κατάσταση των επαφών του και παραμένει η ίδια μέχρι να δεχτεί εκ νέου μια νέα τάση ή ένα παλμό. Η κύρια χρήση του είναι για τον έλεγχο ενός κυκλώματος όπως παραδείγματος χάρι του φωτισμού, μέσω παράλληλων μπουτόν από περισσότερες Θέσεις.



#### ΡΕΛΕ ΚΑΣΤΑΝΙΑΣ RELAY LATHING

CODE	TYPE	DESCRIPTION	PACKING
500-37160	2NO	16A 220V AC/OC	1\120
500-37300	2NO	25A 230V AC	12\120

NEW

## ΜΟΝΤΑΡΙΣΜΕΝΟΙ ΠΙΝΑΚΕΣ

PRE-WIRED DIN RAIL ENCLOSURES



GACIA

### Applications

Ο μονταρισμένος πίνακας αποτελείται από μια σειρά ραγούλικού με τα βασικά στοιχεία ενός ηλεκτρολογικού πίνακα σύμφωνα με τις διατάξεις του ΕΛΟΤ HD 384. Για την εγκατάστασή του, θα πρέπει να απευθυνθείτε σε έμπειρο ηλεκτρολόγο όπου Θα βεβαιώσει πως η εγκατάσταση Θα πραγματοποιηθεί σύμφωνα με τις απαιτούμενες διατάξεις. Η λανθασμένη εγκατάσταση και χρήση μπορούν να προκαλέσουν κίνδυνο ηλεκτροπληξίας ή πυρκαγιάς.

## ΜΟΝΤΑΡΙΣΜΕΝΟΙ ΠΙΝΑΚΕΣ

PRE-WIRED DIN RAIL ENCLOSURES

GACIA



500-42900  
500-42301 x2  
500-42302 x3  
500-42305  
500-42323

500-42324  
500-37000  
500-43601  
500-42305  
500-39001 x2



### ΠΕΡΙΛΑΜΒΑΝΕΙ / INCLUDES

500-37002  
500-43005 x3  
500-43606  
500-39002 x4  
500-42301 x3  
500-42302 x6  
500-43002  
500-42323  
500-42324



### ΠΕΡΙΛΑΜΒΑΝΕΙ / INCLUDES

500-37000  
500-43005  
500-43601  
500-42301 x2  
500-42302 x3  
500-43002  
500-42323  
500-42324  
500-39001 x1



### ΠΕΡΙΛΑΜΒΑΝΕΙ / INCLUDES

500-43604  
500-37000  
500-39001 x3  
500-42313  
500-42314  
500-42301 x2  
500-42302 x2  
500-42305

### ΠΙΝΑΚΕΣ FUSE BOXES

CODE	DESCRIPTION	PACKING
500-42900	GACIA SET 40A ΜΟΝΟΦΑΣΙΚΟΥ ΠΙΝΑΚΑ ΠΛΗΡΗΣ PROMO	1\1
500-42910	ΠΙΝΑΚΑΣ ΧΩΝΕΥΤΟΣ ΜΟΝΟΦΑΣΙΚΟΣ ΠΛΗΡΗΣ 40A GACIA	1\1
500-42911	ΠΙΝΑΚΑΣ ΧΩΝΕΥΤΟΣ ΤΡΙΦΑΣΙΚΟΣ ΠΛΗΡΗΣ 3X40A GACIA	1\1
500-42912	ΠΙΝΑΚΑΣ ΧΩΝΕΥΤΟΣ ΜΟΝΟΦΑΣΙΚΟΣ 2 ΣΕΙΡΩΝ ΠΛΗΡΗΣ 40A GACIA	1\1



Στη γκάμα των έξυπνων συσκευών για το σπίτι από τη EUROLAMP Smart, περιλαμβάνονται λαμπτήρες Wi-Fi, σύστημα ασφαλείας, αντάπτορες ρεύματος, πολύπριζα, «έξυπνα» τηλεχειριστήρια υπέρυθρων (IR remote controller), και εμπλουτίζεται συνεχώς με νέα είδη.

Η εφαρμογή EUROLAMP Smart app είναι εύκολη στη χρήση και είναι πλήρως συμβατή με όλες τις συσκευές EUROLAMP Smart WiFi, αλλά και όλες τις συσκευές που φέρουν την ένδειξη «Powered by TUYA». Άρα με μια εφαρμογή μπορεί ο χρήστης να ελέγξει όλες τις «έξυπνες» συσκευές χωρίς περιορισμούς.

Για την χρήση των Smart προϊόντων, είναι απαραίτητη η εγκατάσταση της εφαρμογής EUROLAMP SMART WI-FI στη συσκευή σας.

The range of smart home appliances from EUROLAMP Smart includes Wi-Fi Lamps, power adaptors, sockets, “smart” infrared remote controls, and new items are added continuously.

The EUROLAMP Smart app is easy to use and is fully compatible with all EUROLAMP Smart WiFi devices, as well as all devices with “Powered by TUYA” indication. The user can manage all the “smart” devices with one application, without restrictions.

For using the Smart Items, the EUROLAMP SMART WI-FI application must be installed to your device

Download & Install



Scan



Απαιτείται Android 4.4 και πάνω, & iOS 9.0 και πάνω.  
Requires Android 4.4 or higher, & iOS 9.0 or higher.



Έξυπνο Σπίτι

Smart Home



Πύλη ZigBee 3.0 με θύρα ethernet για σύνδεση μέχρι 100 συσκευών  
ZigBee 3.0 Gateway Lan connection support up to 100 devices

- Περιλαμβάνει τροφοδοτικό, καλώδιο USB (τροφοδοσίας) και καλώδιο δικτύου.
- Includes power supply with USB supply cable and LAN cable.



Η εφαρμογή EUROLAMP SMART Wi-Fi θα πρέπει να είναι εγκατεστημένη στη συσκευή σας  
EUROLAMP SMART Wi-Fi APP must be installed to your device

## Smart WiFi Smarthubs Wi-Fi ZigBee 3.0 Gateway

Volt 5V DC • Wireless Standard IEEE 802.15.4  
Operating Temperature -10°C /+55°C  
Υλικό / Material Πλαστικό / Plastic



Απαιτήσεις συστήματος / System Requirements  
Android 4.4 or higher & iOS 9.0 or higher



Code	Barcode	Maximum Sub-Devices	Lan Connection	Amperage mA	Dimension (mm)	Packing	MOQ
152-60679	5207227243288	100	YES	1000	60x100	1\ 50	1

## Smart WiFi



Έξυπνος Αντάπτορας Σούκο με WiFi και Μετρητή Ενέργειας  
Smart Adaptor Schuko with WiFi and Power Meter

Volt 220V-240V • Πρωτόκολλο / Protocol IEEE 802.11b/g/n  
Operating Temperature -10°C /+45°C  
Υλικό / Material Πλαστικό / Plastic



Η εφαρμογή EUROLAMP SMART Wi-Fi θα πρέπει να είναι εγκατεστημένη στη συσκευή σας.  
EUROLAMP SMART Wi-Fi APP must be installed to your device

Απαιτήσεις συστήματος / System Requirements  
Android 4.4 or higher & iOS 9.0 or higher

### Διαθέτει / Features:

- Λυχνία Λειτουργίας / Function Indicator
- Προστασία Επαφών / Shutter Protection
- Μετρητής Ενέργειας / With Power Meter
- Γείωση / Grounding



Συνδεσιμότητα Δικτύου  
Network Connectivity  
2,4GHz WIFI



Code	Barcode	Watt	Amperage mA	Dimension (mm)	Weight (kg)	Packing	MOQ
147-77912	5207227230554	3680	16000	82x52x52	0.085	1/20/80	2

## Smart WiFi



Έξυπνος Αντάπτορας Δύο Σούκο Κάθετος με WiFi & Μετρητή Ενέργειας  
Smart Adaptor Dual Schuko Vertical with WiFi & Power Meter

Volt 110-240V • Πρωτόκολλο / Protocol IEEE 802.11b/g/n  
Operating Temperature -10°C /+45°C  
Υλικό / Material Πλαστικό / Plastic



Η εφαρμογή EUROLAMP SMART Wi-Fi θα πρέπει να είναι εγκατεστημένη στη συσκευή σας.  
EUROLAMP SMART Wi-Fi APP must be installed to your device

Απαιτήσεις συστήματος / System Requirements  
Android 4.4 or higher & iOS 9.0 or higher

### Διαθέτει / Features:

- Μετρητής Ενέργειας / With Power Meter
- Λυχνία Λειτουργίας / Function Indicator
- Προστασία Επαφών / Shutter Protection
- Γείωση / Grounding



Συνδεσιμότητα Δικτύου  
Network Connectivity  
2,4GHz WIFI



Code	Barcode	Watt	Amperage mA	Dimension (mm)	Weight (kg)	Packing	MOQ
147-77917	5207227230585	3680	16000	82x50x97	0.130	1/10/100	2



Η εφαρμογή EUROLAMP SMART Wi-Fi θα πρέπει να είναι εγκατεστημένη στη συσκευή σας  
EUROLAMP SMART Wi-Fi APP must be installed to your device

Απαιτήσεις συστήματος / System Requirements  
Android 4.4 or higher & iOS 9.0 or higher

**Το Kit περιλαμβάνει / the Kit includes:**

- Έξυπνη κάμερα / Smart Camera
- Φορτιστή / Charger
- USB Καλώδιο / USB Cable

## Smart WiFi Κάμερα Ασφαλείας WiFi με Κίνηση 360° WiFi Security Camera 360°

Volt 5V DC • Stand by consumption >0,5W • Πρωτόκολλο / Protocol IEEE 802.11b/g/n

Operating Temperature -20°C / +50°C

Υλικό / Material Πλαστικό ABS / Plastic ABS



Συνδεσιμότητα Δικτύου  
Network Connectivity

**2,4GHz WiFi**



**2**  
YEARS  
WARRANTY

Code	Barcode	Watt	Amperage mA	Dimension (mm)	Weight (kg)	Packing	MOQ
147-77945	5207227154010	7	15000	80x65x100	0,318	1/50	1

- Επιτραπέζια και Επιτοίχια Τοποθέτηση / Surface & Wall Mounted
- Νυχτερινή Λήψη / Night Vision: <10m
- MicroSD max 128GB
- Διάμετρος Φακού / Lens Diameter 3.6mm - 110°
- Δυνατότητα Αποθήκευσης σε Cloud / Cloud Storage Capacity
- Αμφίδρομη Επικοινωνία / 2-Way Communication



Ανιχνευτής κίνησης  
Motion detection



360° Οριζόντια / Pan  
90° Κάθετα / Tilt



Ενσωματωμένο Μικρόφωνο  
Built-in Microphone



Ενσωματωμένο Ηχείο  
Speaker Built-in



Ανάλυση Βίντεο  
Video Resolution



Καταγραφή Συμβάντος  
Event Recording



Ειδοποίηση  
Συναγερμού Κίνησης  
Motion Alarm Notification



Εντοπισμός, καταγραφή  
και παρακολούθηση  
κίνησης

360°

90°



## Smart WiFi Ασύρματος Ανιχνευτής Κίνησης "Home Value" Wireless Motion Sensor PIR "Home Value"

Volt 2x1,5V AA batteries • Stand by Consumption 0,02mA • Wireless Standard 433,92MHz  
Wireless Accessories Range >150m • Alarm Consumption 25mA  
Operating Temperature -20°C / +50°C • Υλικό / Material Πλαστικό ABS / Plastic ABS



2x1,5V AA



IP20



Απόσταση Ανίχνευσης/ Detection Distance 5m  
Battery Discharge Time ~12 μήνες / ~12 months



Συνδεσιμότητα Δικτύου  
Network Connectivity  
**RF433 WiFi**



Code	Barcode	Amperage mA	Dimension (mm)	Weight (kg)	Packing	MOQ
147-77941	5207227147050	0,02	10x5,5x3,5	0,081	1/10/100	1



## Smart WiFi Ασύρματος Αισθητήρας Πόρτας/Παραθύρου "Home Value" Wireless Door/Window Sensor "Home Value"

Volt 12V 23A battery • Stand by Consumption 0,03mA • Wireless Standard 433,92MHz  
Wireless Accessories Range >100m • Alarm Consumption 40mA  
Operating Temperature -20°C / +50°C • Υλικό / Material Πλαστικό ABS / Plastic ABS



12V 23A



IP20



Battery Discharge Time ~12 μήνες / ~12 months

Περιλαμβάνει / Includes:

- Μαγνητική Επαφή / Door Sensor
- Μπαταρία / Battery
- Ταινίες Διπλής Όψης 3M Mounting 3M Tape



Συνδεσιμότητα Δικτύου  
Network Connectivity  
**RF433 WiFi**



Code	Barcode	Amperage mA	Dimension (mm)	Weight (kg)	Packing	MOQ
147-77942	5207227147067	0,03	6,5x2,5x1,5	0,039	1/25/250	1



## Smart WiFi Ασύρματα Εξωτερική Σειρήνα Συναγερμού "Home Value" Wireless External Alarm Siren "Home Value"

Volt 7.4V 400mAh Lithium battery • Stand by Consumption 15mA  
Wireless Accessories Range >100m • Alarm Consumption 300mA  
Operating Temperature -10°C / +50°C • Υλικό / Material Πλαστικό ABS / Plastic ABS



Sound Alarm

120 dB



7.4V 400mAh



IP44



Battery Discharge Time 8 ώρες \ hours

Περιλαμβάνει / Includes:

- Σειρήνα με φλας / Siren
- Μπαταρία / Battery
- Βίδες Στήριξης / Mounting Screws



Συνδεσιμότητα Δικτύου  
Network Connectivity  
**RF433 WiFi**



Code	Barcode	Amperage mA	Dimension (mm)	Weight (kg)	Packing	MOQ
147-77944	5207227147081	0,03	9,32x3,85x15,21	0,395	1/50	1



Η εφαρμογή EUROLAMP SMART Wi-Fi θα πρέπει να είναι εγκατεστημένη στη συσκευή σας  
EUROLAMP SMART Wi-Fi APP must be installed to your device

Απαιτήσεις συστήματος / System Requirements  
Android 4.4 or higher & iOS 9.0 or higher

**Battery Discharge Time**  
~8-10 μήνες (σε standby λειτουργία)  
~8-10 months (in standby mode)



Συνδεσιμότητα Δικτύου  
Network Connectivity  
**Bluetooth V5.0**



**Smart WiFi** Έξυπνη Κλειδοθήκη με Bluetooth, Αποτύπωμα, Κωδικό  
**Smart Key Box Locker with Bluetooth, Fingerprint, Code**

Volt 6V 4xAAA batteries • Operating Temperature -20°C /+50°C  
Wireless Accessories Range Έως 30m σε εξωτερικούς, 10m σε εσωτερικούς χώρους/ Up to 30m outdoors, 10m indoors  
Υλικό / Material Σώμα από κράμα ψευδαργύρου, γάντζος από ανοξείδωτο χάλυβα / Zinc alloy body, stainless steel hook



Code	Barcode	Amperage mA	Dimension (mm)	Weight (kg)	Packing	MOQ
147-77950	5207227147050	0,02	50x70x120	0,081	1/20	1

**Διαθέτει / Features:**

- Πληκτρολόγια για κωδικό / Keypads for code
- Αναγνώριση δαχτυλικού αποτυπώματος / Fingerprint recognition
- 2 κάρτες RFID / 2 RFID cards
- Δυνατότητα ξεκλειδώματος μέσω της εφαρμογής (σύνδεση Bluetooth). / Ability to unlock by using the application (Bluetooth connection)

Τροφοδοσία από 4xAAA μπαταρίες αλλά και υποδοχή USB για τροφοδοσία έκτακτης ανάγκης.  
Powered by 4xAAA batteries but also a USB port for emergency power.





# ΕΥΡΕΤΗΡΙΟ ΚΩΔΙΚΩΝ CODE INDEX

ΗΛΕΚΤΡΟΛΟΓΙΚΟ ΥΛΙΚΟ  
ELECTRICAL EQUIPMENT

ΚΤΙΡΙΑΚΟΣ ΕΞΟΠΛΙΣΜΟΣ  
BUILDING EQUIPMENT

ΕΠΑΓΓΕΛΜΑΤΙΚΟΣ ΕΞΟΠΛΙΣΜΟΣ ΜΠΑΝΙΟΥ  
PROFESSIONAL BATHROOM EQUIPMENT

ΕΡΓΑΛΕΙΑ  
TOOLS

ΑΝΑΛΩΣΙΜΟ ΗΛΕΚΤΡΟΛΟΓΙΚΟ ΥΛΙΚΟ  
ELECTRICAL CONSUMABLES

ΥΛΙΚΑ ΦΩΤΙΣΤΙΚΩΝ  
LIGHTING HARDWARE

ΑΝΑΛΩΣΙΜΟ ΥΛΙΚΟ  
CONSUMABLES

ΚΑΛΩΔΙΑ  
CABLES

ΠΙΝΑΚΕΣ  
FUSES BOXES

ΔΙΑΚΟΠΤΕΣ  
SWITCHES

ΑΣΦΑΛΕΙΕΣ  
FUSES

ΓΑΣΙΑ

ΕΞΥΠΝΟ ΣΠΙΤΙ  
SMART HOME

ΕΥΡΕΤΗΡΙΟ ΚΩΔΙΚΩΝ  
CODE INDEX

Code	pg	Code	pg	Code	pg	Code	pg	Code	pg	Code	pg
147-02000	46	147-09002	29	147-10060	98	147-10179	100	147-11204	70	147-12211	124
147-02001	46	147-09010	29	147-10061	98	147-10306	26	147-11220	71	147-12212	124
147-02002	50	147-09012	29	147-10062	99	147-10310	27	147-11221	71	147-12230	124
147-02003	46	147-09014	29	147-10063	99	147-10319	27	147-11222	71	147-12231	124
147-02004	46	147-09050	27	147-10064	99	147-11000	70	147-11223	71	147-12232	124
147-02005	46	147-09103	42	147-10065	99	147-11001	70	147-11224	71	147-12233	124
147-02006	50	147-09105	42	147-10066	99	147-11002	70	147-11225	71	147-12236	124
147-02007	46	147-09106	43	147-10068	100	147-11003	70	147-11226	71	147-12240	125
147-02008	50	147-09107	43	147-10069	99	147-11004	70	147-11227	71	147-12241	125
147-02009	46	147-09108	43	147-10070	99	147-11005	70	147-11230	71	147-12242	125
147-02010	72	147-09109	43	147-10071	100	147-11020	77	147-11231	71	147-12244	125
147-02011	72	147-10000	28	147-10074	99	147-11030	72	147-11232	71	147-12245	125
147-02012	72	147-10001	28	147-10091	98	147-11031	72	147-11233	71	147-12246	125
147-02016	48	147-10002	26	147-10100	101	147-11032	72	147-11234	71	147-13011	31
147-02017	49	147-10004	26	147-10101	101	147-11040	68	147-11235	71	147-13012	31
147-02030	52	147-10006	26	147-10102	101	147-11041	68	147-11240	71	147-13013	31
147-02035	52	147-10007	27	147-10103	101	147-11042	68	147-11241	71	147-13014	31
147-02057	159	147-10009	83	147-10104	101	147-11043	68	147-11242	71	147-13015	31
147-02062	159	147-10010	27	147-10105	101	147-11044	68	147-11243	71	147-13016	31
147-02063	159	147-10011	26	147-10106	101	147-11045	68	147-11244	71	147-13017	31
147-02064	159	147-10012	26	147-10107	101	147-11046	68	147-11245	71	147-13018	31
147-02065	159	147-10013	28	147-10110	102	147-11047	68	147-11250	120	147-13019	31
147-02066	159	147-10014	28	147-10120	102	147-11048	69	147-11251	120	147-13025	31
147-02067	159	147-10017	42	147-10121	102	147-11049	69	147-11252	120	147-13026	31
147-02100	100	147-10019	27	147-10122	102	147-11050	69	147-11253	120	147-13031	31
147-02310	46	147-10020	26	147-10123	102	147-11060	68	147-11254	120	147-13032	31
147-02311	47	147-10021	42	147-10124	102	147-11061	68	147-11300	72	147-13033	31
147-02312	47	147-10022	42	147-10125	102	147-11062	68	147-11302	72	147-13041	44
147-02322	48	147-10023	24	147-10140	102	147-11063	69	147-11303	72	147-13042	44
147-02323	48	147-10024	24	147-10141	102	147-11064	69	147-11304	72	147-13080	31
147-02324	48	147-10025	25	147-10142	102	147-11065	69	147-11310	70	147-13080	44
147-02325	48	147-10029	29	147-10143	102	147-11066	69	147-11311	70	147-13100	99
147-02326	49	147-10032	25	147-10144	102	147-11067	69	147-11312	70	147-13110	99
147-02327	49	147-10033	25	147-10150	100	147-11068	69	147-11400	78	147-13126	101
147-02343	50	147-10038	24	147-10151	100	147-11069	69	147-11401	78	147-13127	101
147-02344	50	147-10039	24	147-10152	100	147-11070	69	147-11404	78	147-13128	101
147-02345	50	147-10042	24	147-10153	100	147-11071	69	147-11405	78	147-13129	101
147-02346	50	147-10044	126	147-10154	100	147-11072	69	147-11406	78	147-13261	126
147-02347	51	147-10045	126	147-10155	100	147-11073	69	147-11407	78	147-13262	126
147-02348	51	147-10050	98	147-10170	100	147-11074	69	147-11410	78	147-13305	82
147-05800	126	147-10051	98	147-10171	100	147-11080	70	147-11411	78	147-13310	82
147-05801	126	147-10052	98	147-10172	100	147-11081	70	147-11412	78	147-13313	82
147-08010	109	147-10053	98	147-10173	100	147-11082	70	147-11413	78	147-16021	99
147-08500	73	147-10054	98	147-10174	100	147-11083	70	147-11414	78	147-16050	98
147-08501	73	147-10055	98	147-10175	100	147-11200	70	147-11415	78	147-16051	98
147-08502	73	147-10056	98	147-10176	100	147-11201	70	147-11416	78	147-16052	98
147-08600	72	147-10057	98	147-10177	100	147-11202	70	147-11417	78	147-16053	98
147-08601	72	147-10059	98	147-10178	100	147-11203	70	147-12210	124	147-16054	98

Code	pg	Code	pg	Code	pg	Code	pg	Code	pg	Code	pg
147-16055	98	147-18022	65	147-23071	82	147-31140	111	147-31443	113	147-32021	53
147-16056	98	147-18023	65	147-23075	82	147-31141	111	147-31444	113	147-33210	60
147-16057	98	147-18500	66	147-23077	82	147-31142	111	147-31445	113	147-33211	60
147-16058	98	147-18501	66	147-23081	80	147-31143	111	147-31446	113	147-33220	60
147-16059	98	147-18502	66	147-23100	83	147-31144	111	147-31447	113	147-33230	61
147-16202	37	147-22003	84	147-23110	83	147-31145	111	147-31448	113	147-33231	61
147-16203	36	147-22004	84	147-23120	83	147-31146	111	147-31450	114	147-33232	61
147-16204	36	147-23000	80	147-23121	83	147-31200	105	147-31451	114	147-33240	60
147-16205	36	147-23002	80	147-23130	83	147-31201	105	147-31500	116	147-33241	60
147-16210	124	147-23003	80	147-23131	83	147-31202	105	147-31501	116	147-33242	60
147-16213	124	147-23004	80	147-23150	82	147-31203	105	147-31502	116	147-33243	60
147-16215	124	147-23008	80	147-23151	82	147-31204	105	147-31503	116	147-33250	61
147-16216	124	147-23009	80	147-23152	82	147-31210	104	147-31510	116	147-34000	64
147-16220	124	147-23010	80	147-23153	82	147-31211	104	147-31511	116	147-34001	64
147-16221	124	147-23011	80	147-23155	82	147-31212	104	147-31512	116	147-34002	64
147-16241	125	147-23012	80	147-23160	83	147-31220	104	147-31513	116	147-34003	64
147-16242	125	147-23013	80	147-23161	83	147-31221	104	147-31514	116	147-34004	64
147-16243	125	147-23014	80	147-23162	83	147-31222	104	147-31520	116	147-34005	64
147-16244	125	147-23015	80	147-23170	83	147-31400	112	147-31521	117	147-34006	64
147-16245	125	147-23016	80	147-23171	83	147-31401	112	147-31522	117	147-34007	64
147-16246	125	147-23018	80	147-31023	106	147-31402	112	147-31523	117	147-34008	64
147-16247	125	147-23020	80	147-31024	106	147-31403	112	147-31524	117	147-34010	64
147-16252	125	147-23022	80	147-31030	106	147-31404	112	147-31525	117	147-34011	64
147-16253	125	147-23029	80	147-31031	106	147-31405	112	147-31526	117	147-34020	64
147-16254	125	147-23030	80	147-31032	107	147-31406	112	147-31527	117	147-34021	64
147-16255	125	147-23031	80	147-31033	107	147-31407	112	147-31528	118	147-34032	64
147-16500	30	147-23032	80	147-31034	107	147-31408	112	147-31529	118	147-34033	64
147-16501	30	147-23036	80	147-31035	107	147-31409	112	147-31530	118	147-34050	64
147-16502	30	147-23037	80	147-31036	107	147-31410	112	147-31531	118	147-35000	54
147-16503	30	147-23040	81	147-31037	107	147-31411	112	147-31532	118	147-35001	54
147-16504	30	147-23041	81	147-31040	108	147-31412	112	147-31550	119	147-35002	42
147-16505	30	147-23042	81	147-31041	108	147-31413	112	147-31551	119	147-35010	157
147-16510	30	147-23043	81	147-31042	108	147-31414	112	147-31552	119	147-35011	157
147-16511	30	147-23044	81	147-31043	108	147-31415	112	147-31560	119	147-35012	54
147-16512	30	147-23045	81	147-31120	110	147-31416	112	147-31561	119	147-44002	55
147-16513	30	147-23050	81	147-31121	110	147-31417	112	147-31562	119	147-44012	56
147-16514	30	147-23051	81	147-31122	110	147-31418	112	147-31900	115	147-44013	56
147-16515	30	147-23052	81	147-31123	110	147-31419	112	147-31901	115	147-44014	56
147-16520	30	147-23053	81	147-31124	110	147-31420	113	147-31902	115	147-44030	57
147-16521	30	147-23054	81	147-31125	110	147-31421	113	147-31903	115	147-44035	57
147-16522	30	147-23055	81	147-31126	110	147-31422	113	147-31910	115	147-44040	56
147-16523	30	147-23056	81	147-31130	110	147-31423	113	147-31911	115	147-44041	57
147-16524	30	147-23057	81	147-31131	110	147-31430	114	147-31912	115	147-44045	57
147-16525	30	147-23058	81	147-31132	110	147-31431	114	147-31913	115	147-44050	56
147-18000	65	147-23059	81	147-31133	110	147-31432	114	147-32000	53	147-44500	55
147-18001	65	147-23061	82	147-31134	110	147-31440	113	147-32001	53	147-44501	55
147-18020	65	147-23065	82	147-31135	110	147-31441	113	147-32002	53	147-44502	55
147-18021	65	147-23067	82	147-31136	110	147-31442	113	147-32020	53	147-45001	62

ΕΥΡΕΤΗΡΙΟ ΚΩΔΙΚΩΝ  
CODE INDEX

Code	pg	Code	pg	Code	pg	Code	pg	Code	pg	Code	pg
147-45010	62	147-54008	74	147-60004	73	147-61500	129	147-62233	35	147-77945	175
147-45011	62	147-54009	74	147-61002	128	147-61501	129	147-62240	34	147-77950	177
147-45100	62	147-54010	74	147-61003	128	147-61502	130	147-62241	34	147-99807	28
147-45101	62	147-54012	74	147-61004	128	147-61503	130	147-62242	34	147-99846	23
147-47000	37	147-54013	74	147-61005	128	147-61504	130	147-62243	34	151-21000	121
147-47025	39	147-54014	74	147-61006	128	147-61510	129	147-62250	35	151-21001	121
147-47031	39	147-54015	74	147-61007	128	147-61511	129	147-62251	35	151-21002	121
147-47032	39	147-54016	74	147-61008	128	147-61512	130	147-62252	35	151-21003	121
147-47040	37	147-54017	74	147-61009	128	147-61513	130	147-62253	35	151-21004	121
147-47041	38	147-54018	74	147-61010	128	147-61514	130	147-62260*	35	151-21008	121
147-47042	38	147-54021	74	147-61011	128	147-61515	130	147-62261	35	151-21020	122
147-47043	38	147-54022	74	147-61023	128	147-61520	129	147-62262	35	151-21021	122
147-47044	39	147-54025	74	147-61024	128	147-61521	129	147-62263	35	151-21027	122
147-47045	39	147-54027	74	147-61025	128	147-61522	130	147-62264	35	151-21028	122
147-47049	38	147-54033	76	147-61026	128	147-61523	130	147-62291	37	151-21032	120
147-47080	38	147-54034	76	147-61027	128	147-61550	129	147-62292	37	151-21033	120
147-47081	38	147-54062	75	147-61028	128	147-62020	36	147-62295	37	151-21034	120
147-47090	40	147-54102	75	147-61029	128	147-62021	36	147-62300	43	151-21035	120
147-47091	40	147-54104	75	147-61030	128	147-62025	36	147-62302	43	151-21036	120
147-47200	39	147-54105	75	147-61031	128	147-62026	36	147-62312	43	151-21037	120
147-47201	39	147-54106	75	147-61040	130	147-62072	35	147-62314	43	151-21050	121
147-47311	44	147-54107	75	147-61041	130	147-62074	35	147-62350	43	151-21051	121
147-47320	44	147-54108	75	147-61042	130	147-62075	35	147-62352	43	151-21052	121
147-48000	76	147-54109	75	147-61043	130	147-62095	37	147-62400	34	151-21053	121
147-48001	76	147-54110	75	147-61044	130	147-62105	33	147-62401	34	151-21054	121
147-48002	76	147-54112	75	147-61045	130	147-62106	33	147-62402	34	151-21055	121
147-48003	76	147-54113	75	147-61046	130	147-62107	33	147-62404	34	151-21300	92
147-48004	76	147-54114	75	147-61050	128	147-62140	33	147-62405	34	151-21301	92
147-48005	76	147-54115	75	147-61051	128	147-62141	33	147-62406	34	151-21302	92
147-48010	76	147-54116	75	147-61052	128	147-62200*	34	147-62410	34	151-21303	92
147-48011	76	147-54117	75	147-61053	128	147-62201	34	147-62411	34	151-21310	92
147-48012	76	147-54118	75	147-61204	129	147-62202	34	147-62412	34	151-21311	92
147-48013	76	147-54121	75	147-61205	129	147-62203	34	147-62414	34	151-21312	92
147-48014	76	147-54122	75	147-61220	129	147-62204	34	147-62415	34	151-21313	92
147-48015	76	147-54125	75	147-61220	165	147-62206	36	147-62416	34	151-21400	92
147-48016	76	147-54127	75	147-61221	129	147-62210*	35	147-62460	32	151-21401	92
147-48017	76	147-58000	73	147-61221	165	147-62211	35	147-64000	157	151-21402	92
147-48019	76	147-58001	73	147-61222	129	147-62212	35	153-65999	84	151-21403	92
147-48020	76	147-58002	73	147-61222	165	147-62213	35	147-66000	126	151-21410	92
147-48031	76	147-58003	73	147-61223	129	147-62214	35	147-66001	126	151-21411	92
147-48032	76	147-58020	73	147-61223	165	147-62216	36	147-66002	126	151-21412	92
147-48033	76	147-58021	73	147-61304	128	147-62220	34	147-68973	58	151-21413	92
147-48034	76	147-58022	73	147-61305	128	147-62221	34	147-77912	174	151-21420	92
147-54002	74	147-58023	73	147-61306	128	147-62222	34	147-77917	174	151-21421	92
147-54004	74	147-60000	73	147-61307	128	147-62223	34	147-77941	176	151-21422	92
147-54005	74	147-60001	73	147-61308	128	147-62230	35	147-77942	176	151-21423	92
147-54006	74	147-60002	73	147-61309	128	147-62231	35	147-77943	52	151-21430	93
147-54007	74	147-60003	73	147-61310	128	147-62232	35	147-77944	176	151-21431	93

Code	pg	Code	pg	Code	pg	Code	pg	Code	pg	Code	pg
151-21432	93	151-51342	95	160-56017	86	160-56323	90	500-22213	160	500-30253	169
151-21433	93	151-51343	95	160-56018	86	160-56324	90	500-22216	160	500-30254	169
151-21440	93	151-51344	95	160-56019	86	160-56330	89	500-22217	160	500-30255	169
151-21441	93	151-51345	95	160-56030	86	160-56331	89	500-22220	160	500-30256	169
151-21442	93	151-51346	95	160-56032	86	160-56332	89	500-22220	165	500-37000	147
151-21443	93	151-51350	95	160-56033	86	160-56333	89	500-22500	170	500-37001	147
151-21450	94	151-51351	95	160-56034	86	160-56334	89	500-22501	170	500-37002	147
151-21451	94	151-51352	95	160-56035	86	160-56335	89	500-22502	170	500-37003	147
151-21452	94	151-51353	95	160-56038	86	500-10000	162	500-30010	166	500-37004	147
151-21460	93	151-51360	95	160-56039	86	500-10001	162	500-30011	166	500-37010	147
151-21461	93	151-51361	95	160-56040	86	500-10002	162	500-30012	166	500-37012	147
151-21462	93	151-51362	95	160-56041	86	500-10003	162	500-30013	166	500-37013	147
151-21463	93	151-51363	95	160-56050	86	500-10004	162	500-30014	166	500-37020	147
151-21801	96	151-51370	94	160-56051	86	500-10005	162	500-30015	166	500-37021	147
151-21802	96	151-51371	94	160-56052	86	500-10006	162	500-30016	166	500-37022	147
151-21803	96	151-51372	94	160-56100	87	500-10007	162	500-30017	166	500-37023	147
151-21804	96	151-51373	94	160-56101	87	500-10010	163	500-30018	166	500-37024	147
151-21805	96	152-60679	174	160-56102	87	500-10011	163	500-30019	166	500-37100	158
151-21806	96	160-10000	90	160-56103	87	500-10012	163	500-30020	166	500-37101	158
151-21807	96	160-10001	90	160-56104	87	500-10013	163	500-30100	168	500-37102	158
151-21808	96	160-10002	90	160-56105	87	500-10014	163	500-30101	168	500-37110	158
151-21810	96	160-16000	91	160-56109	87	500-10015	163	500-30102	168	500-37111	158
151-21812	96	160-16001	91	160-56110	87	500-10016	163	500-30103	168	500-37112	158
151-21813	96	160-16002	90	160-56111	87	500-10017	163	500-30104	168	500-37120	158
151-21815	96	160-16003	90	160-56130	87	500-10020	162	500-30105	168	500-37121	158
151-21816	96	160-16004	90	160-56131	87	500-10021	162	500-30106	168	500-37122	158
151-21817	96	160-16005	91	160-56132	87	500-10022	162	500-30107	168	500-37123	158
151-51000	96	160-16006	91	160-56133	87	500-10023	162	500-30108	168	500-37124	158
151-51010	96	160-16007	91	160-56134	87	500-10024	162	500-30109	168	500-37125	158
151-51020	96	160-16008	91	160-56135	87	500-10025	162	500-30110	168	500-37150	158
151-51030	96	160-16010	91	160-56137	87	500-10026	163	500-30111	168	500-37151	158
151-51100	96	160-16011	91	160-56138	87	500-10027	163	500-30112	168	500-37160	170
151-51101	96	160-16012	90	160-56139	87	500-12113	170	500-30113	168	500-37300	170
151-51102	96	160-16013	90	160-56150	86	500-16000	157	500-30114	168	500-37500	145
151-51109	96	160-16014	91	160-56151	86	500-22000	156	500-30115	168	500-37501	145
151-51310	94	160-56000	86	160-56152	86	500-22001	156	500-30200	167	500-37502	145
151-51311	94	160-56001	86	160-56300	88	500-22002	156	500-30201	167	500-37503	145
151-51312	94	160-56002	86	160-56301	89	500-22002	165	500-30202	167	500-37510	145
151-51313	94	160-56003	86	160-56310	88	500-22003	156	500-30203	167	500-37511	145
151-51314	94	160-56004	86	160-56311	88	500-22003	165	500-30210	167	500-37512	145
151-51315	94	160-56005	86	160-56312	88	500-22004	156	500-30211	167	500-37513	145
151-51316	94	160-56009	86	160-56313	88	500-22004	165	500-30220	167	500-37514	145
151-51320	94	160-56010	86	160-56314	88	500-22005	156	500-30230	167	500-37515	145
151-51321	94	160-56011	86	160-56315	88	500-22012	156	500-30231	167	500-37520	145
151-51322	94	160-56013	86	160-56316	88	500-22202	160	500-30232	167	500-37521	145
151-51323	94	160-56014	86	160-56320	90	500-22203	160	500-30250	169	500-37522	145
151-51340	95	160-56015	86	160-56321	90	500-22204	160	500-30251	169	500-37523	145
151-51341	95	160-56016	86	160-56322	90	500-22211	160	500-30252	169	500-37530	145

ΕΥΡΕΤΗΡΙΟ ΚΩΔΙΚΩΝ  
CODE INDEX

Code	pg	Code	pg	Code	pg	Code	pg	Code	pg	Code	pg
500-37531	145	500-43003	137	500-43141	135	500-43254	139	500-43545	151	800-10039	24
500-37532	145	500-43004	137	500-43142	135	500-43255	139	500-43546	151		
500-37533	145	500-43005	137	500-43143	135	500-43256	139	500-43550	151		
500-37534	145	500-43006	137	500-43144	135	500-43257	139	500-43551	151		
500-37535	145	500-43007	137	500-43145	135	500-43258	139	500-43552	151		
500-37540	145	500-43008	137	500-43146	135	500-43259	139	500-43553	151		
500-37545	145	500-43010	137	500-43170	137	500-43260	139	500-43554	151		
500-39001	156	500-43011	137	500-43171	137	500-43300	141	500-43555	151		
500-39002	156	500-43012	137	500-43172	137	500-43301	141	500-43556	151		
500-39003	156	500-43013	137	500-43173	137	500-43302	141	500-43560	153		
500-39005	156	500-43014	137	500-43174	137	500-43303	141	500-43561	153		
500-42150	155	500-43015	137	500-43175	137	500-43310	141	500-43562	153		
500-42151	155	500-43016	137	500-43176	137	500-43311	141	500-43563	153		
500-42152	155	500-43017	137	500-43177	137	500-43312	141	500-43564	153		
500-42153	155	500-43018	137	500-43178	137	500-43313	141	500-43565	153		
500-42154	155	500-43020	137	500-43179	137	500-43500	149	500-43566	153		
500-42155	155	500-43021	137	500-43180	137	500-43501	149	500-43600	143		
500-42156	155	500-43022	137	500-43200	139	500-43502	149	500-43601	143		
500-42160	170	500-43023	137	500-43201	139	500-43503	149	500-43602	143		
500-42161	170	500-43024	137	500-43202	139	500-43504	149	500-43603	143		
500-42300	133	500-43025	137	500-43203	139	500-43505	149	500-43604	143		
500-42301	133	500-43026	137	500-43204	139	500-43506	149	500-43605	143		
500-42302	133	500-43027	137	500-43205	139	500-43510	149	500-43606	143		
500-42303	133	500-43028	137	500-43206	139	500-43511	149	500-43607	143		
500-42304	133	500-43040	137	500-43207	139	500-43512	149	500-43608	143		
500-42305	133	500-43041	137	500-43208	139	500-43513	149	500-43609	143		
500-42306	133	500-43042	137	500-43210	139	500-43514	149	500-43610	143		
500-42307	133	500-43043	137	500-43211	139	500-43515	149	500-43611	143		
500-42308	133	500-43044	137	500-43212	139	500-43516	149	500-43612	143		
500-42310	133	500-43045	137	500-43213	139	500-43520	151	500-43613	143		
500-42311	133	500-43100	135	500-43214	139	500-43521	151	500-43614	143		
500-42312	133	500-43101	135	500-43215	139	500-43522	151	500-43615	143		
500-42313	133	500-43102	135	500-43216	139	500-43523	151	500-43640	161		
500-42314	133	500-43103	135	500-43217	139	500-43524	151	500-43641	161		
500-42315	133	500-43104	135	500-43218	139	500-43525	151	500-43642	161		
500-42320	133	500-43105	135	500-43230	139	500-43526	151	500-45102	165		
500-42321	133	500-43120	135	500-43231	139	500-43530	151	500-45103	165		
500-42322	133	500-43121	135	500-43232	139	500-43531	151	500-45104	165		
500-42323	133	500-43122	135	500-43233	139	500-43532	151	500-45105	165		
500-42324	133	500-43123	135	500-43234	139	500-43533	151	500-45300	153		
500-42325	133	500-43124	135	500-43235	139	500-43534	151	500-45301	153		
500-42900	172	500-43125	135	500-43236	139	500-43535	151	500-45302	153		
500-42910	172	500-43126	135	500-43237	139	500-43536	151	500-45303	153		
500-42911	172	500-43127	135	500-43238	139	500-43540	151	500-45500	165		
500-42912	172	500-43128	135	500-43250	139	500-43541	151	500-45600	165		
500-43000	137	500-43138	135	500-43251	139	500-43542	151	800-10023	24		
500-43001	137	500-43139	135	500-43252	139	500-43543	151	800-10024	24		
500-43002	137	500-43140	135	500-43253	139	500-43544	151	800-10038	24		





# EUROLAMP®

**EUROLAMP S.A.**  
3rd km Symmachiki road,  
57013 Oreokastro  
Thessaloniki, Greece

T. +30 2310 574802  
info@eurolamp.gr

eurolamp.gr

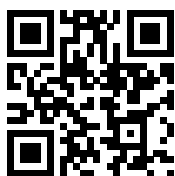

SHOP & FOLLOW

