



The Art of Illumination

FEDE
SWITCH & LIGHT

download catalogue



<https://fedeswitchandlight.com/catalogues/>



follow us



@fedebcn.official



[linkedin.com/company/fede](https://www.linkedin.com/company/fede)



@fedebcnofficial



@fedeswitchandlight

INDEX

NEW DESIGN	2
ARCHITECTS & DESIGNERS	5
ROUND COLLECTION	6
STUDIO COLLECTION	10
TWENTY COLLECTION	14
ATELIER COLLECTION	18
FLEX & POINT COLLECTION	22
DESIGN YOUR LIGHT SWITCH	30
SWITCH PLATES	32
ELECTRICAL MECHANISMS	34
TECHNICAL DATA	63

NEW DESIGN

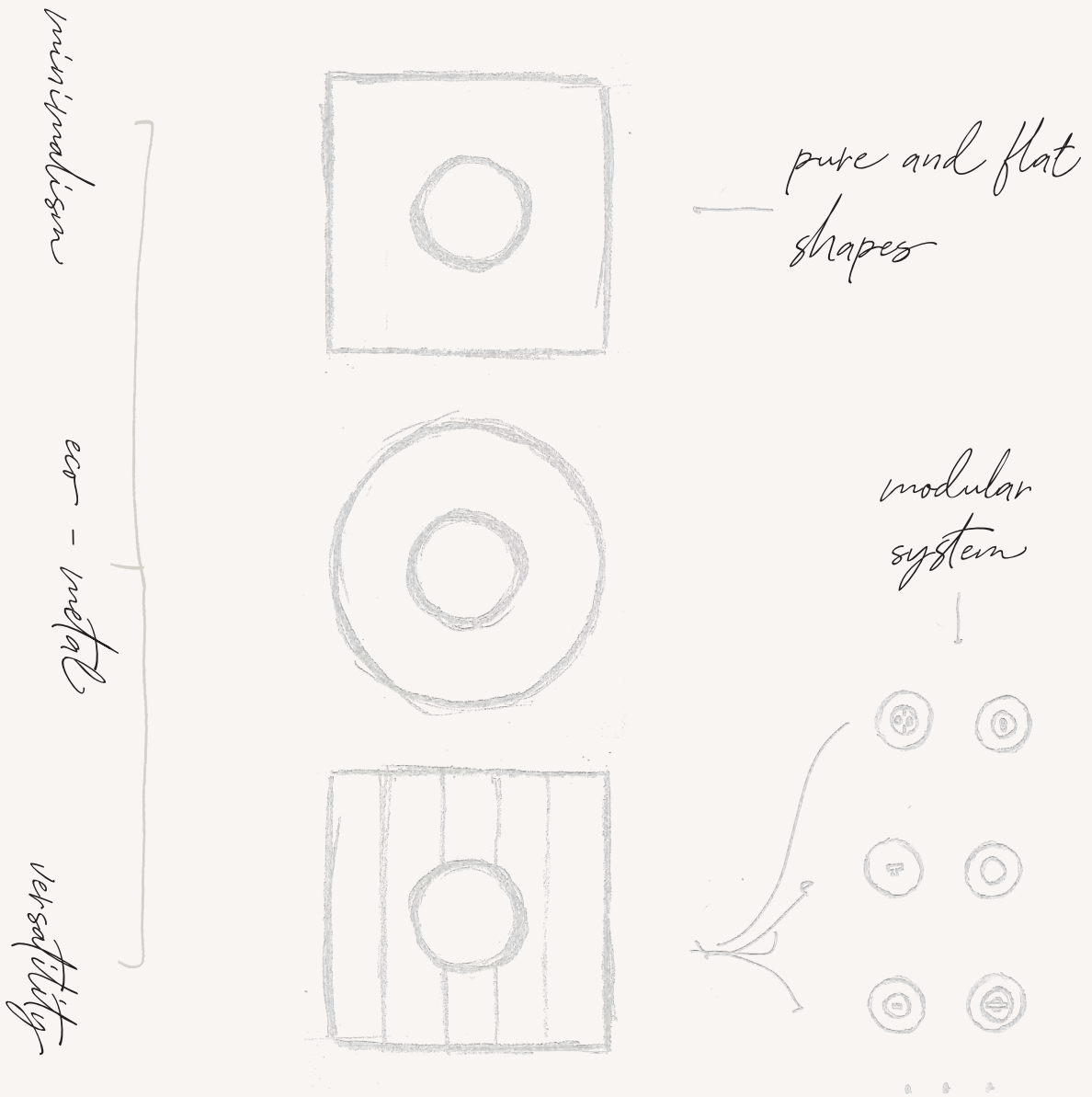

BY FEDE

INSPIRATION

universality

MODULAR SYSTEM
ELEGANCE FOR
ALL YOUR PROJECTS

minimalism

NEW ECO MATERIALS
INNOVATION
SIMPLICITY

art lovers

PURE GEOMETRY
TOP FINISHES
LUXURY EXPERIENCE

bespoke

CUSTOM-MADE
NEW DESIGN CONCEPTS
HANDMADE

TRENDS



THE ART OF ILLUMINATION

FEDE light switches are manufactured at our workshops located in Barcelona, Spain. Our highly specialized team of artisans polishes, performs exclusive finishes, and varnishes our collections with great care.

Our manufacture is The ART of illumination by FEDE.

ARCHITECTS



IZASKUN CHINCHILLA



CUARTO INTERIOR



SOMOS 2 STUDIO



NOMETRI STUDIO



EVA CHEUNG



ISA DE LUCA



XAVIER MARTIN



JORDI CUENCA



SIMONE MICHELI



SELLA CONCEPT



CRISTIANE BARBOSA



SHEILA DE MIGUEL

& DESIGNERS

ROUND

COLLECTION



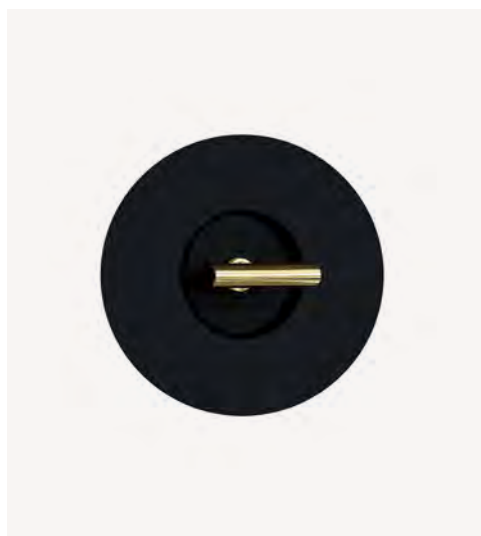
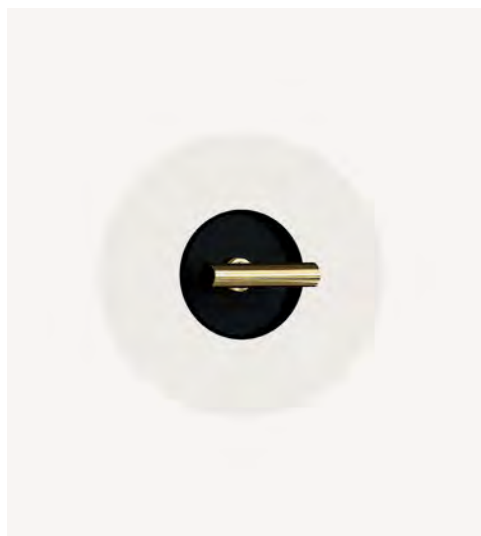



ROUND

COLLECTION

The rounded shapes were always there, but for the last years, they have been the trend among Architects and Designers.

Delicate, soft and very charming. This is how our round light switches are the Top selection in the world of decoration. They provide an organic style and ergonomic, as well as elegant, sophisticated and full of personality to your spaces.

You can find them in matte finishes and made of high-quality aluminum.

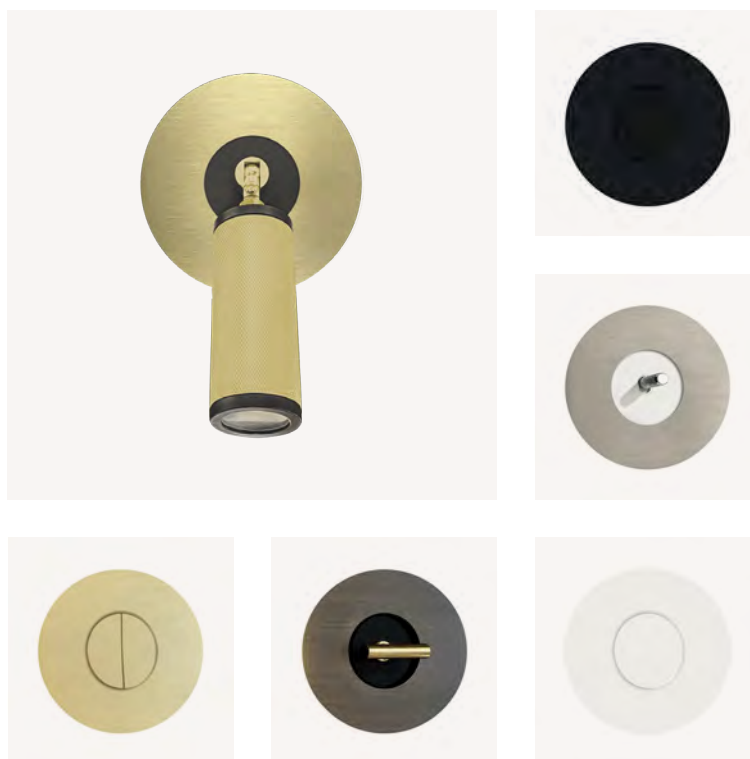

95x95x4 mm 95x166x4 mm 95x237x4 mm 95x308x4 mm 95x379x4 mm

MATTE BLACK	●	FD01901BK	FD01902BK	FD01903BK	FD01904BK	FD01905BK
MATTE WHITE	○	FD01901WH	FD01902WH	FD01903WH	FD01904WH	FD01905WH
SATIN MATTE GOLD	●	FD01901SMG	FD01902SMG	FD01903SMG	FD01904SMG	FD01905SMG
SOFT MATTE PATINA	●	FD01901SMP	FD01902SMP	FD01903SMP	FD01904SMP	FD01905SMP
SATIN MATTE NICKEL	●	FD01901SMN	FD01902SMN	FD01903SMN	FD01904SMN	FD01905SMN



STUDIO

COLLECTION

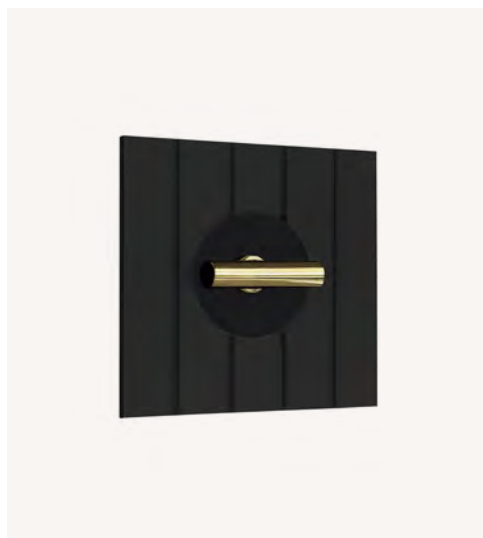
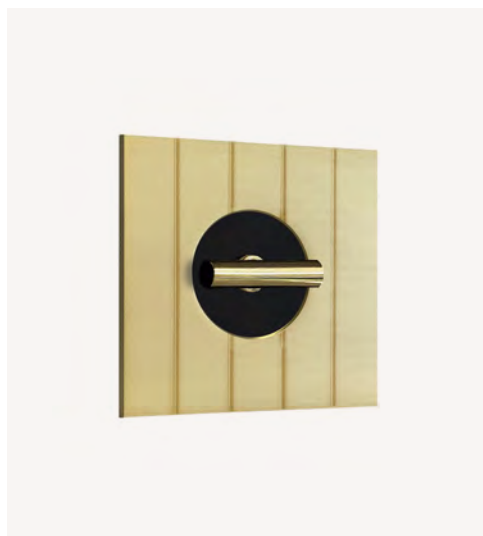

A minimalist bathroom interior with white fixtures and a marble floor. The scene is dimly lit, with two pairs of recessed ceiling lights. In the foreground, there are two white cylindrical pedestals. In the background, there are two arched mirrors, a white bidet, and a white toilet. The floor is covered in a light-colored marble with a network of thin, dark veins.

STUDIO

COLLECTION

From design focused on Retail to the most curated residential interior design, stripes are back in fashion, with no boundaries.

At FEDE we have rescued this trend and merged it with our more minimalist light switches, matte finishes and all made of aluminum.



87x87x4 mm

87x158x4 mm

87x229x4 mm

87x300x4 mm

87x371x4 mm

MATTE BLACK ●

FD01801BK

FD01802BK

FD01803BK

FD01804BK

FD01805BK

MATTE WHITE ○

FD01801WH

FD01802WH

FD01803WH

FD01804WH

FD01805WH

SATIN MATTE GOLD ●

FD01801SMG

FD01802SMG

FD01803SMG

FD01804SMG

FD01805SMG

SOFT MATTE PATINA ●

FD01801SMP

FD01802SMP

FD01803SMP

FD01804SMP

FD01805SMP

SATIN MATTE NICKEL ●

FD01801SMN

FD01802SMN

FD01803SMN

FD01804SMN

FD01805SMN



TWENTY

COLLECTION

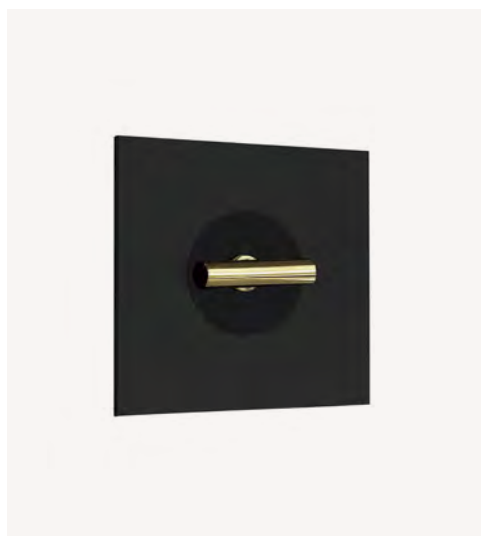



TWENTY

COLLECTION

We transform Top Quality aluminum sheets into smart frames in trendy matte finishes: white, black, satin matte gold, satin matte nickel and soft matte patina.

Less is more once again... Our craftsmen with their years of experience, artistic eye and incredible skills have created these original matte finishes to make your decor unique.

The timeless beauty and ability to be perfectly matched with any colour scheme means the new Twenty light switch collection is a “must have” for your next interior design project.



87x87x4 mm

87x158x4 mm

87x229x4 mm

87x300x4 mm

87x371x4 mm

MATTE BLACK



FD02001BK

FD02002BK

FD02003BK

FD02004BK

FD02005BK

MATTE WHITE



FD02001WH

FD02002WH

FD02003WH

FD02004WH

FD02005WH

SATIN MATTE GOLD



FD02001SMG

FD02002SMG

FD02003SMG

FD02004SMG

FD02005SMG

SOFT MATTE PATINA



FD02001SMP

FD02002SMP

FD02003SMP

FD02004SMP

FD02005SMP

SATIN MATTE NICKEL



FD02001SMN

FD02002SMN

FD02003SMN

FD02004SMN

FD02005SMN



ATELIER

COLLECTION

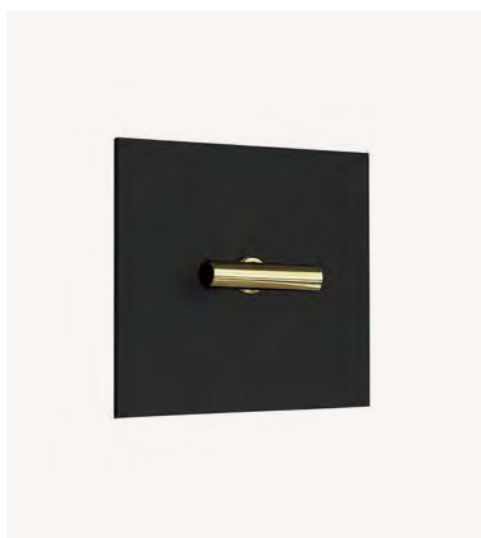
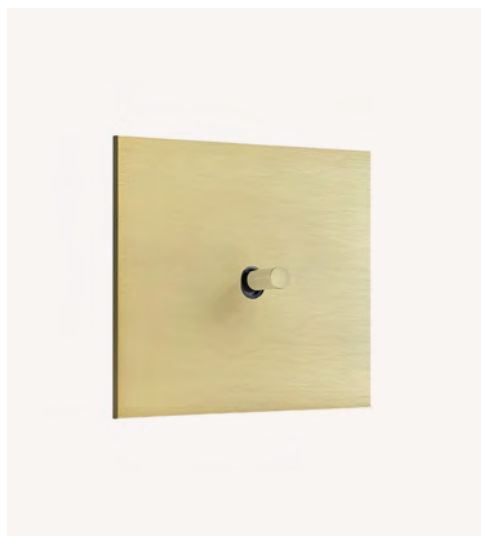

ATELIER

COLLECTION

The evolution of the Round and Twenty light switch collections towards a purer state.

Now both frames lose their modular condition, but gain a completely flat surface that provides an unprecedented design.

Our design team, always looking for solutions, now works CUSTOM MADE.

Each project is configured in a unique and exclusive way.



					
					
	87x87x4 mm	87x158x4 mm	87x229x4 mm	87x300x4 mm	87x371x4 mm
	95x95x4 mm	95x166x4 mm	95x237x4 mm	95x308x4 mm	95x379x4 mm
MATTE BLACK ●	□ FD02101BK ○ FD02201BK	□ FD02102BK ○ FD02202BK	□ FD02103BK ○ FD02203BK	□ FD02104BK ○ FD02204BK	□ FD02105BK ○ FD02205BK
MATTE WHITE ○	□ FD02101WH ○ FD02201WH	□ FD02102WH ○ FD02202WH	□ FD02103WH ○ FD02203WH	□ FD02104WH ○ FD02204WH	□ FD02105WH ○ FD02205WH
SATIN MATTE GOLD ●	□ FD02101SMG ○ FD02201SMG	□ FD02102SMG ○ FD02202SMG	□ FD02103SMG ○ FD02203SMG	□ FD02104SMG ○ FD02204SMG	□ FD02105SMG ○ FD02205SMG
SOFT MATTE PATINA ●	□ FD02101SMP ○ FD02201SMP	□ FD02102SMP ○ FD02202SMP	□ FD02103SMP ○ FD02203SMP	□ FD02104SMP ○ FD02204SMP	□ FD02105SMP ○ FD02205SMP
SATIN MATTE NICKEL ●	□ FD02101SMN ○ FD02201SMN	□ FD02102SMN ○ FD02202SMN	□ FD02103SMN ○ FD02203SMN	□ FD02104SMN ○ FD02204SMN	□ FD02105SMN ○ FD02205SMN



FLEX & POINT

READING LIGHTS COLLECTIONS



FLEX

COLLECTION

Let's play with our new FLEX Reading lights for your Home Decor or Hotel project!

Your walls are asking for good vibes and therefore we have created the best lighting solution for your project: FLEX Lights to direct the light as you want! With this collection we incorporate the best of two worlds: the functionality of FLEX design and the contemporary look.



Our adjustable FLEX reading lamps incorporate the LED latest generation lighting technology with built-in drivers that can be directly connected, thus easy to install in a standard box, like our high-end light switches.

You can move our lighting fixture to direct the light when you need it. It incorporates a 2.6W direct Bipin G9 LED LAMP at 230V and a colour temperature of 2700°K, to create a cozy atmosphere. It also includes a matte glass to maintain a good lighting uniformity for a great light effect.





-  95x95x4 mm
-  87x87x4 mm
-  87x87x4 mm

- MATTE BLACK ●
-  FDF01901-4-1BK
 -  FDF01801-4-1BK
 -  FDF02001-4-1BK

- MATTE WHITE ○
-  FDF01901-4-1WH
 -  FDF01801-4-1WH
 -  FDF02001-4-1WH

- SATIN MATTE GOLD ●
-  FDF01901-4-1SMG
 -  FDF01801-4-1SMG
 -  FDF02001-4-1SMG

- SOFT MATTE PATINA ●
-  FDF01901-4-1SMP
 -  FDF01801-4-1SMP
 -  FDF02001-4-1SMP

- SATIN MATTE NICKEL ●
-  FDF01901-4-1SMN
 -  FDF01801-4-1SMN
 -  FDF02001-4-1SMN

FLEX COLLECTION



OTHER SHAPES



 95x95x4 mm



 87x87x4 mm



 87x87x4 mm

MATTE BLACK ●  FDF01901-5-1BK
 FDF01801-5-1BK
 FDF02001-5-1BK

MATTE WHITE ○  FDF01901-5-1WH
 FDF01801-5-1WH
 FDF02001-5-1WH

SATIN MATTE GOLD ●  FDF01901-5-1SMG
 FDF01801-5-1SMG
 FDF02001-5-1SMG

SOFT MATTE PATINA ●  FDF01901-5-1SMP
 FDF01801-5-1SMP
 FDF02001-5-1SMP



SATIN MATTE NICKEL ●  FDF01901-5-1SMN
 FDF01801-5-1SMN
 FDF02001-5-1SMN



 95x95x4 mm



 87x87x4 mm



 87x87x4 mm

MATTE BLACK ●  FDF01901-1-1BK
 FDF01801-1-1BK
 FDF02001-1-1BK

MATTE WHITE ○  FDF01901-1-1WH
 FDF01801-1-1WH
 FDF02001-1-1WH

SATIN MATTE GOLD ●  FDF01901-1-1SMG
 FDF01801-1-1SMG
 FDF02001-1-1SMG

SOFT MATTE PATINA ●  FDF01901-1-1SMP
 FDF01801-1-1SMP
 FDF02001-1-1SMP

SATIN MATTE NICKEL ●  FDF01901-1-1SMN
 FDF01801-1-1SMN
 FDF02001-1-1SMN



MATTE BLACK ● ○ FDF01901-2-1BK
 ○ FDF01801-2-1BK
 □ FDF02001-2-1BK

MATTE WHITE ○ ○ FDF01901-2-1WH
 ○ FDF01801-2-1WH
 □ FDF02001-2-1WH

SATIN MATTE GOLD ● ○ FDF01901-2-1SMG
 ○ FDF01801-2-1SMG
 □ FDF02001-2-1SMG

SOFT MATTE PATINA ● ○ FDF01901-2-1SMP
 ○ FDF01801-2-1SMP
 □ FDF02001-2-1SMP

SATIN MATTE NICKEL ● ○ FDF01901-2-1SMN
 ○ FDF01801-2-1SMN
 □ FDF02001-2-1SMN



MATTE BLACK ● ○ FDF01901-3-1BK
 ○ FDF01801-3-1BK
 □ FDF02001-3-1BK

MATTE WHITE ○ ○ FDF01901-3-1WH
 ○ FDF01801-3-1WH
 □ FDF02001-3-1WH

SATIN MATTE GOLD ● ○ FDF01901-3-1SMG
 ○ FDF01801-3-1SMG
 □ FDF02001-3-1SMG

SOFT MATTE PATINA ● ○ FDF01901-3-1SMP
 ○ FDF01801-3-1SMP
 □ FDF02001-3-1SMP

SATIN MATTE NICKEL ● ○ FDF01901-3-1SMN
 ○ FDF01801-3-1SMN
 □ FDF02001-3-1SMN



MATTE BLACK ● ○ FDF01901-6-1BK
 ○ FDF01801-6-1BK
 □ FDF02001-6-1BK

MATTE WHITE ○ ○ FDF01901-6-1WH
 ○ FDF01801-6-1WH
 □ FDF02001-6-1WH

SATIN MATTE GOLD ● ○ FDF01901-6-1SMG
 ○ FDF01801-6-1SMG
 □ FDF02001-6-1SMG

SOFT MATTE PATINA ● ○ FDF01901-6-1SMP
 ○ FDF01801-6-1SMP
 □ FDF02001-6-1SMP

SATIN MATTE NICKEL ● ○ FDF01901-6-1SMN
 ○ FDF01801-6-1SMN
 □ FDF02001-6-1SMN

The background of the advertisement is a grayscale photograph of a bedroom. On the left, a nightstand holds several books, including one titled 'The Impressionists at the Louvre'. A lamp with a white shade is mounted on the wall above the nightstand. In the center, a bed with a white headboard is visible. The overall atmosphere is clean and modern.

POINT

COLLECTION

Let's play with our new POINT Reading lights for your Home Decor or Hotel project!

Your walls are asking for good vibes and therefore we have created the best lighting solution for your project: POINT Lights to direct the light as you want!

With this collection we incorporate the best of two worlds: the functionality of POINT design and the contemporary look.

Our adjustable POINT reading lamps incorporate the LED latest generation lighting technology with built-in drivers that can be directly connected, thus easy to install in a standard box, like our high-end light switches. You can move our lighting fixture to direct the light when you need it. It incorporates a 2.6W direct Bipin G9 LED LAMP at 230V and a colour temperature of 2700°K, to create a cozy atmosphere. It also includes a matte glass to maintain a good lighting uniformity for a great light effect.



○ 95x95x4 mm

▨ 87x87x4 mm

□ 87x87x4 mm

MATTE BLACK ● ○ FDR01901-5-1BK
 ▨ FDR01801-5-1BK
 □ FDR02001-5-1BK

MATTE WHITE ○ ○ FDR01901-5-1WH
 ▨ FDR01801-5-1WH
 □ FDR02001-5-1WH

SATIN MATTE GOLD ● ○ FDR01901-5-1SMG
 ▨ FDR01801-5-1SMG
 □ FDR02001-5-1SMG



















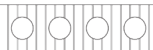



SOFT MATTE PATINA ● ○ FDR01901-5-1SMP
 ▨ FDR01801-5-1SMP
 □ FDR02001-5-1SMP

SATIN MATTE NICKEL ● ○ FDR01901-5-1SMN
 ▨ FDR01801-5-1SMN
 □ FDR02001-5-1SMN



TIME TO DESIGN YOUR
LIGHT SWITCH

1. CHOOSE YOUR SWITCH PLATE

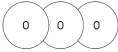
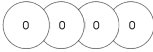
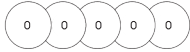
	1 gang	2 gangs	3 gangs	4 gangs	5 gangs
ROUND collection					
STUDIO collection					
TWENTY collection					
ATELIER collection					
					

2. CHOOSE THE SWITCH PLATE COLOUR



matte black



matte white



satin matte gold



soft matte patina



satin matte nickel

3. CHOOSE YOUR MECHANISMS



rocker switch



double rocker switches



toggle switch



double toggle switches



rotary switch



rotary dimmer



power socket



usb charger



tv/sat socket outlet



internet outlet

SWITCH PLATES

ROUND COLLECTION



FD01901BK
Matte Black



FD01901WH
Matte White



FD01901SMG
Satin Matte Gold



FD01901SMP
Soft Matte Patina



FD01901SMN
Satin Matte Nickel



FD01901BK-VC
Matte Black



95x95x4 mm



95x95x4 mm



95x166x4 mm



95x237x4 mm



95x308x4 mm



95x379x4 mm



FD01901BK

FD01901BK-VC

FD01902BK

FD01903BK

FD01904BK

FD01905BK



FD01901WH

FD01901WH-VC

FD01902WH

FD01903WH

FD01904WH

FD01905WH



FD01901SMG

FD01901SMG-VC

FD01902SMG

FD01903SMG

FD01904SMG

FD01905SMG



FD01901SMP

FD01901SMP-VC

FD01902SMP

FD01903SMP

FD01904SMP

FD01905SMP



FD01901SMN

FD01901SMN-VC

FD01902SMN

FD01903SMN

FD01904SMN

FD01905SMN

TWENTY COLLECTION



FD02001BK
Matte Black



FD02001WH
Matte White



FD02001SMG
Satin Matte Gold



FD02001SMP
Soft Matte Patina



FD02001SMN
Satin Matte Nickel

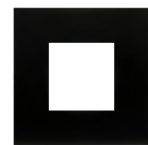

FD02001BK-VC
Matte Black



87x87x4 mm



87x87x4 mm



87x158x4 mm



87x229x4 mm



87x300x4 mm



87x371x4 mm



FD02001BK

FD02001BK-VC

FD02002BK

FD02003BK

FD02004BK

FD02005BK



FD02001WH

FD02001WH-VC

FD02002WH

FD02003WH

FD02004WH

FD02005WH



FD02001SMG

FD02001SMG-VC

FD02002SMG

FD02003SMG

FD02004SMG

FD02005SMG



FD02001SMP

FD02001SMP-VC

FD02002SMP

FD02003SMP

FD02004SMP

FD02005SMP



FD02001SMN

FD02001SMN-VC

FD02002SMN

FD02003SMN

FD02004SMN

FD02005SMN

STUDIO COLLECTION

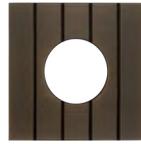
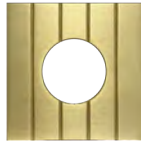

FD01801BK
Matte Black

FD01801WH
Matte White

FD01801SMG
Satin Matte Gold

FD01801SMP
Soft Matte Patina

FD01801SMN
Satin Matte Nickel

FD01801BK-VC
Matte Black



87x87x4 mm

87x87x4 mm

87x158x4 mm

87x229x4 mm

87x300x4 mm

87x371x4 mm



FD01801BK

FD01801BK-VC

FD01802BK

FD01803BK

FD01804BK

FD01805BK



FD01801WH

FD01801WH-VC

FD01802WH

FD01803WH

FD01804WH

FD01805WH



FD01801SMG

FD01801SMG-VC

FD01802SMG

FD01803SMG

FD01804SMG

FD01805SMG



FD01801SMP

FD01801SMP-VC

FD01802SMP

FD01803SMP

FD01804SMP

FD01805SMP



FD01801SMN

FD01801SMN-VC

FD01802SMN

FD01803SMN

FD01804SMN

FD01805SMN

ATELIER COLLECTION

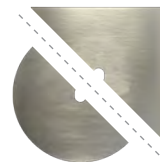
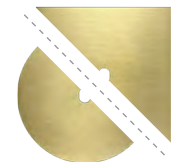

FD02101BK
Matte Black

FD02101WH
Matte White

FD02101SMG
Satin Matte Gold

FD02101SMP
Soft Matte Patina

FD02101SMN
Satin Matte Nickel



87x87x4 mm

87x158x4 mm

87x229x4 mm

87x300x4 mm

87x371x4 mm



95x95x4 mm

95x166x4 mm

95x237x4 mm

95x308x4 mm

95x379x4 mm



□ FD02101BK

□ FD02102BK

□ FD02103BK

□ FD02104BK

□ FD02105BK

○ FD02201BK

○ FD02202BK

○ FD02203BK

○ FD02204BK

○ FD02205BK



□ FD02101WH

□ FD02102WH

□ FD02103WH

□ FD02104WH

□ FD02105WH

○ FD02201WH

○ FD02202WH

○ FD02203WH

○ FD02204WH

○ FD02205WH



□ FD02101SMG

□ FD02102SMG

□ FD02103SMG

□ FD02104SMG

□ FD02105SMG

○ FD02201SMG

○ FD02202SMG

○ FD02203SMG

○ FD02204SMG

○ FD02205SMG



□ FD02101SMP

□ FD02102SMP

□ FD02103SMP

□ FD02104SMP

□ FD02105SMP

○ FD02201SMP

○ FD02202SMP

○ FD02203SMP

○ FD02204SMP

○ FD02205SMP



□ FD02101SMN

□ FD02102SMN

□ FD02103SMN

□ FD02104SMN

□ FD02105SMN

○ FD02201SMN

○ FD02202SMN

○ FD02203SMN

○ FD02204SMN

○ FD02205SMN

MECHANISMS

ROCKER SWITCH & PUSH BUTTON FOR SMART HOME

WIDE KEYS



FD05310BK
Matte Black

FD05310WH
Matte White

FD05310SMG
Satin Matte Gold

FD05310SMP
Soft Matte Patina

FD05310SMN
Satin Matte Nickel

KEYS			FIXING SUPPORT	MECHANISM	
BRASS	●	FD05310BK	FD20-BAST	FD16505	FD16559
BRASS	○	FD05310WH		FD16506	FD16508
BRASS	●	FD05310SMG		FD16507	FD16558
BRASS	●	FD05310SMP		FD16605	FD15516
BRASS	●	FD05310SMN		FD16557	
PLASTIC	●	FD19705-M			
PLASTIC	○	FD19705			

To create your one-key light switch, please choose the switch plate collection, the key finish, along with the fixing support and mechanism codes. For example: FD01901SMP + FD05310SMP + FD20-BAST + FD16505

WITH LED INDICATORS

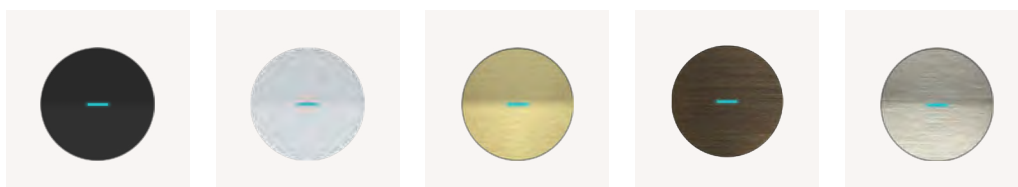

FD05312BK
Matte Black

FD05312WH
Matte White

FD05312SMG
Satin Matte Gold

FD05312SMP
Soft Matte Patina

FD05312SMN
Satin Matte Nickel

KEYS			FIXING SUPPORT	MECHANISM		LED INDICATOR
BRASS	●	FD05312BK	FD20-BAST	FD16505	FD16559	For DP switches and intermediate switches FD21139-1
BRASS	○	FD05312WH		FD16506	FD16508	
BRASS	●	FD05312SMG		FD16507	FD16558	
BRASS	●	FD05312SMP		FD16605	FD16516	For SP switches, push buttons and two-way switches FD21139-2
BRASS	●	FD05312SMN		FD16557		
PLASTIC	●	FD19705-ML				
PLASTIC	○	FD19705-L				

To create your one-key light switch with led indicator, please choose the switch plate collection, the key finish, along with the fixing support, mechanism and led indicator codes. For example: FD01901SMN + FD05312SMN + FD20-BAST + FD16505 + FD21139-2

N A R R O W K E Y S

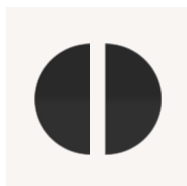

FD05311BK
Matte Black

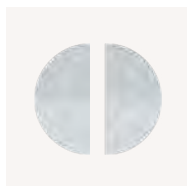

FD05311WH
Matte White



FD05311SMG
Satin Matte Gold

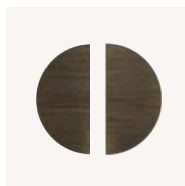

FD05311SMP
Soft Matte Patina



FD05311SMN
Satin Matte Nickel

KEYS			FIXING SUPPORT	MECHANISM	
BRASS	●	FD05311BK -I / D	FD20-BAST	2 x FD16505	2 x FD16559
BRASS	○	FD05311WH -I / D		2 x FD16506	2 x FD16508
BRASS	●	FD05311SMG -I / D		2 x FD16507	2 x FD16558
BRASS	●	FD05311SMP -I / D		2 x FD16605	2 x FD16516
BRASS	●	FD05311SMN -I / D		2 x FD16557	
PLASTIC	●	FD18705-IM / DM			
PLASTIC	○	FD18705 -I / D			

To create your double key light switch, please choose the switch plate collection, the keys finishes, along with the fixing support, mechanisms and led indicators codes. For example: FD01901SMN + FD05311SMN-I + FD05311SMN-D + FD20-BAST + 2 x FD16505

W I T H L E D I N D I C A T O R S

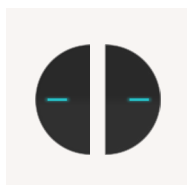

FD05313BK
Matte Black

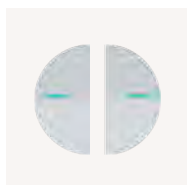

FD05313WH
Matte White

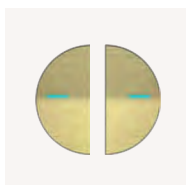

FD05313SMG
Satin Matte Gold

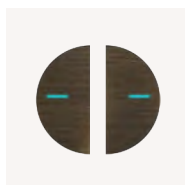

FD05313SMP
Soft Matte Patina

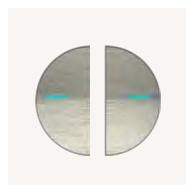

FD05313SMN
Satin Matte Nickel

KEYS			FIXING SUPPORT	MECHANISM		LED INDICATOR
BRASS	●	FD05313BK -I / D	FD20-BAST	2 x FD16505	2 x FD16559	for DP switches and intermediate switches 2 x FD21139-1
BRASS	○	FD05313WH -I / D		2 x FD16506	2 x FD16508	
BRASS	●	FD05313SMG -I / D		2 x FD16507	2 x FD16558	
BRASS	●	FD05313SMP -I / D		2 x FD16605	2 x FD16516	SP switches, push buttons and two-way switches 2 x FD21139-2
BRASS	●	FD05313SMN -I / D		2 x FD16557		
PLASTIC	●	FD18705-IML / DML				
PLASTIC	○	FD18705-IL / DL				

To create your double key light switch with led indicator, please choose the switch plate collection, the keys finishes, along with the fixing support, mechanisms and led indicators codes. For example: FD01901SMN + FD05313SMN-I + FD05313SMN-D + FD20-BAST + 2 x FD16505 + 2 x FD21139-2

DIMMER WIDE KEY

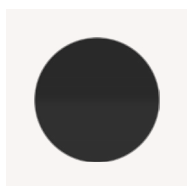

FD05310BK
Matte Black



FD05310WH
Matte White



FD05310SMG
Satin Matte Gold

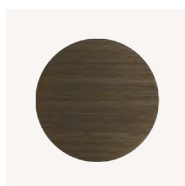

FD05310SMP
Soft Matte Patina



FD05310SMN
Satin Matte Nickel

KEYS			FIXING SUPPORT	PUSH BUTTON	DIMMER
BRASS	●	FD05310BK	FD20-BAST	FD16516	FD-LD220 (Power 200W)
BRASS	○	FD05310WH			
BRASS	●	FD05310SMG			
BRASS	●	FD05310SMP			FD-LD440 (Power 440 W)
BRASS	●	FD05310SMN			
PLASTIC	●	FD19705-M			
PLASTIC	○	FD19705			FD-LD220WCM (Bluetooth 200W)

To create your push button dimmer, please choose the switch plate collection, the key finish, along with the fixing support and dimmer codes. For example: FD01901SMN + FD05310SMN + FD20-BAST + FD16516 + FD-LD220

DIMMER NARROW KEYS



FD05311BK
Matte Black



FD05311WH
Matte White

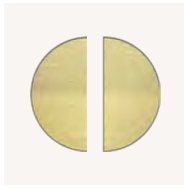

FD05311SMG
Satin Matte Gold



FD05311SMP
Soft Matte Patina



FD05311SMN
Satin Matte Nickel

KEYS			FIXING SUPPORT	PUSH BUTTON	DIMMER
BRASS	●	FD05311BK - I /D	FD20-BAST	2 x FD16516	FD-LD200KRON (Power 2 X 100 W)
BRASS	○	FD05311WH - I /D			
BRASS	●	FD05311SMG - I /D			
BRASS	●	FD05311SMP - I /D			
BRASS	●	FD05311SMN - I /D			
PLASTIC	●	FD18705-IM / DM			
PLASTIC	○	FD18705- I /D			

To create your push button double dimmer, please choose the switch plate collection, the keys finishes, along with the fixing support and dimmer codes. For example: FD01901SMN + FD05311SMN-I + FD05311SMN-D+ FD20-BAST + 2 x FD16516 + FD-LD220KRON

SINGLE TOGGLE SWITCH & DIMMER



Matte Black Matte White Satin Matte Gold Soft Matte Patina Satin Matte Nickel

COVERS		HANDLES	FIXING SUPPORT	MECHANISM	DIMMER *
BRASS	● FD04520BK	● FD02318BK-M	FD21-BAST	FD16505 FD16506 FD16507 FD16605 FD16557 FD16559 FD16508 FD16558 FD16516	FD-LD220 (Power 200W) FD-LD440 (Power 440 W) FD-LD220WCM (Bluetooth 200W)
		● FD02318BK-A			
BRASS	○ FD04520WH	○ FD02318WH-M			
		○ FD02318WH-A			
BRASS	● FD04520SMG	● FD02318SMG-M			
		● FD02318SMG-A			
BRASS	● FD04520SMP	● FD02318SMP-M			
		● FD02318SMP-A			
BRASS	● FD04520SMN	● FD02318SMN-M			
		● FD02318SMN-A			
PLASTIC	● FD04420P-M	● ○ ● ● ●			
PLASTIC	● FD04420P-A	● ○ ● ● ●			
PLASTIC	○ FD04420P	● ○ ● ● ●			

To create your toggle light switch, please choose the switch plate collection, the cover finish, along with the fixing support, the handles and mechanism codes. For example: FD01901SMN + FD04520SMN-M + FD02318SMN-M + FD21-BAST + FD16505

* The dimmer can only be used with the **FD16516** mechanism

SINGLE COVER TOGGLE



FD04520BK Matte Black **FD04520WH** Matte White **FD04520SMG** Satin Matte Gold **FD04520SMP** Soft Matte Patina **FD04520SMN** Satin Matte Nickel



FD04420P-M Black Plastic **FD04420P-A** Beige Plastic **FD04420P** White Plastic

DOUBLE TOGGLE SWITCH & DIMMER

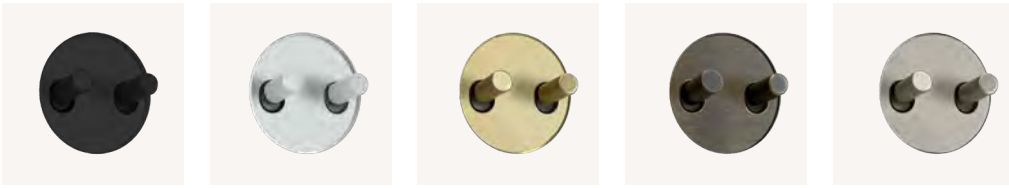

Matte Black

Matte White

Satin Matte Gold

Soft Matte Patina

Satin Matte Nickel

	COVERS	HANDLES	FIXING SUPPORT	MECHANISM	DIMMER *
BRASS	● FD04521BK	● 2 x FD02318BK-M ● 2 x FD02318BK-A	FD21-BAST	2 x FD16505 2 x FD16506 2 x FD16507 2 x FD16605 2 x FD16557 2 x FD16559 2 x FD16508 2 x FD16558 2 x FD16516	FD-LD200KRON (Power 2 X 100 W)
BRASS	○ FD04521WH	○ 2 x FD02318WH-M ○ 2 x FD02318WH-A			
BRASS	● FD04521SMG	● 2 x FD02318SMG-M ● 2 x FD02318SMG-A			
BRASS	● FD04521SMP	● 2 x FD02318SMP-M ● 2 x FD02318SMP-A			
BRASS	● FD04521SMN	● 2 x FD02318SMN-M ● 2 x FD02318SMN-A			
PLASTIC	● FD04421P-M	● ○ ● ● ●			
PLASTIC	● FD04421P-A	● ○ ● ● ●			
PLASTIC	○ FD04421P	● ○ ● ● ●			

To create your double toggle switch, please choose the switch plate collection, the handles finishes, along with the fixing support, mechanisms and led indicators codes. For example: FD01901SMN + 2 X FD02318SMN-M + FD04521SMN-M + FD21-BAST + 2 x FD16505

* The dimmer can only be used with the **FD16516** mechanism

DOUBLE COVERS TOGGLE



FD04521BK
Matte Black

FD04521WH
Matte White

FD04521SMG
Satin Matte Gold

FD04521SMP
Soft Matte Patina

FD04521SMN
Satin Matte Nickel

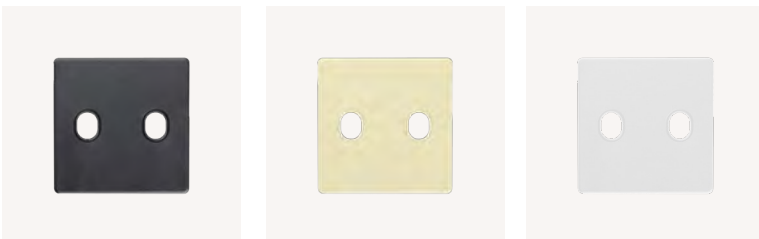

FD04421P-M
Black Plastic

FD04421P-A
Beige Plastic

FD04421P
White Plastic

LED TOGGLE SWITCH

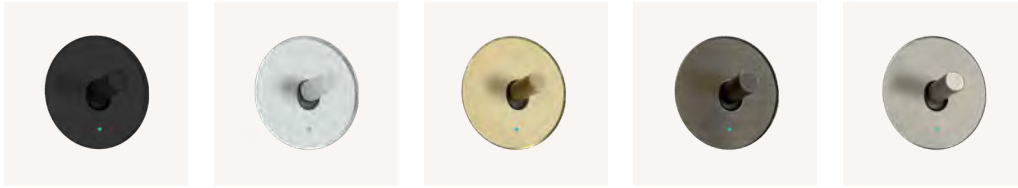

Matte Black Matte White Satin Matte Gold Soft Matte Patina Satin Matte Nickel

COVERS		HANDLES	FIXING SUPPORT	MECHANISM	LED INDICATOR
BRASS	● FD04520PD-BK	● FD02318BK-M	FD21-BAST	FD16505 FD16506 FD16507 FD16605 FD16557 FD16559 FD16508 FD16558 FD16516	FD21139-1 FD21139-2
		● FD02318BK-A			
BRASS	○ FD04520PD-WH	○ FD02318WH-M			
		○ FD02318WH-A			
BRASS	● FD04520PD-SMG	● FD02318SMG-M			
		● FD02318SMG-A			
BRASS	● FD04520PD-SMP	● FD02318SMP-M			
		● FD02318SMP-A			
BRASS	● FD04520PD-SMN	● FD02318SMN-M			
		● FD02318SMN-A			
PLASTIC	● FD04420PD-M	● ○ ● ● ●			
PLASTIC	● FD04420PD-A	● ○ ● ● ●			
PLASTIC	○ FD04420PD	● ○ ● ● ●			
TRANSPARENT		FD02317T-M			FD21138-1
		FD02317T-A			FD21138-2

To create your push button dimmer, please choose the switch plate collection, the handle finish, along with the fixing support and dimmer codes. For example: FD01901SMN + FD02318SMN-M + FD04520PD-SMN-M + FD21-BAST + FD16505 +(FD21139-2)

SINGLE COVER TOGGLE



FD04520PD-BK Matte Black **FD04520PD-WH** Matte White **FD04520PD-SMG** Satin Matte Gold **FD04520PD-SMP** Soft Matte Patina **FD04520PD-SMN** Satin Matte Nickel



FD04420PD-M Black Plastic **FD04420PD-A** Beige Plastic **FD04420PD** White Plastic

LED DOUBLE TOGGLE SWITCHES

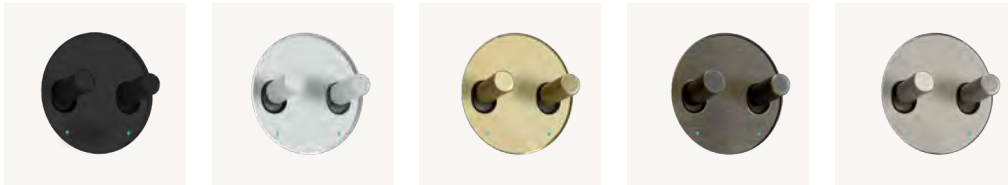

Matte Black Matte White Satin Matte Gold Soft Matte Patina Satin Matte Nickel

COVERS		HANDLES	FIXING SUPPORT	MECHANISM	LED INDICATOR	
BRASS	●	FD04521PD-BK	FD21-BAST	2 x FD16505 2 x FD16506 2 x FD16507 2 x FD16605 2 x FD16557 2 x FD16559 2 x FD16508 2 x FD16558 2 x FD16516	2 x FD21139-1 2 x FD21139-2	
		● 2 x FD02318BK-M				
BRASS	○	FD04521PD-WH				○ 2 x FD02318WH-M
		○ 2 x FD02318WH-A				
BRASS	●	FD04521PD-SMG				● 2 x FD02318SMG-M
		● 2 x FD02318SMG-A				
BRASS	●	FD04521PD-SMP				● 2 x FD02318SMP-M
		● 2 x FD02318SMP-A				
BRASS	●	FD04521PD-SMN				● 2 x FD02318SMN-M
		● 2 x FD02318SMN-A				
PLASTIC	●	FD04421PD-M	● ○ ● ● ●			
PLASTIC	●	FD04421PD-A	● ○ ● ● ●			
PLASTIC	○	FD04421PD	● ○ ● ● ●			
TRANSPARENT		FD02317T-M		2 x FD21138-1		
		FD02317T-A		2 x FD21138-2		

To create your push button double dimmer, please choose the switch plate collection, the handles finishes, along with the fixing support and dimmer codes. For example: FD01901SMN + 2 x FD02318SMN-M + FD04521PD-SMN-M + FD21-BAST + 2 x FD16505 +(2 x FD21139-2)

DOUBLE COVERS TOGGLE

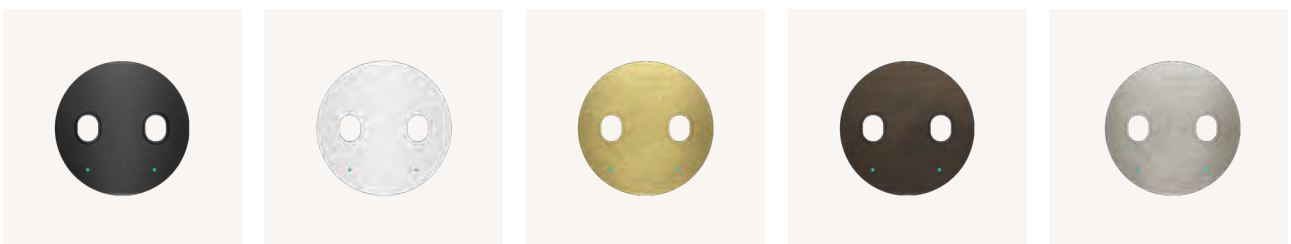

FD04521PD-BK Matte Black **FD04521PD-WH** Matte White **FD04521PD-SMG** Satin Matte Gold **FD04521PD-SMP** Soft Matte Patina **FD04521PD-SMN** Satin Matte Nickel



FD04421PD-M Black Plastic **FD04421PD-A** Beige Plastic **FD04421PD** White Plastic

NEW ATELIER TOGGLE HANDLE



FD02319BK-M
Matte Black | Black



FD02319WH-M
Matte White | Black



FD02319SMG-M
Satin Matte Gold | Black



FD02319SMP-M
Soft Matte Patina | Black



FD02319SMN-M
Satin Matte Nickel | Black

SOHO TOGGLE HANDLE



FD02318BK-M
Matte Black | Black



FD02318WH-A
Matte White | Beige



FD02318SMG-A
Satin Matte Gold | Beige



FD02318SMP-M
Soft Matte Patina | Black



FD02318SMN-A
Satin Matte Nickel | Beige

MARCO TOGGLE HANDLE



FD02317BK-M
Matte Black | Black



FD02317WH-M
Matte White | Black



FD02317SMG-M
Satin Matte Gold | Black

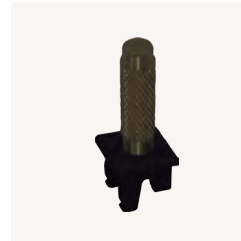

FD02317SMP-M
Soft Matte Patina | Black



FD02317SMN-M
Satin Matte Nickel | Black

CLASSIC TOGGLE HANDLE



FD2316BK-M
Matte Black | Black



FD2316WH-A
Matte White | Beige

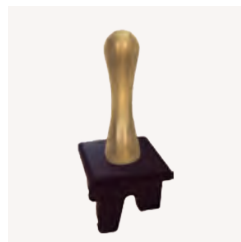

FD2316SMG-M
Satin Matte Gold | Black

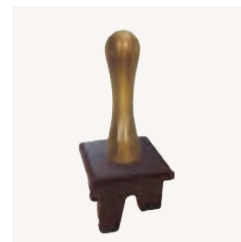

FD2316SMP-M
Soft Matte Patina | Black



FD2316SMN-M
Satin Matte Nickel | Black

LIGHT SWITCHES



FD16505
UNIPOLAR SWITCH
One-way SP switch
10A 250V~



FD16506
UNIPOLAR SWITCH
Two-way SP switch
10A 250V~



FD16507
UNIPOLAR SWITCH
Intermediate switch
10A 250V~



FD16605
UNIPOLAR SWITCH
Control one-way
10A 250V~



FD16557
UNIPOLAR SWITCH
One-way SP switch
16A 250V~



FD16559
UNIPOLAR SWITCH
Two-way SP switch
16A 250V~



FD16508
BIPOLAR SWITCH
One-way DP switch
10A 250V~



FD16558
BIPOLAR SWITCH
One-way DP switch
16A 250V~



FD16516
PUSH BUTTON
10A 250V~



FD16599
PUSH BUTTON
With temporized switch
and diffuser
Timing 3 min. max 500W 230V~

LED INDICATORS

transparent handles



FD21138-1
LIGHT INDICATOR
Blue LED indicator for
DP switches and inter-
mediate switches
230V ~ 1mA



FD21138-2
LIGHT INDICATOR
White LED indicator for
SP switches, push but-
tons and two-way switch-
es
230V ~ 1mA

for rocker & toggle switches



FD21139-1
LIGHT INDICATOR
Blue LED indicator for
DP switches and inter-
mediate switches
230V ~ 1mA



FD21139-2
LIGHT INDICATOR
White LED indicator for
SP switches, push but-
tons and two-way switch-
es
230V ~ 1mA



FD3139

ADDITIONAL RESISTANCE

When using a switch with LED, the additional resistance stops LED lights from flickering when switched off, while saving energy. The additional resistance installed eliminates the capacitor's leakage currents that cause lights to flicker when the power is switched off.

DIMMERS

for single light switch



FD-LD220

DIMMER FOR LED LAMP

Power: 200W
230V 50/60Hz

Installed in the mounting box behind the push button.
Dimensions: 56 x 22 mm



FD-LD440

DIMMER FOR LED LAMP

Power: 440W
230V 50/60Hz

Installed in the mounting box behind the push button.
Dimensions: 56 x 22 mm



FD-LD220WCM

DIMMER LED BLUETOOTH

Power: 200W
230V 50/60Hz

Installed in the mounting box behind the push button.
Dimensions: 50 x 15.5 mm



FD-LD200KRON

DIMMER LED 2 CHANNELS

Power: 2 x 100W
230V 50/60Hz

Installed in the mounting box behind the push button.
Dimensions: 57 x 21 mm

Universal LED-dimmers for wallbox installation that starts at 1W. The series of universal push dimmers starts already at 1W for dimming of both lowpower lamps as well as electronic transformers, dimmable LED-drivers and incandescent lamps.

Adjustable minimum dimming level. Depending on the type of load that is connected to the dimmer, the dimmer's lowest dimming level can be adjusted to fit the load in question.

Memory function. Equipped with memory function that also remains after power failure.

PROFESSIONAL LIGHT CONTROL WIRELESS CONTROL WITH BLUETOOTH SYSTEM

Complete control system · Wireless sync of all lighting · With integrated control for 1 to 10V &  Presence sensors, astro-feature and timer functions · Easily controlled with app and/or button

SYSTEM PARTS



FD-LD220WCM

DIMMER LED BLUETOOTH

The FDLD220WCM is a universal, back edge-controlled phase dimmer, which dims between 0 and 200 VA. The dimmer, consists of an astro-timer as well as the option of connecting a non-locking press button. Is extremely small, which means that there is plenty of space inside the box. It is also possible to deactivate the dimmer feature in order to operate non-dimmable loads.



FDCM10WCM

THE CONTROL DEVICE

The FDCM10WCM is a control device which converts the Bluetooth signal to between 0/1 and 10 V. This can be retro-fitted in the current system or, for instance, when you wish to install a more powerful dimmer in the system. In the DALI mode, there is support to broadcast, colour control and light temperature.



FDPWM4WCM

CONTROL DEVICE FOR COLOUR

The FDPWM4WCM is a control device that controls the colour of the light fittings and LED strings that are intended for RGBW control. RGBW is used, among other places, at restaurants, churches, and play areas to set the correct mood and draw interest. FDPWM4WCM can handle 144W/24V-dc and 72W/12Vdc.



FDSSW60WCM

THE DIGITAL ACTUATOR

Our Swedish-developed actuators now coexist with a unique product. With the SoftSwitcher FDSSW60WCM and, with its 32 three set settings for loads, it is possible to control/operate all the LED fittings and strings available in the market. FDSSW60WCM is a digital actuator that has enabled a compact design with its 60W.

WIRELESS CONTROL WITH CASAMBI

The system is based on the standardized Bluetooth protocol, which is integrated in the majority of today's smartphones and tablets. With app support for Android and Apple iOS, you can easily control your lighting, with complete dimming options through your smartphone. The system enables you to, for instance, control all light sources, downlights, LED strings, wall sockets, garage doors, Venetian blinds and much more. You can of course also control the system with a classic non-locking button.

THE APP

DIMMING USING THE APP

You get a simple, intuitive dim ring / device and light / extinguish function through the free Casambi app.

ASTRO-FEATURE & TIMER CONTROL

The astro-feature means that your lighting is activated by the sunrise and sunset. The astro-feature and timer controls are set through the app. The settings are thereafter stored in the dimmer memory, and work on the basis of the dimmer's internal clock, and function completely independently.

GROUPING AND SCENARIOS

Group your light sources through the app and dim/control them simultaneously. You can of course also set different scenarios in separate rooms. For instance, if you wish to turn off all the light sources, or dim only a certain set of light sources in a particular room. Everything is possible with the dimmer and the app. Only your imagination is the limit!

CONTROL OPTIONS

The app allows you to take pictures of your rooms, and then activate the light by placing your finger on a lamp. Unbelievably simple!

ACCESS AND SHARING SETTINGS

The first time your units are used, they are paired with a master unit (smartphone or tablet). The network or unit can thereafter be shared with other units. You can easily password-protect your network or leave it open for access. The internal communication between the dimmers is well protected through asymmetric keys or an encrypted schedule. You can also share the settings with your loved ones within the household in order for them to gain complete access to all the light control options. Simple and user-friendly.

BLUETOOTH SYSTEM

UNLIMITED REACH

By using MESH network technology, you only need to be within reach (usually 30 meters) of just one unit in order to control all of them. Communication takes place automatically between units within reach. The Bluetooth dimmer FDL220WCM is placed in a box and provides a natural dispersion of the network in the course of the installation.

NO ROUTER

The Bluetooth system does not require any external router, as all communication is saved in the Bluetooth cloud. This is cost effective, provides quick communication, and is very practical.

CONSTANTLY UPDATED UNITS

The software in your units can be easily updated by connecting to the network through your smartphone/tablet. This provides the units with the latest features and updates. The units update each other automatically when new firmware is uploaded.

SCALABLE SYSTEM

The FDL220WCM is included in the wireless system and can be integrated with products such as the FDSSW60WCM. Read more about each product on the next page.

GATEWAY FEATURE

By enabling gateway functionality on an existing iOS or Android device, you will be able to access your home while at work, at the beach or if you just want to support an existing customer with his/her installation. You do not need to buy an additional router, rather it is sufficient to have one unit in place that runs iOS or Android, such as a tablet etc.

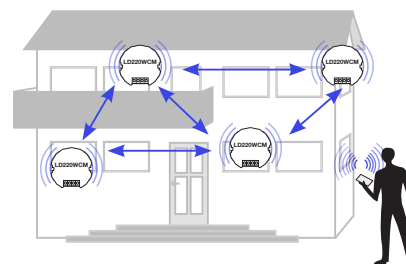

By using MESH networking technology, you only need to be within range (typically 30 meters) of a single unit to control all units.



PRACTICAL SYSTEM SOLUTIONS

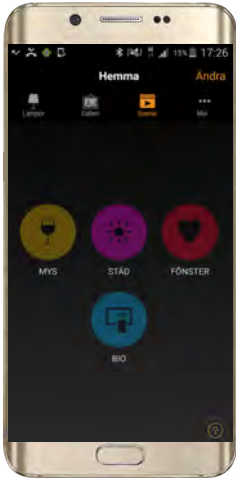

LIVING ROOM

Downlights, LED strings and light sources are controlled by the Bluetooth actuator, and become part of the system. Connect the non-locking press button, and specify in the app the action that you want to perform.



THE APP Large windows with daylight in daytime, need a matching scenario. The Astro-timer and schedule settings ensure that guests always enjoy the correct lighting.



SHOPS, RESTAURANTS AND PUBLIC ENVIRONMENTS

Control small and large lighting groups. The system is complete with dimmers from 0 to 2000 VA for LED lights. The installation is quick as unnecessary wiring and complicated programming are not required. The risk of unintended expenses also reduces. If you want to connect more lighting later, the integration will be quick and smooth.

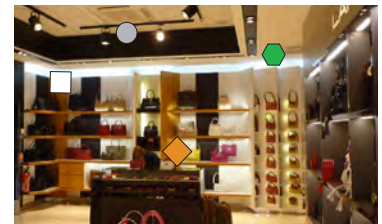

THE APP Light fittings and light sources with scenarios and animations get the customers and employees in the right mood. You create a vivid environment.

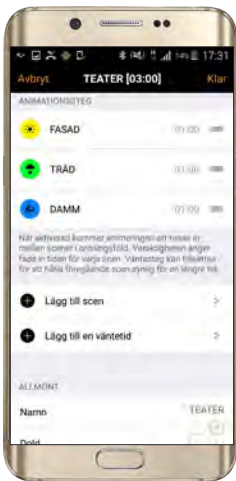

OUTDOOR LIGHTING

Connect wall lights, bollards and deck lights to the Bluetooth system, and have the same control outdoors, as indoors. Wireless synchronisation simplifies wiring.

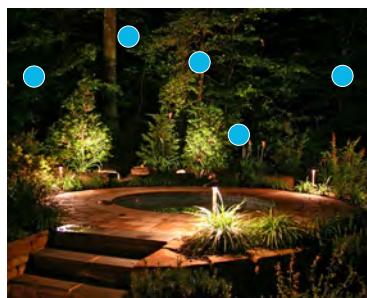

THE APP The astro-timer, scenarios and animations impress the neighbours, and frighten off uninvited guests.

- SSW60WCM
- MPRESS
- PWM4WCM
- LDD220WCM
- XPRESS
- CM10WCM

ROTARY DIMMER EMBOSSED BUTTON

* To change the plastic rotary handle to the brass rotary handle, simply replace the plastic one and put on a brass one. The plastic handle is included with the adjustment mechanism.



FD04336BK
Matte Black



FD04336WH
Matte White



FD04336SMG
Satin Matte Gold



FD04336SMP
Soft Matte Patina

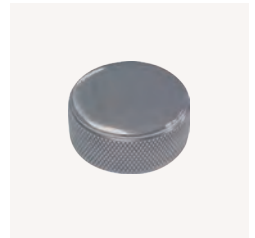

FD04336SMN
Satin Matte Nickel

		MECHANISM	KEYS	EMBOSSED BUTTON	FIXING SUPPORT
BRASS	●	FD16438BK-A	● FD04322BK	● FD04336BK	FD20-BAST
BRASS	○	FD16438WH-A	○ FD04322WH	○ FD04336WH	
BRASS	●	FD16438SMG-A	● FD04322SMG	● FD04336SMG	
BRASS	●	FD16438SMP-A	● FD04322SMP	● FD04336SMP	
BRASS	●	FD16438SMN-A	● FD04322SMN	● FD04336SMN	
PLASTIC	●	FD16438-M	FD04322-M		
PLASTIC	○	FD16438-A	FD04322-A		



FD16438BK
Mechanism Black



FD16438SMP-A
Mechanism Soft Matte Patina

ROTARY HANDLE



FD02309BK
Matte Black



FD02309WH
Matte White



FD02309SMG
Satin Matte Gold



FD02309SMP
Soft Matte Patina



FD02309SMN
Satin Matte Nickel

		ONE-WAY 10A 250V	TWO-WAY 10A 250V	INTERMEDIATE 10A 250V	KEYS	FIXING SUPPORT
BRASS	●	FD03110-BK	FD03120-BK	FD03130-BK	● FD02309BK	FD20-BAST
BRASS	○	FD03110-WH	FD03120-WH	FD03130-WH	○ FD02309WH	
BRASS	●	FD03110-SMG	FD03120-SMG	FD03130-SMG	● FD02309SMG	
BRASS	●	FD03110-SMP	FD03120-SMP	FD03130-SMP	● FD02309SMP	
BRASS	●	FD03110-SMN	FD03120-SMN	FD03130-SMN	● FD02309SMN	
PLASTIC	●	FD03110-M	FD03120-M	FD03130-M		
PLASTIC	●	FD03110-A	FD03120-A	FD03130-A		
PLASTIC	○	FD03110	FD03120	FD03130		
		DOUBLE ONE-WAY 10A 250V	ONE WAY 25A 250V	DOUBLE POLE 25A 250V		
BRASS	●	FD03140-BK	FD03150-BK	FD03160-BK		
BRASS	○	FD03140-WH	FD03150-WH	FD03160-WH		
BRASS	●	FD03140-SMG	FD03150-SMG	FD03160-SMG		
BRASS	●	FD03140-SMP	FD03150-SMP	FD03160-SMP		
BRASS	●	FD03140-SMN	FD03150-SMN	FD03160-SMN		
PLASTIC	●	FD03140-M	FD03150-M	FD03160-M		
PLASTIC	●	FD03140-A	FD03150-A	FD03160-A		
PLASTIC	○	FD03140	FD03150	FD03160		

To create your rotary switch, you must choose the frame collection you want, the mechanism code of the colour you want, the key and the mounting bracket code. For example: FD01901SMN + FD03110-SMN + FD02309SMN + FD20-BAST

ROTARY MECHANISMS



FD03110
Unidirectional Rotary Switch | 10A 250V~



FD03120
Rotary bidirectional change | 10A 250V



FD03130
Intermediate rotary switch | 10A 250V~



FD03140
Double Unidirectional SP Switch | 10A 250V~



FD03150
Unidirectional rotary switch | 25A 250V~



FD03160
Double switch rotary | 25A 250V~

COVERS FOR ROTARY SWITCH

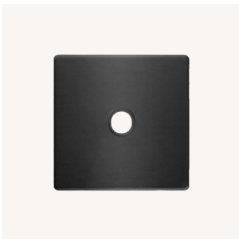

Matte Black



Matte White



Satin Matte Gold

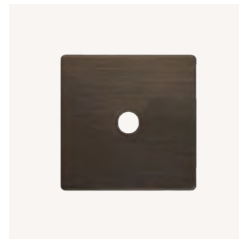

Soft Matte Patina



Satin Matte Nickel

MECHANISM	MECHANISM WITH LED	COLOUR
FD03110	FD03111	-BK ● MATTE BLACK
FD03120	FD03121	-WH ○ MATTE WHITE
FD03130	FD03131	-MG ● SATIN MATTE GOLD
FD03140	FD03141	-SMP ● SOFT MATTE PATINA
FD03150	FD03151	-SMN ● SATIN MATTE NICKEL
FD03160	FD03161	-M ● BLACK PLASTIC
		-A ● BEIGE PLASTIC
		○ WHITE PLASTIC

To create your rotary switch, you must choose the mechanism, and the colour code you want. For example: FD03110 (mechanism) + BK (colour) = FD03110BK

ELECTRONIC DEVICES

TOUCH DIMMER



FD28625-A
Beige



FD28625
White



FD28625-M
Black

Our touch dimmer is a smart and modern device, which significantly expands the ability to control lighting. Compact touch Dimmer for all FEDE frames collections. 230V 50Hz / 600W / 50/60Hz

MECHANISM			FIXING SUPPORT
BLACK PLASTIC	●	FD28625-M	FD20-BAST
BEIGE PLASTIC	●	FD28625-A	
WHITE PLASTIC	○	FD28625	

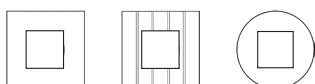

HOTEL CARD MECHANISM

Our new hotel card mechanism offers a refined look thanks to its exclusive brass coating. Exquisite finishes for those lovers of unique details that benefit from the latest technology in LED signaling and a maximum to accept cards of different sizes, ranging from 0.7mm to 1.8mm. It supports all frames of the FEDE collections and is installed in a standard European box (60mm), just as the rest of mechanisms shown in this catalogue.

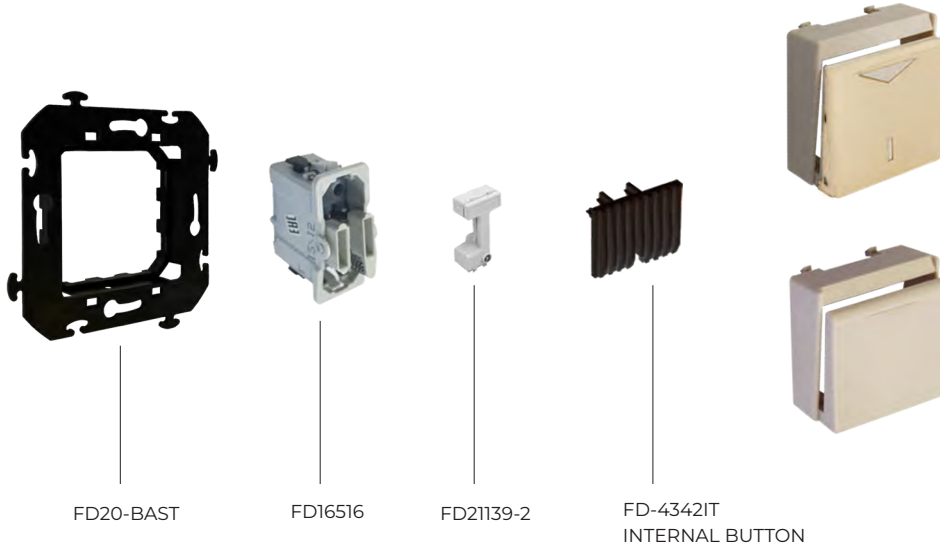

FD20-BAST

FD16516

FD21139-2

FD-4342IT
INTERNAL BUTTON



FD04341SMN
Satin Matte Nickel



FD04341SMN-A
Satin Matte Nickel



FD04341SMP
Soft Matte Patina



FD04341SMP-A
Soft Matte Patina



FD04341SMG
Satin Matte Gold



FD04341SMG-A
Satin Matte Gold



FD04340
White Plastic



FD04340-A
Beige Plastic

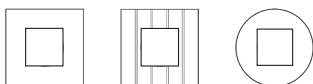

THERMOSTAT WITH METAL COVER

FEDE presents a wide range of electronic devices to provide you with a more comfortable lifestyle. Thermostats for air temperature control, under floor heating and new multi-function thermostat.

For those who prefer original finishes made in brass in perfect combination with our covers, FEDE has developed a new version of our technologically advanced electronic thermostats.

Thermostat for electrical heating floors control 16AA 230V ± 10%, 50/60 Hz. Temperature control range: 5-45°C. Cable 4m with sensor for electrical heating floors included in package

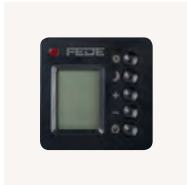

FD18004-M
Black



FD18004
White

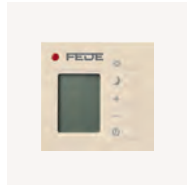

FD18004-A
Beige



FD18004SMG
Satin Matte Gold



FD18004SMP
Soft Matte Patina



FD18004SMN
Satin Matte Nickel

		BLACK MECHANISM	BEIG MECHANISM	WHITE MECHANISM
MATTE BLACK	●	FD18004BK-M	FD18004BK-A	FD18004BK
MATTE WHITE	○	FD18004WH-M	FD18004WH-A	FD18004WH
SATIN MATTE GOLD	●	FD18004SMG-M	FD18004SMG-A	FD18004SMG
SOFT MATTE PATINA	●	FD18004SMP-M	FD18004SMP-A	FD18004SMP
SATIN MATTE NICKEL	●	FD18004SMN-M	FD18004SMN-A	FD18004SMN
BLACK PLASTIC	●	FD18004-M	-	-
BEIG PLASTIC	●	-	FD18004-A	-
WHITE PLASTIC	○	-	-	FD18004

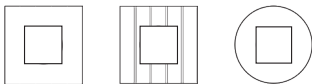

CABLE EXIT MECHANISMS



FD18036BK
Matte Black



FD18036WH
Matte White



FD18036SMG
Soft Matte Gold



FD18036SMP
Satin Matte Patina



FD18036SMN
Satin Matte Nickel

STAIR LIGHT MECHANISMS



FD18037
MECHANISM

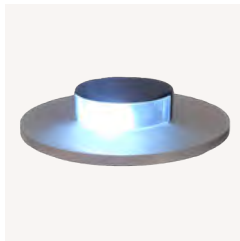

FD18037 MECHANISM +
FRAME

MECHANISM

MATTE BLACK	●	FD18037BK
MATTE WHITE	○	FD18037WH
SATIN MATTE GOLD	●	FD18037SMG
SOFT MATTE PATINA	●	FD18037SMP
SATIN MATTE NICKEL	●	FD18037SMN

POWER SOCKET

For other International Standards, please contact our Sales Staff.



GERMAN SOCKET

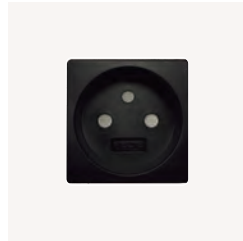

FRENCH SOCKET



BRITISH SOCKET

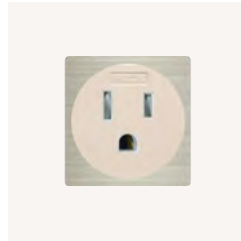

AMERICAN SOCKET

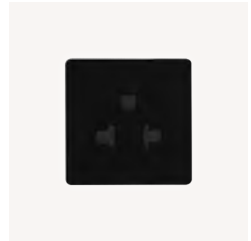

EURO-AMERICAN SOCKET

GERMAN SOCKET

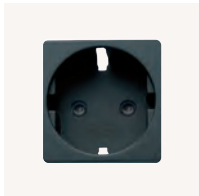

FD16723-M
Black Plastic



FD16723
White Plastic



FD16723-A
Beige Plastic

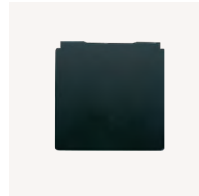

FD16911-M
Black Plastic



FD16911
White Plastic



FD16911-A
Beige Plastic

COVER		FIXING SUPPORT	MECHANISM	FRONT COVER *
PLASTIC	● FD16723-M			
PLASTIC	● FD16723-A	● FD16911-A		
PLASTIC	○ FD16723	○ FD16911		

To create your German socket, you must choose the frame you want, cover code, frame, mechanism and the code of the front cover for square window frame if you wish. For example: FD01901SMP + FD16723-M + FD20-BAST + FD16823.

* Only for use with square window frames

POWER SOCKET

IP44 PROTECTION COVER



FD16823
German Standard
2P+E socket outlet
16A 250V



FD16623
French Standard
2P+E socket outlet
16A 250V



FD16912SMN

The protection cover must be supplied with the frame that is chosen, Being able to combine the finish of the frame and that of the lid if desired.

MATTE BLACK	● FD16912BK
MATTE WHITE	○ FD16912WH
SATIN MATTE GOLD	● FD16912SMG
SOFT MATTE PATINA	● FD16912SMP
SATIN MATTE NICKEL	● FD16912SMN

FRENCH SOCKET

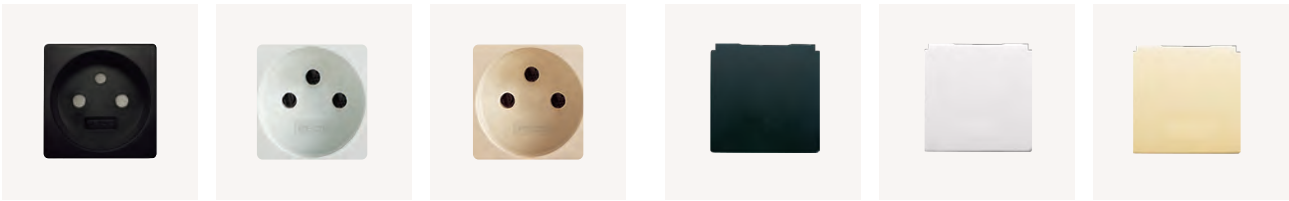

FD16071-M
Black Plastic

FD16071
White Plastic

FD16071-A
Beige Plastic

FD16902-M
Black Plastic

FD16902
White Plastic

FD16902-A
Beige Plastic

COVER		FIXING SUPPORT	MECHANISM	FRONT COVER *
PLASTIC	● FD16071-M	FD20-BAST	FD16623	● FD16902-M
PLASTIC	● FD16071-A			● FD16902-A
PLASTIC	○ FD16071			○ FD16902

To create your French plug, you must choose the frame you want, cover code, frame, mechanism and front cover code if you wish.
For example: FD01901SMP + FD16071-M + FD20-BAST + FD16623 .

* Only for use with square window frames *

BRITISH SOCKET



FD20000SMG-M*
Satin Matte Gold

FD20000SMP-M*
Soft Matte Patina

FD20000SMN-M*
Satin Matte Nickel

FD20000SMG-A*
Satin Matte Gold

FD20000SMP-A*
Soft Matte Patina

FD20000SMN-A*
Satin Matte Nickel



FD20000SMG*
Satin Matte Gold

FD20000SMP*
Soft Matte Patina

FD20000SMN*
Satin Matte Nickel

FD20000-M
Black Plastic

FD20000
White Plastic

FD20000-A
Beige Plastic

○ MECHANISM & COVER	● MECHANISM & COVER	● MECHANISM & COVER	FIXING SUPPORT
BRASS ● FD20000BK	FD20000BK-A	FD20000BK-M	FD22-BAST
BRASS ○ FD20000WH	FD20000WH-A	FD20000WH-M	
BRASS ● FD20000SMG	FD20000SMG-A	FD20000SMG-M	
BRASS ● FD20000SMP	FD20000SMP-A	FD20000SMP-M	
BRASS ● FD20000SMN	FD20000SMN-A	FD20000SMN-M	
PLASTIC FD20000	FD20000-A	FD20000-M	

To create your British socket, you must choose the square window frame you want, cover code, frame and mechanism.

For example: FD02001BK-VC + FD20000BK-A + FD22-BAST.

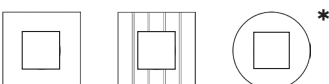

AMERICAN SOCKET

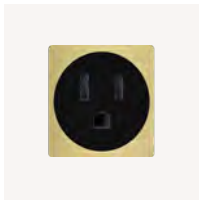

FD22000SMG-M*
Satin Matte Gold

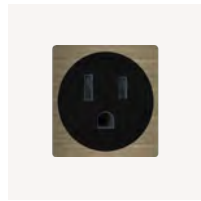

FD22000SMP-M*
Soft Matte Patina

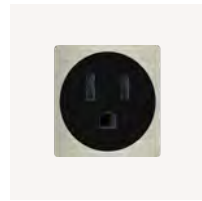

FD22000SMN-M*
Satin Matte Nickel

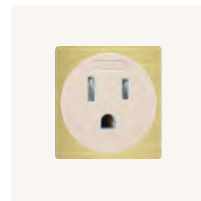

FD22000SMG-A*
Satin Matte Gold

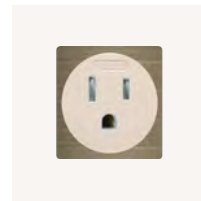

FD22000SMP-A*
Soft Matte Patina

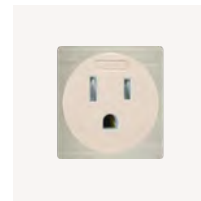

FD22000SMN-A*
Satin Matte Nickel

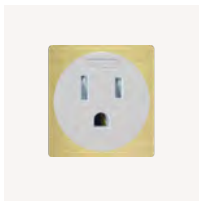

FD22000SMG*
Satin Matte Gold

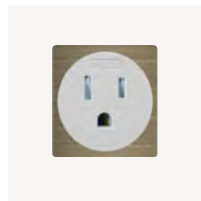

FD22000SMP*
Soft Matte Patina

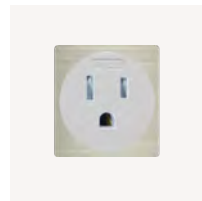

FD22000SMN*
Satin Matte Nickel



FD22000-M
Black Plastic



FD22000
White Plastic



FD22000-A
Beige Plastic

	○ MECHANISM & COVER	● MECHANISM & COVER	● MECHANISM & COVER	FIXING SUPPORT
BRASS	● FD22000BK	● FD22000BK-A	● FD22000BK-M	FD22-BAST
BRASS	○ FD22000WH	○ FD22000WH-A	○ FD22000WH-M	
BRASS	● FD22000SMG	● FD22000SMG-A	● FD22000SMG-M	
BRASS	● FD22000SMP	● FD22000SMP-A	● FD22000SMP-M	
BRASS	● FD22000SMN	● FD22000SMN-A	● FD22000SMN-M	
PLASTIC	FD22000	FD22000-A	FD22000-M	

To create your American socket, you must choose the square window frame you want, the code for the cover, the frame and the mechanism.

For example: FD02001BK-VC + FD22000BK + FD22-BAST.

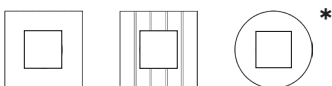

EURO - AMERICAN SOCKET

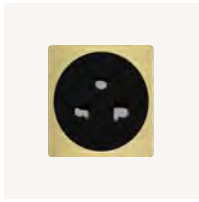

FD21000SMG-M *
Satin Matte Gold

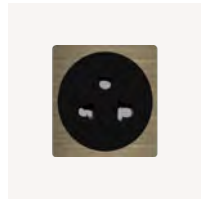

FD21000SMP-M *
Soft Matte Patina

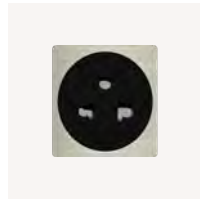

FD21000SMN-M *
Satin Matte Nickel

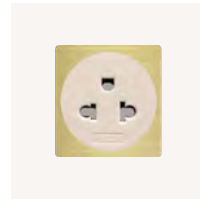

FD21000SMG-A *
Satin Matte Gold

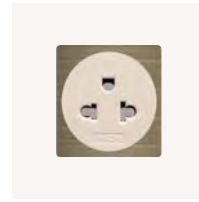

FD21000SMP-A *
Soft Matte Patina

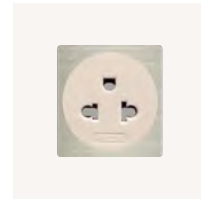

FD21000SMN-A *
Satin Matte Nickel

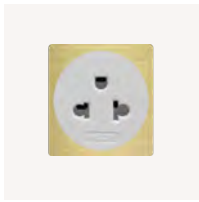

FD21000SMG *
Satin Matte Gold

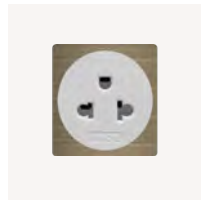

FD21000SMP *
Soft Matte Patina

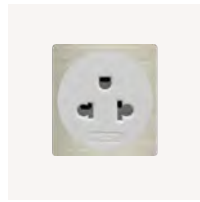

FD21000SMN *
Satin Matte Nickel

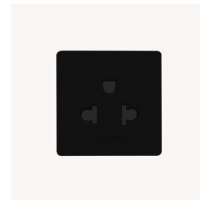

FD21000-M
Black Plastic



FD21000
White Plastic



FD21000-A
Beige Plastic

	○ MECHANISM & COVER	● MECHANISM & COVER	● MECHANISM & COVER	FIXING SUPPORT
BRASS ●	FD21000BK	FD21000BK-A	FD21000BK-M	FD22-BAST
BRASS ○	FD21000WH	FD21000WH-A	FD21000WH-M	
BRASS ●	FD21000SMG	FD21000SMG-A	FD21000SMG-M	
BRASS ●	FD21000SMP	FD21000SMP-A	FD21000SMP-M	
BRASS ●	FD21000SMN	FD21000SMN-A	FD21000SMN-M	
PLASTIC	FD21000	FD21000-A	FD21000-M	

To create your Euro-American socket, you must choose the square window frame you want, the code for the cover, the frame and the mechanism. For example: FD02001BK-VC + FD21000BK + FD22-BAST.

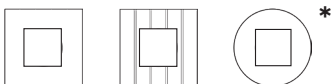

TV / SAT SOCKET OUTLETS

We are offering wide range of professional TV/SAT socket outlets: The compact dimension of the mechanisms ensures fixation of cables and installation to the mounting box in the wall.

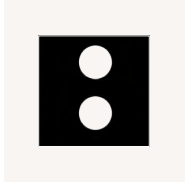

FD4316BK
Matte Black

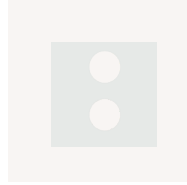

FD4316WH
Matte White

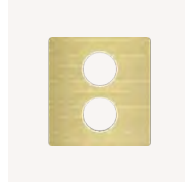

FD4316SMG
Satin Matte Gold

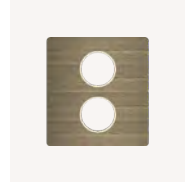

FD4316SMP
Soft Matte Patina

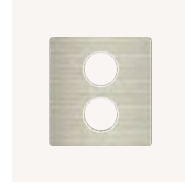

FD4316SMN
Satin Matte Nickel

		COVER SINGLE CONNECTOR	COVER DOUBLE CONNECTOR	FIXING SUPPORT
BRASS	●	FD04315BK-A (beige) FD04315BK-M (black)	FD04316BK-A (beige) FD04316BK-M (black)	FD20-BAST
BRASS	○	FD04315WH-A (beige) FD04315WH-M (black)	FD04316WH-A (beige) FD04316WH-M (black)	
BRASS	●	FD04315SMG-A (beige) FD04315SMG-M (black)	FD04316SMG-A (beige) FD04316SMG-M (black)	
BRASS	●	FD04315SMP-A (beige) FD04315SMP-M (black)	FD04316SMP-A (beige) FD04316SMP-M (black)	
BRASS	●	FD04315SMN-A (beige) FD04315SMN-M (black)	FD04316SMN-A (beige) FD04316SMN-M (black)	
PLASTIC	●	FD04321-M	FD04322-M	
PLASTIC	●	FD04321-A	FD04322-A	
PLASTIC	○	FD04321	FD04322	

- DIECAST BOXES
- SMALL DIMENSIONS
- HIGH EFFICIENCY SHIELD > 90 dB
- ULTRA WIDE BAND WITHIN 4/ 2350 MHZ
- HIGH LINEARITY AND RETURN LOSS IN WHOLE BAND
- SILVERED CONTACTS
- SUITABLE FOR DIGITAL AND ANALOG TV/SAT SIGNALS



Door opening angle greater than 180° in order to facilitate the installation even under difficult conditions.



Features:

- Facilitated entrance of the door screw.
- Curvature designed to tightening different diameters cables in uniform way.

∅ 3,50 mm
∅ 8,00 mm



miniCOMPACT outlet with CONNECTOR F female

miniCOMPACT outlet with IEC male diecast

miniCOMPACT outlet TV/SAT duplexed with F and IEC male connectors

TV / SAT SINGLE SOCKET OUTLETS

	SCHEME	DESCRIPTION	MODEL	TYPICAL USE
FD001F/DC		Terminal IEC PIN RF with DC		TV system DC with a single connectivity RETRO TV
FD002F		Terminal F-OUT RF socket with DC		SAT network with multiswitch 4/8
FD001F		End IEC pin OUT RF isolated		Terminal TV socket for network with a "cascade" connection
FD506F		Passageway IEC pin OUT RF isolate	3dB 6dB 10dB 14dB	TV network DC with a "cascade" connection

TV / SAT SOCKET OUTLETS

	SCHEME	DESCRIPTION	MODEL	TYPICAL USE
FD010F		End OUT SAT with DC OUT TV isolated		TV / SAT networks with a "star" connection
FD011F		End Independent inputs OUT SAT with DC OUT TV isolated		With independent connections of two cables
FD013F		End OUT SAT isolated OUT TV isolated		End TV / SAT socket for network with a "cascade" connection
FD220F		Passageway OUT SAT isolated OUT TV isolated	3dB 6dB 10dB 14dB	TV / SAT network with a "cascade" connection

TV COMPACT SOCKET OUTLETS



FD090F
Aluminum alloy support for fixing connectors



FD091F
F-F connector



FD092F
F-IEC-pin connector

The FD090F support is made of an aluminum alloy with a high shielding ability and, depending on your needs, allows mounting one or two FD091F or FD092F connectors. This kit is installed in the circuit boards. Despite the fact that ecoCOMPACT is the most economical solution, it has a very wide operating range from 4 to 235 MHz and provides compatibility with analog and digital TV / SAT signals.

MULTIMEDIA SOCKETS

FEDE presents a new product line of brass covers for Multimedia sockets. Our new decorative covers provide a luxury finish to Multimedia outlets thanks to their excellent quality.

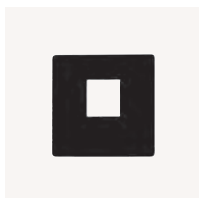

FD4317BK
Matte Black



FD4317WH
Matte White

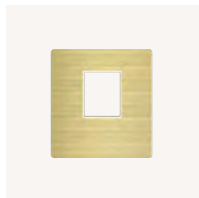

FD4317SMG
Satin Matte Gold

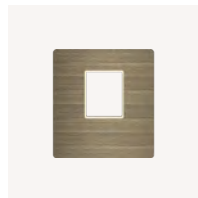

FD4317SMP
Soft Matte Patina



FD4317SMN
Satin Matte Nickel

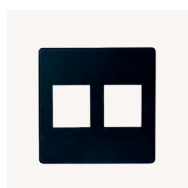

FD4318BK
Matte Black



FD4318WH
Matte White



FD4318SMG
Satin Matte Gold



FD4318SMP
Soft Matte Patina



FD4318SMN
Satin Matte Nickel

COVER SINGLE CONNECTOR		COVER DOUBLE CONNECTOR	FIXING SUPPORT
BRASS	● FD04317BK-A (beige) FD04317BK-M (black)	FD04318BK-A (beige) FD04318BK-M (black)	FD20-BAST
BRASS	○ FD04317WH-A (beige) FD04317WH-M (black)	FD04318WH-A (beige) FD04318WH-M (black)	
BRASS	● FD04317SMG-A (beige) FD04317SMG-M (black)	FD04318SMG-A (beige) FD04318SMG-M (black)	
BRASS	● FD04317SMP-A (beige) FD04317SMP-M (black)	FD04318SMP-A (beige) FD04318SMP-M (black)	
BRASS	● FD04317SMN-A (beige) FD04317SMN-M (black)	FD04318SMN-A (beige) FD04318SMN-M (black)	
PLASTIC	● FD17896-M	FD17897-M	
PLASTIC	● FD17896-A	FD17897-A	
PLASTIC	○ FD17896	FD17897	

ACCESSORIES FOR MULTIMEDIA SOCKETS

When ordering shutters, it is necessary to add the appropriate colour codes: **beige (IV), white (WH), gray (GY), black (BK), red (RD), orange (OR), blue (BL), green (GN), yellow (YL)**



Shutters with designation symbols Package: 50 pcs

- FD-ICON-D-XX** D – DATA (monitor/moniteur / monitor)
- FD-ICON-V-XX** V – VOICE (telephone/téléphone / teléfono)
- FD-ICON-C-XX** C – Cat. 5
- FD-ICON-5e-XX** 5e – Cat. 5e
- FD-ICON-N-XX** N – Without marking
- FD-ICON-6-XX** 6e – Cat. 6

PHONE, COMPUTER & AUDIO CONNECTORS



FD-T6-B | FD-T6-M
Information outlets (internet), Cat. 6e



FD-CORNING
Shielded Silver Toolless
Cat. 6a 10G, 500Mhz.



FD-210HD | FD210HD-M
HDMI connector



**FD710USB
FD710USB-M**
USB type C charger



**FD610USB
FD610USB-M**
USB type A charger



**FD-210USB |
FD-210USB-M**
USB connector Jack-to-jack connection, 2.0A-A, nickel coating.



FD-BJ-B-R
BANANA audio outlet



FD-35S-B
Audio outlet for plugs
Ø3.5mm.



FD-310ST
Self-clamping audio
outlet.



FD-310RSA-YL
RCA connector,
Audio, nickel coating



FD-T3-B | FD-T3-M
6 contacts phone socket
For RJ-11 connector Cat. 3e

FIBER - OPTIC CONNECTORS



FD-1D2/ST
ST connector PB sleeve,
19.20mm

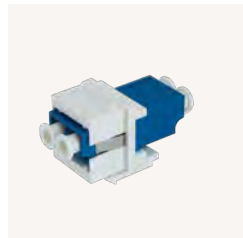

FD-2D2/LC
LC flangeless connector
PB sleeve, 19.20mm



FD-2D2/SC
SC flangeless connector
PB sleeve, 19.20mm
Individual package: 1pc.

INSTALLATION ACCESSORIES



FD2373
71 x 71 x 43 mm

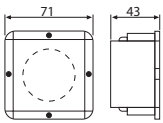

Square installation box for concrete/brick walls.



5625GW
Ø 70 x 45 mm

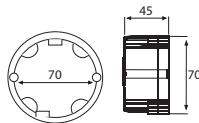

Round installation box for ROUND collection.

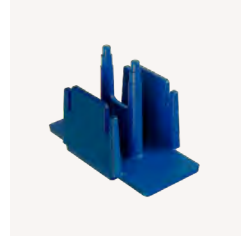

FD5626
Union for mechanism box
FD5625GW

FIXING SUPPORTS



FD20-BAST
For all electrical mechanisms except mechanisms for FD21-BAST



FD21-BAST
For toggle light switch, rotary dimmer and thermostats



FD22-BAST
For type plugs British, American and Euro-American

Each switch plate requires a fixing support to fix the electrical mechanisms into the installation box.

High quality polyamide mounting support with fiberglass.

It contains arrows with the corresponding inscriptions for the correct positioning of the mounting support.

TECHNICAL DATA

CONNECTION DIAGRAMS

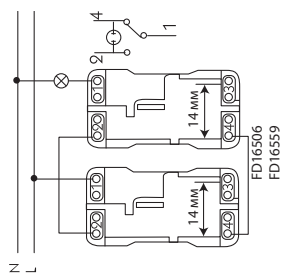

Lamp
FD21139-2 (White)
FD21138-2 (White)

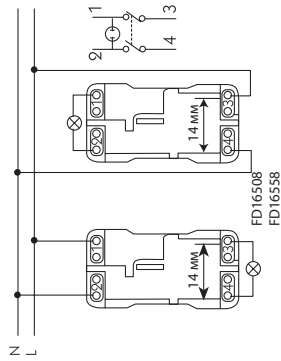

FD16508
FD16558

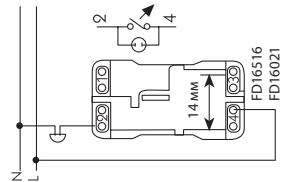

Lamp
FD21139-2 (White)
FD21138-2 (White)

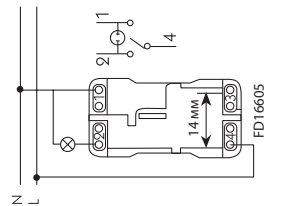

Lamp
FD21139-1 (Blue)
FD21138-1 (Blue)

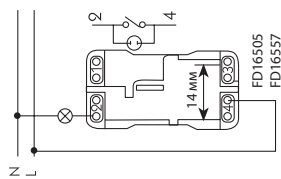

Lamp
FD21139-2 (White)
FD21138-2 (White)

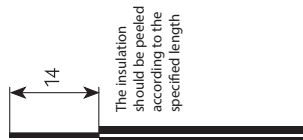

- FD16505 Switch
- FD16506 Switch
- FD16507 Crossover switch
- FD16508 Two-way switch
- FD16516 Push button
- FD16605 Switch with mode indicator
- FD18565 Double push button for blinds
- FD18569 Switch for blinds
- FD16557 Switch 16 A
- FD16558 Two-way switch 16 A
- FD16559 Switch 16 A
- FD16599 Push button with timer switch

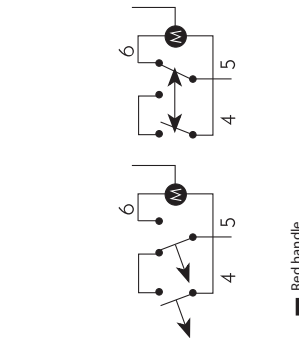

Red handle

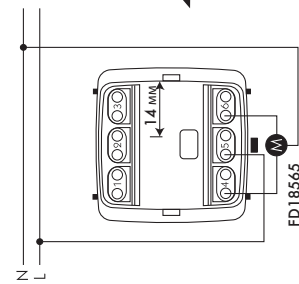

FD18565
FD18569

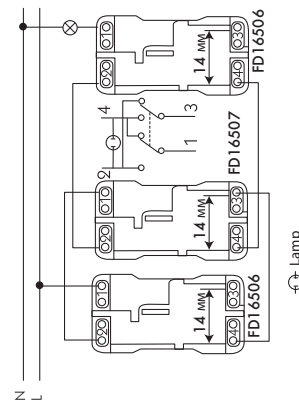

Lamp
FD21139-1 (White)
FD21138-1 (White)

TECHNICAL DATA

CONNECTION DIAGRAMS

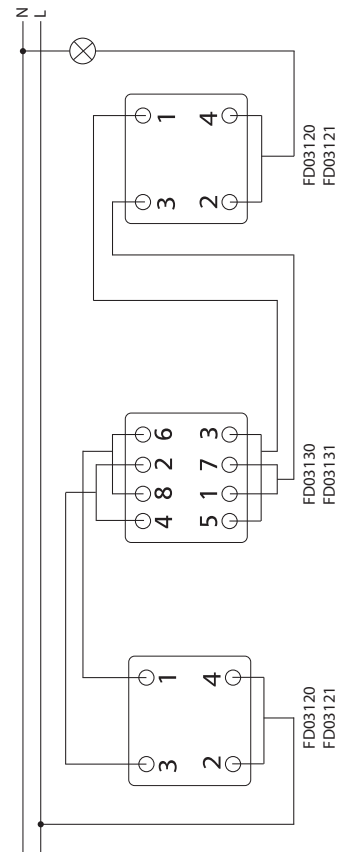
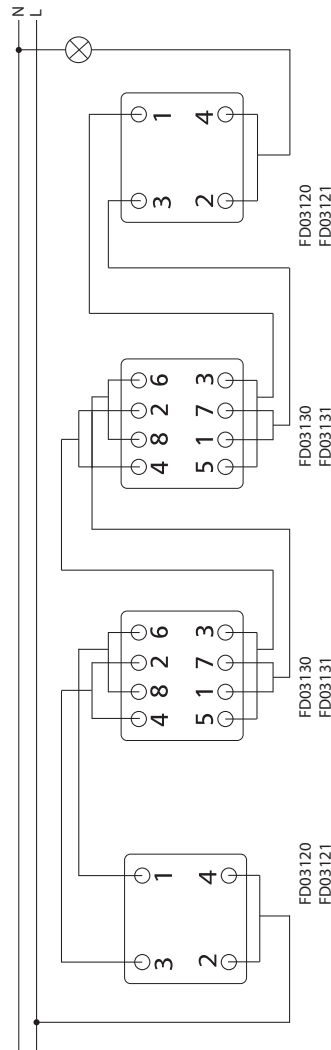
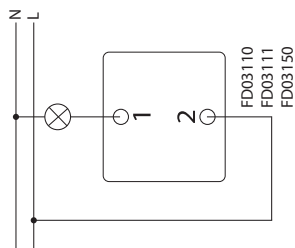
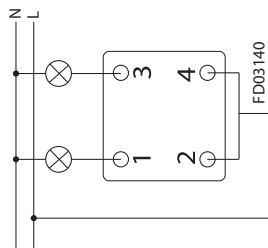
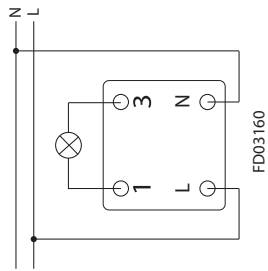
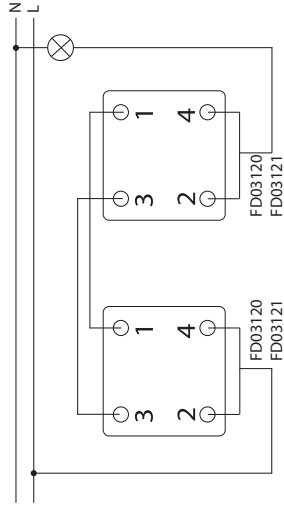

- FD03110 / FD03111 One-way rotary switch 10 A / One-way rotary switch 10 A for LED
- FD03120 / FD03121 Two-way rotary switch / Two-way rotary switch for LED
- FD03130 / FD03131 Intermediate rotary switch / Intermediate rotary switch for LED
- FD03140 Double one-way SP switch
- FD03150 One-way rotary switch 25
- FD03160 Double pole rotary switch 25 A

TECHNICAL DATA

CONNECTION DIAGRAMS

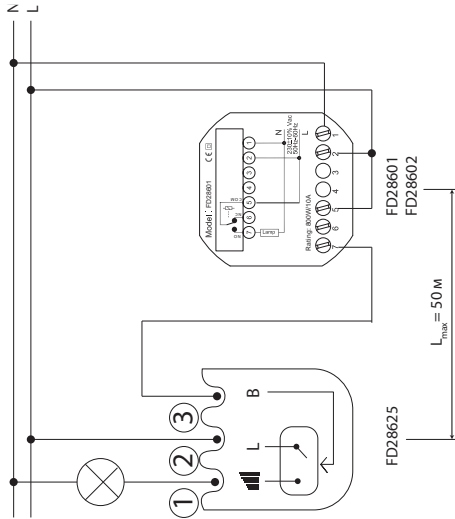

- FD16505 One-way SP switch
- FD16506 Two-way SP switch
- FD16438 Rotary dimmer
- FD28601 Individual-light switch
- FD28602 Double-key light switch
- FD28625 Compact touch dimmer for all FEDE frames collections

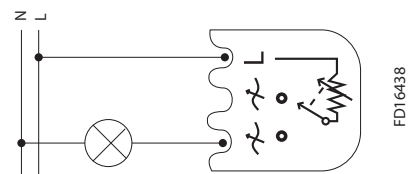
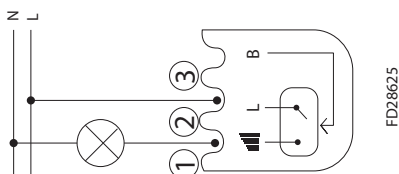
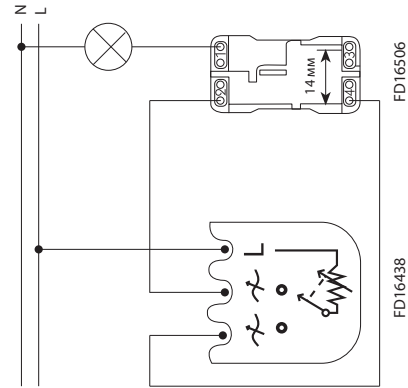
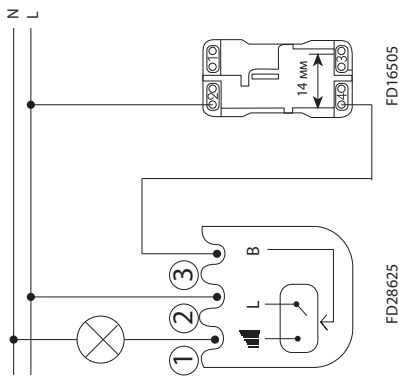

TECHNICAL DATA

CONNECTION DIAGRAMS

To control the light regulators use the mechanisms of the push buttons FD16516 without LED.

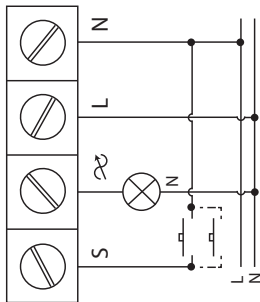

Load connection:
To reduce the level of electromagnetic interference, use a parallel connection of the load circuit.

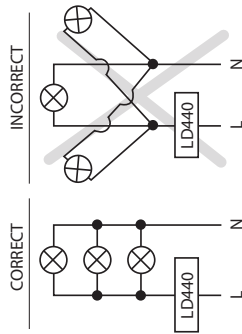

- LD220 Dimmer for push button installation
- LD440 Dimmer for push button installation
- LD220WCM Dimmer for push button installation
- LD220KRON Dimmer for push button installation

TABLE FOR SELECTION OF DIMMERS

Code	Dimmer type	For incandescent and halogen lamps		For dimmable CFLs and LEDs with E14, E27 and GU10 base		For dimmable electronic transformers and LED drivers	
		Icon	Power (W)	Icon	Power (W)	Icon	Power (W)
FD16438	Rotary		750 W		No		No
FD28625	Touch		600 W		No		No
LD220	To install with push button		200 W		200 W		200 W
LD440	To install with push button		440 W		440 W		440 W
LD220WCM	To install with push button		200 W		200 W		200 W
LD220KRON	To install with push button		2x100 W		2x100 W		2x100 W

TECHNICAL DATA

CONNECTION DIAGRAMS

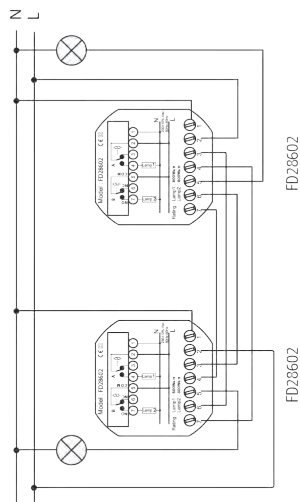

FD28602

FD28602

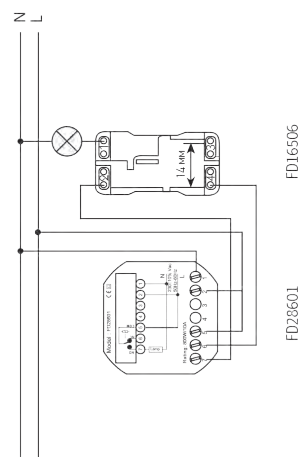

FD16506

FD28601

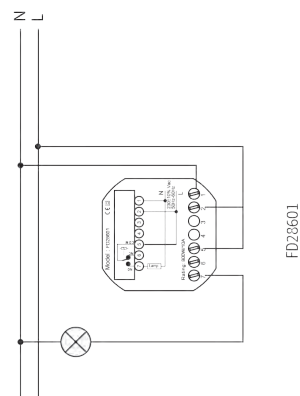

FD28601

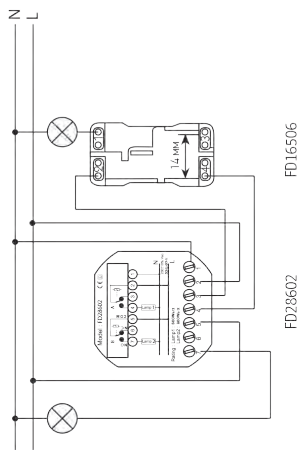

FD16506

FD28602

Using 2 channels

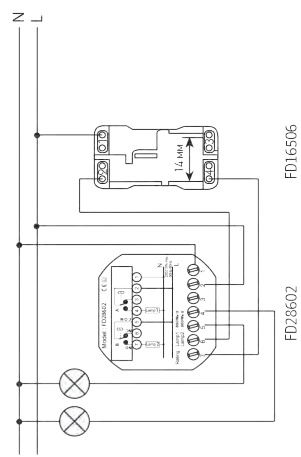

FD16506

FD28602

Using 1 channel

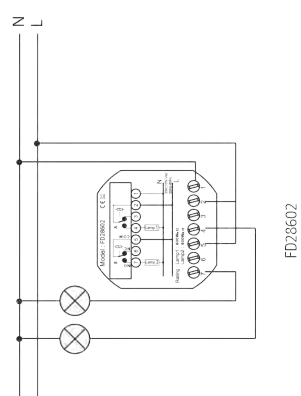

FD28602

- FD28601** Individual-light switch
- FD28602** Double-key-light switch
- FD16506** Two-way SP switch

TECHNICAL DATA

CONNECTION DIAGRAMS

Thermostats FD18000/FD18001

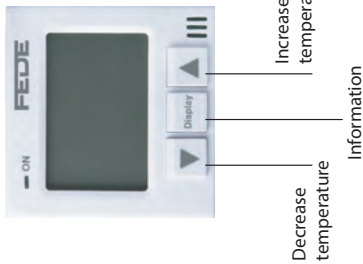

This thermostat provides simple and intuitive temperature management, whose current settings are displayed on a large LCD. Thanks to the built-in RGB, the thermostat display changes colour according to the operating mode: when the heating mode is activated, the display will light blue. The set temperature and the actual temperature are shown alternately on the display; pressing the "DISPLAY" button will only display the actual temperature, and pressing the button again will re-activate the information collation mode.

There are two versions of thermostat available:
 FD18000 — to control the floor temperature.
 FD18001 — to control the room air temperature.

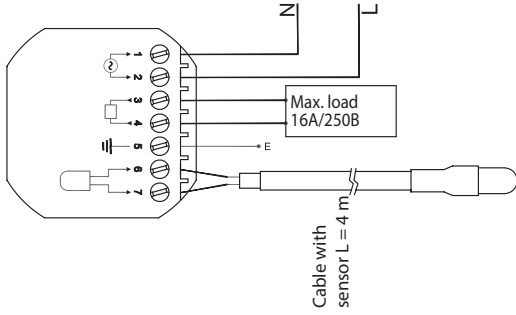

Multifunctional thermostat FD18004

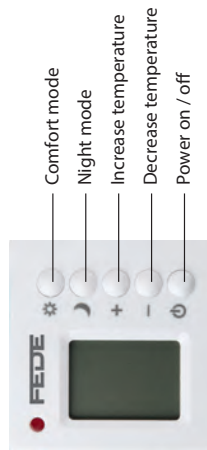

This thermostat allows the previous programming of two modes of operation: economic and comfort. The modes are selected by clicking on corresponding buttons. The LCD displays the current thermostat setting.

- This thermostat can operate in the following modes:
- floor temperature control.
 - air temperature control.
 (for example, when connecting electric radiators)
 - combined mode

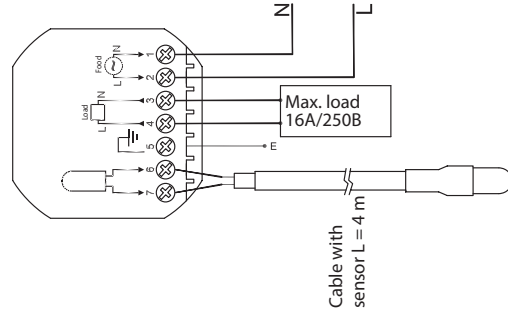

TECHNICAL DATA

CONNECTION DIAGRAMS

There are two types of television signal wiring for several users: the parallel circuit ("star" wiring) and the series circuit. In the first case the dividers, also called separators, are used, which are responsible for equitably dividing the power of the input signal into 2, 3 and 4; although it should be noted that for each division in 2 the power of the signal for each output also decreases by half (actually even a little more: the signal drop is usually 3.5-4.5 dB). This method of wiring provides a great uniformity of power in the television frequency band and a great insulation between the terminals, however, it requires more cables.

In the second case the couplers are used and the television channels are connected in series (cascade) one after another. This type of wiring offers unequal division of the signal. Such a wiring method provides uneven division of the signal, is easier to implement and requires fewer cables. However, when this scheme is implemented the signal reaches a lower number of TV receivers.

- TV signal
- SAT signal
- TV & SAT signal

EXAMPLE OF USING THE FD220F PLUG BASE TO CREATE A "WATERFALL" TV / SATELLITE NETWORK WITH AN I-F CABLE

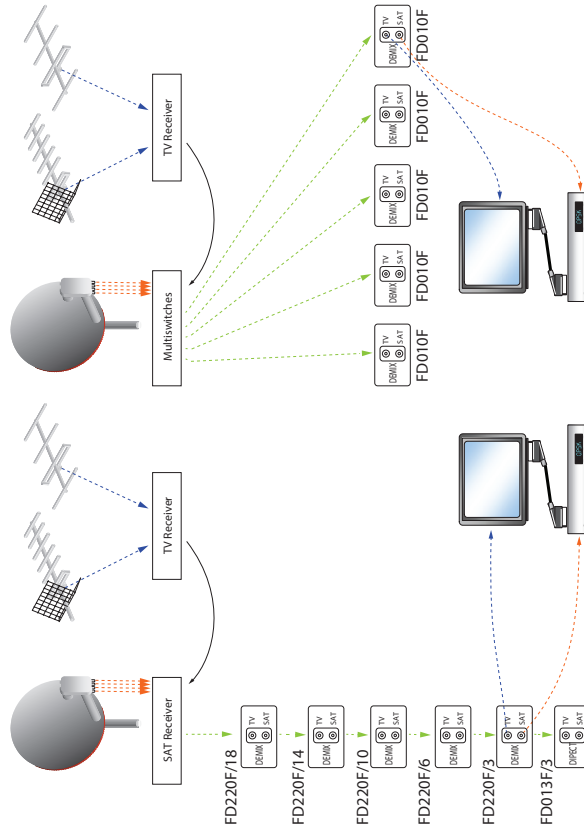

EXAMPLE OF USE OF FD010F PLUG BASES TO CREATE A "STAR" TYPE TV / SATELLITE NETWORK

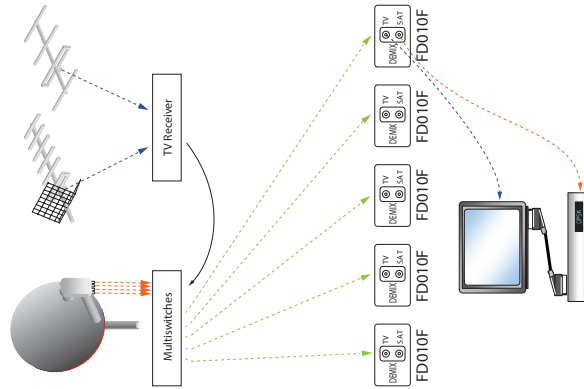

EXAMPLE OF USE FD011F SOCKET OR "ECOCOMPACT" KIT TO CREATE THE TV / SATELLITE NETWORK

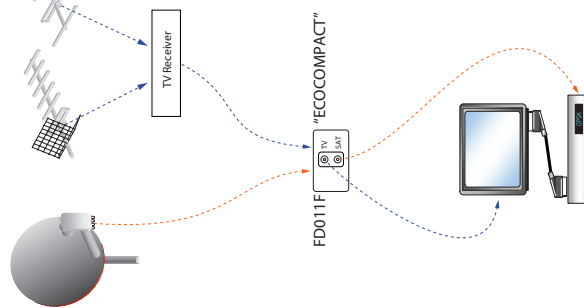

EXAMPLE OF USE FD506F AND FD002F SOCKETS TO ESTABLISH A "WATERFALL" TV NETWORK AND THE DIRECT CONNECTION OF TV SATELLITE

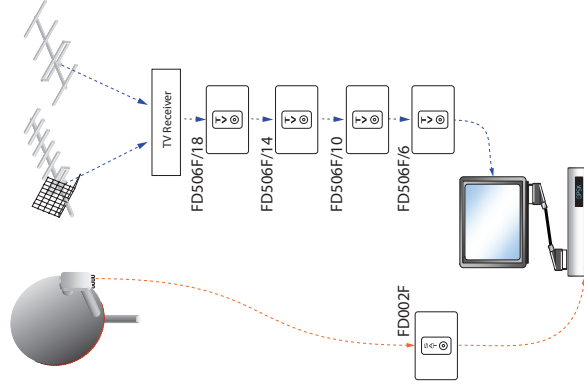

TECHNICAL DATA

ROUND COLLECTION

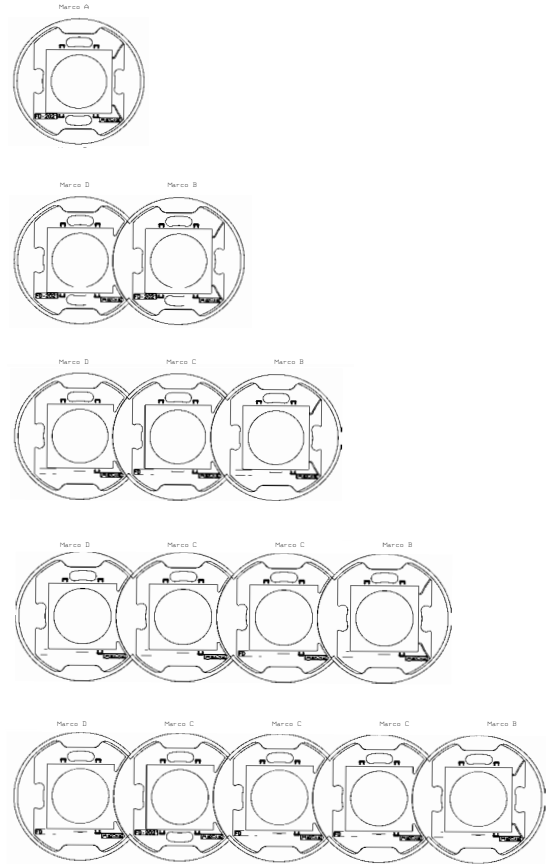
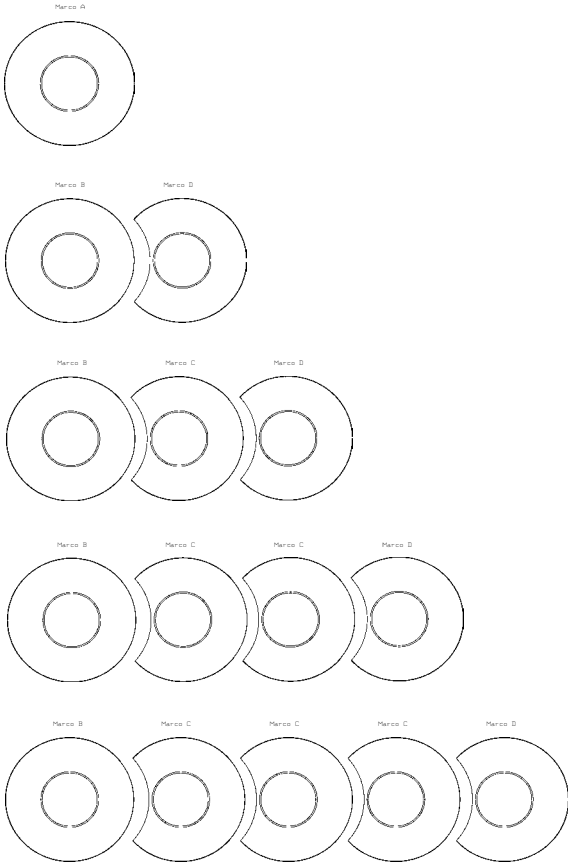

download catalogue



<https://fedeswitchandlight.com/catalogues/>



follow us



@fedebcn.official



[linkedin.com/company/fede](https://www.linkedin.com/company/fede)



@fedebcnofficial



@fedeswitchandlight



HEADQUARTERS & SHOWROOM

Av. Llenguadoc, 47 · 08915 Badalona (Barcelona) SPAIN
Phone +34 934 183 856 · WhatsApp +34 656 382 326
info@fedeswitchandlight.com · www.fedeswitchandlight.com

C2023#001

FEDE
SWITCH & LIGHT