



EGLO

my light | my style



TREND & STYLE

COLLECTION

2022/23



TREND & STYLE COLLECTION

Dear reader,

Vintage, the enduringly popular interior design style, has adorned the homes of our customers for several years now and continues to exhibit stunning versatility, reflecting the charm of past decades. We have taken inspiration from this style in our luminaire designs, allowing our customers to add a little extra character to their homes with some of our lighting fixtures.

Interior design trends are as rich and diverse as life itself, and new trends are discovered and reinterpreted every year. New trends and styles are constantly being created by combining and recombining different materials and designs. Our own catalogue seeks to showcase this near-limitless range of ideas and options.

Liebe Leserin, lieber Leser,

der bis heute so beliebte Einrichtungsstil Vintage verschönert das Heim unserer Kunden schon seit mehreren Jahren und versprüht durch seine Vielfältigkeit den Charme aus verschiedenen Jahrzehnten. Von diesem Flair haben wir uns bei unseren Leuchten Designs gerne inspirieren lassen und unseren Kunden so ermöglicht, mit ihrer Beleuchtung Persönlichkeit in die eigenen 4-Wände zu bringen.

Einrichtungstrends sind so facettenreich wie das Leben selbst und werden Jahr für Jahr neu entdeckt und -interpretiert. Durch die Kombinationen von unterschiedlichen Materialien und Designs werden immer neue Trends und Stile geschaffen. Diese nahezu grenzenlosen Ideen und Möglichkeiten haben uns dazu veranlasst, den Trend-Welten mit unserem Katalog die passende Bühne zu bieten.

Chère lectrice, cher lecteur,

Très en vogue, le style vintage embellit l'intérieur de nos clients depuis de nombreuses années déjà et, grâce à sa grande diversité, diffuse le charme de différentes décennies. Nous avons souhaité nous inspirer de cet esprit pour le design de nos luminaires et ainsi permettre à nos clients de refléter leur propre personnalité dans leur foyer à l'aide d'éléments d'éclairage bien choisis.

Les tendances en matière d'aménagement sont aussi diversifiées que la vie elle-même, et chaque année apporte son lot de nouvelles découvertes et de réinterprétations. L'association de différents matériaux et designs donne constamment naissance à de nouvelles tendances et à de nouveaux styles. Cette abondance d'idées et de possibilités nous a incités à mettre en avant les différents univers de tendances dans notre catalogue.

EDITORIAL

Our Trend & Style collection features the latest trends for the 2022/23 season.

Our luminaire portfolio has been expanded to include exciting compositions made from natural materials, metal and glass. Metal wrapped in hemp yarn and bamboo frames covered in fabric are just two of the highlights of our new luminaire designs.

In der Trend & Style Kollektion erwarten Sie die aktuellen Trend-Welten der Saison 2022/23.

Unser Leuchten Portfolio wurde um spannende Kompositionen aus Naturmaterialien, Metall und Glas ergänzt. Mit Hanfgarn umwickeltes Metall und mit Textil umspannte Bambusrahmen sind die Highlights unserer neuen Leuchten-Designs.

Dans la collection Trend & Style, vous trouverez toutes les tendances actuelles de la saison 2022/23.

Notre gamme de luminaires est complétée de splendides compositions mêlant matériaux naturels, métal et verre. Le métal enveloppé dans du fil de chanvre et les cadres en bambou associés à des matières textiles sont les éléments phares de nos nouveaux designs de luminaires.

INDUSTRIAL

P.04



LOFT

P.76



VINTAGE

P.194



NATURE

P.216



COTTAGE CHIC

P.240



ETHNO ELEGANCE

P.254



SOCKETS

P.266

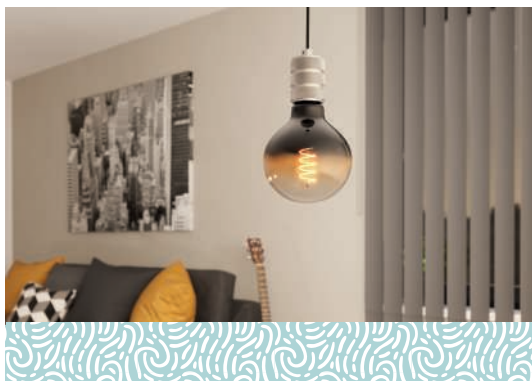

ILLUMINANTS

P.272







































INDUSTRIAL

Soft lines, playful curves and comfort? Certainly not. The industrial range is dominated by hard and functional elements. Raw metal parts are turned into luminaires and spread the rough style of factory halls. The Industrial Look celebrates the aesthetic of things imperfect.

Weiche Linien, verspielte Rundungen und Gemütlichkeit? Mitnichten. Im Industrial-Sortiment dominieren harte und funktionelle Elemente. Rohe Metallteile werden zu Leuchten verarbeitet und verbreiten den groben Stil von Fabrikhallen. Der Industrial Look zelebriert die Ästhetik des Imperfekten.

Des lignes tendres, des arrondis enjoués et de la convivialité ? En aucun cas. Des éléments durs et fonctionnels dominent la gamme industrielle. Des pièces métalliques brutes sont usinées pour devenir des luminaires et diffusent le style franc d'usines. Le look industriel symbolise l'esthétique de l'imperfection.



MILLIGAN p. 6-9	JUBILY p. 10-11	DELOW p. 12-13	MANBY p. 14-15	REDCLIFFE p. 16-17	CATTERICK p. 18-19	IKESTON p. 20-21	SPEKE p. 22
							
SEDBERGH p. 23	BRICKFIELD p. 24	FORESTBURG p. 25	HILCOTT p. 26-27	TURROCK p. 28-29	TAKELEY p. 30	BARNSTAPLE 1 p. 32-33	SHIREBROOK p. 33
							
BARNSTAPLE p. 34-37	LUBENHAM 1 p. 38	LUBENHAM p. 38-39	WINKWORTH 1 p. 40	EBURY p. 41	TRURO 1 p. 42	TRURO 2 p. 42, 44	ROCKINGHAM p. 42
							
GRANTHAM 1 p. 43	AUCKLAND p. 44	TRURO p. 44	PRIDDY 1 p. 45	PRIDDY p. 46-48	TREBURLEY p. 50	COVALEDA 1 p. 50	COVALEDA p. 53
							
EMBLETON p. 54	MARDYKE p. 56-57	LONGINO p. 58	CHARTERHOUSE p. 59	ELSWICK p. 60	FEMBARD p. 60	WILMCOTE p. 61	EXMOOR p. 61
							
OLDBURY p. 62	PORT SETON p. 63	TOWNSHEND 4 p. 63-65	PRESTWICK 2 p. 66-67	PRESTWICK 1 p. 67	GATEBECK p. 68-69	LAYHAM p. 70-71	HARBOROUGH p. 72
							
EVESHAM p. 72-73	KILNSDALE p. 74						
							



This product is available in different colors and shapes./ Dieser Artikel ist in unterschiedlichen Farben und Formen verfügbar.
Cet article est disponible en différentes couleurs et formes.



43625 MILLIGAN

pendant light; steel, black, white
 Hängeleuchte; Stahl, schwarz, weiss
 luminaire en suspension; acier, noir, blanc

H 1100, Ø 200



9 002759 436254



43626 MILLIGAN

pendant light; steel, black, white
 Hängeleuchte; Stahl, schwarz, weiss
 luminaire en suspension; acier, noir, blanc

L 1030, B 200, H 1100



9 002759 436261

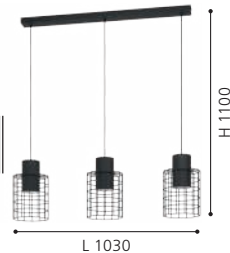

43628 MILLIGAN

pendant light; steel, black, white
 Hängeleuchte; Stahl, schwarz, weiss
 luminaire en suspension; acier, noir, blanc

H 1100, Ø 480



9 002759 436285

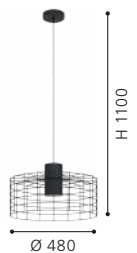



43627

43627 MILLIGAN

pendant light; steel, black, white
Hängeleuchte; Stahl, schwarz, weiss
luminaire en suspension; acier, noir, blanc

H 1100, Ø 380



E27



1x 40W



9 002759 436278



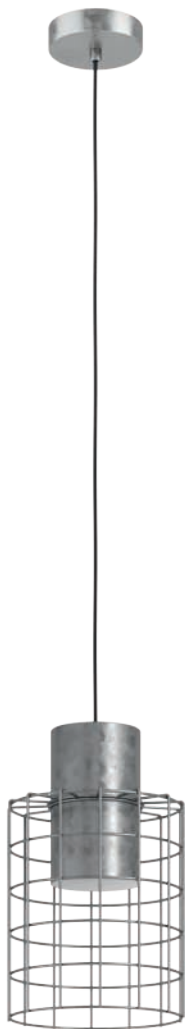

43647



43648

43647 MILLIGAN

pendant light; steel, zinc-plated, white
 Hängeleuchte; Stahl, verzinkt, weiss
 luminaire en suspension; acier, galvanisé, blanc

H 1100, Ø 200



E27 1x 40W



9 002759 436476

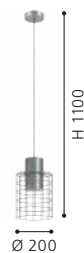

43648 MILLIGAN

pendant light; steel, zinc-plated, white
 Hängeleuchte; Stahl, verzinkt, weiss
 luminaire en suspension; acier, galvanisé, blanc

L 930, B 200, H 1100



E27 3x 40W



9 002759 436483

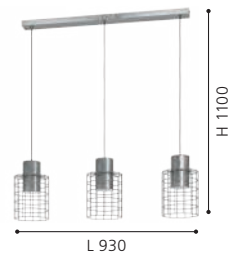

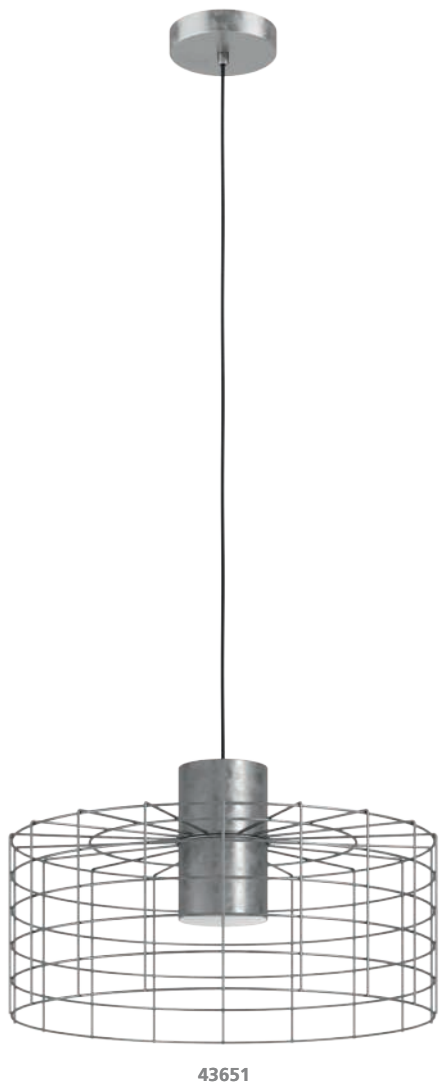

43651



43649

43651 MILLIGAN

pendant light; steel, zinc-plated, white
 Hängeleuchte; Stahl, verzinkt, weiss
 luminaire en suspension; acier, galvanisé, blanc

H 1100, Ø 480



E27



1x 40W



9 002759 436513

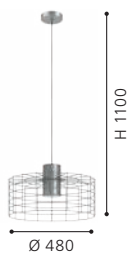

43649 MILLIGAN

pendant light; steel, zinc-plated, white
 Hängeleuchte; Stahl, verzinkt, weiss
 luminaire en suspension; acier, galvanisé, blanc

H 1100, Ø 380



E27



1x 40W



9 002759 436490

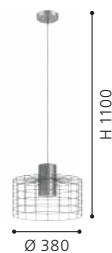

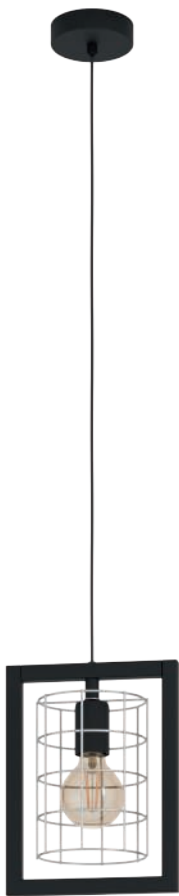

43662



43663



43664

43662 JUBILY

pendant light; steel, black / steel, zinc-plated
 Hängeleuchte; Stahl, schwarz / Stahl, verzinkt
 luminaire en suspension; acier, noir / acier, galvanisé

L 220, B 145, H 1100



E27 1x 40W



9 002759 436629



43663 JUBILY

pendant light; steel, black / steel, zinc-plated
 Hängeleuchte; Stahl, schwarz / Stahl, verzinkt
 luminaire en suspension; acier, noir / acier, galvanisé

L 770, B 145, H 1100



E27 3x 40W



9 002759 436636

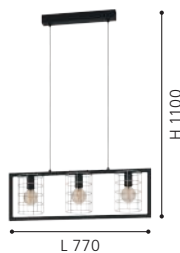

43664 JUBILY

wall light; steel, black / steel, zinc-plated
 Wandleuchte; Stahl, schwarz / Stahl, verzinkt
 applique; acier, noir / acier, galvanisé

L 220, H 290, A 195



E27 1x 40W



9 002759 436643





43661



43665

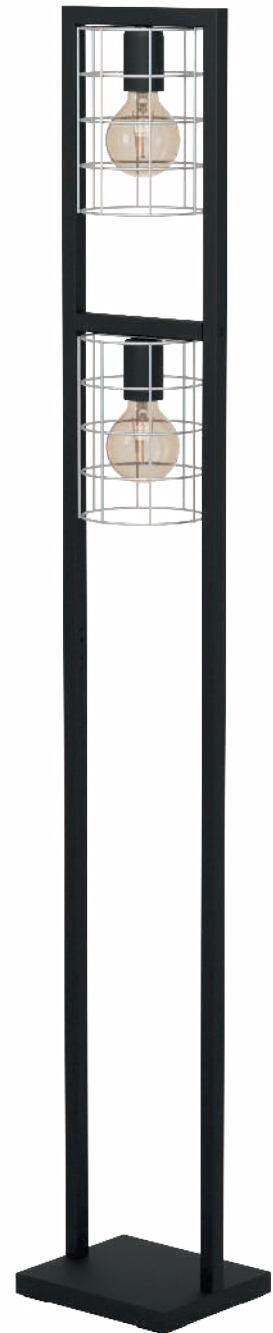

43666

43661 JUBILY

ceiling light; steel, black / steel, zinc-plated
Deckenleuchte; Stahl, schwarz / Stahl, verzinkt
plafonnier; acier, noir / acier, galvanisé

L 770, B 190, H 255



E27 3x 40W



9 002759 436612



43665 JUBILY

table light; steel, black / steel, zinc-plated
Tischleuchte; Stahl, schwarz / Stahl, verzinkt
luminaire de table; acier, noir / acier, galvanisé

L 220, B 145, H 535, Base: B 220, T 150



E27 1x 40W



9 002759 436650



43666 JUBILY

floor light; steel, black / steel, zinc-plated
Stehleuchte; Stahl, schwarz / Stahl, verzinkt
lampadaire; acier, noir / acier, galvanisé

L 220, B 145, H 1455, Base: B 220, T 190



E27 2x 40W



9 002759 436667





43605



43603



43604

43605 DELLOW

pendant light; steel, black / steel, black, brass
 Hängeleuchte; Stahl, schwarz / Stahl, schwarz, messing
 luminaire en suspension; acier, noir / acier, noir, laiton

L 880, B 180, H 1100



E27 3x 40W



9 002759 436056



43604 DELLOW

pendant light; steel, black / steel, black, brass
 Hängeleuchte; Stahl, schwarz / Stahl, schwarz, messing
 luminaire en suspension; acier, noir / acier, noir, laiton

H 1100, Ø 450



E27 1x 40W



9 002759 436049



43603 DELLOW

ceiling light; steel, black / steel, black, brass
 Deckenleuchte; Stahl, schwarz / Stahl, schwarz, messing
 plafonnier; acier, noir / acier, noir, laiton

H 270, Ø 450



E27 1x 40W



9 002759 436032





43533



43532



43531

43533 DELLOW

spot; steel, black / steel, black, brass
Spot; Stahl, schwarz / Stahl, schwarz, messing
spot; acier, noir / acier, noir, laiton

L 830, B 180, H 210



E27



3x 40W



9 002759 435332



L 830

H 210

43532 DELLOW

spot; steel, black / steel, black, brass
Spot; Stahl, schwarz / Stahl, schwarz, messing
spot; acier, noir / acier, noir, laiton

L 475, B 180, H 210



E27



2x 40W



9 002759 435325



L 475

H 210

43531 DELLOW

spot; steel, black / steel, black, brass
Spot; Stahl, schwarz / Stahl, schwarz, messing
spot; acier, noir / acier, noir, laiton

L 180, B 110, H 200



E27



1x 40W



9 002759 435318

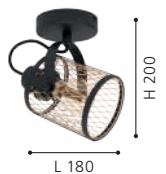

L 180

H 200



43796

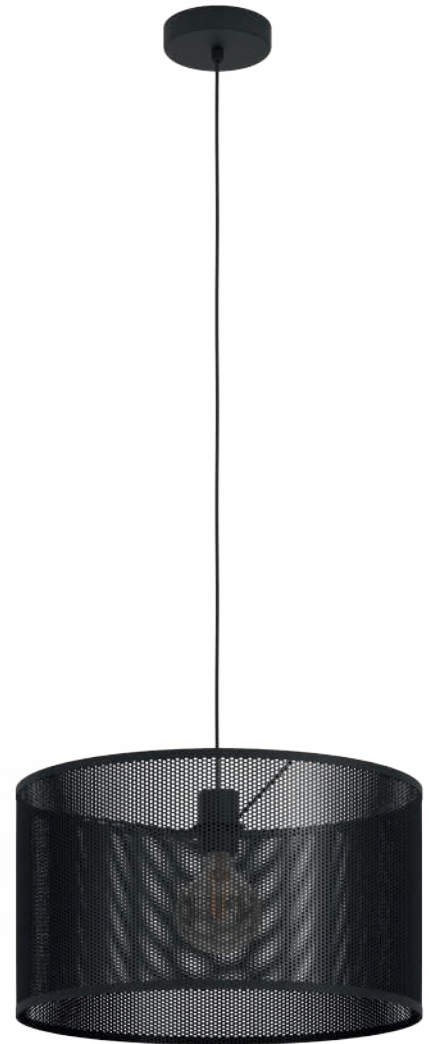

43795

43796 MANBY

pendant light; steel, black
 Hängeleuchte; Stahl, schwarz
 luminaire en suspension; acier, noir

L 900, B 200, H 1100



E27



3x 40W



9 002759 437961



43795 MANBY

pendant light; steel, black
 Hängeleuchte; Stahl, schwarz
 luminaire en suspension; acier, noir

H 1100, Ø 450



E27



1x 40W



9 002759 437954

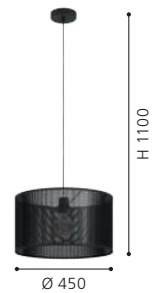



43794

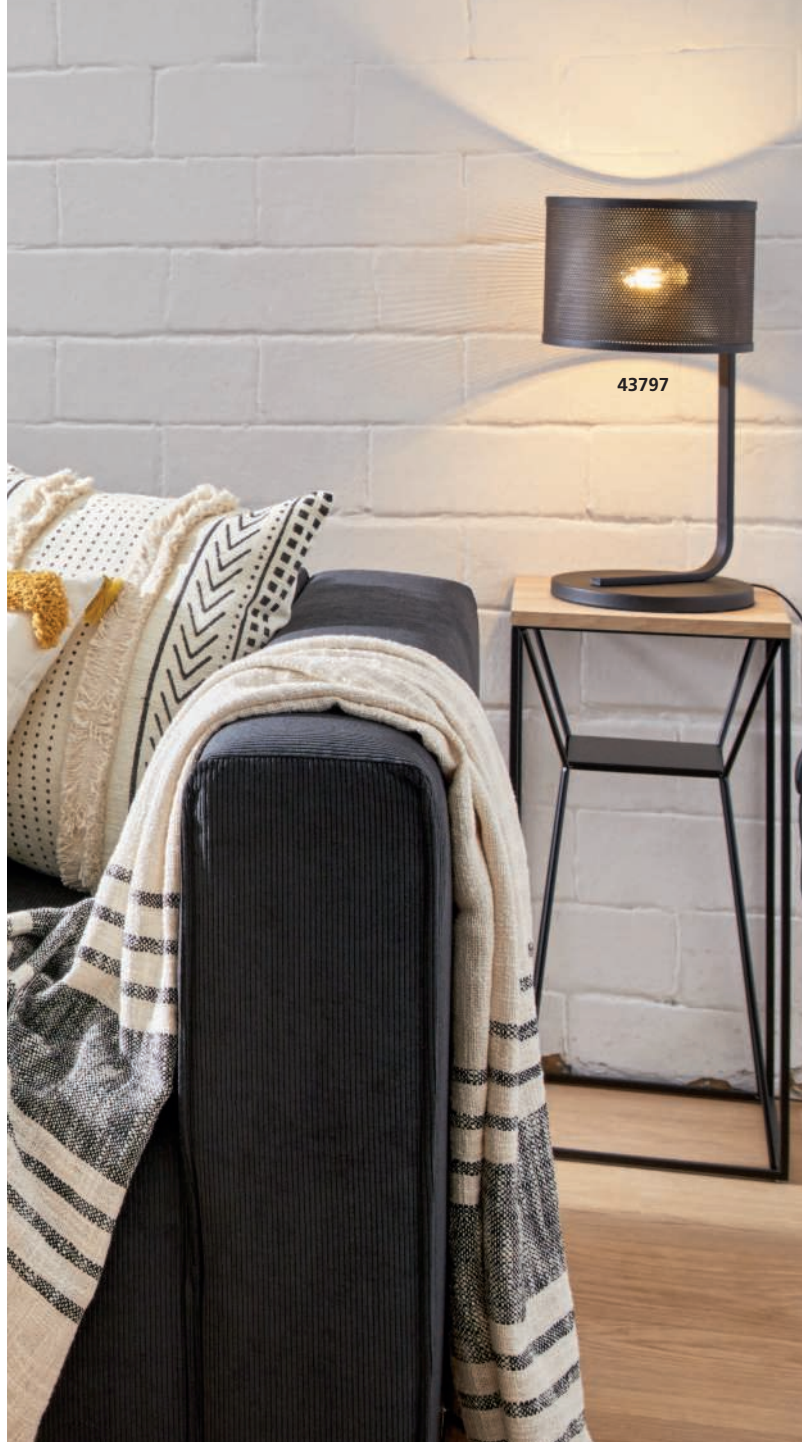

43797

43794 MANBY

ceiling light; steel, black
Deckenleuchte; Stahl, schwarz
plafonnier; acier, noir

H 280, Ø 450



E27



1x 40W



9 002759 437947

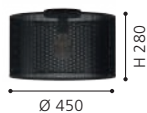

43797 MANBY

table light; steel, black
Tischleuchte; Stahl, schwarz
luminaire de table; acier, noir

H 485, Ø 240, Base: Ø 230



E27



1x 40W



9 002759 437978





DETAIL 43534

To replace the bulbs, the lamp can be taken apart in the middle.
Zum Tausch der Leuchtmittel können die beiden Hälften der Leuchte in der Mitte auseinander genommen werden.
Pour remplacer les ampoules, la luminaire peut être démontée au milieu.



43534 REDCLIFFE

pendant light; steel, black
Hängeleuchte; Stahl, schwarz
luminaire en suspension; acier, noir

L 1080, B 125, H 1100



E27



4x 40W



9 002759 435349

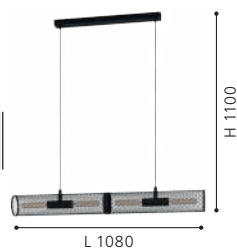

43535 REDCLIFFE

wall / ceiling light; steel, black
Wand- / Deckenleuchte; Stahl, schwarz
applique / plafonnier; acier, noir

L 540, B 120, H 145



E27



2x 40W



9 002759 435356

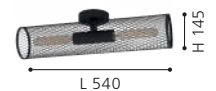



43538



43536



43537

43538 REDCLIFFE

wall light; steel, black
Wandleuchte; Stahl, schwarz
applique; acier, noir

L 120, H 280, A 145



E27



1x 40W



9 002759 435387



43536 REDCLIFFE

table light; steel, black
Tischleuchte; Stahl, schwarz
luminaire de table; acier, noir

H 380, Ø 120, Base: Ø 120



E27



1x 40W



9 002759 435363



43537 REDCLIFFE

floor light; steel, black
Stehleuchte; Stahl, schwarz
lampadaire; acier, noir

H 1355, Ø 120, Base: Ø 250



E27



4x 40W



9 002759 435370



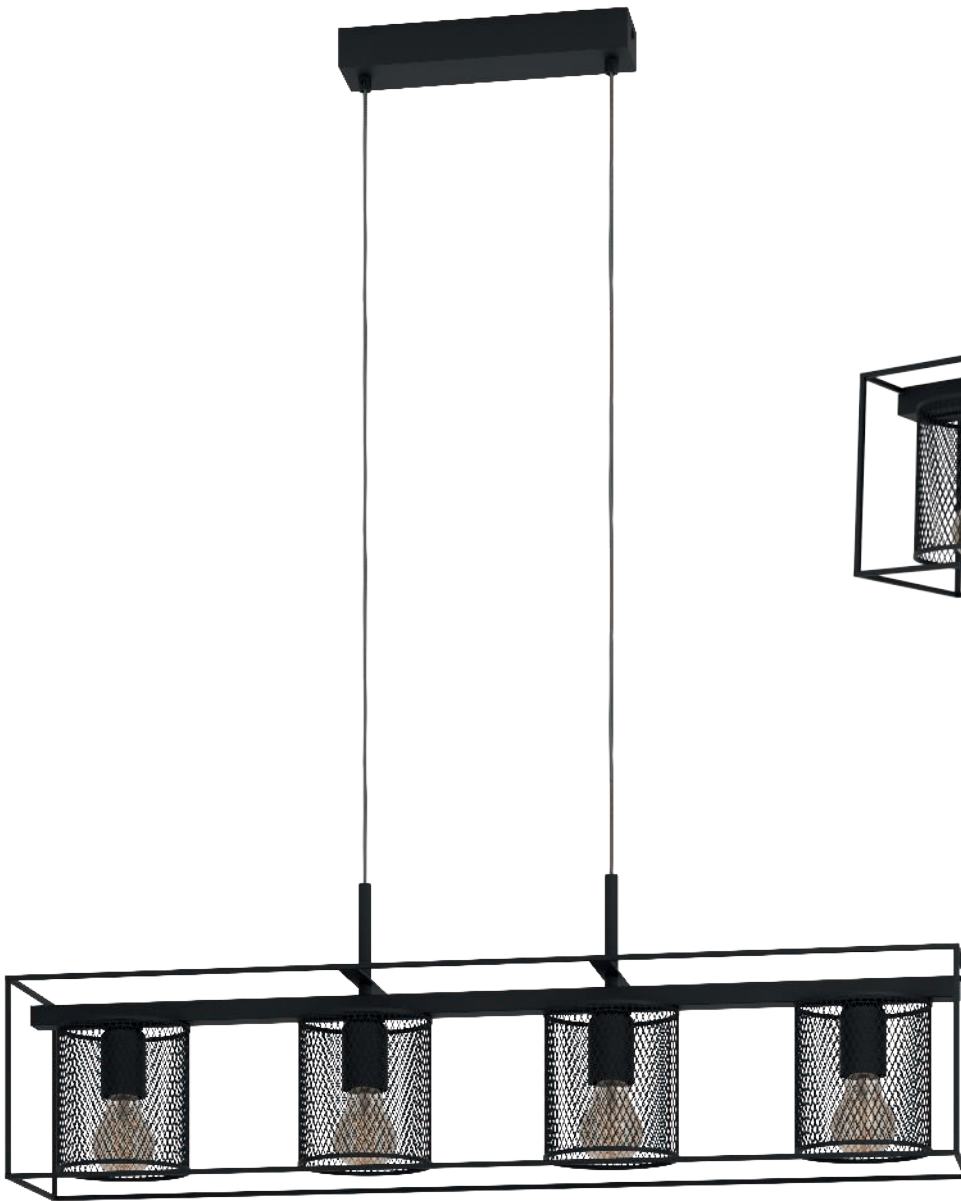

43773



43772

43773 CATTERICK

pendant light; steel, black
Hängeleuchte; Stahl, schwarz
luminaire en suspension; acier, noir

L 910, B 165, H 1100



9 002759 437732

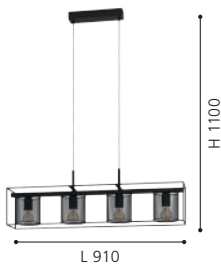

43772 CATTERICK

ceiling light; steel, black
Deckenleuchte; Stahl, schwarz
plafonnier; acier, noir

L 350, B 165, H 190



9 002759 437725



43771 CATTERICK

ceiling light; steel, black
Deckenleuchte; Stahl, schwarz
plafonnier; acier, noir

L 165, B 165, H 190



9 002759 437718





43771



43774

43774 CATTERICK

table light; steel, black
Tischleuchte; Stahl, schwarz
luminaire de table; acier, noir

L 165, B 165, H 190



E27



1x 40W



9 002759 437749

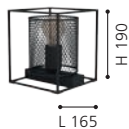

DESIGN
HIGHLIGHT
DETAIL





43728

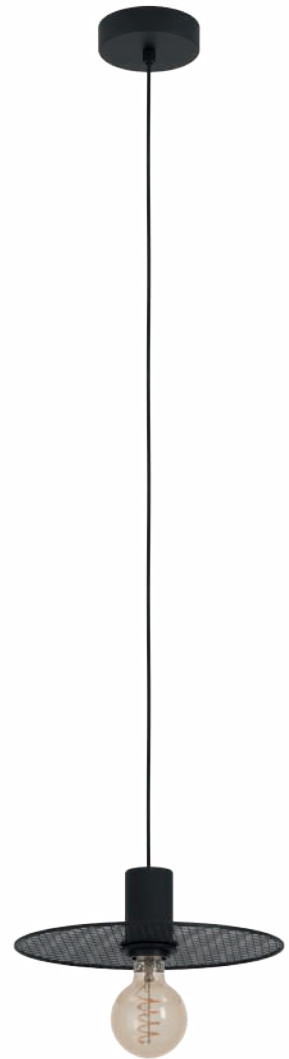

43731

43728 IKESTON

ceiling light; steel, black
Deckenleuchte; Stahl, schwarz
plafonnier; acier, noir

H 130, Ø 530



E27



3x 40W



9 002759 437282



43731 IKESTON

pendant light; steel, black
Hängeleuchte; Stahl, schwarz
luminaire en suspension; acier, noir

H 1100, Ø 280



E27



1x 40W



9 002759 437312

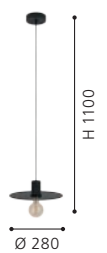



43729



43732

43732 IKESTON

pendant light; steel, black
Hängeleuchte; Stahl, schwarz
luminaire en suspension; acier, noir

L 980, B 280, H 1100



E27



4x 40W



9 002759 437329

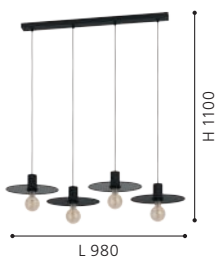

43729 IKESTON

ceiling light; steel, black
Deckenleuchte; Stahl, schwarz
plafonnier; acier, noir

L 950, B 330, H 120



E27



4x 40W



9 002759 437299





43722



43721

43722 SPEKE

ceiling light; steel, black
Deckenleuchte; Stahl, schwarz
plafonnier; acier, noir

L 1560, B 310, H 105



E27



11x 40W



9 002759 437220

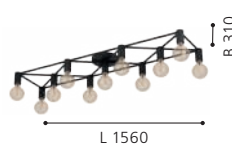

L 1560

B 310

43721 SPEKE

ceiling light; steel, black
Deckenleuchte; Stahl, schwarz
plafonnier; acier, noir

L 415, B 310, H 105



E27



5x 40W



9 002759 437213

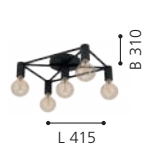

L 415

B 310



43821



43822

43821 SEDBERGH

pendant light; steel, black / glass, black-grey-transparent
Hängeleuchte; Stahl, schwarz / Glas, schwarz-grau-transparent
luminaire en suspension; acier, noir / verre, noir-gris-transparent

H 1100, Ø 200



E27



1x 40W



9 002759 438210



43822 SEDBERGH

pendant light; steel, black / glass, black-grey-transparent
Hängeleuchte; Stahl, schwarz / Glas, schwarz-grau-transparent
luminaire en suspension; acier, noir / verre, noir-gris-transparent

L 900, B 200, H 1100



E27



3x 40W



9 002759 438227



DESIGN
HIGHLIGHT
DETAIL



DETAIL 43395

The mounting bracket of the light fitting can be individually adjusted.
Die Aufhängung der Leuchtenköpfe kann individuell eingestellt werden.
La suspension des têtes de luminaire est réglable.

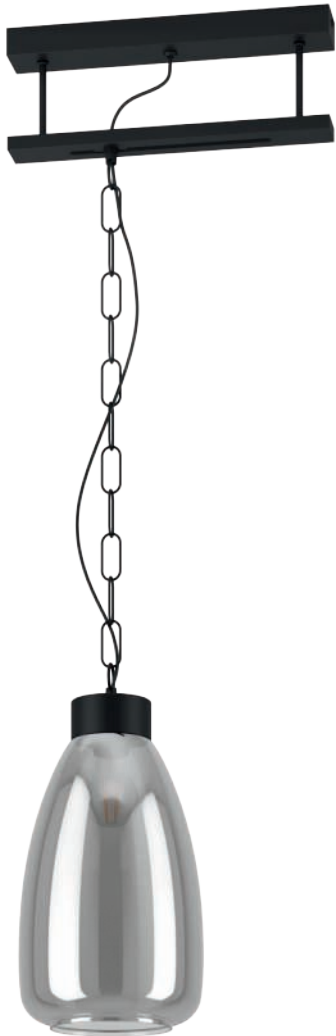

43394



43395

43394 BRICKFIELD

pendant light; steel, black / glass vaporized, black-transparent
Hängeleuchte; Stahl, schwarz / Glas bedampft, schwarz-transparent
luminaire en suspension; acier, noir / verre vaporisé, noir transparent

L 350, B 200, H 1085



E27



1x 40W



9 002759 433949



43395 BRICKFIELD

pendant light; steel, black / glass vaporized, black-transparent
Hängeleuchte; Stahl, schwarz / Glas bedampft, schwarz-transparent
luminaire en suspension; acier, noir / verre vaporisé, noir transparent

L 770, B 200, H 1085



E27



2x 40W



9 002759 433956

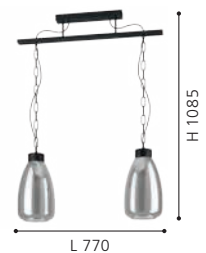



43308



43309

43308 FORESTBURG

ceiling light; steel, black / glass vaporized, black-transparent
 Deckenleuchte; Stahl, schwarz / Glas bedampft, schwarz-transparent
 plafonnier; acier, noir / verre vaporisé, noir transparent

H 275, Ø 665



E27



3x 40W



9 002759 433086



43309 FORESTBURG

wall light; steel, black / glass vaporized, black-transparent
 Wandleuchte; Stahl, schwarz / Glas bedampft, schwarz-transparent
 applique; acier, noir / verre vaporisé, noir transparent

L 115, H 290, A 310



E27



1x 40W



9 002759 433093



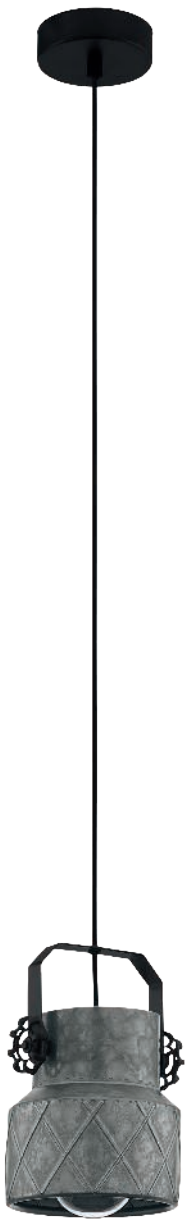

39854



39855

39854 HILCOTT

pendant light; steel, black / steel, zinc-plated
 Hängeleuchte; Stahl, schwarz / Stahl, verzinkt
 luminaire en suspension; acier, noir / acier, galvanisé

H 1100, Ø 145



E27 1x 40W



9 002759 398545



39855 HILCOTT

pendant light; steel, black / steel, zinc-plated
 Hängeleuchte; Stahl, schwarz / Stahl, verzinkt
 luminaire en suspension; acier, noir / acier, galvanisé

L 1160, B 145, H 1100



E27 5x 40W



9 002759 398552

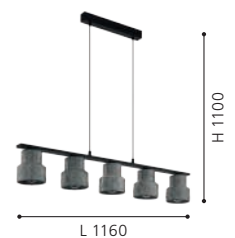



39868



39857



39856

39868 HILCOTT

wall light; steel, black / steel, zinc-plated
Wandleuchte; Stahl, schwarz / Stahl, verzinkt
applique; acier, noir / acier, galvanisé

L 160, H 200, A 245



E27



1x 40W



9 002759 398682



39857 HILCOTT

table light; steel, black / steel, zinc-plated
Tischleuchte; Stahl, schwarz / Stahl, verzinkt
luminaire de table; acier, noir / acier, galvanisé

L 265, B 160, H 480, Base: Ø 170



E27



1x 40W



9 002759 398576



39856 HILCOTT

pendant light; steel, black / steel, zinc-plated
Hängeleuchte; Stahl, schwarz / Stahl, verzinkt
luminaire en suspension; acier, noir / acier, galvanisé

H 1500, Ø 675



E27



5x 40W



9 002759 398569

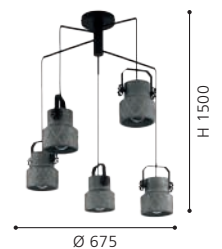



43444



43445



43446

43444 TURROCK

wall / ceiling light; steel, grey-patina, black
Wand- / Deckenleuchte; Stahl, grau-patina, schwarz
applique / plafonnier; acier, gris patiné, noir

L 160, B 160, H 300



E27



1x 28W



9 002759 434441



L 160

H 300

43445 TURROCK

wall / ceiling light; steel, grey-patina, black
Wand- / Deckenleuchte; Stahl, grau-patina, schwarz
applique / plafonnier; acier, gris patiné, noir

L 475, B 160, H 300



E27



2x 28W



9 002759 434458



L 475

H 300

43446 TURROCK

wall / ceiling light; steel, grey-patina, black
Wand- / Deckenleuchte; Stahl, grau-patina, schwarz
applique / plafonnier; acier, gris patiné, noir

L 750, B 160, H 300



E27



3x 28W



9 002759 434465



L 750

H 300



43447

43447 TURROCK

pendant light; steel, grey-patina, black
Hängeleuchte; Stahl, grau-patina, schwarz
luminaire en suspension; acier, gris patiné, noir

L 880, B 180, H 1100



E27



3x 28W



9 002759 434472



DESIGN
HIGHLIGHT
DETAIL



DETAIL TAKELEY

The arms of the luminaires are individually adjustable.
Die Arme der Leuchten sind individuell einstellbar.
Les bras des luminaires sont réglables individuellement.



43562

43562 TAKELEY

ceiling light; steel, black
Deckenleuchte; Stahl, schwarz
plafonnier; acier, noir

B 1980, H 1325



E27



2x 28W



9 002759 435622

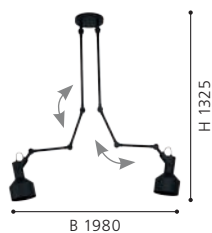

43561 TAKELEY

ceiling light; steel, black
Deckenleuchte; Stahl, schwarz
plafonnier; acier, noir

H 1325, Ø 150



E27



1x 28W



9 002759 435615

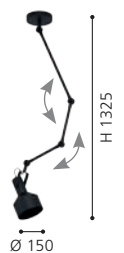



43561





43431



43432



43433

43431 BARNSTAPLE 1

spot; wood, steel, black / steel, black
Spot; Holz, Stahl, schwarz / Stahl, schwarz
spot; bois, acier, noir / acier, noir

L 160, B 160



E27 1x 28W



9 002759 434311

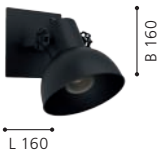

L 160

B 160

43432 BARNSTAPLE 1

spot; wood, steel, black / steel, black
Spot; Holz, Stahl, schwarz / Stahl, schwarz
spot; bois, acier, noir / acier, noir

L 475, B 90



E27 2x 40W



9 002759 434328



L 475

B 90

43433 BARNSTAPLE 1

spot; wood, steel, black / steel, black
Spot; Holz, Stahl, schwarz / Stahl, schwarz
spot; bois, acier, noir / acier, noir

L 750, B 90



E27 3x 40W



9 002759 434335



L 750

B 90



43434



43726



43434 BARNSTAPLE 1

spot; wood, steel, black / steel, black
Spot; Holz, Stahl, schwarz / Stahl, schwarz
spot; bois, acier, noir / acier, noir

L 450, B 450



E27



4x 40W



9 002759 434342



43726 SHIREBROOK

pendant light; steel, wood, black
Hängeleuchte; Stahl, Holz, schwarz
luminaire en suspension; acier, bois, noir

L 1000, B 250, H 1100



E27



4x 40W



9 002759 437268

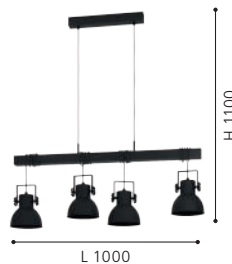



49649

49653

49652

49649 BARNSTAPLE

spot; wood, steel, brown-patina, black / steel, used look Zinc Spot; Holz, Stahl, braun-patina, schwarz / Stahl, used look Zink spot; bois, acier, marron patiné, noir / acier, look zinc usé

L 475, B 90



49652 BARNSTAPLE

spot; wood, steel, brown-patina, black / steel, used look Zinc Spot; Holz, Stahl, braun-patina, schwarz / Stahl, used look Zink spot; bois, acier, marron patiné, noir / acier, look zinc usé

L 750, B 90



49653 BARNSTAPLE

spot; wood, steel, brown-patina, black / steel, used look Zinc Spot; Holz, Stahl, braun-patina, schwarz / Stahl, used look Zink spot; bois, acier, marron patiné, noir / acier, look zinc usé

L 450, B 450

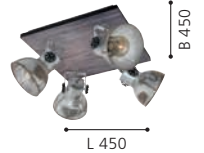



49648

49648 BARNSTAPLE

spot; wood, steel, brown-patina, black / steel, used look Zinc
Spot; Holz, Stahl, braun-patina, schwarz / Stahl, used look Zinc
spot; bois, acier, marron patiné, noir / acier, look zinc usé

L 160, B 160



E27



1x 40W



9 002759 496487



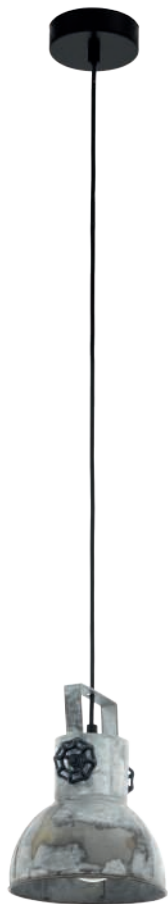

49619



49647



49722

49619 BARNSTAPLE

pendant light; steel, black / steel, used look Zinc
 Hängeleuchte; Stahl, schwarz / Stahl, used look Zinc
 luminaire en suspension; acier, noir / acier, look zinc usé

H 1100, Ø 175



E27 1x 40W



9 002759 496197



49647 BARNSTAPLE

pendant light; wood, steel, brown-patina, black / steel, used look Zinc
 Hängeleuchte; Holz, Stahl, braun-patina, schwarz / Stahl, used look Zinc
 luminaire en suspension; bois, acier, marron patiné, noir / acier, look zinc usé

H 1500, Ø 270



E27 3x 40W



9 002759 496470



49722 BARNSTAPLE

floor light; wood, steel, brown-patina, black / steel, used look Zinc
 Stehleuchte; Holz, Stahl, braun-patina, schwarz / Stahl, used look Zinc
 lampadaire; bois, acier, marron patiné, noir / acier, look zinc usé

H 1580, Base: Ø 270



E27 2x 40W



9 002759 497224

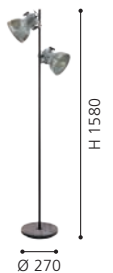



49718

49718 BARNSTAPLE

table light; wood, steel, brown-patina, black / steel, used look Zinc

Tischleuchte; Holz, Stahl, braun-patina, schwarz / Stahl, used look Zink

luminaire de table; bois, acier, marron patiné, noir / acier, look zinc usé

B 175, H 400, Base: Ø 180



E27



1x 40W



9 002759 497187

DESIGN
HIGHLIGHT
DETAIL





43168



43164



43162

43168 LUBENHAM 1

pendant light; steel, nickel-antique, creme
 Hängeleuchte; Stahl, nickel-antik, creme
 luminaire en suspension; acier, nickel antique, crème

L 900, B 200, H 1100



E27 3x 28W



9 002759 431686

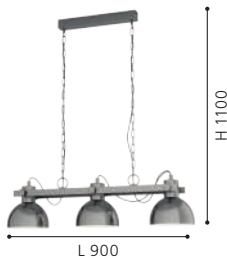

43162 LUBENHAM

pendant light; steel, wood, black, brown
 Hängeleuchte; Stahl, Holz, schwarz, braun
 luminaire en suspension; acier, bois, noir, marron

H 1100, Ø 300



E27 1x 28W



9 002759 431624

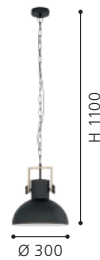

43164 LUBENHAM

wall light; steel, wood, black, brown
 Wandleuchte; Stahl, Holz, schwarz, braun
 applique; acier, bois, noir, marron

L 175, H 205, A 210



E27 1x 28W



9 002759 431648





43165 LUBENHAM

table light; steel, wood, black, brown
Tischleuchte; Stahl, Holz, schwarz, braun
luminaire de table; acier, bois, noir, marron

H 570, Base: Ø 180



E27 1x 28W



9 002759 431655



43166 LUBENHAM

floor light; steel, wood, black, brown
Stehleuchte; Stahl, Holz, schwarz, braun
lampadaire; acier, bois, noir, marron

L 475, B 300, H 1600, Base: Ø 300



E27 1x 28W



9 002759 431662

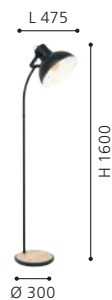

43163 LUBENHAM

pendant light; steel, wood, black, brown
Hängeleuchte; Stahl, Holz, schwarz, braun
luminaire en suspension; acier, bois, noir, marron

L 900, B 200, H 1100



E27 3x 28W



9 002759 431631

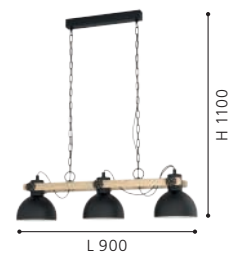



43435



43436



DETAIL WINKWORTH 1

The distance between light fitting and ceiling can be individually adjusted using the additional weight.

Der Abstand der Leuchte zur Decke ist durch das zusätzliche Gewicht individuell verstellbar.

L'espace séparant les têtes de luminaire du plafond peut être réglé grâce au poids supplémentaire.

43435 WINKWORTH 1

pendant light; steel, black
Hängeleuchte; Stahl, schwarz
luminaire en suspension; acier, noir

H 910 - 1900, Ø 380



E27 1x 40W



9 002759 434359

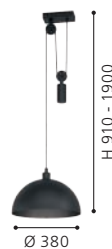

Ø 380

43436 WINKWORTH 1

pendant light; steel, black
Hängeleuchte; Stahl, schwarz
luminaire en suspension; acier, noir

L 1180, B 380, H 910 - 1900



E27 2x 40W



9 002759 434366



L 1180



43621



43622

43621 EBURY

pendant light; steel, black, white
Hängeleuchte; Stahl, schwarz, weiss
luminaire en suspension; acier, noir, blanc

H 1100, Ø 380



E27



1x 60W



9 002759 436216



43622 EBURY

pendant light; steel, grey, white
Hängeleuchte; Stahl, grau, weiss
luminaire en suspension; acier, gris, blanc

H 1100, Ø 380



E27



1x 60W



9 002759 436223



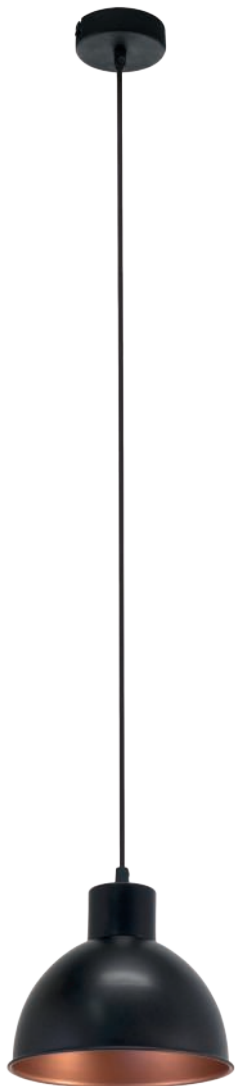

49238

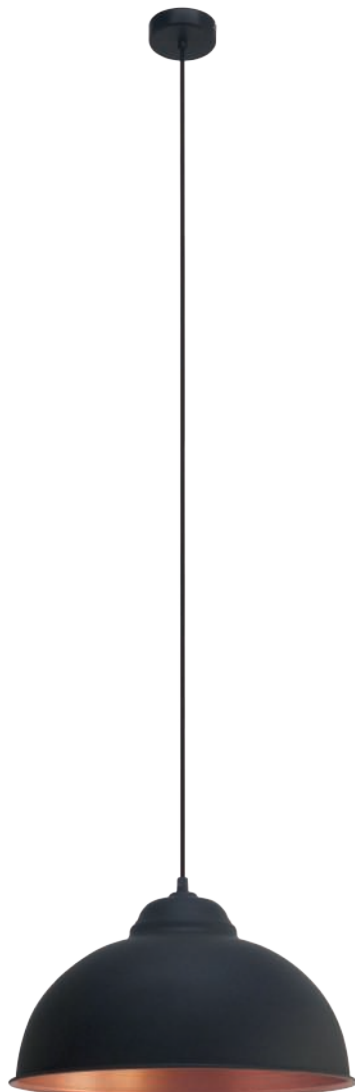

49247



43299

49238 TRURO 1

pendant light; steel, black, copper
Hängeleuchte; Stahl, schwarz, kupfer
luminaire en suspension; acier, noir, cuivre

H 1100, Ø 210



E27 1x 60W



9 002759 492380



49247 TRURO 2

pendant light; steel, black, copper
Hängeleuchte; Stahl, schwarz, kupfer
luminaire en suspension; acier, noir, cuivre

H 1100, Ø 370



E27 1x 60W



9 002759 492472



43299 ROCKINGHAM

pendant light; steel, black, brown
Hängeleuchte; Stahl, schwarz, braun
luminaire en suspension; acier, noir, marron

H 1500, Ø 530



E27 1x 40W



9 002759 432997





49819

49819 GRANTHAM 1

pendant light; steel, antique-brown, beige

Hängeleuchte; Stahl, antik-braun, beige

luminaire en suspension; acier, marron antique, beige

H 1100, Ø 370



E27



1x 60W



9 002759 498191



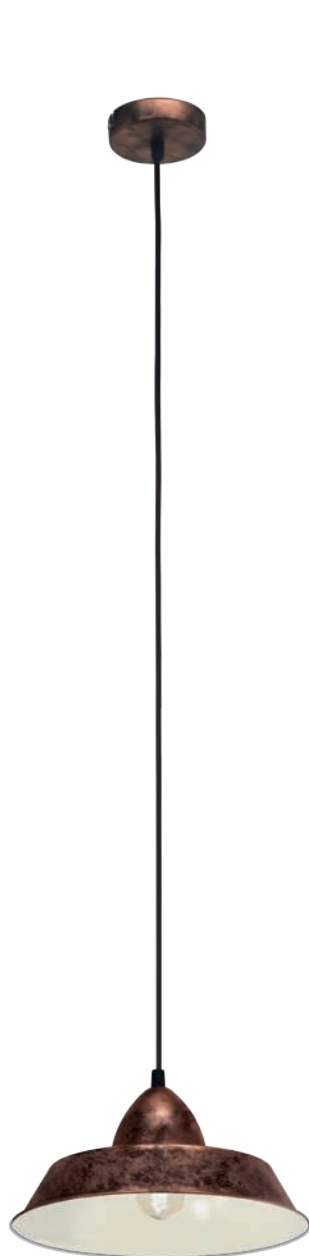

49243



49235

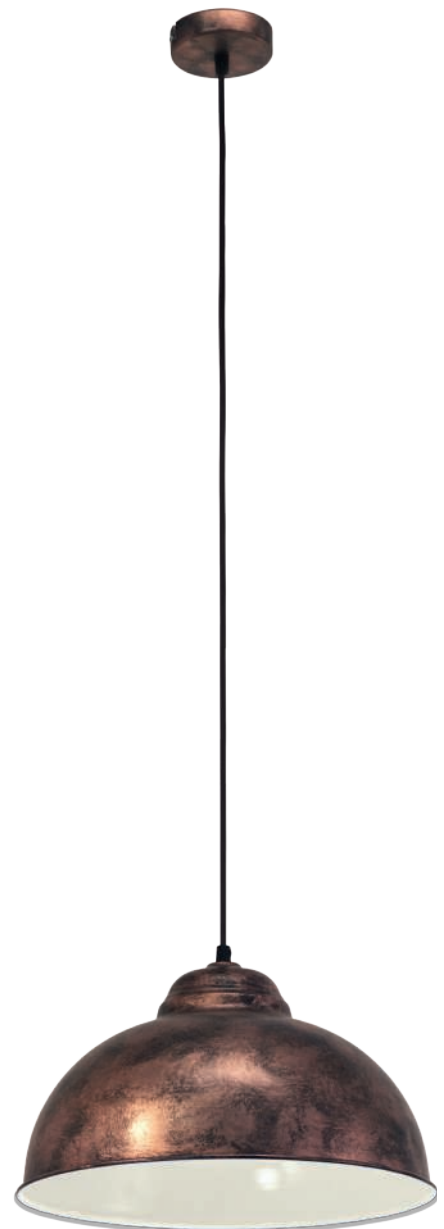

49248

49243 AUCKLAND

pendant light; steel, copper-coloured antique
Hängeleuchte; Stahl, kupferfarben-antik
luminaire en suspension; acier, cuivré antique

H 1100, Ø 260



E27 1x 60W



9 002759 492434

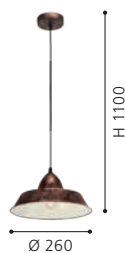

49235 TRURO

pendant light; steel, copper-coloured antique
Hängeleuchte; Stahl, kupferfarben-antik
luminaire en suspension; acier, cuivré antique

H 1100, Ø 155



E27 1x 40W



9 002759 492359

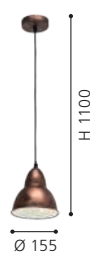

49248 TRURO 2

pendant light; steel, copper-coloured antique
Hängeleuchte; Stahl, kupferfarben-antik
luminaire en suspension; acier, cuivré antique

H 1100, Ø 370



E27 1x 60W



9 002759 492489





49492

49492 PRIDDY 1

pendant light; steel, copper-coloured antique
Hängeleuchte; Stahl, kupferfarben-antik
luminaire en suspension; acier, cuivré antique

H 1100, Ø 155



E27



1x 40W



9 002759 494926





49464

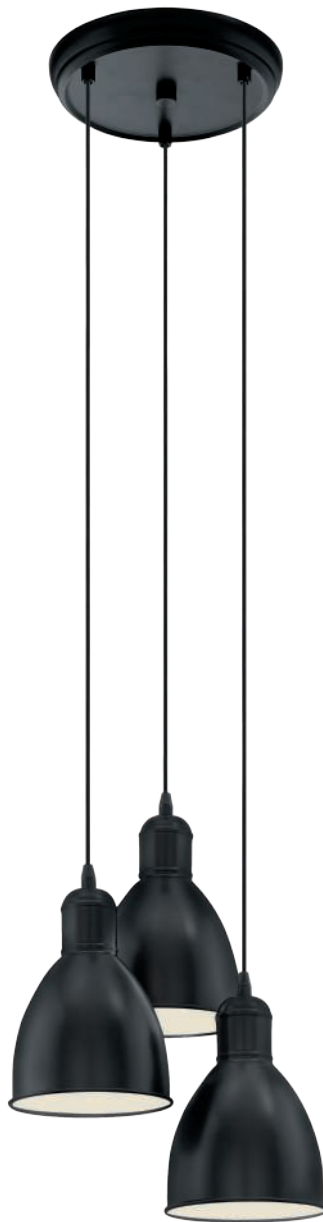

49465

49464 PRIDDY

pendant light; steel, black, white
Hängeleuchte; Stahl, schwarz, weiss
luminaire en suspension; acier, noir, blanc

H 1100, Ø 155



E27 1x 40W



9 002759 494643



49465 PRIDDY

pendant light; steel, black, white
Hängeleuchte; Stahl, schwarz, weiss
luminaire en suspension; acier, noir, blanc

H 1100, Ø 325

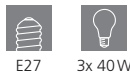

E27 3x 40W



9 002759 494650



49466 PRIDDY

pendant light; steel, black, white
Hängeleuchte; Stahl, schwarz, weiss
luminaire en suspension; acier, noir, blanc

L 975, B 155, H 1100



E27 4x 40W



9 002759 494667

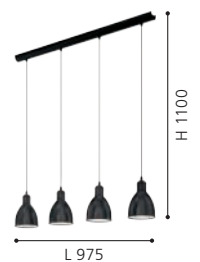



49466





49468



49469

49468 PRIDDY

wall light; steel, black, white
Wandleuchte; Stahl, schwarz, weiss
applique; acier, noir, blanc

L 130, H 215, A 200



E27 1x 40W



9 002759 494681



49469 PRIDDY

table light; steel, black, white
Tischleuchte; Stahl, schwarz, weiss
luminaire de table; acier, noir, blanc

H 425, Base: Ø 155



E27 1x 40W



9 002759 494698



49471 PRIDDY

floor light; steel, black, white
Stehleuchte; Stahl, schwarz, weiss
lampadaire; acier, noir, blanc

H 1370, Base: Ø 230



E27 1x 40W



9 002759 494711

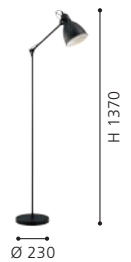



49471



DETAIL 43184

The luminaire can be individually extended by the movable and extendable arm.

Die Leuchte kann durch den beweglichen und ausziehbaren Arm individuell verlängert werden.

Le luminaire peut être prolongé individuellement par le bras mobile et extensible.



43184 TREBURLEY

wall light; steel, black, gold
Wandleuchte; Stahl, schwarz, gold
applique; acier, noir, or

L 155, B 650, H 200



E27



1x 28W



9 002759 431846



43353 COVALEDA 1

pendant light; steel, black, gold
Hängeleuchte; Stahl, schwarz, gold
luminaire en suspension; acier, noir, or

H 1370, Ø 455



E27



1x 60W



9 002759 433536

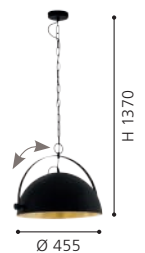



43353



49617

49618



49877

DESIGN
HIGHLIGHT
DETAIL



49617 COVALEDA

table light; wood, steel, black, brass, gold
Tischleuchte; Holz, Stahl, schwarz, messing, gold
luminaire de table; bois, acier, noir, laiton, or

H 735, Ø 380



E27 1x 60W



Ø 380

H 735



9 002759 496173

49618 COVALEDA

floor light; wood, steel, black, brass, gold
Stehleuchte; Holz, Stahl, schwarz, messing, gold
lampadaire; bois, acier, noir, laiton, or

H 1640, Ø 550



E27 1x 60W



Ø 550

H 1640



9 002759 496180

49877 COVALEDA

floor light; wood, steel, white, chrome, silver
Stehleuchte; Holz, Stahl, weiss, chrom, silber
lampadaire; bois, acier, blanc, chrome, argent

H 1640, Ø 550

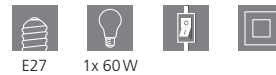

E27 1x 60W

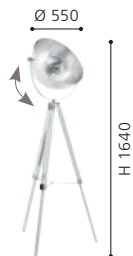

Ø 550

H 1640



9 002759 498771



DESIGN
HIGHLIGHT
DETAIL



49761

49761 EMBLETON

pendant light; steel, black
Hängeleuchte; Stahl, schwarz
luminaire en suspension; acier, noir

H 1100, Ø 305



E27



1x 60W



9 002759 497613



49762 EMBLETON

pendant light; steel, black
Hängeleuchte; Stahl, schwarz
luminaire en suspension; acier, noir

H 1500, Ø 460



E27



1x 60W



9 002759 497620

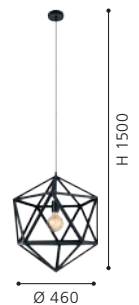



49762





DETAIL MARDYKE

This luminaire series has a unique look with the mixture of steel and clear glass.

Diese Leuchterserie verfügt mit der Mischung aus Stahl und Klarglas über eine einzigartige Optik.

Cette série de luminaires a un look unique avec le mélange d'acier et de verre transparent.

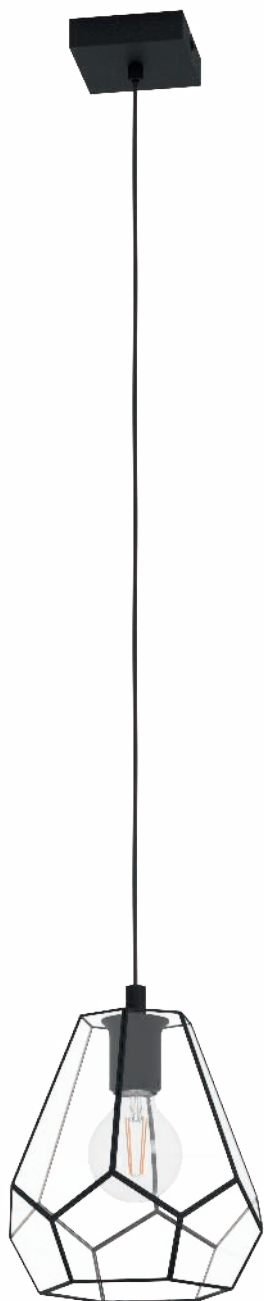

43643



43645



43646

43643 MARDYKE

pendant light; steel, black / glass, clear
Hängeleuchte; Stahl, schwarz / Glas, klar
luminaire en suspension; acier, noir / verre, transparent

H 1100, Ø 230



E27



1x 40W



9 002759 436438



43645 MARDYKE

wall light; steel, black / glass, clear
Wandleuchte; Stahl, schwarz / Glas, klar
applique; acier, noir / verre, transparent

L 145, H 205, A 195



E27



1x 40W



9 002759 436452

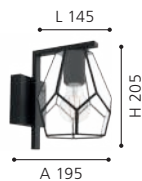

43646 MARDYKE

table light; steel, black / glass, clear
Tischleuchte; Stahl, schwarz / Glas, klar
luminaire de table; acier, noir / verre, transparent

L 190, B 150, H 505, Base: B 188, T 128



E27



1x 40W



9 002759 436469

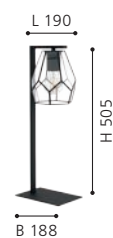



43644

43644 MARDYKE

pendant light; steel, black / glass, clear

Hängeleuchte; Stahl, schwarz / Glas, klar

luminaire en suspension; acier, noir / verre, transparent

L 775, B 145, H 1100



E27



3x 40W



9 002759 436445

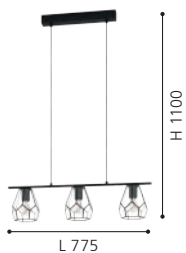

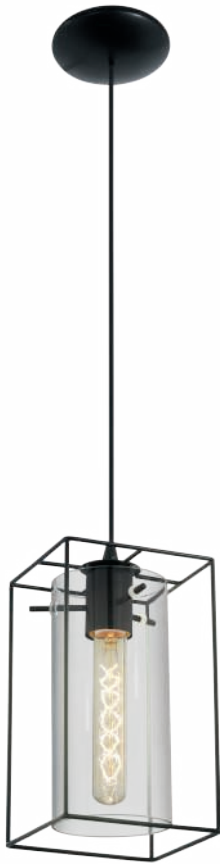

49495



49496

49495 LONCINO

pendant light; steel, black / smoked glass, black-transparent
 Hängeleuchte; Stahl, schwarz / Rauchglas, schwarz-transparent
 luminaire en suspension; acier, noir / verre fumé, noir transparent

L 150, B 150, H 1100



E27 1x 60W



49496 LONCINO

pendant light; steel, black / smoked glass, black-transparent
 Hängeleuchte; Stahl, schwarz / Rauchglas, schwarz-transparent
 luminaire en suspension; acier, noir / verre fumé, noir transparent

L 745, B 150, H 1100



E27 3x 60W





49392



49394



49393

49392 CHARTERHOUSE

ceiling light; steel, black / glass, clear
Deckenleuchte; Stahl, schwarz / Glas, klar
plafonnier; acier, noir / verre, transparent

L 360, B 360, H 160



E27

2x 60W



9 002759 493929

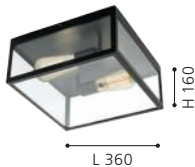

49394 CHARTERHOUSE

wall light; steel, black / glass, clear
Wandleuchte; Stahl, schwarz / Glas, klar
applique; acier, noir / verre, transparent

L 160, H 280, A 150



E27

1x 60W



9 002759 493943



49393 CHARTERHOUSE

pendant light; steel, black / glass, clear
Hängeleuchte; Stahl, schwarz / Glas, klar
luminaire en suspension; acier, noir / verre, transparent

L 730, B 200, H 1100



E27

3x 60W



9 002759 493936





49564

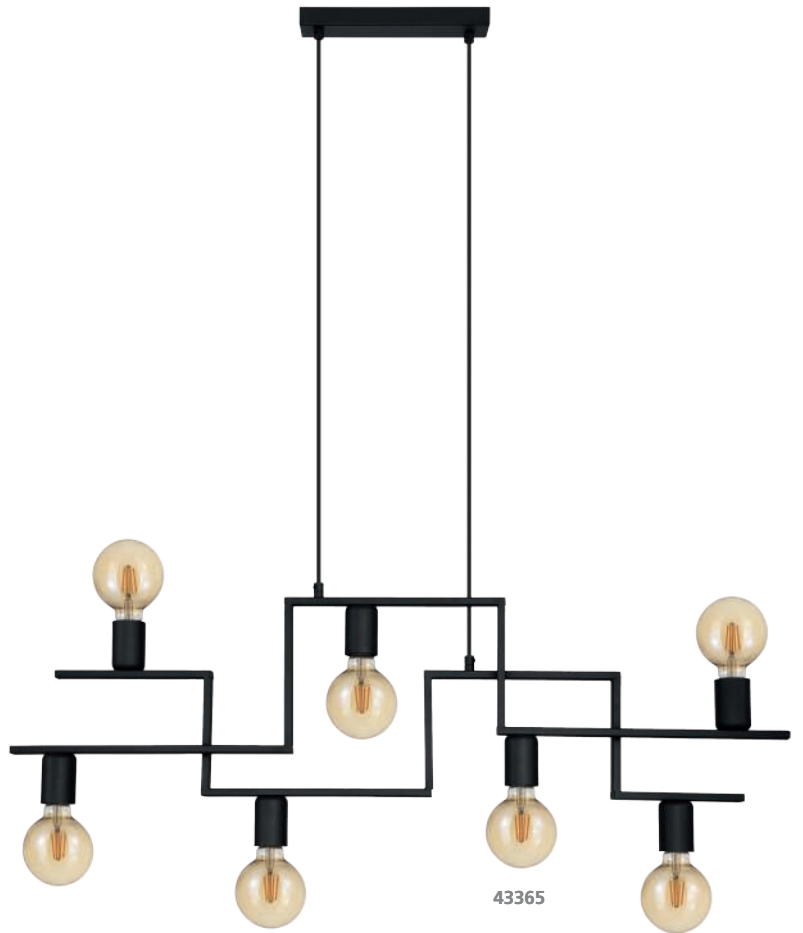

43365

49564 ELSWICK

pendant light; steel, black
Hängeleuchte; Stahl, schwarz
luminaire en suspension; acier, noir

L 1100, B 250, H 1500



E27



3x 60W



9 002759 495640



43365 FEMBAR

pendant light; steel, black
Hängeleuchte; Stahl, schwarz
luminaire en suspension; acier, noir

L 1005, B 40, H 1100



E27



7x 60W



9 002759 433659

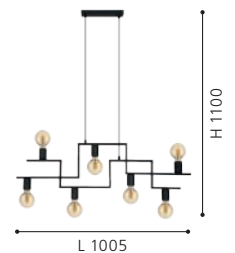



43126



DETAIL EXMOOR

The arms of the luminaire are individually adjustable.

Die Arme der Leuchte sind individuell einstellbar.

Les bras du luminaire sont réglables individuellement.



49037

43126 WILMCOTE

ceiling light; steel, black
Deckenleuchte; Stahl, schwarz
plafonnier; acier, noir

H 380, Ø 280



E27



3x 60W



9 002759 431266



49037 EXMOOR

ceiling light; steel, black
Deckenleuchte; Stahl, schwarz
plafonnier; acier, noir

H 400, Ø 960



E27



8x 60W



9 002759 490379

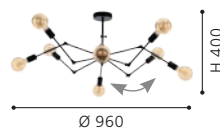



49684



49685

49684 OLDBURY

pendant light; steel, wood, black, brown rustic
 Hängeleuchte; Stahl, Holz, schwarz, braun rustikal
 luminaire en suspension; acier, bois, noir, marron rustique

L 860, B 260, H 1100



E27



2x 60W



9 002759 496845



49685 OLDBURY

pendant light; steel, wood, black, brown rustic
 Hängeleuchte; Stahl, Holz, schwarz, braun rustikal
 luminaire en suspension; acier, bois, noir, marron rustique

L 1180, B 260, H 1100



E27



3x 60W



9 002759 496852





49809



43522



43152

49809 PORT SETON

pendant light; steel, antique-brown
Hängeleuchte; Stahl, antik-braun
luminaire en suspension; acier, marron antique

H 1100, Ø 130



E27



1x 60W



9 002759 498092

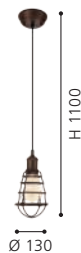

Ø 130

H 1100

43522 TOWNSHEND 4

ceiling light; steel, antique-brown
Deckenleuchte; Stahl, antik-braun
plafonnier; acier, marron antique

L 550, B 140, H 260



E27



3x 60W



9 002759 435226



L 550

H 260

43152 TOWNSHEND 4

wall light; steel, black, brown
Wandleuchte; Stahl, schwarz, braun
applique; acier, noir, marron

L 80, H 190, A 185



E27



1x 10W



9 002759 431525



A 185

H 190

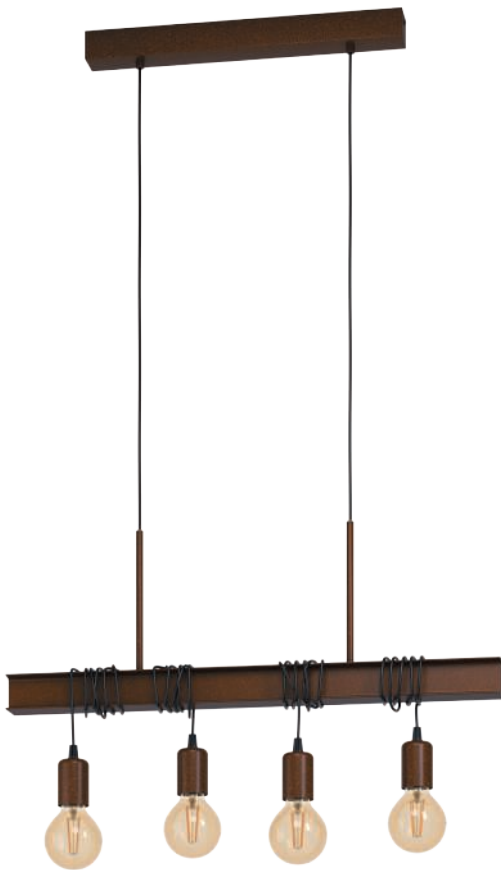

43523



43524



DETAIL TOWNSHEND 4

Thanks to the long cable of the luminaire heads the height can be adjusted individually.

Durch das lange Kabel der Leuchtenköpfe kann die Höhe individuell eingestellt werden.

Grâce au long câble des têtes de luminaire la hauteur peut être réglée individuellement.

43523 TOWNSHEND 4

pendant light; steel, antique-brown, black
Hängeleuchte; Stahl, antik-braun, schwarz
luminaire en suspension; acier, marron antique, noir

L 700, B 140, H 1100



E27



4x 60W



9 002759 435233



43524 TOWNSHEND 4

pendant light; steel, antique-brown, black
Hängeleuchte; Stahl, antik-braun, schwarz
luminaire en suspension; acier, marron antique, noir

L 1500, B 140, H 1100



E27



8x 60W



9 002759 435240

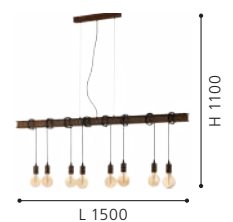

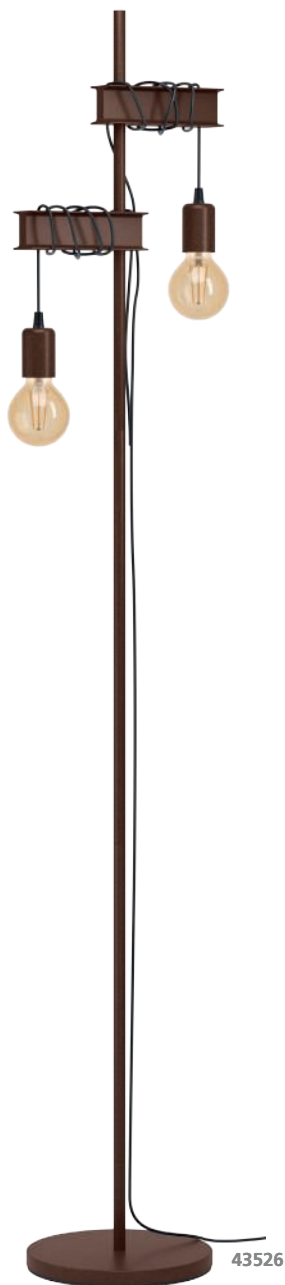

43526



49859



43525

43526 TOWNSHEND 4

floor light; steel, antique-brown, black
 Stehleuchte; Stahl, antik-braun, schwarz
 lampadaire; acier, marron antique, noir

L 260, B 250, H 1690, Base: Ø 250



E27 2x 10W



9 002759 435264

43525 TOWNSHEND 4

table light; steel, antique-brown, black
 Tischleuchte; Stahl, antik-braun, schwarz
 luminaire de table; acier, marron antique, noir

L 165, B 155, H 500, Base: Ø 155



E27 1x 10W



9 002759 435257

49859 TOWNSHEND 4

pendant light; steel, antique-brown
 Hängeleuchte; Stahl, antik-braun
 luminaire en suspension; acier, marron antique

L 1005, B 70, H 1100



E27 6x 60W



9 002759 498597



43733



43733 PRESTWICK 2

table light; wood, brown
Tischleuchte; Holz, braun
luminaire de table; bois, marron

L 95, B 95, H 95



E27



1x 40W



9 002759 437336





43549



43548



43734



43548 PRESTWICK 1

table light; steel, auburn
Tischleuchte; Stahl, rostbraun
luminaire de table; acier, brun rouille

L 100, B 100, H 100



E27 1x 40W



9 002759 435486



43549 PRESTWICK 2

table light; steel, dark bronze
Tischleuchte; Stahl, bronze dunkel
luminaire de table; acier, bronze foncé

L 100, B 100, H 100



E27 1x 40W



9 002759 435493



43734 PRESTWICK 2

table light; wood, black
Tischleuchte; Holz, schwarz
luminaire de table; bois, noir

L 95, B 95, H 95



E27 1x 40W



9 002759 437343





49076



49077



49078

49076 GATEBECK

spot; wood, natural / steel, black
Spot; Holz, natur / Stahl, schwarz
spot; bois, naturel / acier, noir

L 110, B 110, H 205

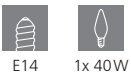

E14 1x 40W



9 002759 490768



49077 GATEBECK

spot; wood, natural / steel, black
Spot; Holz, natur / Stahl, schwarz
spot; bois, naturel / acier, noir

L 360, B 110, H 205

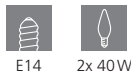

E14 2x 40W



9 002759 490775

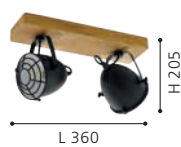

49078 GATEBECK

spot; wood, natural / steel, black
Spot; Holz, natur / Stahl, schwarz
spot; bois, naturel / acier, noir

L 590, B 110, H 205

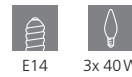

E14 3x 40W



9 002759 490782





49079

49079 GATEBECK

spot; wood, natural / steel, black
Spot; Holz, natur / Stahl, schwarz
spot; bois, naturel / acier, noir

L 300, B 300, H 205



E14



4x 40W



9 002759 490799

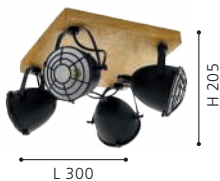



43468 LAYHAM

pendant light; wood, steel, brown, black
 Hängeleuchte; Holz, Stahl, braun, schwarz
 luminaire en suspension; bois, acier, marron, noir

L 960, B 85, H 1100



E27 5x 60W



9 002759 434687

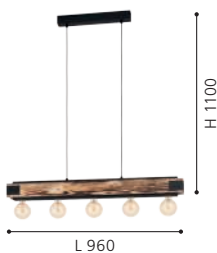

43466 LAYHAM

ceiling light; wood, steel, brown, black
 Deckenleuchte; Holz, Stahl, braun, schwarz
 plafonnier; bois, acier, marron, noir

L 760, B 85, H 100



E27 4x 60W



9 002759 434663



43469 LAYHAM

table light; wood, steel, brown, black
 Tischleuchte; Holz, Stahl, braun, schwarz
 luminaire de table; bois, acier, marron, noir

L 200, B 85, H 100

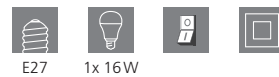

E27 1x 16W



9 002759 434694

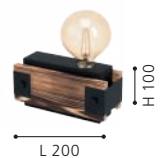



43469



43471 LAYHAM

floor light; wood, steel, brown, black
 Stehleuchte; Holz, Stahl, braun, schwarz
 lampadaire; bois, acier, marron, noir

H 1275, Base: B 260, T 245



E27



4x 60W



9 002759 434717



43471





43159



43805

43159 HARBOROUGH

pendant light; steel, black / wood, brown
 Hängeleuchte; Stahl, schwarz / Holz, braun
 luminaire en suspension; acier, noir / bois, marron

L 900, B 125, H 1100



E27



4x 40W



9 002759 431594

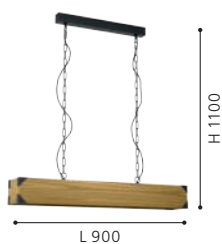

43805 EVESHAM

pendant light; steel, wood, black, brown
 Hängeleuchte; Stahl, Holz, schwarz, braun
 luminaire en suspension; acier, bois, noir, marron

L 890, B 190, H 1100



E27



3x 40W



9 002759 438050

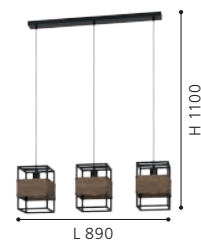



43804



43807



43806



43804 EVESHAM

ceiling light; steel, wood, black, brown
Deckenleuchte; Stahl, Holz, schwarz, braun
plafonnier; acier, bois, noir, marron

L 870, B 190, H 250



E27



3x 40W



9 002759 438043



L 870

H 250

43807 EVESHAM

table light; steel, wood, black, brown
Tischleuchte; Stahl, Holz, schwarz, braun
luminaire de table; acier, bois, noir, marron

L 190, B 180, H 250



E27



1x 40W



9 002759 438074



L 190

H 250

43806 EVESHAM

wall light; steel, wood, black, brown
Wandleuchte; Stahl, Holz, schwarz, braun
applique; acier, bois, noir, marron

L 140, H 240, A 170



E27



1x 40W



9 002759 438067



A 170

H 240



43832

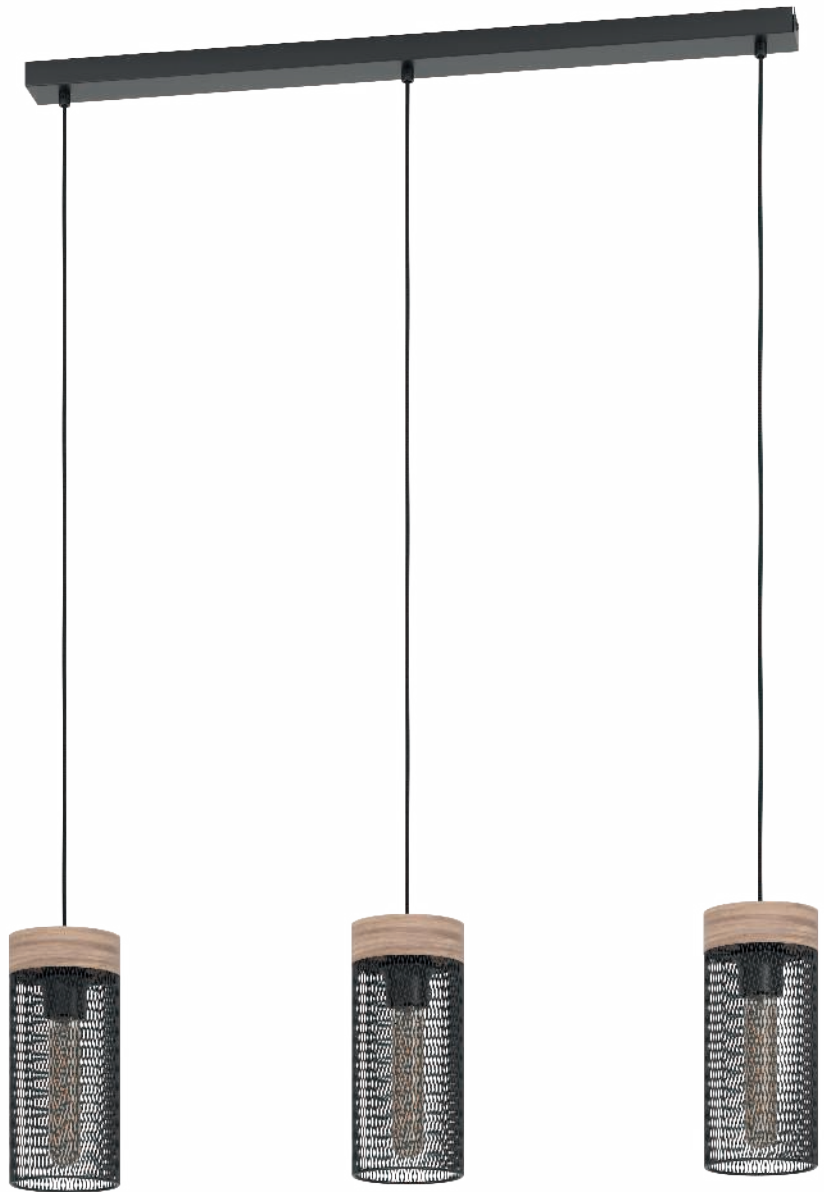

43834

43832 KILNSDALE

ceiling light; steel, wood, black, brown
Deckenleuchte; Stahl, Holz, schwarz, braun
plafonnier; acier, bois, noir, marron

H 240, Ø 380



E27 1x 40W



9 002759 438326

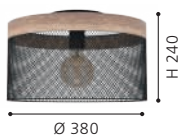

43834 KILNSDALE

pendant light; steel, wood, black, brown
Hängeleuchte; Stahl, Holz, schwarz, braun
luminaire en suspension; acier, bois, noir, marron

L 810, B 110, H 1100

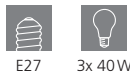

E27 3x 40W



9 002759 438340

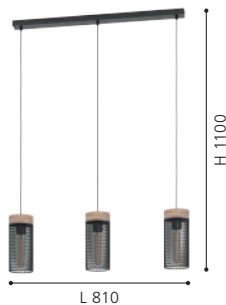

43833 KILNSDALE

pendant light; steel, wood, black, brown
Hängeleuchte; Stahl, Holz, schwarz, braun
luminaire en suspension; acier, bois, noir, marron

H 1100, Ø 110



E27 1x 40W



9 002759 438333





43833

LOFT

Separate rooms and designated spaces for working, eating and leisure are a thing of the past. Free spirits need open spaces. The loft design imparts a sense of freedom and tranquillity, and the minimalist furnishings and accessories ensure your space still feels cosy and liveable. Simple yet sophisticated. Clean lines and dark surfaces offset by brighter accents are the main features of the loft aesthetic. Recreate this chic look in your own home with EGLO.

Die Zeiten in denen Wohnen, Essen und Arbeiten in getrennten Räumen stattfanden, sind vorbei. Freigeister brauchen Freiräume, um sich wohl zu fühlen. Der Loft-Look steht für Freiheit und Gelassenheit, welcher durch minimalistische Möbel und Accessoires trotzdem gemütliches Raumgefühl gibt. Einfach und doch raffiniert. Klare Linien, dunkle Oberflächen, kontrastiert von hellen Akzenten sind die Hauptmerkmale des Loft-Looks und mit EGLO holen Sie sich diesen Loft-Charm ganz einfach nach Hause.

Finie l'époque où l'on vivait, mangeait et travaillait dans des pièces distinctes ! Les esprits libres ont besoin d'espace pour se sentir bien. Le style loft est synonyme de liberté et de sérénité, mais donne néanmoins le sentiment d'un espace chaleureux grâce à un mobilier et à des accessoires minimalistes. Simple, mais sophistiqué. Des lignes épurées avec des surfaces foncées, contrastées par des touches claires, sont les principales caractéristiques du style loft. Appropriiez-vous son élégance dans votre intérieur avec EGLO.



CHASELY
p. 78



HORNWOOD 2
p. 79



MADRESELVA
p. 80



BOYLE
p. 80-81

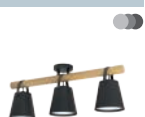

HORNWOOD
p. 82-83

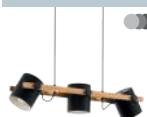

LACEY
p. 84-85

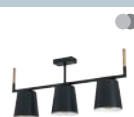

BRAMERTON
p. 86-87



AYLES
p. 87

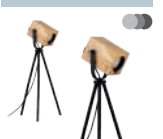

CHIEVELEY p. 88-89	HALKIN p. 90	CONSETT p. 90-91	MONMOUNT p. 92	FAMBOROUGH p. 92-93	NAFFERTON p. 94-95	LITTLETON p. 96-97	IPSDEN p. 98
BASILDON 1 p. 98	BASILDON p. 100-101	CALLOW p. 102	SHERBURN p. 103	TOWNSHEND p. 104-109	TOWNSHEND 5 p. 109-111	PALMORLA p. 112	DISTAFF p. 113
CARLTON 1 p. 114-116, 120-122	CARLTON 7 p. 116-117	CARLTON 4 p. 118	CARLTON 6 p. 118	CARLTON 5 p. 119-120	CARLTON-P p. 122-123	CARLTON p. 125-127	STYPE p. 128-129
STRAITON p. 130-131, 172-173	VERNHAM p. 133	TARBES p. 134, 144-145, 147-151	CARLTON 2 p. 134-135	STILLINGTON p. 136-137	MUMBLES p. 139	SOUTHERY p. 140-141	CASTANUELO p. 142-143
TARBES 2 p. 146	ROCCAMENA p. 152-153	CLEVEDON p. 154	NEWTOWN p. 156-157	AUSTELL p. 158-159	PLIMSOLL p. 161	HORNWOOD 1 p. 162-163	GLASTONBURY p. 164
BIDFORD p. 164-165	LANTADA p. 165	CHESTER p. 167	CHESTER 1 p. 167	CHESTER-P p. 168	DUNDEE p. 168	COPLEY p. 170-171	CORETTO 2 p. 172
HAPTON p. 173	WRINGTON p. 174-175	WRINGTON 1 p. 176-177	POMPEYA p. 178-179	BAZELY p. 181	SALLICANO p. 181	TWICKEN p. 182-183	MATLOCK p. 184-187
GIACONECCHIA p. 188-189	PRESTWICK 3 p. 190-191	PRESTWICK p. 192	LYNTON p. 192	FRIJOLAS p. 192			



This product is available in different colors and shapes./ Dieser Artikel ist in unterschiedlichen Farben und Formen verfügbar.
Cet article est disponible en différentes couleurs et formes.



43459

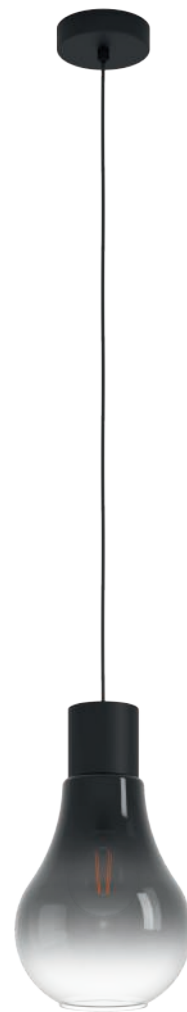

43129

DETAIL CHASELY

The glass shade of this luminaire has a unique color gradient.
 Der Glasschirm dieser Leuchte hat einen einzigartigen Farbverlauf.
 L'abat-jour en verre de cette luminaire a un dégradé de couleurs unique.



43459 CHASELY

pendant light; steel, black / glass, black-brown-transparent
 Hängeleuchte; Stahl, schwarz / Glas, schwarz-braun-transparent
 luminaire en suspension; acier, noir / verre, noir-marron-transparent

H 1100, Ø 200



E27 1x 40W



9 002759 434595



43129 CHASELY

pendant light; steel, black / glass, black-grey-transparent
 Hängeleuchte; Stahl, schwarz / Glas, schwarz-grau-transparent
 luminaire en suspension; acier, noir / verre, noir-gris-transparent

H 1100, Ø 200



E27 1x 40W



9 002759 431297



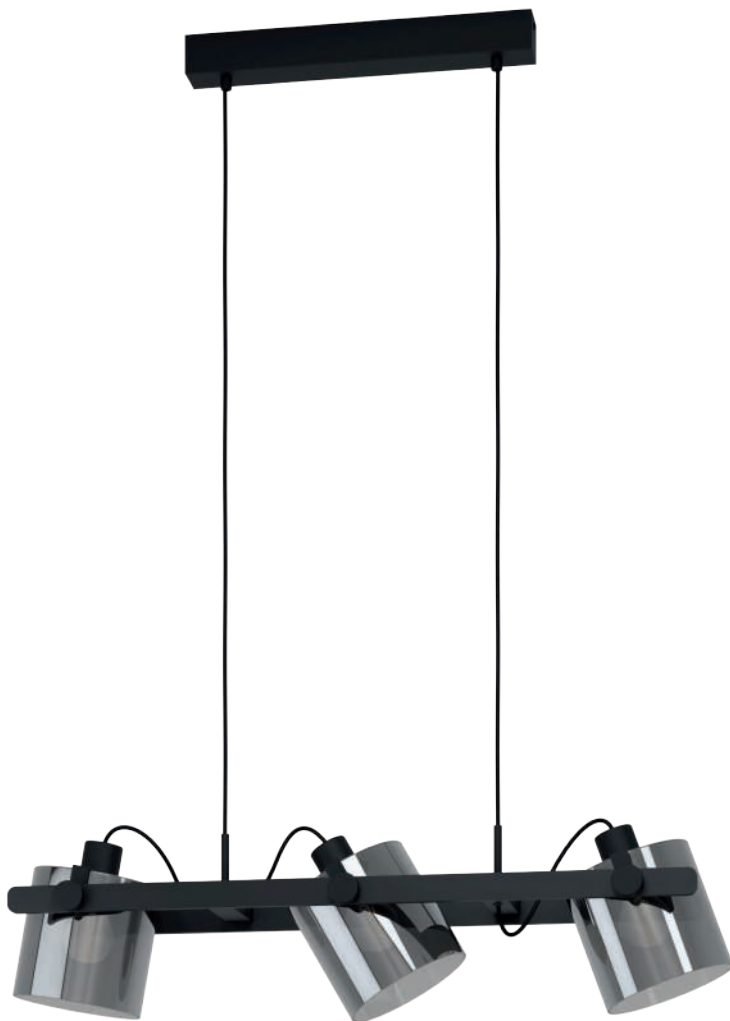

43606



43671



43606 HORNWOOD 2

pendant light; steel, wood, black / glass vaporized, black-transparent

Hängeleuchte; Stahl, Holz, schwarz / Glas bedampft, schwarz-transparent

luminaire en suspension; acier, bois, noir / verre vaporisé, noir transparent

L 780, B 150, H 1100



E27



3x 40W



9 002759 436063

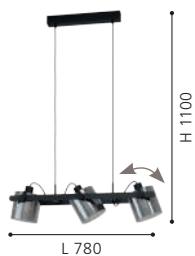

43671 HORNWOOD 2

ceiling light; steel, wood, black / glass vaporized, black-transparent

Deckenleuchte; Stahl, Holz, schwarz / Glas bedampft, schwarz-transparent

plafonnier; acier, bois, noir / verre vaporisé, noir transparent

L 1110, B 225, H 265



E27



4x 40W



9 002759 436711

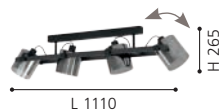

DETAIL HORNWOOD 2

The heads of this luminaire can be swiveled individually.

Die Leuchtenköpfe sind individuell schwenkbar.

Les têtes de ce luminaire peuvent être pivotées individuellement.





43545

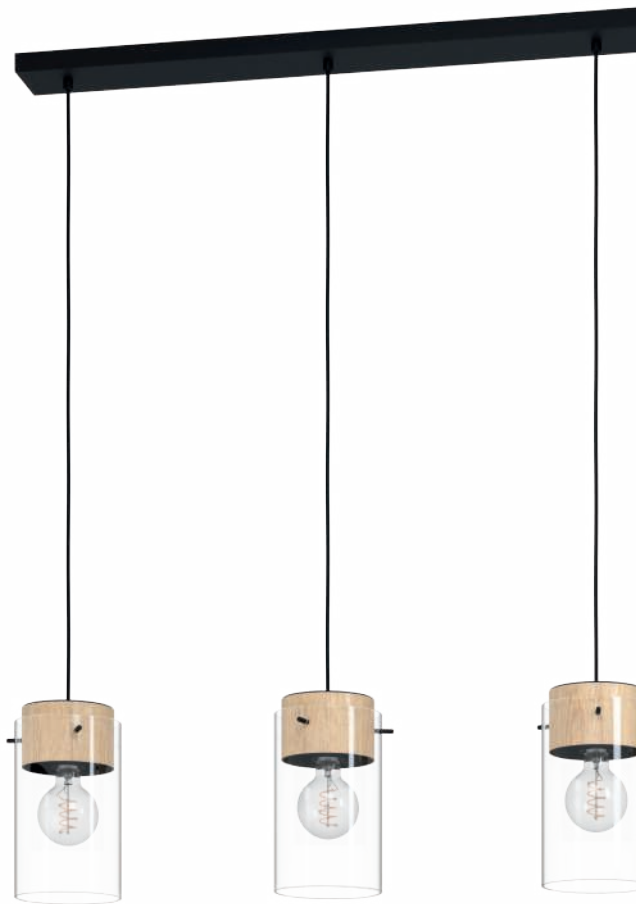

43546



43635



43545 MADRESELVA

pendant light; steel, black / wood, glass, brown, clear
Hängeleuchte; Stahl, schwarz / Holz, Glas, braun, klar
luminaire en suspension; acier, noir / bois, verre, marron, transparent

H 1100, Ø 140



E27 1x 28W



9 002759 435455



43546 MADRESELVA

pendant light; steel, black / wood, glass, brown, clear
Hängeleuchte; Stahl, schwarz / Holz, Glas, braun, klar
luminaire en suspension; acier, noir / bois, verre, marron, transparent

L 1190, B 140, H 1100



E27 3x 28W



9 002759 435462



43635 BOYLE

ceiling light; steel, wood, black, brown / plastic, white
Deckenleuchte; Stahl, Holz, schwarz, braun / Kunststoff, weiss
plafonnier; acier, bois, noir, marron / plastique, blanc

L 780, B 170, H 300



E27 3x 10W



9 002759 436353





43636



43636 BOYLE

pendant light; steel, wood, black, brown / plastic, white
Hängeleuchte; Stahl, Holz, schwarz, braun / Kunststoff, weiss
luminaire en suspension; acier, bois, noir, marron / plastique,
blanc

L 780, B 170, H 1100



E27



3x 10W



9 002759 436360

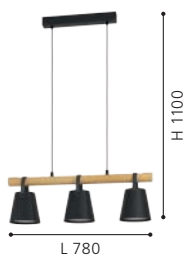



43045



43424



DETAIL HORNWOOD

The heads can be adjusted or fixed in position with the lateral screws.
 Die Köpfe können mittels den seitlichen Schrauben verstellt oder fixiert werden.
 Les têtes peuvent être réglées ou fixées à l'aide des vis latérales.



43046

43045 HORNWOOD

pendant light; steel, black, creme / wood, brown
 Hängeleuchte; Stahl, schwarz, creme / Holz, braun
 luminaire en suspension; acier, noir, crème / bois, marron

L 780, B 210, H 1100



E27 3x 60W



9 002759 430450

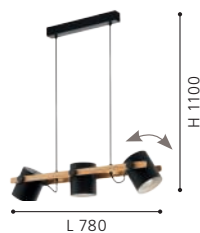

43424 HORNWOOD

pendant light; steel, black, creme / wood, brown
 Hängeleuchte; Stahl, schwarz, creme / Holz, braun
 luminaire en suspension; acier, noir, crème / bois, marron

L 1100, B 180, H 1100



E27 4x 28W



9 002759 434243

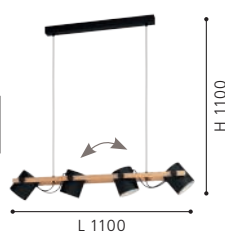

43046 HORNWOOD

wall light; steel, black, creme / wood, brown
 Wandleuchte; Stahl, schwarz, creme / Holz, braun
 applique; acier, noir, crème / bois, marron

Ø 170



E27 1x 28W



9 002759 430467





43558



43047



43048

43558 HORNWOOD

ceiling light; steel, black, creme / wood, brown
Deckenleuchte; Stahl, schwarz, creme / Holz, braun
plafonnier; acier, noir, crème / bois, marron

L 1000, B 190, H 275



E27

4x 28W



9 002759 435585

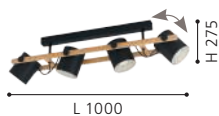

43047 HORNWOOD

table light; steel, black, creme / wood, brown
Tischleuchte; Stahl, schwarz, creme / Holz, braun
luminaire de table; acier, noir, crème / bois, marron

L 210, B 180, H 420, Base: Ø 180



E27

1x 28W



9 002759 430474



43048 HORNWOOD

floor light; steel, black, creme / wood, brown
Stehleuchte; Stahl, schwarz, creme / Holz, braun
lampadaire; acier, noir, crème / bois, marron

L 230, B 230, H 1400, Base: Ø 230



E27

1x 28W



9 002759 430481





43612



43611



DETAIL LACEY

This luminaire has design elements made of real wood.

Diese Leuchte verfügt über Design-elemente aus Echtholz.

Cette luminaire a des éléments de design en bois véritable.

43612 LACEY

pendant light; steel, wood, black, brown / steel, black, creme
Hängeleuchte; Stahl, Holz, schwarz, braun / Stahl, schwarz, creme

luminaire en suspension; acier, bois, noir, marron / acier, noir, crème

L 780, B 160, H 1100



E27



3x 40W



9 002759 436124

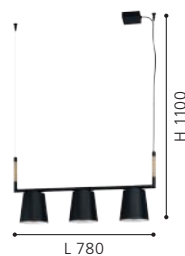

43611 LACEY

ceiling light; steel, wood, black, brown / steel, black, creme
Deckenleuchte; Stahl, Holz, schwarz, braun / Stahl, schwarz, creme

plafonnier; acier, bois, noir, marron / acier, noir, crème

L 780, B 160, H 335



E27



3x 40W



9 002759 436117





43735



43613



43614



43735 LACEY

wall light; steel, wood, black, brown / steel, black, creme
Wandleuchte; Stahl, Holz, schwarz, braun / Stahl, schwarz, creme
applique; acier, bois, noir, marron / acier, noir, crème

L 135, H 275, A 265



E14



1x 40W



9 002759 437350



43613 LACEY

table light; steel, wood, black, brown / steel, black, creme
Tischleuchte; Stahl, Holz, schwarz, braun / Stahl, schwarz, creme
luminaire de table; acier, bois, noir, marron / acier, noir, crème

L 255, B 135, H 485, Base: B 170, T 120



E14



1x 40W



9 002759 436131



43614 LACEY

floor light; steel, wood, black, brown / steel, black, creme
Stehleuchte; Stahl, Holz, schwarz, braun / Stahl, schwarz, creme
lampadaire; acier, bois, noir, marron / acier, noir, crème

L 310, B 160, H 1595, Base: B 280, T 200



E27



1x 40W



9 002759 436148



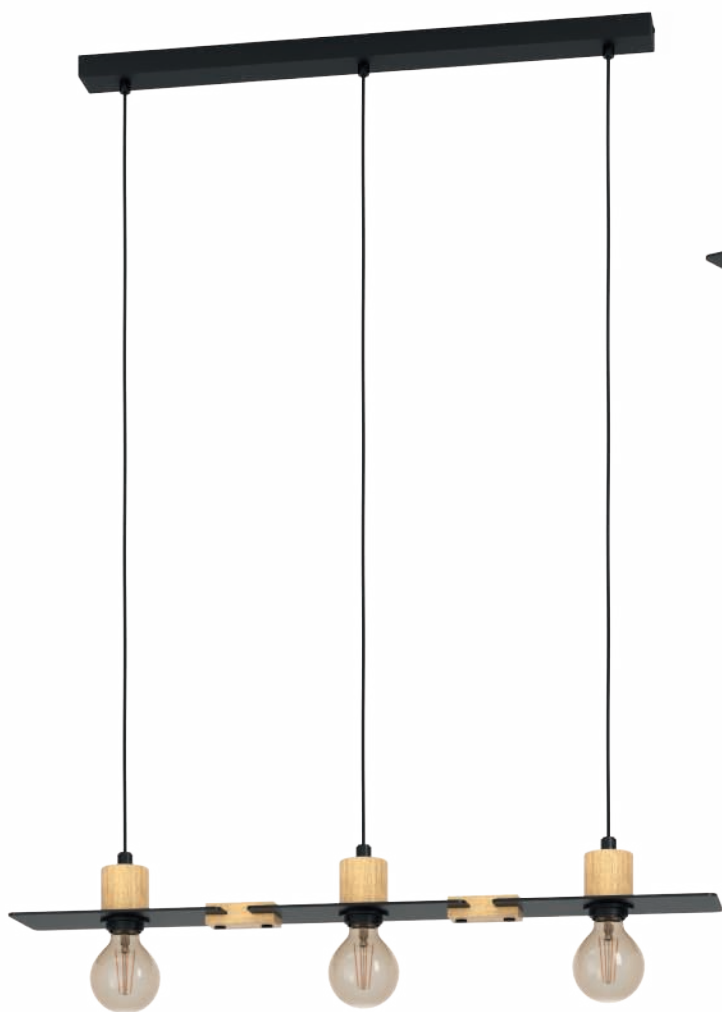

43752



43751



43753



43752 BRAMERTON

pendant light; steel, wood, black, brown
 Hängeleuchte; Stahl, Holz, schwarz, braun
 luminaire en suspension; acier, bois, noir, marron

L 810, B 120, H 1100



E27



3x 40W



9 002759 437527

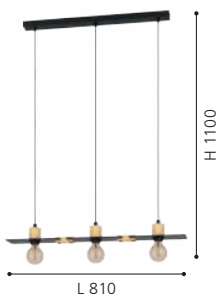

43751 BRAMERTON

ceiling light; steel, wood, black, brown
 Deckenleuchte; Stahl, Holz, schwarz, braun
 plafonnier; acier, bois, noir, marron

L 810, B 120, H 100



E27



3x 40W



9 002759 437510



43753 BRAMERTON

wall light; steel, wood, black, brown
 Wandleuchte; Stahl, Holz, schwarz, braun
 applique; acier, bois, noir, marron

L 120, H 110, A 215



E27



1x 40W



9 002759 437534

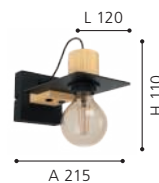



43754



43749



43748



43754 BRAMERTON

table light; steel, wood, black, brown
Tischleuchte; Stahl, Holz, schwarz, braun
luminaire de table; acier, bois, noir, marron

L 120, B 140, H 310, Base: B 120, T 140



E27



1x 40W



9 002759 437541

43749 AYLES

table light; steel, black / wood, brown
Tischleuchte; Stahl, schwarz / Holz, braun
luminaire de table; acier, noir / bois, marron

H 475, Base: Ø 260



GU10



1x 3W



1x
250lm



9 002759 437497



43748 AYLES

pendant light; steel, black / wood, brown
Hängeleuchte; Stahl, schwarz / Holz, braun
luminaire en suspension; acier, noir / bois, marron

L 930, B 85, H 1100



GU10



4x 3W



4x
250lm

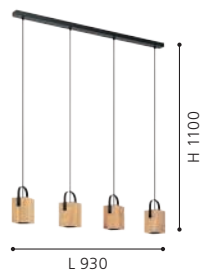

9 002759 437480





43541



43542



43541 CHIEVELEY

pendant light; steel, black / wood, brown
 Hängeleuchte; Stahl, schwarz / Holz, braun
 luminaire en suspension; acier, noir / bois, marron

L 885, B 85, H 1100



E27



5x 40W



9 002759 435417

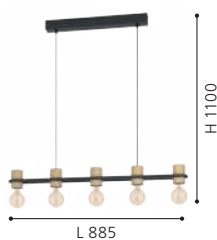

43542 CHIEVELEY

wall light; steel, black / wood, brown
 Wandleuchte; Stahl, schwarz / Holz, braun
 applique; acier, noir / bois, marron

L 285, H 90, A 115



E27



2x 40W



9 002759 435424

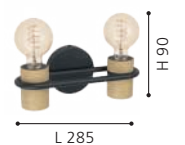



43543

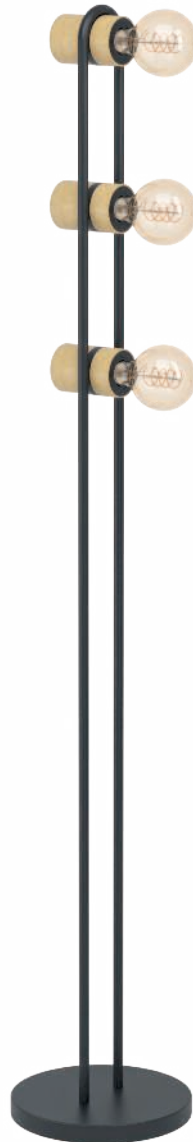

43544



43543 CHIEVELEY

table light; steel, black / wood, brown
Tischleuchte; Stahl, schwarz / Holz, braun
luminaire de table; acier, noir / bois, marron

L 85, B 90, H 410, Base: Ø 155



E27



1x 28 W



9 002759 435431

43544 CHIEVELEY

floor light; steel, black / wood, brown
Stehleuchte; Stahl, schwarz / Holz, braun
lampadaire; acier, noir / bois, marron

L 85, B 90, H 1405, Base: Ø 230



E27



3x 28 W



9 002759 435448



43799



43798



43724



43799 HALKIN

pendant light; wood, steel, brown, black
Hängeleuchte; Holz, Stahl, braun, schwarz
luminaire en suspension; bois, acier, marron, noir

L 720, B 250, H 1100



E27 4x 40W



9 002759 437992

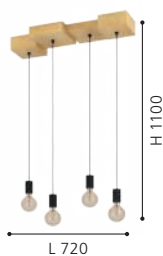

43798 HALKIN

ceiling light; wood, steel, brown, black
Deckenleuchte; Holz, Stahl, braun, schwarz
plafonnier; bois, acier, marron, noir

L 400, B 430, H 140



E27 4x 40W



9 002759 437985

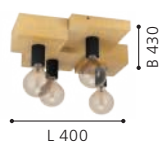

43724 CONSETT

ceiling light; steel, wood, black, brown
Deckenleuchte; Stahl, Holz, schwarz, braun
plafonnier; acier, bois, noir, marron

L 780, B 250, H 115



E27 6x 40W



9 002759 437244

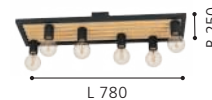



43725



43725 CONSETT

pendant light; steel, wood, black, brown
Hängeleuchte; Stahl, Holz, schwarz, braun
luminaire en suspension; acier, bois, noir, marron

L 780, B 250, H 1100



E27



6x 40W



9 002759 437251

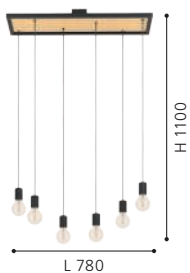

H 1100

L 780

DESIGN
HIGHLIGHT
DETAIL



43641

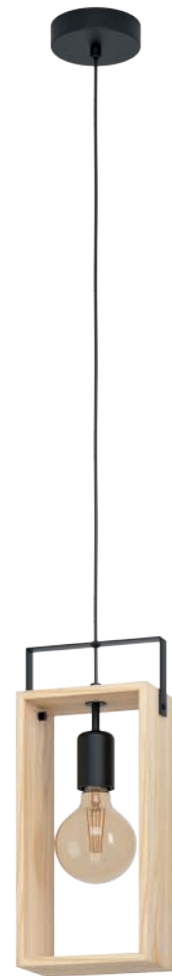

43413



43641 MONMOUNT

pendant light; steel, wood, black, brown
 Hängeleuchte; Stahl, Holz, schwarz, braun
 luminaire en suspension; acier, bois, noir, marron

L 1085, B 445, H 850



E27



9x 40W



9 002759 436414

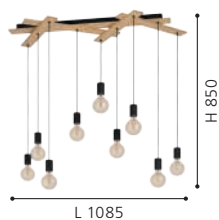

43413 FAMBOROUGH

pendant light; steel, wood, black, natural
 Hängeleuchte; Stahl, Holz, schwarz, natur
 luminaire en suspension; acier, bois, noir, naturel

L 160, B 105, H 1100



E27



1x 40W



9 002759 434137

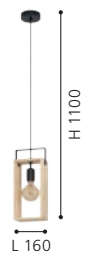



43414



43416



43415



43414 FAMBOROUGH

pendant light; steel, wood, black, natural
Hängeleuchte; Stahl, Holz, schwarz, natur
luminaire en suspension; acier, bois, noir, naturel

L 1000, B 160, H 1100



E27

5x 40W



9 002759 434144

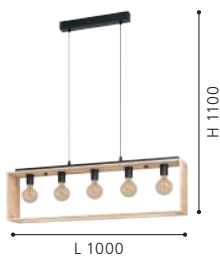

43416 FAMBOROUGH

table light; steel, wood, black, natural
Tischleuchte; Stahl, Holz, schwarz, natur
luminaire de table; acier, bois, noir, naturel

L 305, B 160, H 565, Base: B 300, T 160



E27

3x 40W



9 002759 434168



43415 FAMBOROUGH

table light; steel, wood, black, natural
Tischleuchte; Stahl, Holz, schwarz, natur
luminaire de table; acier, bois, noir, naturel

L 165, B 100, H 400, Base: B 160, T 100



E27

1x 40W



9 002759 434151





43744



43744 NAFFERTON

pendant light; steel, wood, black, brown
Hängeleuchte; Stahl, Holz, schwarz, braun
luminaire en suspension; acier, bois, noir, marron

L 800, B 100, H 1100



E27



3x 40W



9 002759 437442





43743



43746



43745



43743 NAFFERTON

pendant light; steel, wood, black, brown
Hängeleuchte; Stahl, Holz, schwarz, braun
luminaire en suspension; acier, bois, noir, marron

L 100, B 100, H 1100



E27



1x 40W



9 002759 437435



43746 NAFFERTON

table light; steel, wood, black, brown
Tischleuchte; Stahl, Holz, schwarz, braun
luminaire de table; acier, bois, noir, marron

L 100, B 100, H 280



E27



1x 40W



9 002759 437466



43745 NAFFERTON

wall light; steel, wood, black, brown
Wandleuchte; Stahl, Holz, schwarz, braun
applique; acier, bois, noir, marron

L 100, H 280, A 125



E27



1x 40W



9 002759 437459

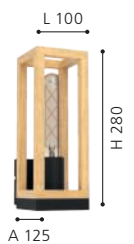



49473



49475

49473 LITTLETON

pendant light; steel, black / wood, brown
Hängeleuchte; Stahl, schwarz / Holz, braun
luminaire en suspension; acier, noir / bois, marron

L 110, B 100, H 1100



E27



1x 60W



9 002759 494735

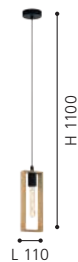

49475 LITTLETON

pendant light; steel, black / wood, brown
Hängeleuchte; Stahl, schwarz / Holz, braun
luminaire en suspension; acier, noir / bois, marron

L 1160, B 55, H 1100



E27



4x 60W



9 002759 494759





49698



49549

49698 LITTLETON

wall light; steel, black / wood, brown
Wandleuchte; Stahl, schwarz / Holz, braun
applique; acier, noir / bois, marron

L 110, H 330, A 115



E27



1x 60W



9 002759 496982



49549 LITTLETON

pendant light; steel, black / wood, brown
Hängeleuchte; Stahl, schwarz / Holz, braun
luminaire en suspension; acier, noir / bois, marron

H 1500, Ø 500



E27



6x 60W



9 002759 495497

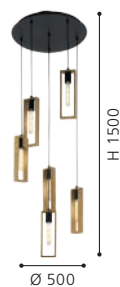



43551



43569



43551 IPSDEN

pendant light; steel, black / wood, brown
 Hängeleuchte; Stahl, schwarz / Holz, braun
 luminaire en suspension; acier, noir / bois, marron

H 1300, Ø 300



E27 3x 40W



9 002759 435516

43569 BASILDON 1

table light; steel, wood, black, brown / fabric, black
 Tischleuchte; Stahl, Holz, schwarz, braun / Textil, schwarz
 luminaire de table; acier, bois, noir, marron / tissu, noir

H 425, Ø 230, Base: Ø 150



E27 1x 40W



9 002759 435691

43552 IPSDEN

pendant light; steel, black / wood, brown
 Hängeleuchte; Stahl, schwarz / Holz, braun
 luminaire en suspension; acier, noir / bois, marron

L 1005, B 220, H 1100



E27 5x 40W

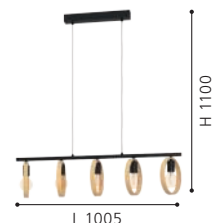

9 002759 435523



43552





DETAIL BASILDON

The black metal ring is individually adjustable.
 Der schwarze Metallring ist individuell verstellbar.
 L'anneau en métal noir est réglable individuellement.



43461



43462



43461 BASILDON

pendant light; steel, wood, black, brown
 Hängeleuchte; Stahl, Holz, schwarz, braun
 luminaire en suspension; acier, bois, noir, marron

L 190, B 160, H 1100



E27 1x 40W



9 002759 434618



43462 BASILDON

pendant light; steel, wood, black, brown
 Hängeleuchte; Stahl, Holz, schwarz, braun
 luminaire en suspension; acier, bois, noir, marron

L 780, B 160, H 1100



E27 3x 40W



9 002759 434625





43736



43464



43463



43736 BASILDON

ceiling light; steel, wood, black, brown
Deckenleuchte; Stahl, Holz, schwarz, braun
plafonnier; acier, bois, noir, marron

H 375, Ø 320



E27



1x 40W



9 002759 437367

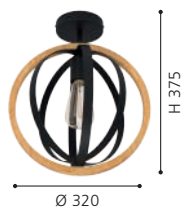

43464 BASILDON

table light; steel, wood, black, brown
Tischleuchte; Stahl, Holz, schwarz, braun
luminaire de table; acier, bois, noir, marron

L 190, B 160, H 345, Base: Ø 155



E27



1x 40W



9 002759 434649



43463 BASILDON

pendant light; steel, wood, black, brown
Hängeleuchte; Stahl, Holz, schwarz, braun
luminaire en suspension; acier, bois, noir, marron

H 1300, Ø 615



E27



3x 40W



9 002759 434632





43756

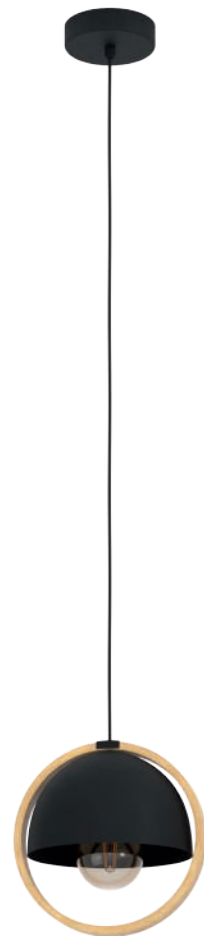

43755



43756 CALLOW

pendant light; steel, wood, black, brown
 Hängeleuchte; Stahl, Holz, schwarz, braun
 luminaire en suspension; acier, bois, noir, marron

L 930, B 230, H 1100



E27



3x 40W



9 002759 437565



43755 CALLOW

pendant light; steel, wood, black, brown
 Hängeleuchte; Stahl, Holz, schwarz, braun
 luminaire en suspension; acier, bois, noir, marron

H 1100, Ø 230



E27



1x 40W



9 002759 437558





43739 SHERBURN

pendant light; steel, wood, black, brown
 Hängeleuchte; Stahl, Holz, schwarz, braun
 luminaire en suspension; acier, bois, noir, marron

L 770, B 200, H 1100



E27



3x 40W



9 002759 437398



43738 SHERBURN

ceiling light; steel, wood, black, brown
 Deckenleuchte; Stahl, Holz, schwarz, braun
 plafonnier; acier, bois, noir, marron

L 800, B 200, H 255



E27



3x 40W



9 002759 437381



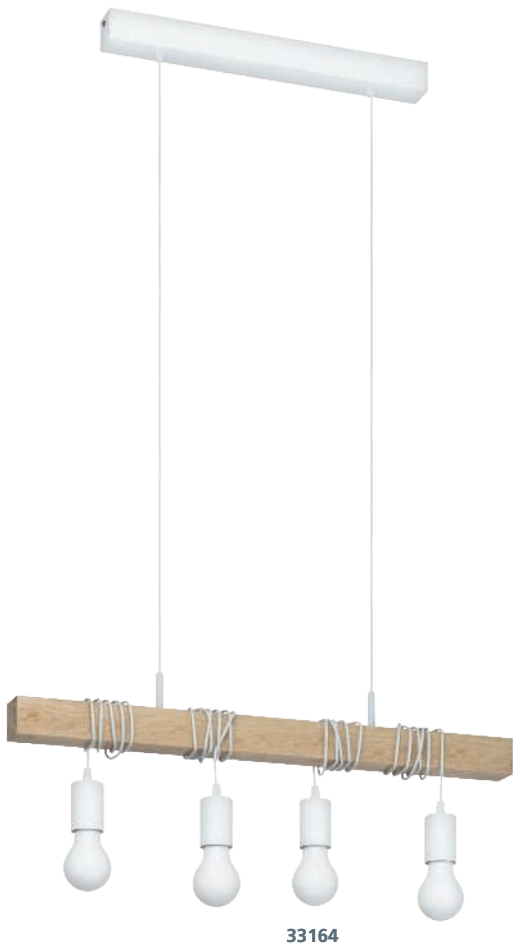

33164



33166



33165

33164 TOWNSHEND

pendant light; steel, white / wood, brown
 Hängeleuchte; Stahl, weiss / Holz, braun
 luminaire en suspension; acier, blanc / bois, marron

L 700, B 105, H 1100



E27 4x 60W



9 002759 331641



33165 TOWNSHEND

pendant light; steel, white / wood, brown
 Hängeleuchte; Stahl, weiss / Holz, braun
 luminaire en suspension; acier, blanc / bois, marron

L 1000, B 100, H 1100



E27 6x 60W



9 002759 331658

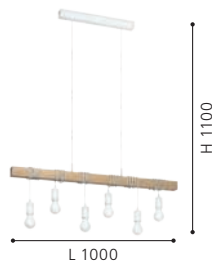

33166 TOWNSHEND

ceiling light; steel, white / wood, brown
 Deckenleuchte; Stahl, weiss / Holz, braun
 plafonnier; acier, blanc / bois, marron

L 550, B 105, H 265



E27 3x 60W



9 002759 331665

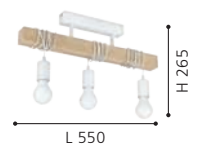



33162



33163



33167

33162 TOWNSHEND

wall light; steel, white / wood, brown
Wandleuchte; Stahl, weiss / Holz, braun
applique; acier, blanc / bois, marron

L 65, H 215, A 185



E27



1x 10W



9 002759 331627



33163 TOWNSHEND

table light; steel, white / wood, brown
Tischleuchte; Stahl, weiss / Holz, braun
luminaire de table; acier, blanc / bois, marron

L 175, B 155, H 500, Base: Ø 155



E27



1x 10W



9 002759 331634



33167 TOWNSHEND

floor light; steel, white / wood, brown
Stehleuchte; Stahl, weiss / Holz, braun
lampadaire; acier, blanc / bois, marron

L 205, B 250, H 1665, Base: Ø 250



E27



2x 10W



9 002759 331672





32916



32915

95499



DETAIL TOWNSHEND

Thanks to the long cable of the luminaire heads, the height can be adjusted individually.

Durch das lange Kabel der Leuchtenköpfe kann die Höhe individuell eingestellt werden.

Grâce au long câble des têtes de luminaire, la hauteur peut être réglée individuellement.

32916 TOWNSHEND

pendant light; steel, wood, black, brown
Hängeleuchte; Stahl, Holz, schwarz, braun
luminaire en suspension; acier, bois, noir, marron

L 700, B 105, H 1100



E27



4x 60W



9 002759 329167

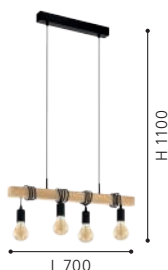

95499 TOWNSHEND

pendant light; steel, wood, black, brown / wood, brown
Hängeleuchte; Stahl, Holz, schwarz, braun / Holz, braun
luminaire en suspension; acier, bois, noir, marron / bois, marron

L 1000, B 100, H 1100



E27



6x 60W



9 002759 954994



32915 TOWNSHEND

ceiling light; steel, wood, black, brown
Deckenleuchte; Stahl, Holz, schwarz, braun
plafonnier; acier, bois, noir, marron

L 550, B 105, H 265



E27



3x 60W



9 002759 329150

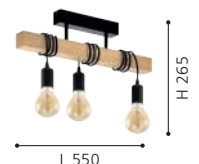



32917



32918



32919

32917 TOWNSHEND

wall light; steel, wood, black, brown
Wandleuchte; Stahl, Holz, schwarz, braun
applique; acier, bois, noir, marron

L 65, H 215, A 190



E27



1x 10W



9 002759 329174



L 65

H 215

A 190

32918 TOWNSHEND

table light; steel, wood, black, brown
Tischleuchte; Stahl, Holz, schwarz, braun
luminaire de table; acier, bois, noir, marron

L 175, B 155, H 500, Base: Ø 155



E27



1x 10W



9 002759 329181



L 175

H 500

Ø 155

32919 TOWNSHEND

floor light; steel, wood, black, brown
Stehleuchte; Stahl, Holz, schwarz, braun
lampadaire; acier, bois, noir, marron

L 205, B 250, H 1665, Base: Ø 250



E27



2x 10W



9 002759 329198



L 205

H 1665

Ø 250



43629



49755

43629 TOWNSHEND

pendant light; steel, wood, black, brown
 Hängeleuchte; Stahl, Holz, schwarz, braun
 luminaire en suspension; acier, bois, noir, marron

L 700, B 390, H 900



E27



5x 60W



9 002759 436292



49755 TOWNSHEND

pendant light; steel, black / wood, black
 Hängeleuchte; Stahl, schwarz / Holz, schwarz
 luminaire en suspension; acier, noir / bois, noir

L 1000, B 100, H 1100



E27



6x 60W



9 002759 497552

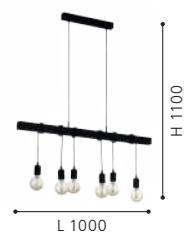



49744

43134

49744 TOWNSHEND

pendant light; wood, steel, brown, black
 Hängeleuchte; Holz, Stahl, braun, schwarz
 luminaire en suspension; bois, acier, marron, noir

L 1500, B 100, H 1100



E27



9x 60W



9 002759 497446

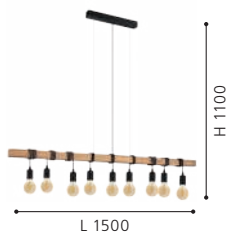

43134 TOWNSHEND 5

pendant light; steel, wood, black, brown
 Hängeleuchte; Stahl, Holz, schwarz, braun
 luminaire en suspension; acier, bois, noir, marron

L 1500, B 200, H 1100



E27



9x 60W



9 002759 431341

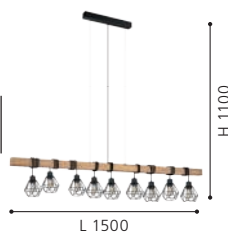



43131



43135



43132

43131 TOWNSHEND 5

ceiling light; steel, wood, black, brown
Deckenleuchte; Stahl, Holz, schwarz, braun
plafonnier; acier, bois, noir, marron

L 550, B 200, H 360



E27 3x 60W



9 002759 431310



43135 TOWNSHEND 5

wall light; steel, wood, black, brown
Wandleuchte; Stahl, Holz, schwarz, braun
applique; acier, bois, noir, marron

L 140, H 245, A 240



E27 1x 60W



9 002759 431358



43132 TOWNSHEND 5

pendant light; steel, wood, black, brown
Hängeleuchte; Stahl, Holz, schwarz, braun
luminaire en suspension; acier, bois, noir, marron

L 700, B 200, H 1100



E27 4x 60W



9 002759 431327





43133



43136

43137

43133 TOWNSHEND 5

pendant light; steel, wood, black, brown
 Hängeleuchte; Stahl, Holz, schwarz, braun
 luminaire en suspension; acier, bois, noir, marron

L 1000, B 200, H 1100



E27



6x 60W



9 002759 431334



43136 TOWNSHEND 5

table light; steel, wood, black, brown
 Tischleuchte; Stahl, Holz, schwarz, braun
 luminaire de table; acier, bois, noir, marron

L 220, B 155, H 500, Base: Ø 155



E27



1x 60W



9 002759 431365



43137 TOWNSHEND 5

floor light; steel, wood, black, brown
 Stehleuchte; Stahl, Holz, schwarz, braun
 lampadaire; acier, bois, noir, marron

L 400, B 250, H 1665, Base: Ø 250



E27



2x 60W



9 002759 431372





43378



43379

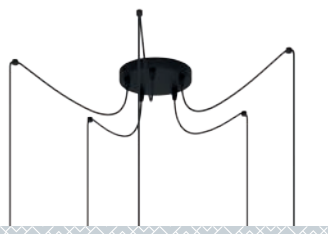

DETAIL 43379

The luminaire heads can be installed on the ceiling individually.
 Die Leuchtenköpfe können individuell an die Decke montiert werden.
 Les têtes de luminaires peuvent être montées individuellement au plafond.

43378 PALMORLA

pendant light; steel, wood, black, brown
 Hängeleuchte; Stahl, Holz, schwarz, braun
 luminaire en suspension; acier, bois, noir, marron

L 760, B 160, H 1100



E27 3x 60W



9 002759 433789



43379 PALMORLA

pendant light; steel, wood, black, brown
 Hängeleuchte; Stahl, Holz, schwarz, braun
 luminaire en suspension; acier, bois, noir, marron

H 1300, Ø 845



E27 5x 60W



9 002759 433796

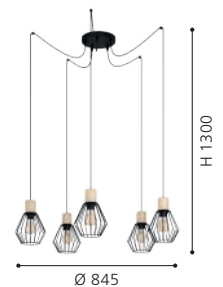



43581



43582

43581 DISTAFF

pendant light; steel, black
Hängeleuchte; Stahl, schwarz
luminaire en suspension; acier, noir

L 900, B 185, H 1100



E27



3x 40W



9 002759 435813



L 900

H 1100

43582 DISTAFF

pendant light; steel, black
Hängeleuchte; Stahl, schwarz
luminaire en suspension; acier, noir

H 1300, Ø 340



E27



3x 40W



9 002759 435820



Ø 340

H 1300



49997



49878

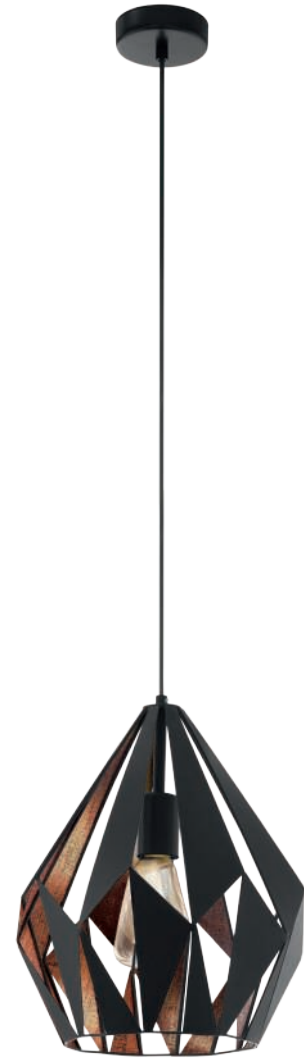

49254

49997 CARLTON 1

pendant light; steel, black, copper
Hängeleuchte; Stahl, schwarz, kupfer
luminaire en suspension; acier, noir, cuivre

H 1100, Ø 205



E27 1x 60W



9 002759 499976

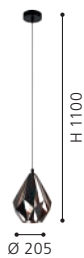

49878 CARLTON 1

pendant light; steel, black, copper
Hängeleuchte; Stahl, schwarz, kupfer
luminaire en suspension; acier, noir, cuivre

H 1500, Ø 385



E27 1x 60W



9 002759 498788



49254 CARLTON 1

pendant light; steel, black, copper
Hängeleuchte; Stahl, schwarz, kupfer
luminaire en suspension; acier, noir, cuivre

H 1100, Ø 310



E27 1x 60W



9 002759 492540





49991



49992



49994

49991 CARLTON 1

pendant light; steel, black, copper
Hängeleuchte; Stahl, schwarz, kupfer
luminaire en suspension; acier, noir, cuivre

L 805, B 205, H 1100



E27



3x 60W



9 002759 499914



L 805

H 1100

49992 CARLTON 1

wall light; steel, black, copper
Wandleuchte; Stahl, schwarz, kupfer
applique; acier, noir, cuivre

L 205, H 330, A 220



E27



1x 60W



9 002759 499921



L 205

H 330

A 220

49994 CARLTON 1

floor light; steel, black, copper
Stehleuchte; Stahl, schwarz, kupfer
lampadaire; acier, noir, cuivre

H 1525, Ø 255, Base: Ø 230



E27



1x 60W



9 002759 499945



Ø 255

H 1525

Ø 230



43846



43716

43846 CARLTON 1

pendant light; steel, black, copper
Hängeleuchte; Stahl, schwarz, kupfer
luminaire en suspension; acier, noir, cuivre

L 1455, B 385, H 1070



E27



6x 40W



9 002759 438463



L 1455

H 1070

43716 CARLTON 7

spot; steel, black, copper color-antique
Spot; Stahl, schwarz, kupferfarben-antik
spot; acier, noir, aspect cuivre-antique

L 420, B 160, H 255



E27



2x 40W



9 002759 437169



L 420

H 255



43717



43718



43715

43717 CARLTON 7

spot; steel, black, copper color-antique
Spot; Stahl, schwarz, kupferfarben-antik
spot; acier, noir, aspect cuivre-antique

L 730, B 160, H 255



E27



3x 40W



9 002759 437176



43715 CARLTON 7

spot; steel, black, copper color-antique
Spot; Stahl, schwarz, kupferfarben-antik
spot; acier, noir, aspect cuivre-antique

Ø 160, A 255



E27



1x 40W



9 002759 437152



43718 CARLTON 7

spot; steel, black, copper color-antique
Spot; Stahl, schwarz, kupferfarben-antik
spot; acier, noir, aspect cuivre-antique

L 370, B 370, H 255



E27



4x 40W



9 002759 437183





43057



43399



43058

43057 CARLTON 4

wall light; steel, black, copper color-antique
Wandleuchte; Stahl, schwarz, kupferfarben-antik
applique; acier, noir, aspect cuivre-antique

L 160, H 315, A 225



E27 1x 60W



9 002759 430573



43058 CARLTON 4

table light; steel, black, copper color-antique
Tischleuchte; Stahl, schwarz, kupferfarben-antik
luminaire de table; acier, noir, aspect cuivre-antique

L 220, B 160, H 505, Base: Ø 170



E27 1x 60W



9 002759 430580

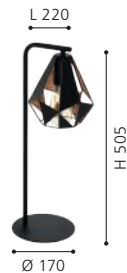

43399 CARLTON 6

ceiling light; steel, black, copper
Deckenleuchte; Stahl, schwarz, kupfer
plafonnier; acier, noir, cuivre

H 235, Ø 470



E27 1x 60W



9 002759 433994

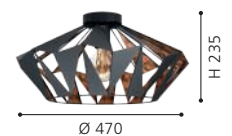



43077

43077 CARLTON 5

table light; steel, black, copper / fabric, black, copper
Tischleuchte; Stahl, schwarz, kupfer / Textil, schwarz, kupfer
luminaire de table; acier, noir, cuivre / tissu, noir, cuivre

H 510, Ø 250



E27



1x 60W



9 002759 430771



49932 CARLTON 1

pendant light; steel, white, honey gold
 Hängeleuchte; Stahl, weiss, honiggold
 luminaire en suspension; acier, blanc, or

H 1100, Ø 310



43002 CARLTON 1

pendant light; steel, white, gold
 Hängeleuchte; Stahl, weiss, gold
 luminaire en suspension; acier, blanc, or

L 805, B 205, H 1100

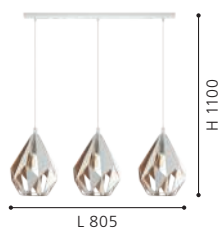

43078 CARLTON 5

table light; steel, white, honey gold / fabric, white
 Tischleuchte; Stahl, weiss, honiggold / Textil, weiss
 luminaire de table; acier, blanc, or / tissu, blanc

H 510, Ø 250

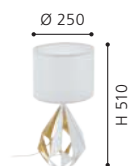



43001

43001 CARLTON 1

pendant light; steel, white, gold
Hängeleuchte; Stahl, weiss, gold
luminaire en suspension; acier, blanc, or

H 1100, Ø 205



E27



1x 60W



9 002759 430016





49255



49931



49026

49255 CARLTON 1

pendant light; steel, black, silver
Hängeleuchte; Stahl, schwarz, silber
luminaire en suspension; acier, noir, argent

H 1100, Ø 310



E27 1x 60W



9 002759 492557



49931 CARLTON 1

pendant light; steel, black, gold
Hängeleuchte; Stahl, schwarz, gold
luminaire en suspension; acier, noir, or

H 1100, Ø 310



E27 1x 60W



9 002759 499310



49026 CARLTON-P

pendant light; steel, pastel light green
Hängeleuchte; Stahl, Pastell hellgrün
luminaire en suspension; acier, pastel vert clair

H 1500, Ø 310



E27 1x 60W



9 002759 490263





49024

49024 CARLTON-P

pendant light; steel, pastel apricot
Hängeleuchte; Stahl, Pastell apricot
luminaire en suspension; acier, Pastel abricot

H 1500, Ø 310



E27



1x 60W



9 1002759 490249





43815



43814



43815 CARLTON

pendant light; steel, gold-coloured
Hängeleuchte; Stahl, goldfarben
luminaire en suspension; acier, or

H 1100, Ø 385



E27



1x 60W



9 002759 438159



43814 CARLTON

pendant light; steel, gold-coloured
Hängeleuchte; Stahl, goldfarben
luminaire en suspension; acier, or

H 1100, Ø 310



E27



1x 60W



9 002759 438142





49257



49258



49259

49257 CARLTON

pendant light; steel, black
Hängeleuchte; Stahl, schwarz
luminaire en suspension; acier, noir

H 1100, Ø 310



E27 1x 60W



9 002759 492571

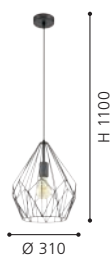

49258 CARLTON

pendant light; steel, copper-coloured
Hängeleuchte; Stahl, kupferfarben
luminaire en suspension; acier, cuivré

H 1100, Ø 310



E27 1x 60W



9 002759 492588



49259 CARLTON

pendant light; steel, mint
Hängeleuchte; Stahl, mint
luminaire en suspension; acier, menthe

H 1100, Ø 310



E27 1x 60W



9 002759 492595





49933



49935

49933 CARLTON

pendant light; steel, gold-coloured
Hängeleuchte; Stahl, goldfarben
luminaire en suspension; acier, or

H 1100, Ø 310



E27



1x 60W



9 002759 499334

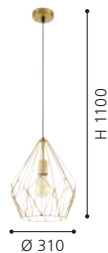

49935 CARLTON

pendant light; steel, silver
Hängeleuchte; Stahl, silber
luminaire en suspension; acier, argent

H 1100, Ø 310



E27



1x 60W



9 002759 499358





43695

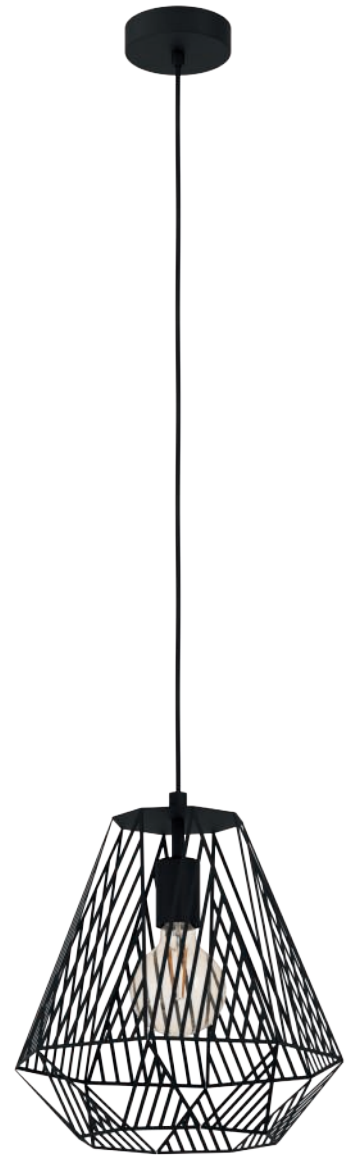

43692

43695 STYPE

pendant light; steel, gold-coloured
Hängeleuchte; Stahl, goldfarben
luminaire en suspension; acier, or

H 1100, Ø 330



E27



1x 40W



9 002759 436957



43692 STYPE

pendant light; steel, black
Hängeleuchte; Stahl, schwarz
luminaire en suspension; acier, noir

H 1100, Ø 330



E27



1x 40W



9 002759 436926





43696



43693

43696 STYPE

pendant light; steel, gold-coloured
Hängeleuchte; Stahl, goldfarben
luminaire en suspension; acier, or

L 960, B 200, H 1100



E27



3x 40W



9 002759 436964



43693 STYPE

pendant light; steel, black
Hängeleuchte; Stahl, schwarz
luminaire en suspension; acier, noir

L 960, B 200, H 1100



E27



3x 40W



9 002759 436933





43359



43361

43359 STRAITON

pendant light; steel, black
 Hängeleuchte; Stahl, schwarz
 luminaire en suspension; acier, noir

H 1100, Ø 515



E27 1x 60W



9 002759 433598

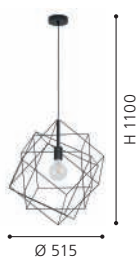

43361 STRAITON

pendant light; steel, black
 Hängeleuchte; Stahl, schwarz
 luminaire en suspension; acier, noir

L 905, B 240, H 1100



E27 3x 60W



9 002759 433611



43366 STRAITON

pendant light; steel, black
 Hängeleuchte; Stahl, schwarz
 luminaire en suspension; acier, noir

H 1100, Ø 645



E27 3x 60W



9 002759 433666

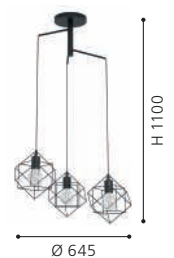



43366



43358

43358 STRAITON

pendant light; steel, black
 Hängeleuchte; Stahl, schwarz
 luminaire en suspension; acier, noir

L 240, B 205, H 1100



E27



1x 60W



9 002759 433581





43481



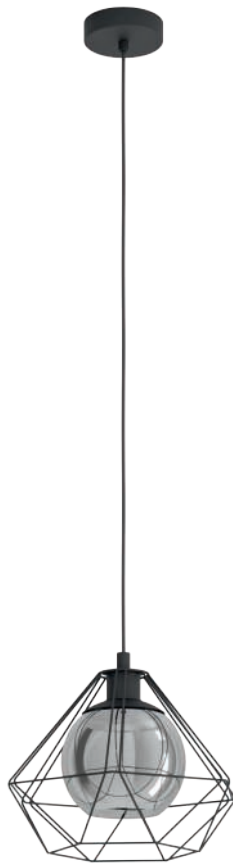

43482



43483

43481 VERNHAM

pendant light; steel, black / glass vaporized, black-transparent
 Hängeleuchte; Stahl, schwarz / Glas bedampft, schwarz-transparent
 luminaire en suspension; acier, noir / verre vaporisé, noir transparent

H 1100, Ø 445



E27



1x 40W



9 002759 434816

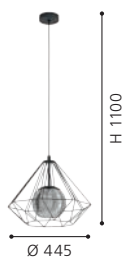

43482 VERNHAM

pendant light; steel, black / glass vaporized, black-transparent
 Hängeleuchte; Stahl, schwarz / Glas bedampft, schwarz-transparent
 luminaire en suspension; acier, noir / verre vaporisé, noir transparent

H 1100, Ø 325



E27



1x 40W



9 002759 434823



43483 VERNHAM

pendant light; steel, black / glass vaporized, black-transparent
 Hängeleuchte; Stahl, schwarz / Glas bedampft, schwarz-transparent
 luminaire en suspension; acier, noir / verre vaporisé, noir transparent

L 1145, B 325, H 1100



E27



3x 40W



9 002759 434830

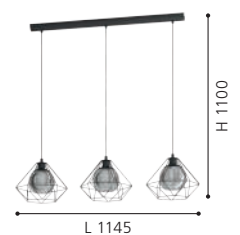



43004



49081

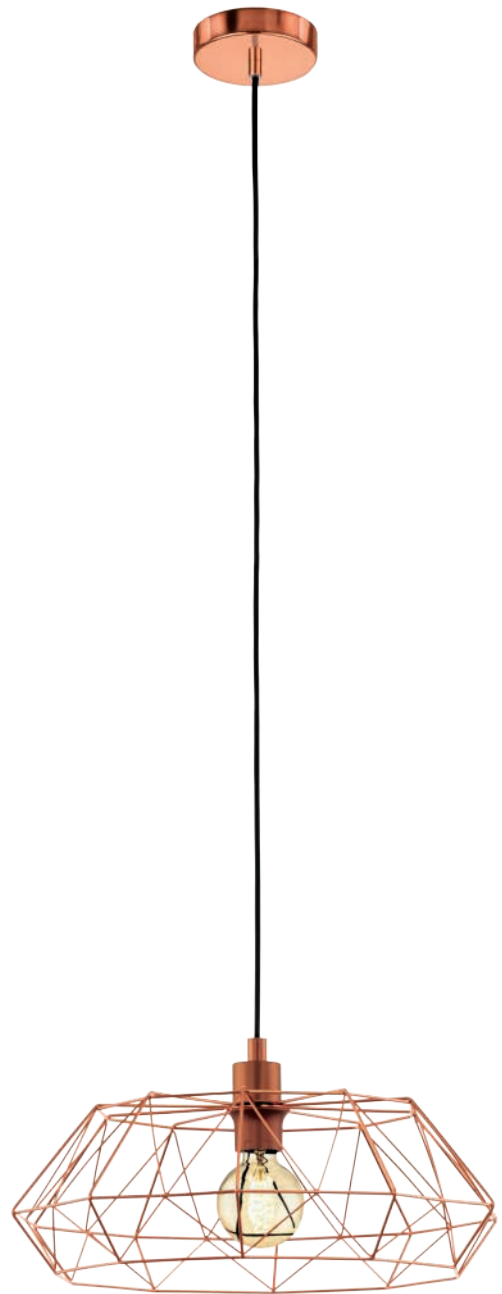

49488

43004 TARDES

ceiling light; steel, black
Deckenleuchte; Stahl, schwarz
plafonnier; acier, noir

H 275, Ø 325



E27 1x 60W



9 002759 430047



49081 TARDES

wall light; steel, black
Wandleuchte; Stahl, schwarz
applique; acier, noir

L 155, H 375, A 275



E27 1x 60W



9 002759 490812



49488 CARLTON 2

pendant light; steel, copper
Hängeleuchte; Stahl, kupfer
luminaire en suspension; acier, cuivre

H 1100, Ø 455



E27 1x 60W



9 002759 494889

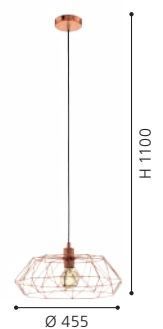



49487

49487 CARLTON 2

pendant light; steel, black
Hängeleuchte; Stahl, schwarz
luminaire en suspension; acier, noir

H 1100, Ø 455



E27



1x 60W



9 002759 494872

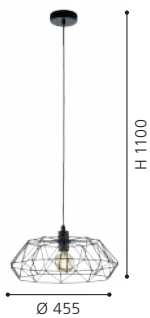



43766



43767

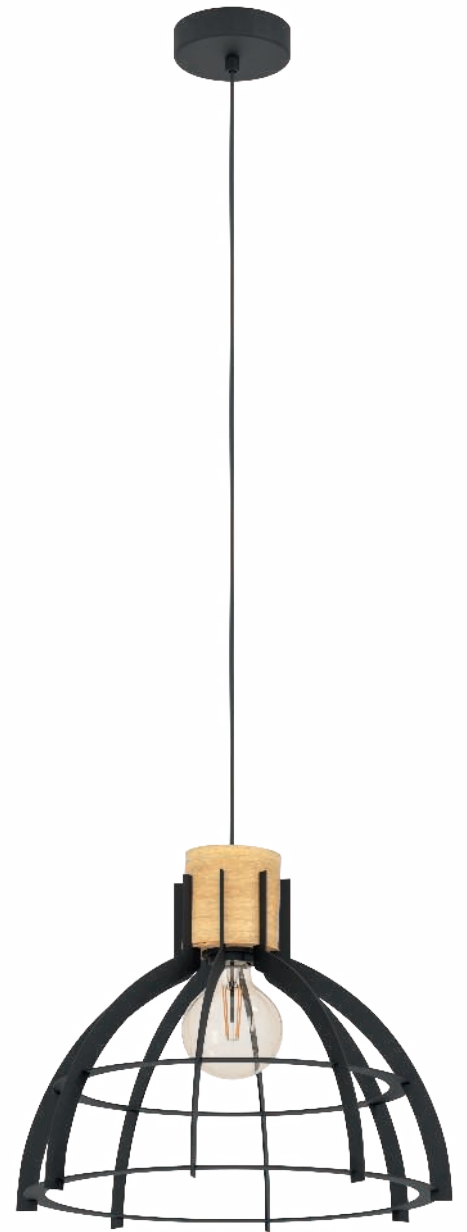

43769

43766 STILLINGTON

ceiling light; steel, black, gold
Deckenleuchte; Stahl, schwarz, gold
plafonnier; acier, noir, or

H 315, Ø 415



E27 1x 40W



9 002759 437664



43767 STILLINGTON

pendant light; steel, black, gold
Hängeleuchte; Stahl, schwarz, gold
luminaire en suspension; acier, noir, or

H 1100, Ø 415



E27 1x 40W



9 002759 437671



43769 STILLINGTON

pendant light; steel, wood, black, brown
Hängeleuchte; Stahl, Holz, schwarz, braun
luminaire en suspension; acier, bois, noir, marron

H 1100, Ø 415



E27 1x 40W



9 002759 437695





43768

43768 STILLINGTON

ceiling light; steel, wood, black, brown
Deckenleuchte; Stahl, Holz, schwarz, braun
plafonnier; acier, bois, noir, marron

H 315, Ø 415



E27



1x 40W



9 002759 437688





43813

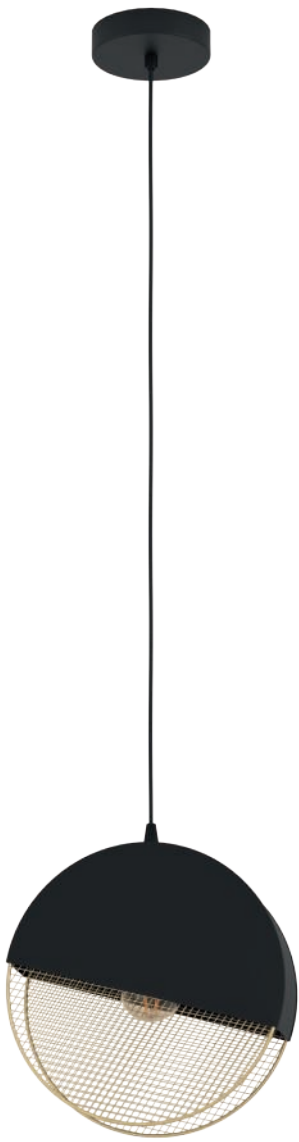

43811

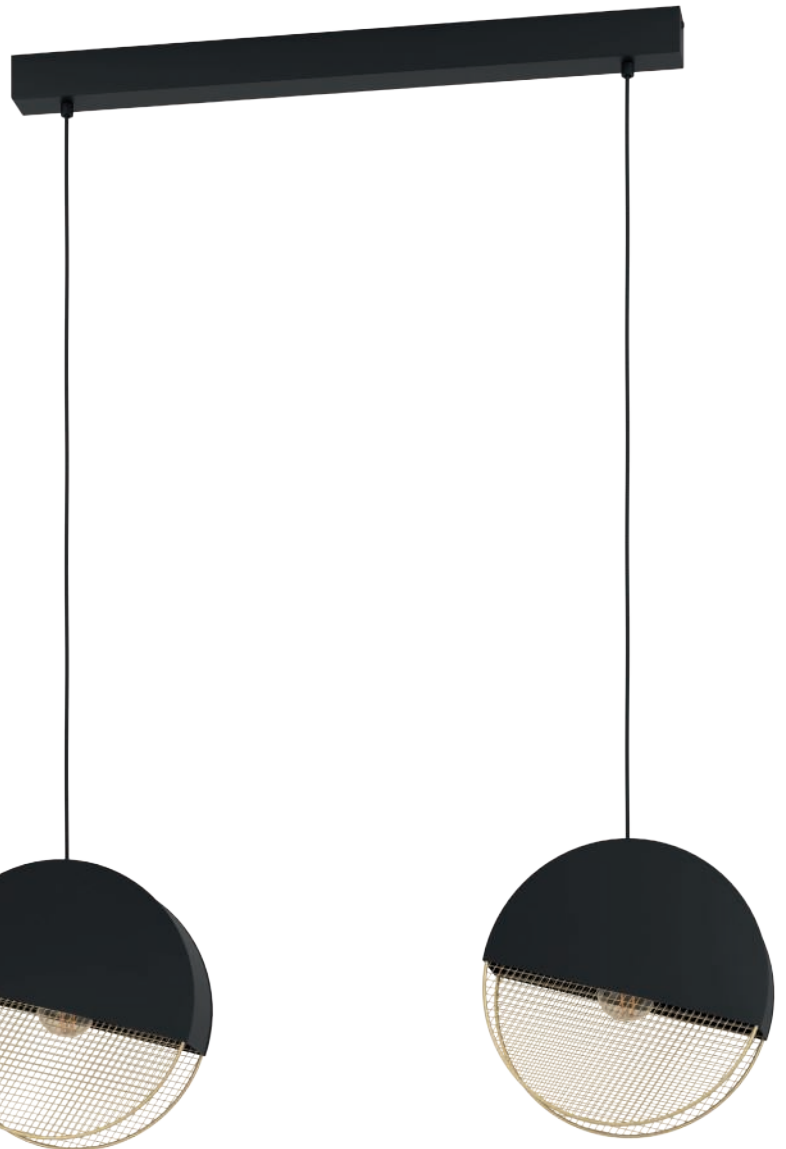

43812

43813 MUMBLES

table light; steel, black, gold
Tischleuchte; Stahl, schwarz, gold
luminaire de table; acier, noir, or

L 280, B 90, H 285, Base: Ø 170



E27 1x 40W



9 002759 438135



43811 MUMBLES

pendant light; steel, black, gold
Hängeleuchte; Stahl, schwarz, gold
luminaire en suspension; acier, noir, or

L 285, B 90, H 1100



E27 1x 40W



9 002759 438111

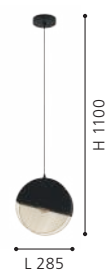

43812 MUMBLES

pendant light; steel, black, gold
Hängeleuchte; Stahl, schwarz, gold
luminaire en suspension; acier, noir, or

L 860, B 90, H 1100



E27 2x 40W



9 002759 438128

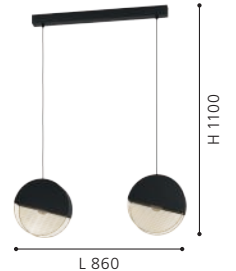

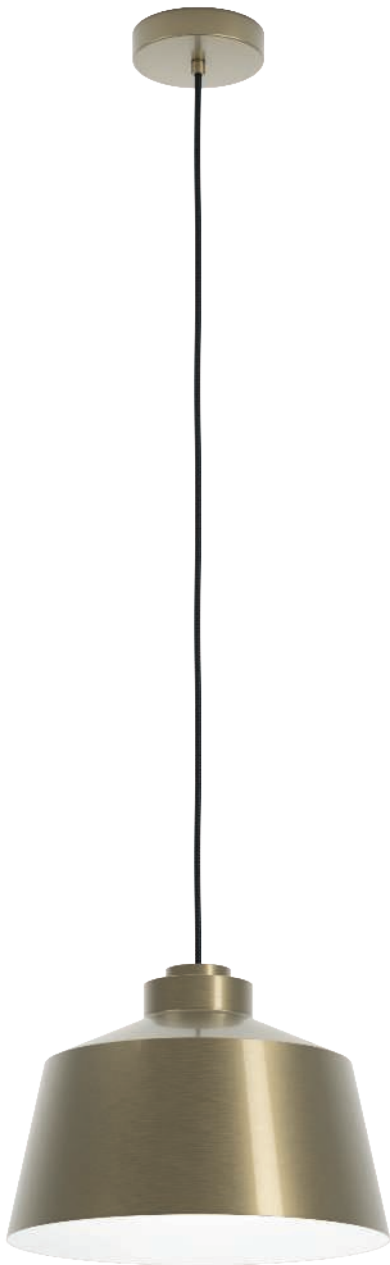

43816



43818



43817

43816 SOUTHERY

pendant light; steel, creme-gold brushed, white
Hängeleuchte; Stahl, creme-gold gebürstet, weiss
luminaire en suspension; acier, or crème brossé, blanc

H 1100, Ø 350



E27 1x 40W



9 002759 438166

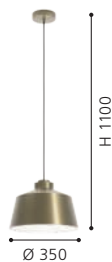

43817 SOUTHERY

spot; steel, creme-gold brushed, white
Spot; Stahl, creme-gold gebürstet, weiss
spot; acier, or crème brossé, blanc

L 185, B 110, H 210



E27 1x 40W



9 002759 438173



43818 SOUTHERY

spot; steel, creme-gold brushed, white
Spot; Stahl, creme-gold gebürstet, weiss
spot; acier, or crème brossé, blanc

L 470, B 110, H 210



E27 2x 40W



9 002759 438180





43819

43819 SOUTHERY

spot; steel, creme-gold brushed, white
Spot; Stahl, creme-gold gebürstet, weiss
spot; acier, or crème brossé, blanc

L 700, B 110, H 210



E27



3x 40W



9 002759 438197





43443



DETAIL 43599

This ceiling luminaire has a great play of light.

Diese Deckenleuchte verfügt über ein tolles Lichtspiel.

Ce plafonnier a un grand jeu de lumière.

43443 CASTANUELO

wall / ceiling light; steel, gold-coloured
Wand- / Deckenleuchte; Stahl, goldfarben
applique / plafonnier; acier, or

H 105, Ø 425



E27



1x 40W



9 002759 434434

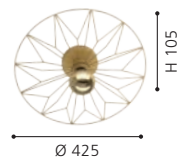



43599



43808



43809

43599 CASTANUELO

wall / ceiling light; steel, gold-coloured
Wand- / Deckenleuchte; Stahl, goldfarben
applique / plafonnier; acier, or

H 100, Ø 425



E27



1x 40W



9 002759 435998



H 100

Ø 425

43808 CASTANUELO

table light; steel, black, gold
Tischleuchte; Stahl, schwarz, gold
luminaire de table; acier, noir, or

L 370, B 270, H 575, Base: Ø 295



E27



1x 40W



9 002759 438081



L 370

H 575

Ø 295

43809 CASTANUELO

floor light; steel, black, gold
Stehleuchte; Stahl, schwarz, gold
lampadaire; acier, noir, or

L 500, B 270, H 1520, Base: Ø 745



E27



1x 40W



9 002759 438098

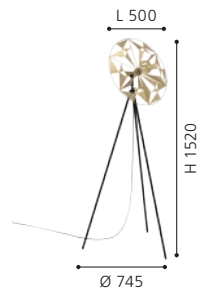

L 500

H 1520

Ø 745



43679



43681

43679 TARDES

pendant light; steel, brushed brass
 Hängeleuchte; Stahl, messing-gebürstet
 luminaire en suspension; acier, laiton brossé

H 1100, Ø 325



E27 1x 60W



9 002759 436797



43681 TARDES

pendant light; steel, brushed brass
 Hängeleuchte; Stahl, messing-gebürstet
 luminaire en suspension; acier, laiton brossé

H 1300, Ø 175



E27 1x 60W



9 002759 436810





43682



43683

43682 TARBES

pendant light; steel, brushed brass
 Hängeleuchte; Stahl, messing-gebürstet
 luminaire en suspension; acier, laiton brossé

L 795, B 175, H 1300



E27



3x 60W



9 002759 436827



L 795

H 1300

43683 TARBES

pendant light; steel, brushed brass
 Hängeleuchte; Stahl, messing-gebürstet
 luminaire en suspension; acier, laiton brossé

H 1300, Ø 355



E27



3x 60W



9 002759 436834



Ø 355

H 1300



43654



43655

43654 TARBES 2

ceiling light; steel, black, brass
 Deckenleuchte; Stahl, schwarz, messing
 plafonnier; acier, noir, laiton

H 245, Ø 450



E27



3x 40W



9 002759 436544



Ø 450

H 245

43655 TARBES 2

ceiling light; steel, black, brass
 Deckenleuchte; Stahl, schwarz, messing
 plafonnier; acier, noir, laiton

L 770, B 175, H 245



E27



3x 40W



9 002759 436551



L 770

H 245



43678



43684

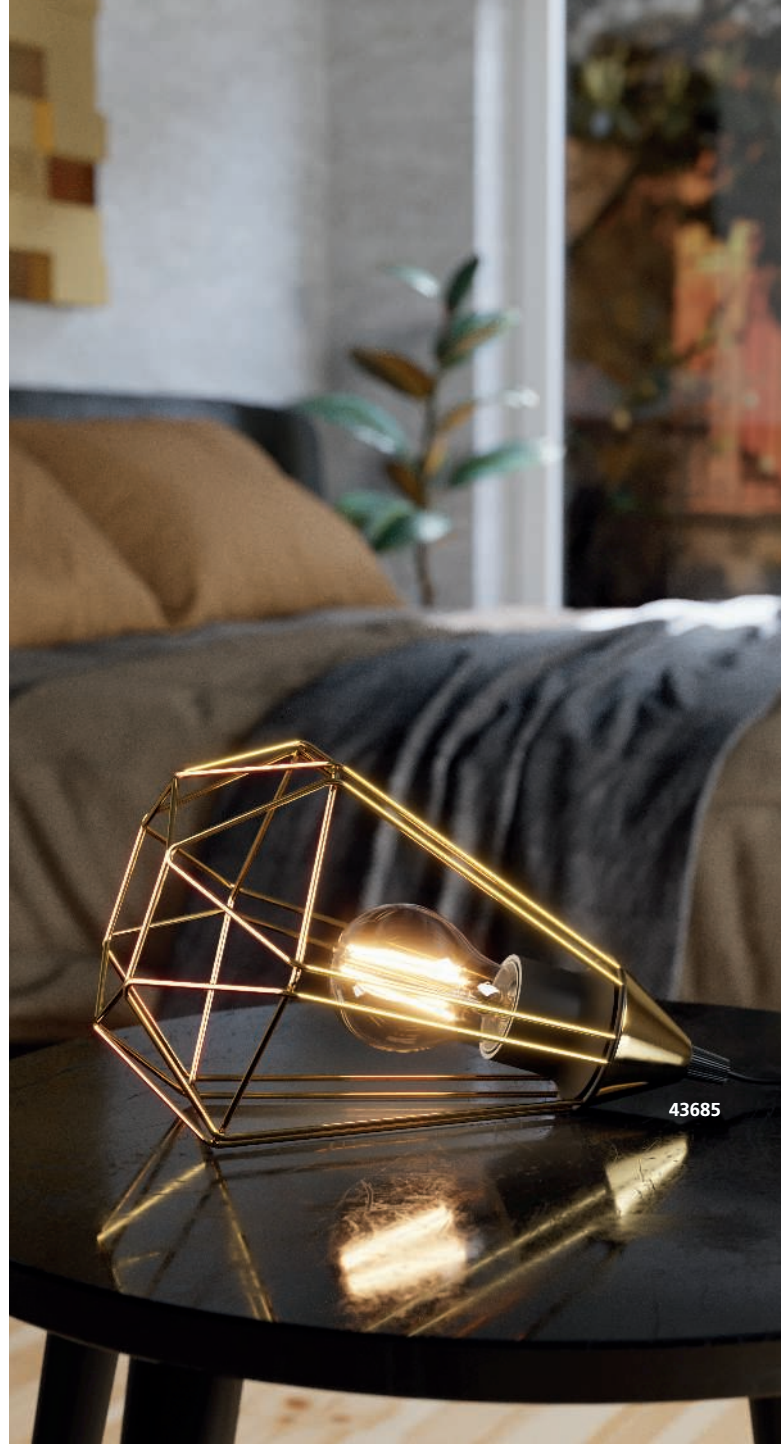

43685

43678 TARDES

ceiling light; steel, brushed brass
Deckenleuchte; Stahl, messing-gebürstet
plafonnier; acier, laiton brossé

H 275, Ø 325



E27



1x 60W



9 002759 436780

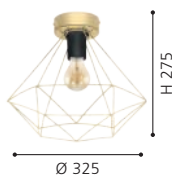

43684 TARDES

wall light; steel, brushed brass
Wandleuchte; Stahl, messing-gebürstet
applique; acier, laiton brossé

L 155, H 345, A 275



E27



1x 60W



9 002759 436841



43685 TARDES

table light; steel, brushed brass
Tischleuchte; Stahl, messing-gebürstet
luminaire de table; acier, laiton brossé

H 265, Ø 175



E27



1x 60W



9 002759 436858

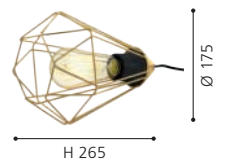

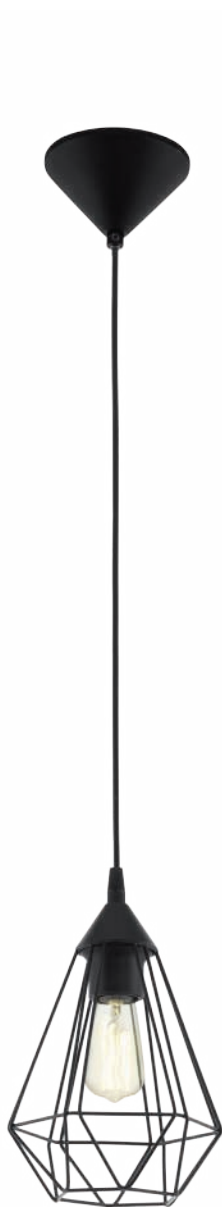

94187



94188



94191

94187 TARBES

pendant light; plastic, black / steel, black
Hängeleuchte; Kunststoff, schwarz / Stahl, schwarz
luminaire en suspension; plastique, noir / acier, noir

H 1100, Ø 175



E27 1x 60W



9 002759 941871



94188 TARBES

pendant light; plastic, black / steel, black
Hängeleuchte; Kunststoff, schwarz / Stahl, schwarz
luminaire en suspension; plastique, noir / acier, noir

H 1100, Ø 325



E27 1x 60W



9 002759 941888



94191 TARBES

pendant light; steel, black / steel, black
Hängeleuchte; Stahl, schwarz / Stahl, schwarz
luminaire en suspension; acier, noir / acier, noir

H 1100, Ø 310



E27 3x 60W



9 002759 941918

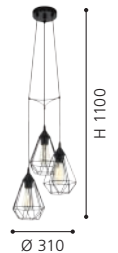

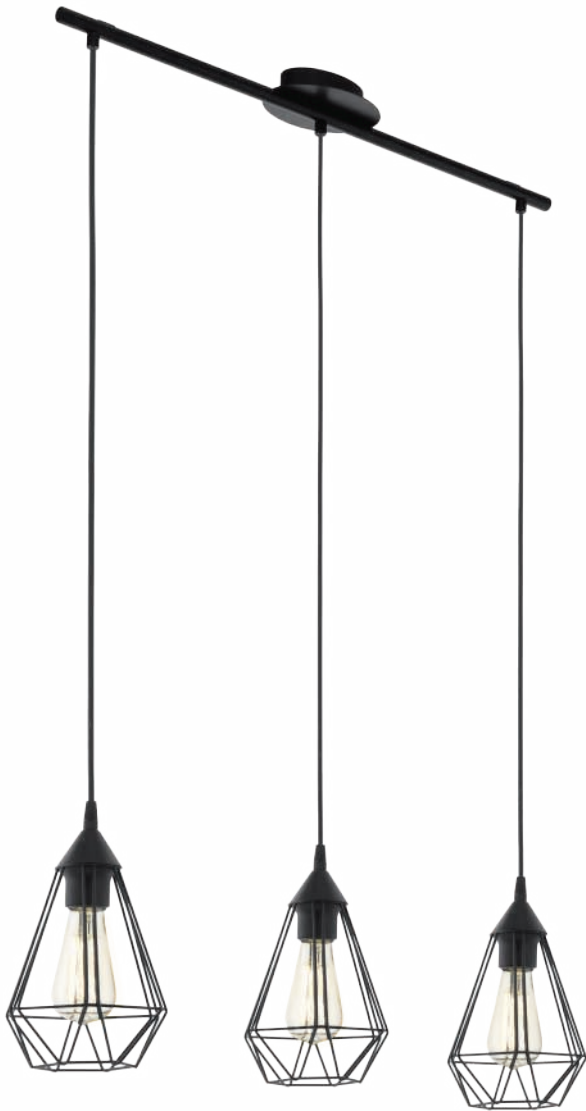

94189



94192

94189 TARBES

pendant light; steel, black / steel, black
 Hängeleuchte; Stahl, schwarz / Stahl, schwarz
 luminaire en suspension; acier, noir / acier, noir

L 790, B 175, H 1100



E27



3x 60W



9 002759 941895



94192 TARBES

table light; steel, black / steel, black
 Tischleuchte; Stahl, schwarz / Stahl, schwarz
 luminaire de table; acier, noir / acier, noir

H 265, Ø 175



E27



1x 60W



9 002759 941925

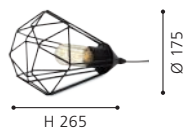

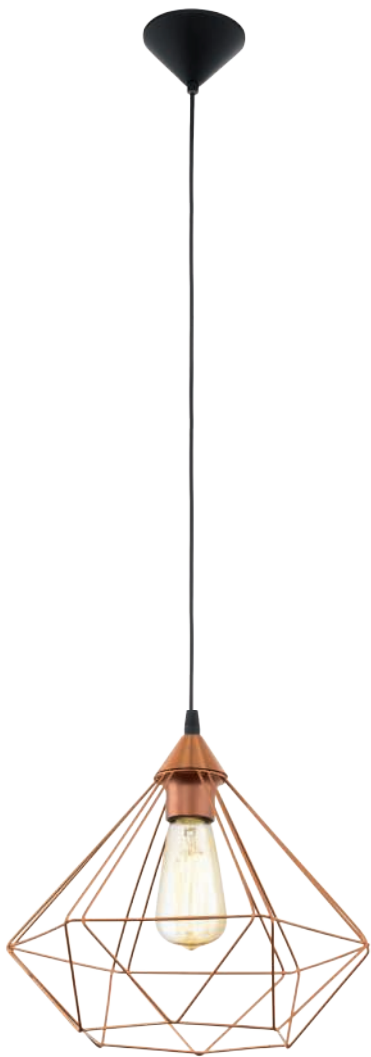

94194



94195

94194 TARDES

pendant light; plastic, black / steel, copper-coloured
 Hängeleuchte; Kunststoff, schwarz / Stahl, kupferfarben
 luminaire en suspension; plastique, noir / acier, cuivré

H 1100, Ø 325



E27 1x 60W



9 002759 941949

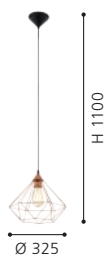

94195 TARDES

pendant light; steel, black / steel, copper-coloured
 Hängeleuchte; Stahl, schwarz / Stahl, kupferfarben
 luminaire en suspension; acier, noir / acier, cuivré

L 790, B 175, H 1100



E27 3x 60W



9 002759 941956

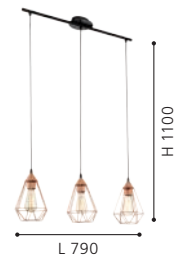



94196



94197



94193

94196 TARDES

pendant light; steel, black / steel, copper-coloured
Hängeleuchte; Stahl, schwarz / Stahl, kupferfarben
luminaire en suspension; acier, noir / acier, cuivré

H 1100, Ø 310



E27 3x 60W



9 002759 941963

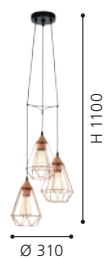

94197 TARDES

table light; steel, black / steel, copper-coloured
Tischleuchte; Stahl, schwarz / Stahl, kupferfarben
luminaire de table; acier, noir / acier, cuivré

H 265, Ø 175



E27 1x 60W



9 002759 941970

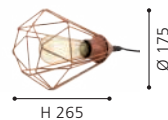

94193 TARDES

pendant light; plastic, black / steel, copper-coloured
Hängeleuchte; Kunststoff, schwarz / Stahl, kupferfarben
luminaire en suspension; plastique, noir / acier, cuivré

H 1100, Ø 175



E27 1x 60W



9 002759 941932

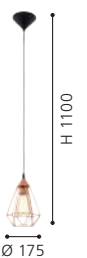



49643



49644

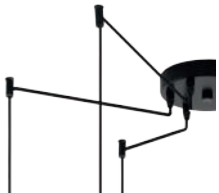

DETAIL 49643

The luminaire heads can be installed on the ceiling individually.
 Die Leuchtenköpfe können individuell an die Decke montiert werden.
 Les têtes de luminaires peuvent être montées individuellement au plafond.

49643 ROCCAMENA

pendant light; steel, black, copper
 Hängeleuchte; Stahl, schwarz, kupfer
 luminaire en suspension; acier, noir, cuivre

B 130, H 1300



E27



6x 60W



9 002759 496432



49644 ROCCAMENA

pendant light; steel, black, copper
 Hängeleuchte; Stahl, schwarz, kupfer
 luminaire en suspension; acier, noir, cuivre

H 1100, Ø 130



E27



1x 60W



9 002759 496449

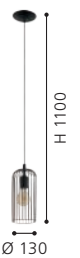



49645



49646

49646 ROCCAMENA

table light; steel, black, copper
Tischleuchte; Stahl, schwarz, kupfer
luminaire de table; acier, noir, cuivre

H 310, Ø 130, Base: Ø 130



E27 1x 60W



9 002759 496463



49645 ROCCAMENA

pendant light; steel, black, copper
Hängeleuchte; Stahl, schwarz, kupfer
luminaire en suspension; acier, noir, cuivre

L 730, B 130, H 1100



E27 3x 60W



9 002759 496456



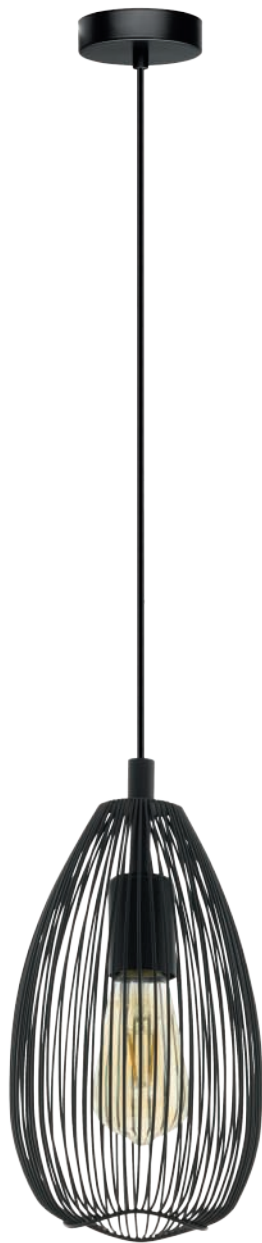

49141



49143

49141 CLEVEDON

pendant light; steel, black
Hängeleuchte; Stahl, schwarz
luminaire en suspension; acier, noir

H 1100, Ø 240



E27 1x 60W



9 002759 491413



49143 CLEVEDON

wall light; steel, black
Wandleuchte; Stahl, schwarz
applique; acier, noir

L 170, H 350, A 200



E27 1x 60W



9 002759 491437



49142 CLEVEDON

pendant light; steel, black
Hängeleuchte; Stahl, schwarz
luminaire en suspension; acier, noir

L 780, B 170, H 1100



E27 3x 60W



9 002759 491420





49142



49472



49477

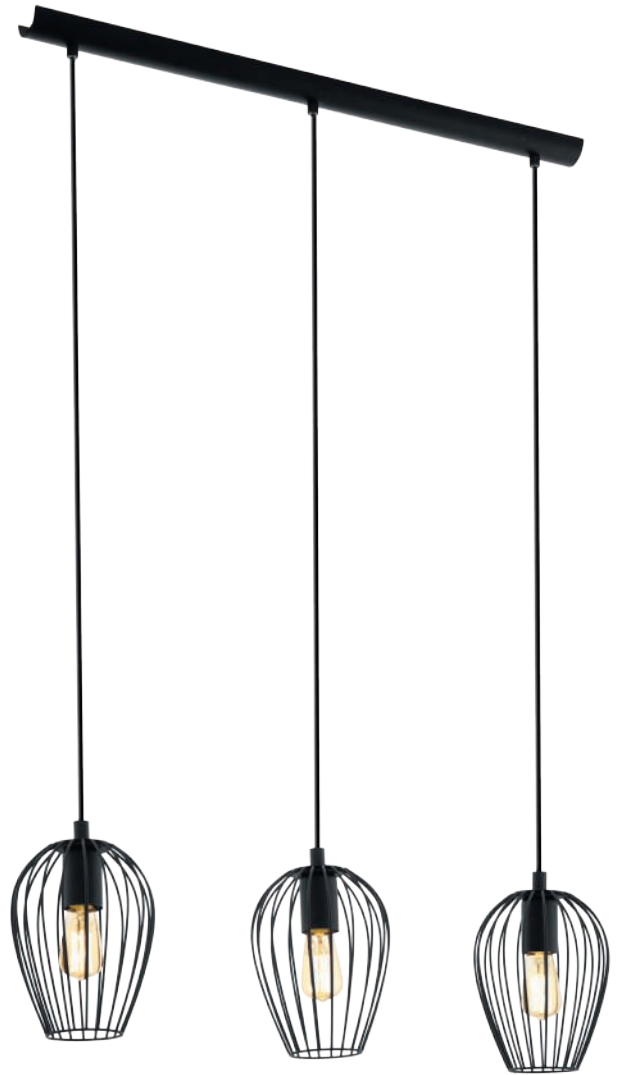

49478

49472 NEWTOWN

pendant light; steel, black
Hängeleuchte; Stahl, schwarz
luminaire en suspension; acier, noir

H 1100, Ø 275



E27 1x 60W



9 002759 494728



49477 NEWTOWN

pendant light; steel, black
Hängeleuchte; Stahl, schwarz
luminaire en suspension; acier, noir

H 1100, Ø 160



E27 1x 60W



9 002759 494773



49478 NEWTOWN

pendant light; steel, black
Hängeleuchte; Stahl, schwarz
luminaire en suspension; acier, noir

L 700, B 160, H 1100



E27 3x 60W



9 002759 494780





49479



49481



49474

49479 NEWTOWN

pendant light; steel, black
Hängeleuchte; Stahl, schwarz
luminaire en suspension; acier, noir

H 1300, Ø 380



E27 3x 60W



9 002759 494797



49481 NEWTOWN

table light; steel, black
Tischleuchte; Stahl, schwarz
luminaire de table; acier, noir

H 230, Ø 160, Base: Ø 120



E27 1x 60W



9 002759 494810



49474 NEWTOWN

floor light; steel, black
Stehleuchte; Stahl, schwarz
lampadaire; acier, noir

H 1595, Ø 275, Base: Ø 230



E27 1x 60W



9 002759 494742





49447

49448

49447 AUSTELL

pendant light; steel, black / steel, fabric, black, gold
 Hängeleuchte; Stahl, schwarz / Stahl, Textil, schwarz, gold
 luminaire en suspension; acier, noir / acier, tissu, noir, or

H 1100, Ø 165



E27 1x 60W



9 002759 494476

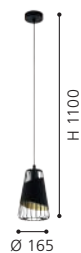

49448 AUSTELL

pendant light; steel, black / steel, fabric, black, gold
 Hängeleuchte; Stahl, schwarz / Stahl, Textil, schwarz, gold
 luminaire en suspension; acier, noir / acier, tissu, noir, or

L 765, B 165, H 1100



E27 3x 60W



9 002759 494483





49446



49509

49446 AUSTELL

pendant light; steel, black / steel, fabric, black, gold
 Hängeleuchte; Stahl, schwarz / Stahl, Textil, schwarz, gold
 luminaire en suspension; acier, noir / acier, tissu, noir, or

H 1100, Ø 360



E27



1x 60W



9 002759 494469



49509 AUSTELL

pendant light; steel, black / steel, fabric, black, gold
 Hängeleuchte; Stahl, schwarz / Stahl, Textil, schwarz, gold
 luminaire en suspension; acier, noir / acier, tissu, noir, or

H 1100, Ø 430



E27



1x 60W



9 002759 495091





43848





43847



43849



43848 PLIMSOLL

pendant light; steel, wood, black
Hängeleuchte; Stahl, Holz, schwarz
luminaire en suspension; acier, bois, noir

L 770, B 95, H 1100



E27

4x 40W



9 002759 438487

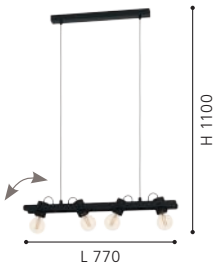

43847 PLIMSOLL

ceiling light; steel, wood, black
Deckenleuchte; Stahl, Holz, schwarz
plafonnier; acier, bois, noir

L 770, B 95, H 165



E27

4x 40W



9 002759 438470



43849 PLIMSOLL

table light; steel, wood, black
Tischleuchte; Stahl, Holz, schwarz
luminaire de table; acier, bois, noir

L 105, B 75, H 255, Base: Ø 135



E27

1x 40W



9 002759 438494

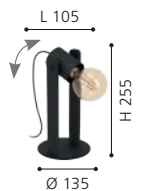

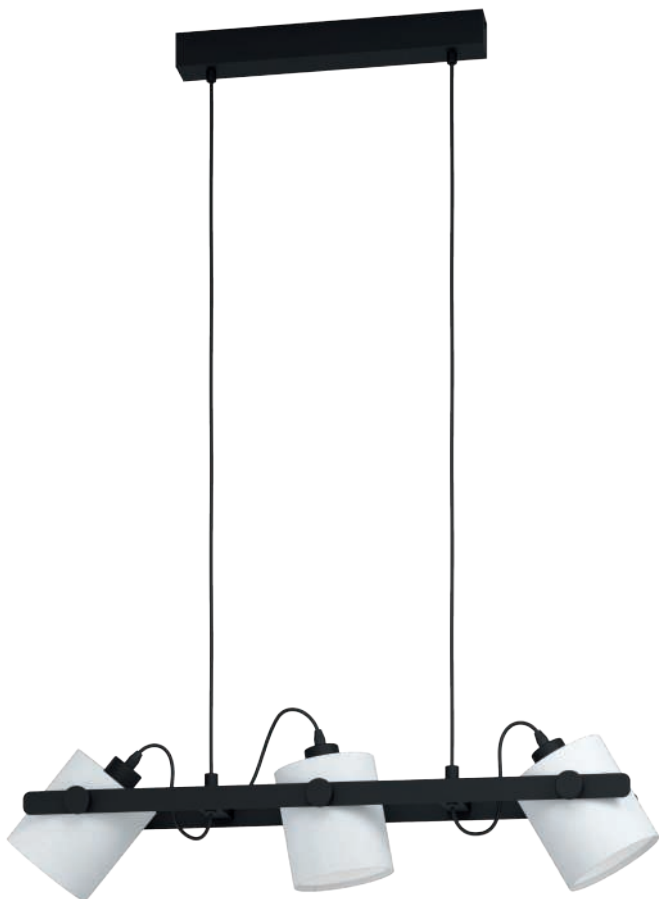

43426



43425



DETAIL HORNWOOD 1

The heads can be adjusted or fixed in position with the lateral screws.

Die Köpfe können mittels den seitlichen Schrauben verstellt oder fixiert werden.

Les têtes peuvent être réglées ou fixées à l'aide des vis latérales.

43426 HORNWOOD 1

pendant light; steel, wood, black / fabric, white
Hängeleuchte; Stahl, Holz, schwarz / Textil, weiss
luminaire en suspension; acier, bois, noir / tissu, blanc

L 780, B 195, H 1100



E27



3x 28W



9 002759 434267



43425 HORNWOOD 1

pendant light; steel, wood, black / fabric, white
Hängeleuchte; Stahl, Holz, schwarz / Textil, weiss
luminaire en suspension; acier, bois, noir / tissu, blanc

L 1100, B 180, H 1100



E27



4x 28W



9 002759 434250

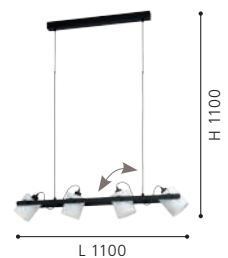



43428 HORNWOOD 1

table light; steel, wood, black / fabric, white
Tischleuchte; Stahl, Holz, schwarz / Textil, weiss
luminaire de table; acier, bois, noir / tissu, blanc

L 195, H 425, Base: Ø 180



43429 HORNWOOD 1

floor light; steel, wood, black / fabric, white
Stehleuchte; Stahl, Holz, schwarz / Textil, weiss
lampadaire; acier, bois, noir / tissu, blanc

L 215, H 1395, Base: Ø 230

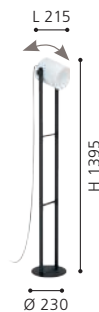

43427 HORNWOOD 1

wall light; steel, wood, black / fabric, white
Wandleuchte; Stahl, Holz, schwarz / Textil, weiss
applique; acier, bois, noir / tissu, blanc

L 195, A 255





43141

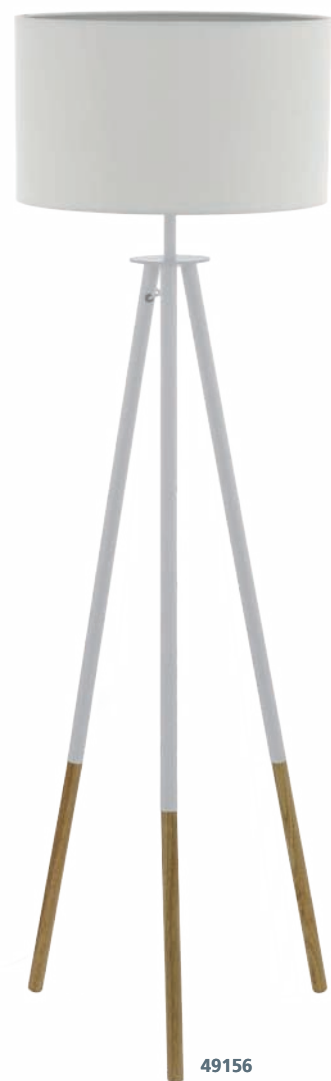

49156

43141 GLASTONBURY

floor light; steel, black / fabric, white
 Stehleuchte; Stahl, schwarz / Textil, weiss
 lampadaire; acier, noir / tissu, blanc

H 1510, Ø 240, Base: Ø 300



E27 1x 60W

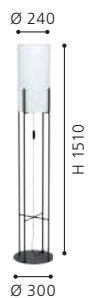

9 002759 431419

49156 BIDFORD

floor light; wood, steel, brown, white / fabric, white
 Stehleuchte; Holz, Stahl, braun, weiss / Textil, weiss
 lampadaire; bois, acier, marron, blanc / tissu, blanc

H 1540, Ø 460, Base: Ø 700



E27 1x 60W

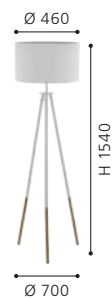

9 002759 491567



49148



94324



94326

49148 BIDFORD

floor light; wood, steel, brown / fabric, cappuccino, gold
 Stehleuchte; Holz, Stahl, braun / Textil, cappuccino, gold
 lampadaire; bois, acier, marron / tissu, cappuccino, or

H 1540, Ø 460, Base: Ø 700



E27 1x 60W



9 002759 491482

94324 LANTADA

floor light; wood, steel, natural / fabric, beige
 Stehleuchte; Holz, Stahl, natur / Textil, beige
 lampadaire; bois, acier, naturel / tissu, beige

H 1060 - 1430, Ø 450, Base: Ø 975



E27 1x 60W



9 002759 943240

94326 LANTADA

floor light; wood, steel, nut / fabric, taupe
 Stehleuchte; Holz, Stahl, nuss / Textil, taupe
 lampadaire; bois, acier, noisette / tissu, taupe

H 1060 - 1430, Ø 450, Base: Ø 975



E27 1x 60W



9 002759 943264



49386



49519



49385

49386 CHESTER

floor light; steel, black, copper
 Stehleuchte; Stahl, schwarz, kupfer
 lampadaire; acier, noir, cuivre

L 600, B 600, H 1495, Base: Ø 693



E27 1x 60W

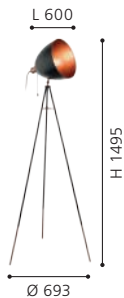

9 002759 493868

49519 CHESTER 1

floor light; steel, rust-coloured, gold
 Stehleuchte; Stahl, rostfarben, gold
 lampadaire; acier, rouille, or

L 600, B 600, H 1495, Base: Ø 693

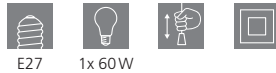

E27 1x 60W



9 002759 495190

49385 CHESTER

table light; steel, black, copper
 Tischleuchte; Stahl, schwarz, kupfer
 luminaire de table; acier, noir, cuivre

L 290, B 290, H 440



E27 1x 60W



9 002759 493851

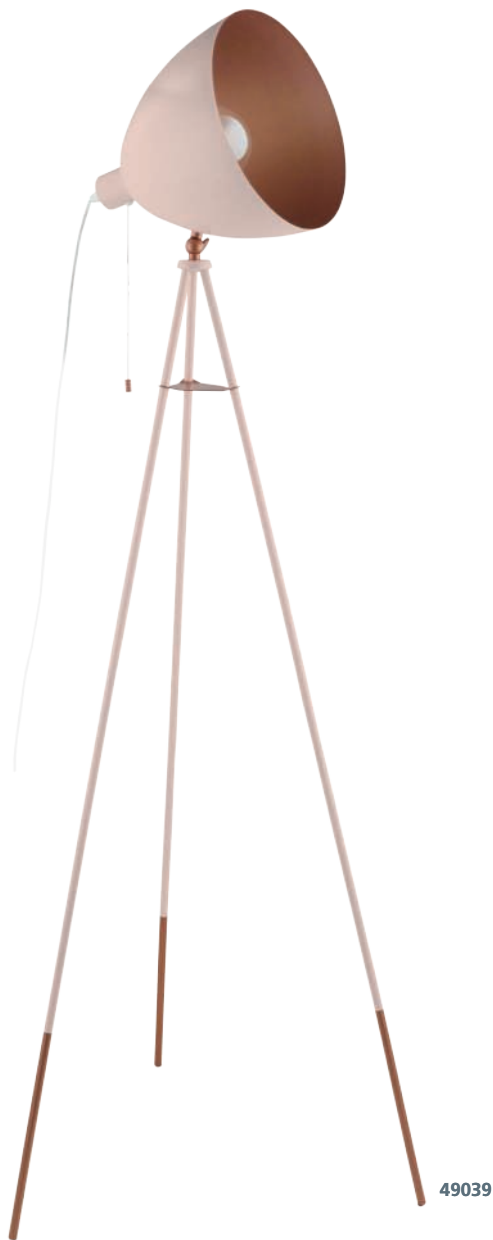

49039



49342

49039 CHESTER-P

floor light; steel, pastel apricot, copper
Stehleuchte; Stahl, Pastell apricot, kupfer
lampadaire; acier, pastel abricot, cuivre

L 600, B 600, H 1495, Base: Ø 693



E27 1x 60W

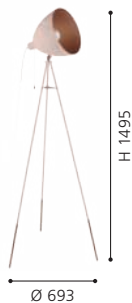

H 1495

Ø 693



9 002759 490393

49342 DUNDEE

floor light; steel, mint, copper-coloured / steel, mint, white
Stehleuchte; Stahl, mint, kupferfarben / Stahl, mint, weiss
lampadaire; acier, menthe, cuivré / acier, menthe, blanc

H 1355, Base: Ø 600



E27 1x 60W



H 1355

Ø 600



9 002759 493424

49337 DUNDEE

table light; steel, mint, copper-coloured / steel, mint, white
Tischleuchte; Stahl, mint, kupferfarben / Stahl, mint, weiss
luminaire de table; acier, menthe, cuivré / acier, menthe, blanc

H 440, Base: Ø 290



E27 1x 60W

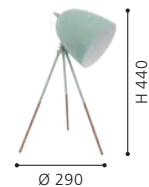

H 440

Ø 290



9 002759 493370



49337



43633



43634

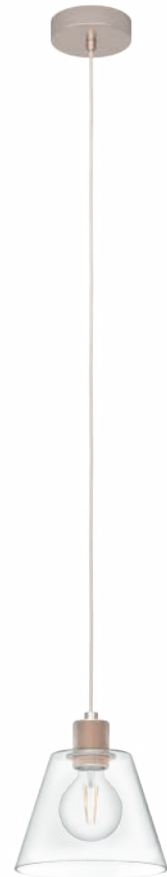

43631

43633 COPLEY

pendant light; steel, aluminium, gold-coloured / glass, clear
Hängeleuchte; Stahl, Alu, goldfarben / Glas, klar
luminaire en suspension; acier, aluminium, or / verre, transparent

H 1100, Ø 200



E27 1x 40W



9 002759 436339



43634 COPLEY

pendant light; steel, aluminium, gold-coloured / glass, clear
Hängeleuchte; Stahl, Alu, goldfarben / Glas, klar
luminaire en suspension; acier, aluminium, or / verre, transparent

L 900, B 200, H 1100



E27 3x 40W



9 002759 436346



43631 COPLEY

pendant light; steel, aluminium, rose gold / glass, clear
Hängeleuchte; Stahl, Alu, roségold / Glas, klar
luminaire en suspension; acier, aluminium, rose or / verre, transparent

H 1100, Ø 200



E27 1x 40W



9 002759 436315

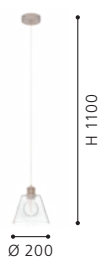



43632

43632 COPLEY

pendant light; steel, aluminium, rose gold / glass, clear
Hängeleuchte; Stahl, Alu, roségold / Glas, klar
luminaire en suspension; acier, aluminium, rose or / verre,
transparent

L 900, B 200, H 1100



E27



3x 40W



9 002759 436322

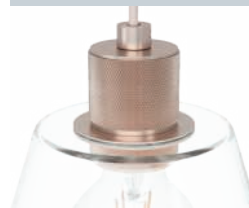

DETAIL COPLEY

This luminaire has a special socket.
Diese Leuchte verfügt über eine
spezielle Fassung.
Cette luminaire a une douille spéciale.

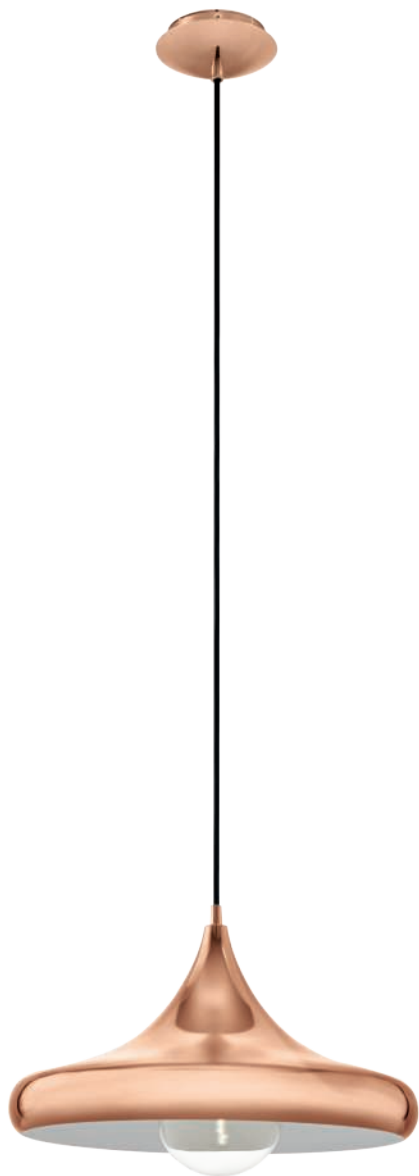

94742

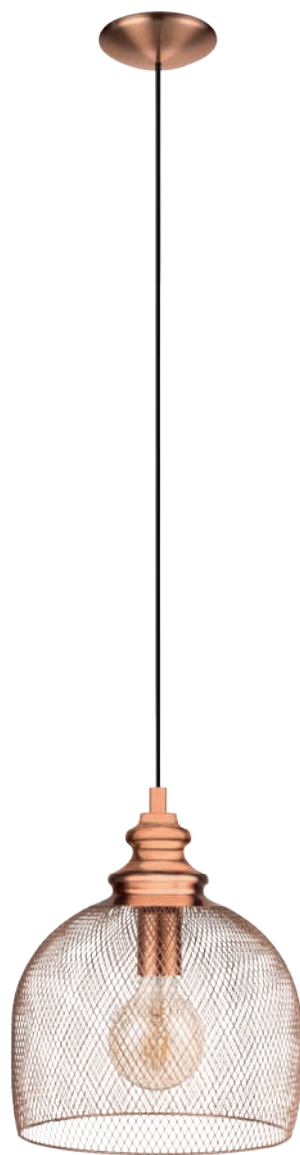

49738

94742 CORETTO 2

pendant light; steel, copper
Hängeleuchte; Stahl, kupfer
luminaire en suspension; acier, cuivre

H 1100, Ø 400



E27



1x 60W



9 002759 947422

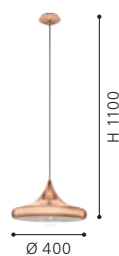

49738 STRAITON

pendant light; steel, copper
Hängeleuchte; Stahl, kupfer
luminaire en suspension; acier, cuivre

H 1100, Ø 280



E27



1x 60W



9 002759 497385

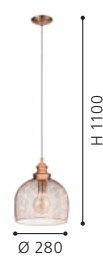

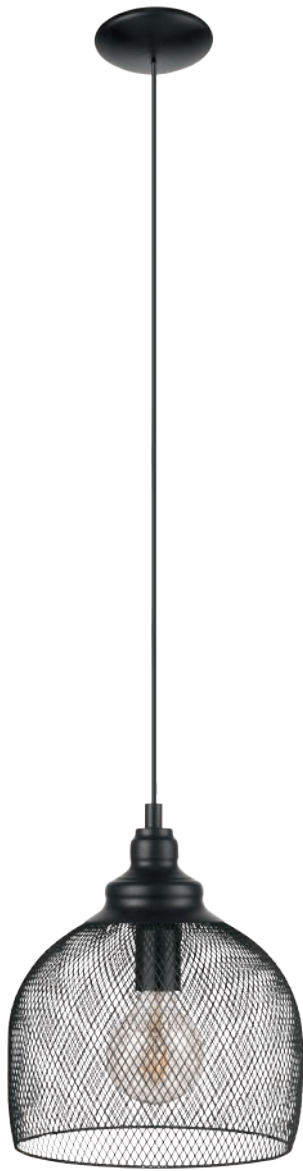

49736



49449

49736 STRAITON

pendant light; steel, black
 Hängeleuchte; Stahl, schwarz
 luminaire en suspension; acier, noir

H 1100, Ø 280



E27



1x 60W



9 002759 497361



49449 HAPTON

pendant light; steel, copper
 Hängeleuchte; Stahl, kupfer
 luminaire en suspension; acier, cuivre

H 1100, Ø 290



E27



1x 60W



9 002759 494490





43331

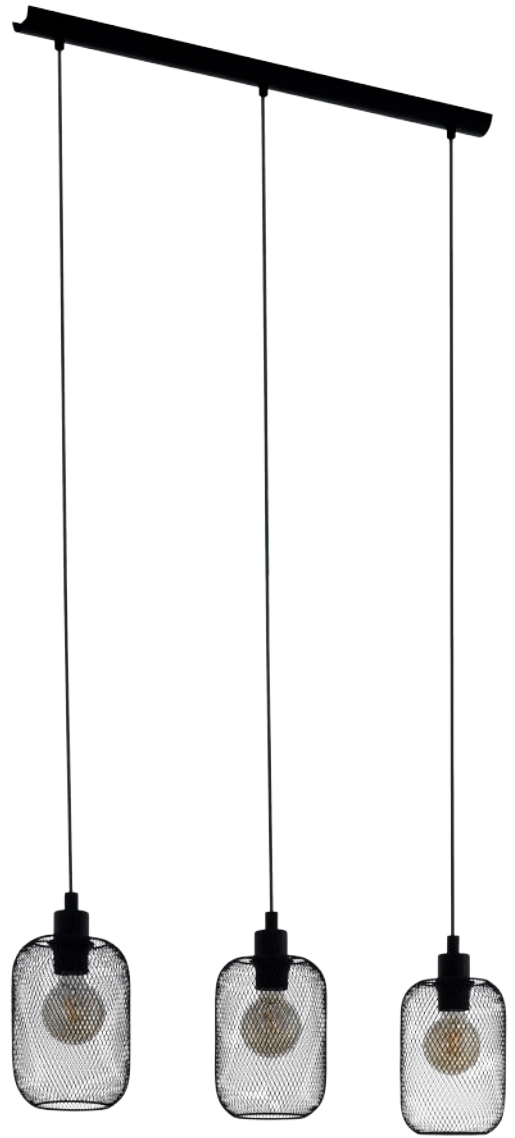

43333

43331 WRINGTON

pendant light; steel, black
Hängeleuchte; Stahl, schwarz
luminaire en suspension; acier, noir

H 1100, Ø 300



E27



1x 60W



9 002759 433314



43333 WRINGTON

pendant light; steel, black
Hängeleuchte; Stahl, schwarz
luminaire en suspension; acier, noir

L 740, B 150, H 1100



E27



3x 60W



9 002759 433338

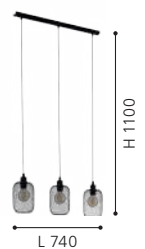



43334



43096



32468

43334 WRINGTON

pendant light; steel, black
Hängeleuchte; Stahl, schwarz
luminaire en suspension; acier, noir

H 1500, Ø 540



E27



5x 60W



9 002759 433345



43096 WRINGTON

table light; steel, black
Tischleuchte; Stahl, schwarz
luminaire de table; acier, noir

H 285, Ø 150, Base: Ø 100



E27



1x 60W



9 002759 430962



32468 WRINGTON

floor light; steel, black
Stehleuchte; Stahl, schwarz
lampadaire; acier, noir

L 635, B 300, H 1940, Base: Ø 300



E27



1x 60W



9 002759 324681

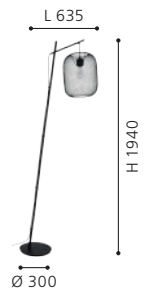

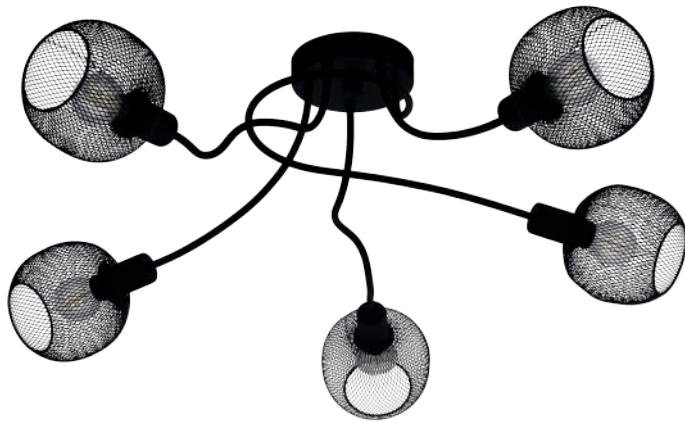

43374



43376



43377

43374 WRINGTON 1

ceiling light; steel, black
Deckenleuchte; Stahl, schwarz
plafonnier; acier, noir

H 255, Ø 755



E14 5x 40W



9 002759 433741

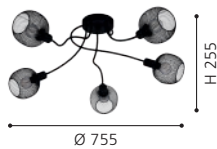

43376 WRINGTON 1

table light; steel, black
Tischleuchte; Stahl, schwarz
luminaire de table; acier, noir

L 305, B 195, H 405, Base: Ø 145



E14 2x 40W



9 002759 433765



43377 WRINGTON 1

floor light; steel, black
Stehleuchte; Stahl, schwarz
lampadaire; acier, noir

L 340, B 305, H 1495, Base: Ø 230



E14 3x 40W



9 002759 433772

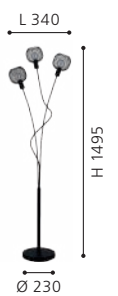



43375

43375 WRINGTON 1

wall light; steel, black
Wandleuchte; Stahl, schwarz
applique; acier, noir

L 385, H 355, A 195



E14



2x 40W



9 002759 433758

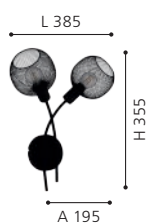



43303

43303 POMPEYA

ceiling light; steel, black
Deckenleuchte; Stahl, schwarz
plafonnier; acier, noir

L 450, B 440, H 255



E27



1x 60W



9 002759 433031



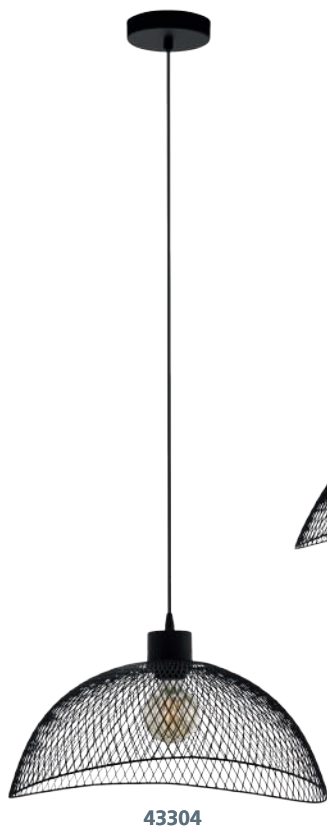

43304

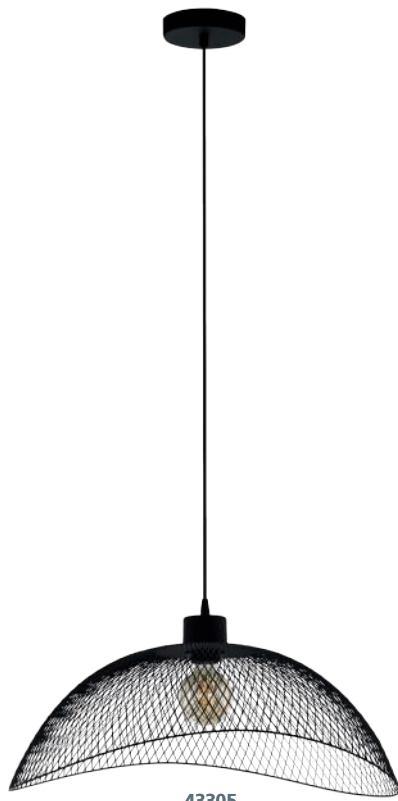

43305

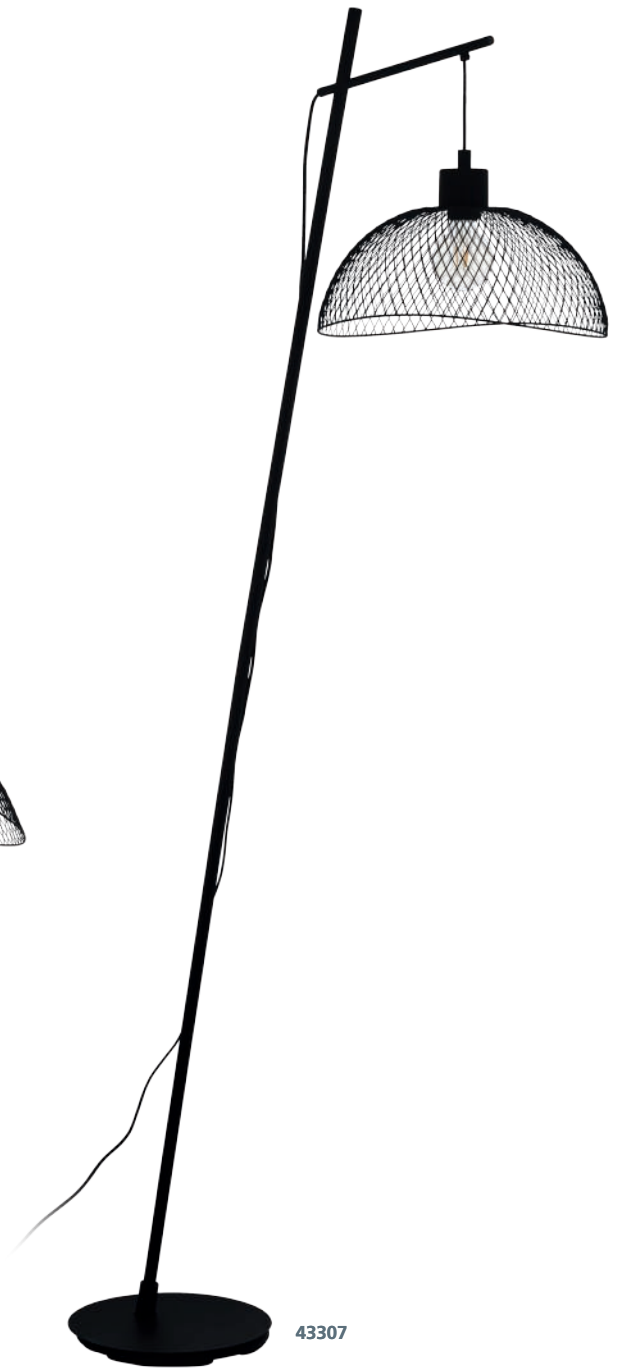

43307

43304 POMPEYA

pendant light; steel, black
Hängeleuchte; Stahl, schwarz
luminaire en suspension; acier, noir

L 450, B 440, H 1100



E27 1x 60W



9 002759 433048



43305 POMPEYA

pendant light; steel, black
Hängeleuchte; Stahl, schwarz
luminaire en suspension; acier, noir

L 570, B 540, H 1100



E27 1x 60W



9 002759 433055



43307 POMPEYA

floor light; steel, black
Stehleuchte; Stahl, schwarz
lampadaire; acier, noir

L 860, B 390, H 1910, Base: Ø 290

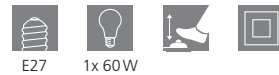

E27 1x 60W



9 002759 433079

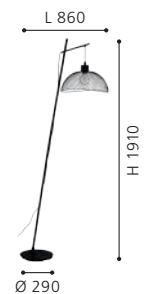



43669

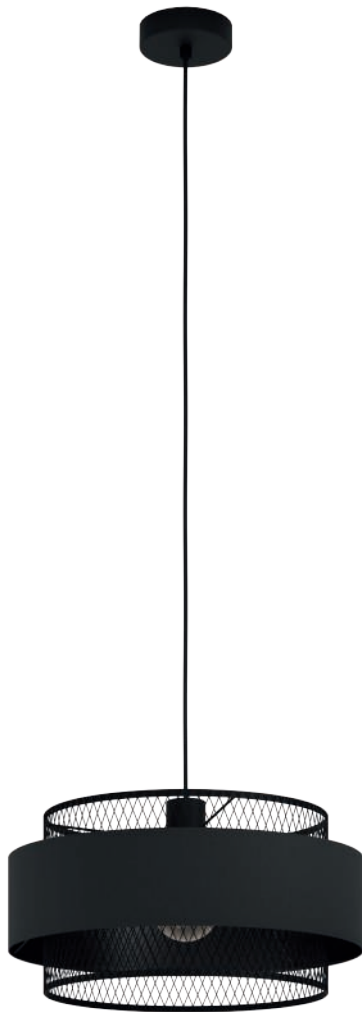

43668



43559

43669 BAZELY

pendant light; steel, black / fabric, black
 Hängeleuchte; Stahl, schwarz / Textil, schwarz
 luminaire en suspension; acier, noir / tissu, noir

L 990, B 230, H 1100



E27

3x 40W



9 002759 436681



43668 BAZELY

pendant light; steel, black / fabric, black
 Hängeleuchte; Stahl, schwarz / Textil, schwarz
 luminaire en suspension; acier, noir / tissu, noir

H 1100, Ø 400



E27

1x 40W



9 002759 436681



43559 SALLICANO

pendant light; steel, black, gold
 Hängeleuchte; Stahl, schwarz, gold
 luminaire en suspension; acier, noir, or

L 730, B 200, H 1100



E27

3x 40W



9 002759 435592

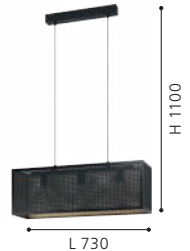



43841

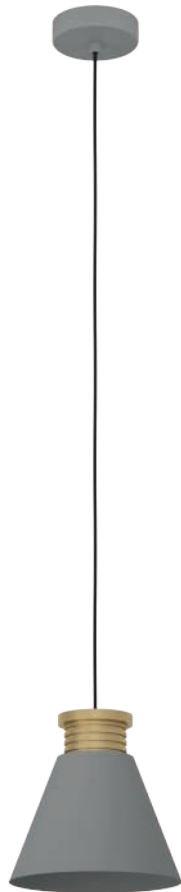

43838



43839

43841 TWICKEN

table light; steel, grey, gold
Tischleuchte; Stahl, grau, gold
luminaire de table; acier, gris, or

L 155, B 150, H 195, Base: B 155



E27 1x 28W



9 002759 438418



43838 TWICKEN

pendant light; steel, grey, gold
Hängeleuchte; Stahl, grau, gold
luminaire en suspension; acier, gris, or

H 1100, Ø 220



E27 1x 40W



9 002759 438388



43839 TWICKEN

pendant light; steel, grey, gold
Hängeleuchte; Stahl, grau, gold
luminaire en suspension; acier, gris, or

L 920, B 220, H 1100



E27 3x 40W



9 002759 438395

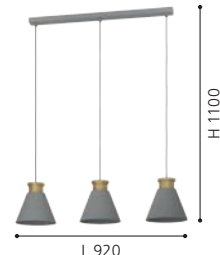



43835

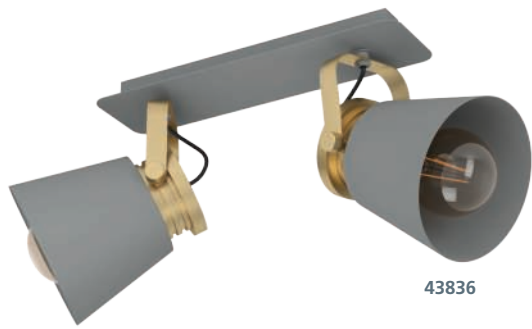

43836



43837

43835 TWICKEN

spot; steel, grey, gold
Spot; Stahl, grau, gold
spot; acier, gris, or

L 180, B 150, H 200



E27



1x 28W



9 002759 438357



L 180

H 200

43836 TWICKEN

spot; steel, grey, gold
Spot; Stahl, grau, gold
spot; acier, gris, or

L 370, B 205, H 175



E27



2x 40W



9 002759 438364



L 370

H 175

43837 TWICKEN

spot; steel, grey, gold
Spot; Stahl, grau, gold
spot; acier, gris, or

L 590, B 205, H 175



E27



3x 40W



9 002759 438371



L 590

H 175



43825



**DESIGN
HIGHLIGHT
DETAIL**

43825 MATLOCK
pendant light; steel, grey, black
Hängeleuchte; Stahl, grau, schwarz
luminaire en suspension; acier, gris, noir

H 1100, Ø 380

  
E27 1x 40W

9 002759 438258



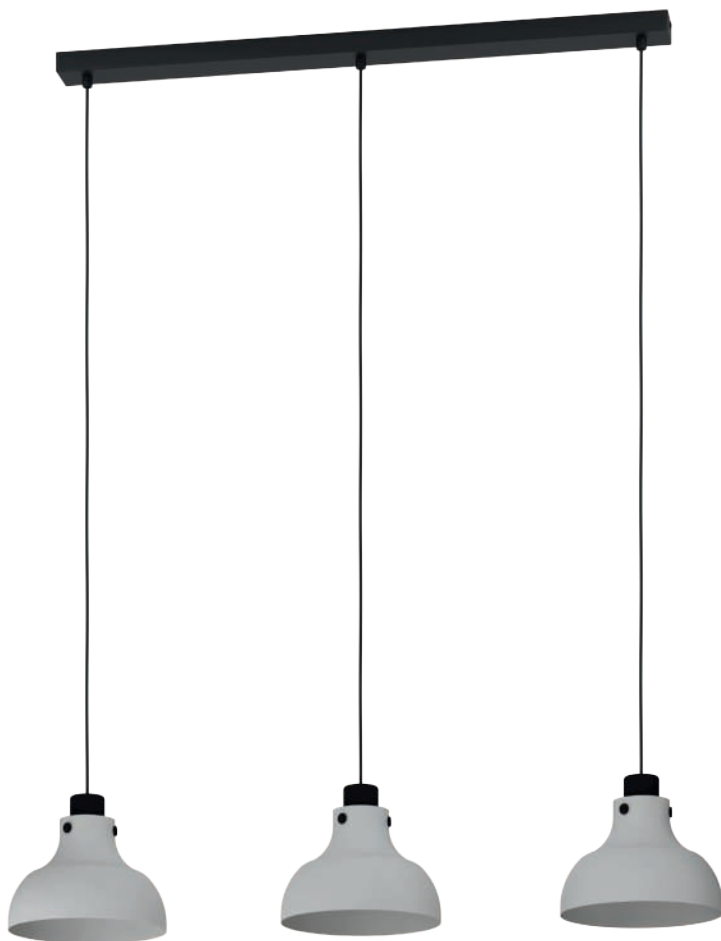

43826



43842



43844

43826 MATLOCK

pendant light; steel, grey, black
Hängeleuchte; Stahl, grau, schwarz
luminaire en suspension; acier, gris, noir

L 900, B 200, H 1100



E27



3x 40W



9 002759 438265

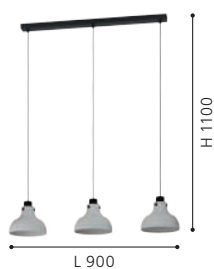

43842 MATLOCK

ceiling light; steel, grey, black
Deckenleuchte; Stahl, grau, schwarz
plafonnier; acier, gris, noir

H 210, Ø 380



E27



1x 40W



9 002759 438425



43844 MATLOCK

floor light; steel, grey, black
Stehleuchte; Stahl, grau, schwarz
lampadaire; acier, gris, noir

L 405, B 200, H 1580, Base: B 230



E27



1x 40W



9 002759 438449

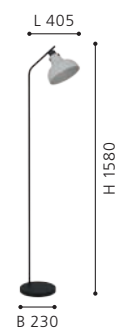



43829



43827



43828

43829 MATLOCK

spot; steel, wood, grey, black
Spot; Stahl, Holz, grau, schwarz
spot; acier, bois, gris, noir

L 740, B 145, H 225



E27 3x 40W



9 002759 438296



L 740

43827 MATLOCK

spot; steel, grey, black
Spot; Stahl, grau, schwarz
spot; acier, gris, noir

L 245, B 145, H 225



E27 1x 40W



9 002759 438272



L 245

H 225

43828 MATLOCK

spot; steel, wood, grey, black
Spot; Stahl, Holz, grau, schwarz
spot; acier, bois, gris, noir

L 520, B 145, H 225



E27 2x 40W



9 002759 438289



L 520

H 225



43843

43843 MATLOCK

wall light; steel, grey, black
Wandleuchte; Stahl, grau, schwarz
applique; acier, gris, noir

L 200, H 250, A 800



E27



1x 40W



9 002759 438432



39831



39832

39831 GIACONECCHIA

pendant light; steel, anthracite / terrazzo, grey
 Hängeleuchte; Stahl, anthrazit / Terrazzo, grau
 luminaire en suspension; acier, gris anthracite / terrazzo, gris

H 1100, Ø 105



E27



1x 40W



9 002759 398316



39832 GIACONECCHIA

pendant light; steel, anthracite / terrazzo, grey
 Hängeleuchte; Stahl, anthrazit / Terrazzo, grau
 luminaire en suspension; acier, gris anthracite / terrazzo, gris

L 975, B 55, H 1100



E27



4x 40W



9 002759 398323

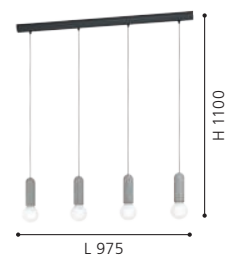

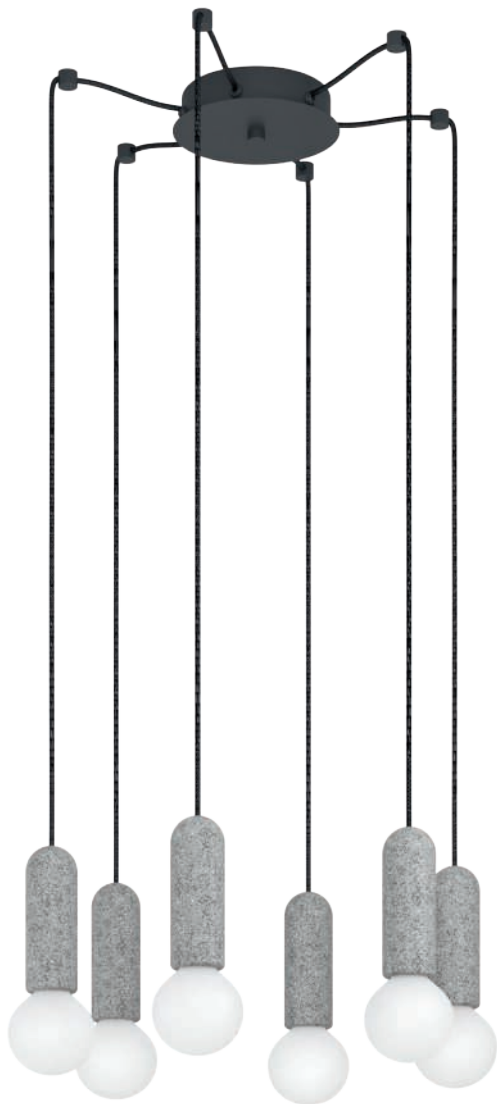

39833



39835



39834

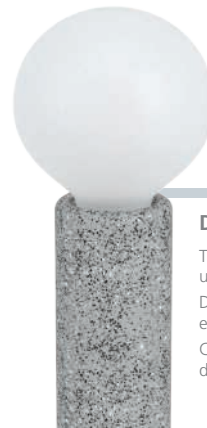

DETAIL GIACONECCHIA

These luminaires have a unique stone look.
Diese Leuchten haben eine einzigartige Steinoptik.
Ces lumières ont un aspect de pierre unique.

39833 GIACONECCHIA

pendant light; steel, anthracite / terrazzo, grey
Hängeleuchte; Stahl, anthrazit / Terrazzo, grau
luminaire en suspension; acier, gris anthracite / terrazzo, gris

H 1500, Ø 535



E27 6x 40W



9 002759 398330

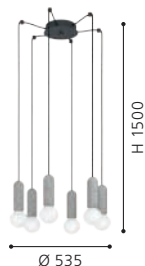

39835 GIACONECCHIA

table light; steel, anthracite / terrazzo, grey
Tischleuchte; Stahl, anthrazit / Terrazzo, grau
luminaire de table; acier, gris anthracite / terrazzo, gris

H 175, Ø 55, Base: Ø 130



E27 1x 40W



9 002759 398354



39834 GIACONECCHIA

wall light; steel, anthracite / terrazzo, grey
Wandleuchte; Stahl, anthrazit / Terrazzo, grau
applique; acier, gris anthracite / terrazzo, gris

L 55, H 205, A 105



E27 1x 40W



9 002759 398347





43595

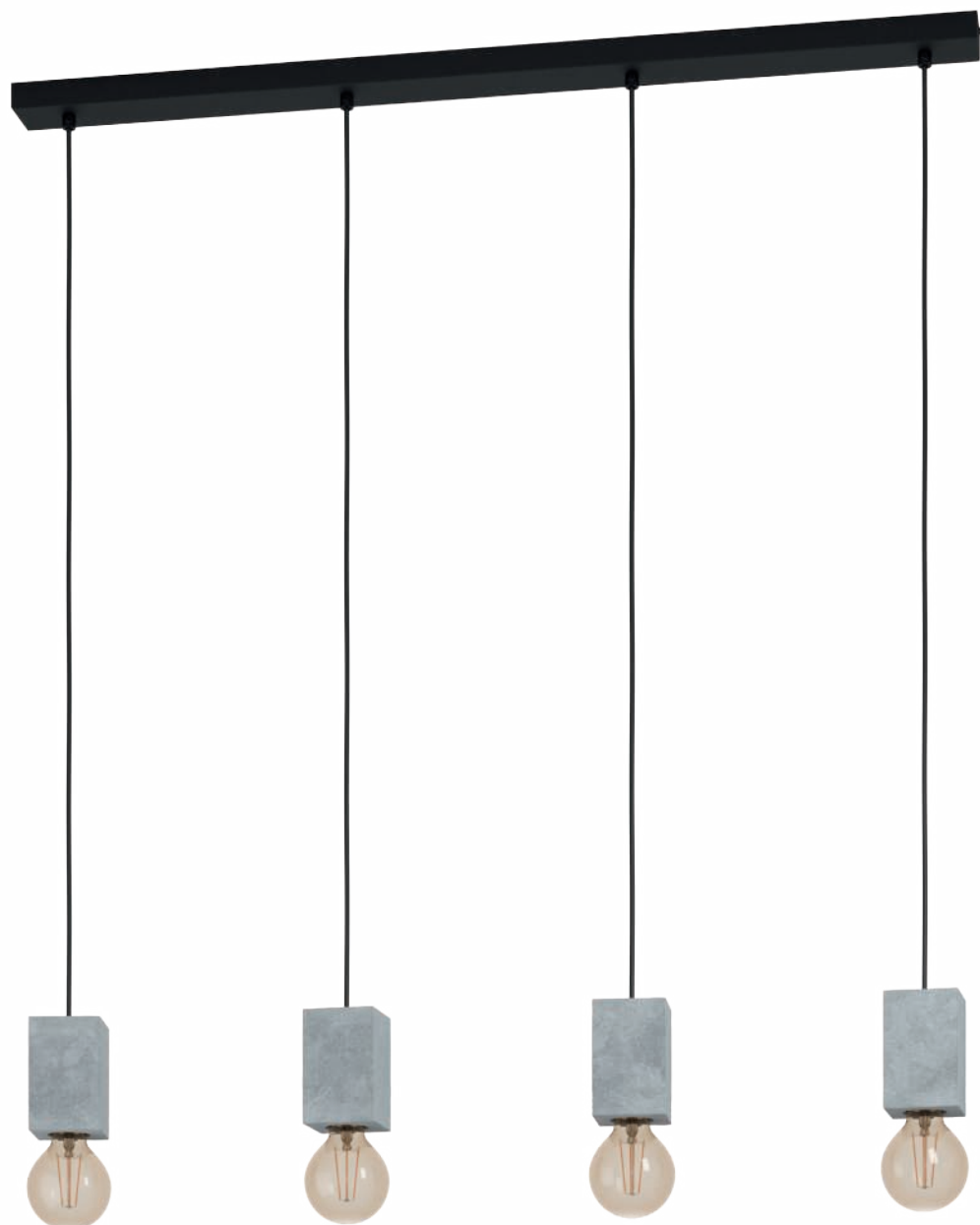

43598

43595 PRESTWICK 3

ceiling light; steel, black / concrete, grey
Deckenleuchte; Stahl, schwarz / Beton, grau
plafonnier; acier, noir / béton, gris

L 90, B 90, H 110



E27



1x 40W



9 002759 435950



43598 PRESTWICK 3

pendant light; steel, black / concrete, grey
Hängeleuchte; Stahl, schwarz / Beton, grau
luminaire en suspension; acier, noir / béton, gris

L 925, B 55, H 1100



E27



4x 40W



9 002759 435981

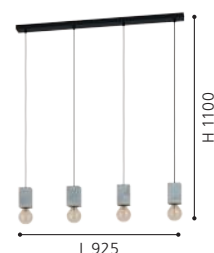



43597



43596

43597 PRESTWICK 3

pendant light; steel, black / concrete, grey
 Hängeleuchte; Stahl, schwarz / Beton, grau
 luminaire en suspension; acier, noir / béton, gris

H 1100, Ø 70



E27



1x 40W



9 002759 435974



43596 PRESTWICK 3

ceiling light; steel, black / concrete, grey
 Deckenleuchte; Stahl, schwarz / Beton, grau
 plafonnier; acier, noir / béton, gris

L 490, B 90, H 110



E27



3x 40W



9 002759 435967

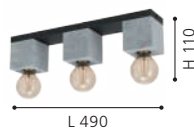



49812



49111

49812 PRESTWICK

table light; ceramic, grey
Tischleuchte; Keramik, grau
luminaire de table; céramique, gris

L 90, B 90, H 130



E27 1x 60W



9 002759 498122



49111 LYNTON

table light; concrete, grey
Tischleuchte; Beton, grau
luminaire de table; béton, gris

H 270, Ø 140



E27 1x 60W



9 002759 491116



43615 FRIJOLAS

table light; steel, black
Tischleuchte; Stahl, schwarz
luminaire de table; acier, noir

L 240, B 30, H 245, Base: Ø 120

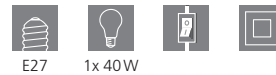

E27 1x 40W



9 002759 436155





43615

VINTAGE

Did you know that the word Vintage originally meant „wine harvest“? Vintage style means a piece of furniture built anew but designed in a „used look“. Genuine vintage pieces from the 1920s to 1980s can be found in flea markets or in the attic, by contrast. Genuine or as imitations: Vintage reminds us of the good old days: summer holidays with the grandparents, the first ride in grandpa's vintage car and the best apple pie from grandma's enamelled mould. Travel through time, and enjoy feelings of nostalgia with a glass of wine. We recommend accompanying the wine with a taste of our vintage product range.

Wussten Sie, dass das Wort Vintage ursprünglich „Weinlese“ bedeutet? Vom Vintage-Stil spricht man, wenn ein Einrichtungsstück neu gebaut, aber im „Used-Look“ designt ist. Echte Vintage-Stücke aus den 20er bis 80er-Jahren findet man hingegen auf Flohmärkten oder am Dachboden. Ob echt oder nachgebaut, Vintage erinnert uns an die gute alte Zeit: Sommerferien bei den Großeltern, die erste Fahrt mit Opas Oldtimer und der beste Apfelkuchen aus Omas Emaille-Form. Erleben Sie eine Zeitreise, schwelgen Sie in Nostalgiegefühlen und schenken Sie sich ein Glas Wein ein. Als Weinbegleitung empfehlen wir ein Reinschnuppern in unsere Vintage-Produktserie.

Est-ce que vous saviez que le mot Vintage voulait originellement dire « vendanges » ? Lorsqu'une pièce de décor est fabriquée à neuf, mais qu'elle est conçue dans le « Used-Look » (look usé), l'on parle de style Vintage. Contrairement, des vraies pièces Vintage, des années 20 jusqu'aux années 80, se trouvent soit sur le marché aux puces, soit au grenier. Qu'elles soient réelles ou imitées, Vintage nous rappelle le bon vieux temps : les vacances d'été chez les grands-parents, la première conduite avec la voiture de collection du grand-père et la meilleure tarte aux pommes du moule en émail de la grand-mère. Découvrez un voyage dans le temps, festoyez dans des sentiments nostalgiques et versez-vous un verre de vin. Nous recommandons, comme accompagnement de vin, un reniflement dans notre série de produit Vintage.





VINOZA
p. 196



GILTSPUR
p. 198



CHISLE
p. 199



RUSCOMB
p. 200



WOOTTON
p. 202-203



YOUNGSTOWN
p. 204



RAMPIDE 1
p. 204



FINDLAY
p. 205



RAMPIDE
p. 205-207



COTTINGHAM
p. 208



TARLE
p. 208



PADSTOW
p. 208-209



HORNINGTOPS
p. 209



RODING
p. 210



HODSOLL
p. 211



CHERTSEY
p. 212



MEOPHAM
p. 212



STOCKBURY
p. 213



HOGSMILL
p. 214



BRIDPORT
p. 215



LATCHELY
p. 215



This product is available in different colors and shapes./ Dieser Artikel ist in unterschiedlichen Farben und Formen verfügbar.
Cet article est disponible en différentes couleurs et formes.



43824

43824 VINOZA

table light; ceramic, white / fabric, black
 Tischleuchte; Keramik, weiss / Textil, schwarz
 luminaire de table; céramique, blanc / tissu, noir

H 505, Ø 300, Base: Ø 120



E27 1x 40W



9 002759 438241



43823 VINOZA

table light; ceramic, black / fabric, white
 Tischleuchte; Keramik, schwarz / Textil, weiss
 luminaire de table; céramique, noir / tissu, blanc

H 505, Ø 300, Base: Ø 120



E27 1x 40W



9 002759 438234





43823



43554



43553

43554 GILTSPUR

pendant light; steel, black
Hängeleuchte; Stahl, schwarz
luminaire en suspension; acier, noir

L 770, B 180, H 1100



E27



3x 40W



9 002759 435547



43553 GILTSPUR

ceiling light; steel, black
Deckenleuchte; Stahl, schwarz
plafonnier; acier, noir

H 230, Ø 550



E27



3x 40W



9 002759 435530

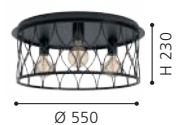



43527



43499



43528

DETAIL CHISLE

The mixture of steel and vaporized glass gives these luminaires a unique look.

Die Mischung aus Stahl und bedampftem Glas verleiht diesen Leuchten eine besondere Optik. Le mélange d'acier et de verre vaporisé donne à ces luminaires un look unique.



43527 CHISLE

pendant light; steel, black, bronzed / glass vaporized, amber
Hängeleuchte; Stahl, schwarz, brüniert / Glas bedampft, ambre
luminaire en suspension; acier, noir, brun / verre vaporisé, ambre

H 1100, Ø 165



E27



1x 40W



9 002759 435271



43499 CHISLE

pendant light; steel, black, bronzed / glass vaporized, amber
Hängeleuchte; Stahl, schwarz, brüniert / Glas bedampft, ambre
luminaire en suspension; acier, noir, brun / verre vaporisé, ambre

H 1300, Ø 425



E27



3x 40W



9 002759 434991



43528 CHISLE

pendant light; steel, black, bronzed / glass vaporized, amber
Hängeleuchte; Stahl, schwarz, brüniert / Glas bedampft, ambre
luminaire en suspension; acier, noir, brun / verre vaporisé, ambre

L 1300, B 165, H 1100



E27



4x 40W



9 002759 435288

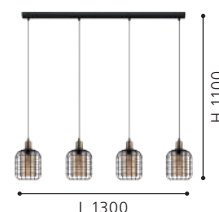



43494



43495

43494 RUSCOMB

spot; steel, black / paper, plastic, natural
Spot; Stahl, schwarz / Papier, Kunststoff, natur
spot; acier, noir / papier, plastique, nature

L 440, H 175, A 285



E27 2x 10W



9 002759 434946



43495 RUSCOMB

spot; steel, black / paper, plastic, natural
Spot; Stahl, schwarz / Papier, Kunststoff, natur
spot; acier, noir / papier, plastique, nature

L 775, H 175, A 235



E27 3x 10W



9 002759 434953



43493 RUSCOMB

spot; steel, black / paper, plastic, natural
Spot; Stahl, schwarz / Papier, Kunststoff, natur
spot; acier, noir / papier, plastique, nature

L 135, H 175, A 210



E27 1x 10W



9 002759 434939





43493

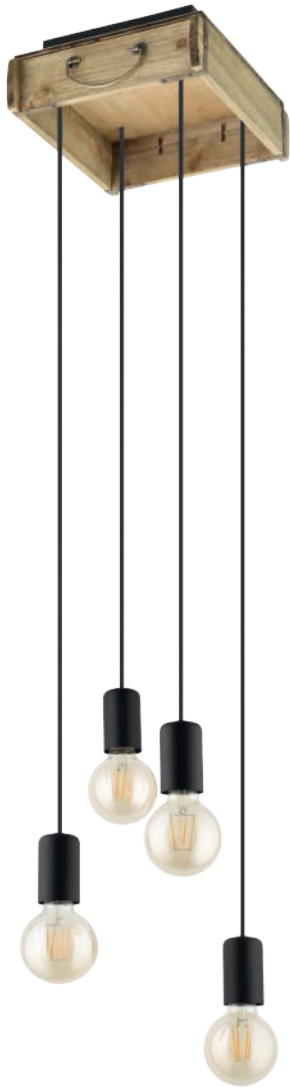

43591



43593



43592

43591 WOOTTON

pendant light; wood, steel, brown, black
 Hängeleuchte; Holz, Stahl, braun, schwarz
 luminaire en suspension; bois, acier, marron, noir

L 250, B 280, H 1100



E27 4x 40W



9 002759 435912



43593 WOOTTON

wall light; wood, steel, brown, black
 Wandleuchte; Holz, Stahl, braun, schwarz
 applique; bois, acier, marron, noir

L 145, H 270, A 115



E27 1x 40W



9 002759 435936



43592 WOOTTON

pendant light; wood, steel, brown, black
 Hängeleuchte; Holz, Stahl, braun, schwarz
 luminaire en suspension; bois, acier, marron, noir

L 810, B 220, H 1100



E27 6x 40W



9 002759 435929





43594

43594 WOOTTON

table light; wood, steel, brown, black
Tischleuchte; Holz, Stahl, braun, schwarz
luminaire de table; bois, acier, marron, noir

L 250, B 220, H 375



E27



3x 40W



9 002759 435943



DESIGN
HIGHLIGHT
DETAIL



43318



43319



43351

43318 YOUNGSTOWN

pendant light; steel, wood, black, brown
 Hängeleuchte; Stahl, Holz, schwarz, braun
 luminaire en suspension; acier, bois, noir, marron

L 700, B 45, H 1100



E27 4x 40W



9 002759 433185



43319 YOUNGSTOWN

pendant light; steel, wood, black, brown
 Hängeleuchte; Stahl, Holz, schwarz, braun
 luminaire en suspension; acier, bois, noir, marron

L 1000, B 45, H 1100



E27 6x 40W



9 002759 433192

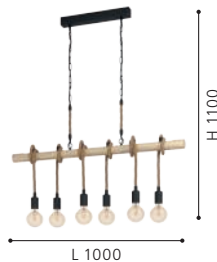

43351 RAMPSIDE 1

wall light; wood, natural / steel, black
 Wandleuchte; Holz, natur / Stahl, schwarz
 applique; bois, naturel / acier, noir

L 140, H 330, A 240



E27 1x 40W



9 002759 433512





49694



43194

49694 FINDLAY

pendant light; steel, black
Hängeleuchte; Stahl, schwarz
luminaire en suspension; acier, noir

H 1500, Ø 560



E27



6x 60W



9 002759 496944

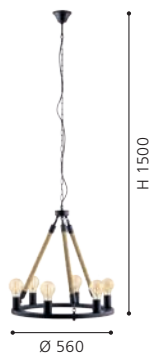

H 1500

Ø 560

43194 RAMPSIDE

pendant light; steel, black
Hängeleuchte; Stahl, schwarz
luminaire en suspension; acier, noir

H 1090, Ø 760



E27



6x 28W



9 002759 431945



H 1090

Ø 760



43195



43256

DETAIL 43195

The luminaire heads can be installed on the ceiling individually.
Die Leuchtenköpfe können individuell an die Decke montiert werden.

Les têtes de luminaires peuvent être montées individuellement au plafond.

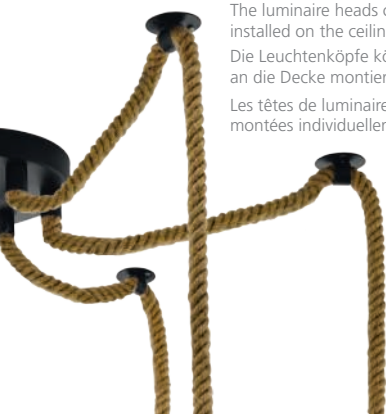

43197

43195 RAMPSIDE

pendant light; steel, black
Hängeleuchte; Stahl, schwarz
luminaire en suspension; acier, noir

H 1590, Ø 180



E27 6x 28W



9 002759 431952

43197 RAMPSIDE

wall light; steel, wood, black, brown
Wandleuchte; Stahl, Holz, schwarz, braun
applique; acier, bois, noir, marron

L 80, H 300, A 135

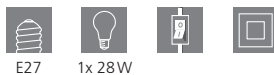

E27 1x 28W



9 002759 431976

43256 RAMPSIDE

pendant light; steel, black
Hängeleuchte; Stahl, schwarz
luminaire en suspension; acier, noir

H 1380, Ø 110



E27 1x 28W



9 002759 432560



43192



43199

43192 RAMPSIDE

pendant light; steel, black / glass vaporized, amber
 Hängeleuchte; Stahl, schwarz / Glas bedampft, amber
 luminaire en suspension; acier, noir / verre vaporisé, ambre

L 895, B 195, H 1230



E27



3x 28W



9 002759 431921



43199 RAMPSIDE

table light; steel, black / fabric, creme
 Tischleuchte; Stahl, schwarz / Textil, creme
 luminaire de table; acier, noir / tissu, crème

H 400, Ø 190, Base: Ø 145



E27



1x 28W



9 002759 431990





43328

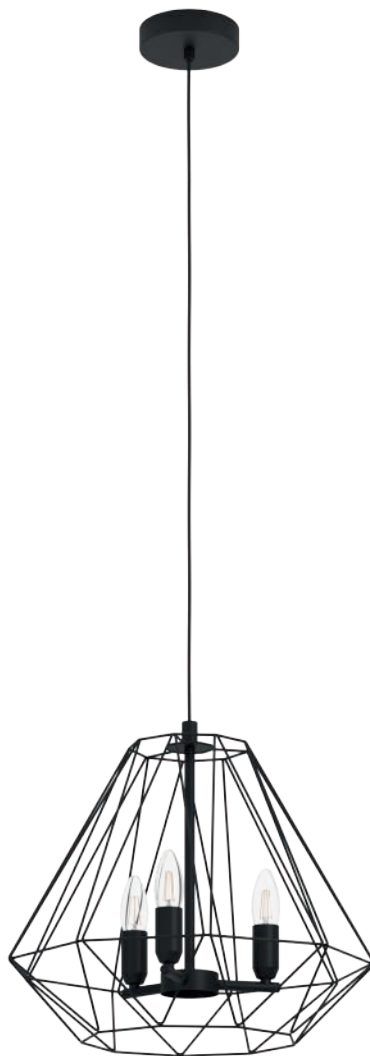

43845

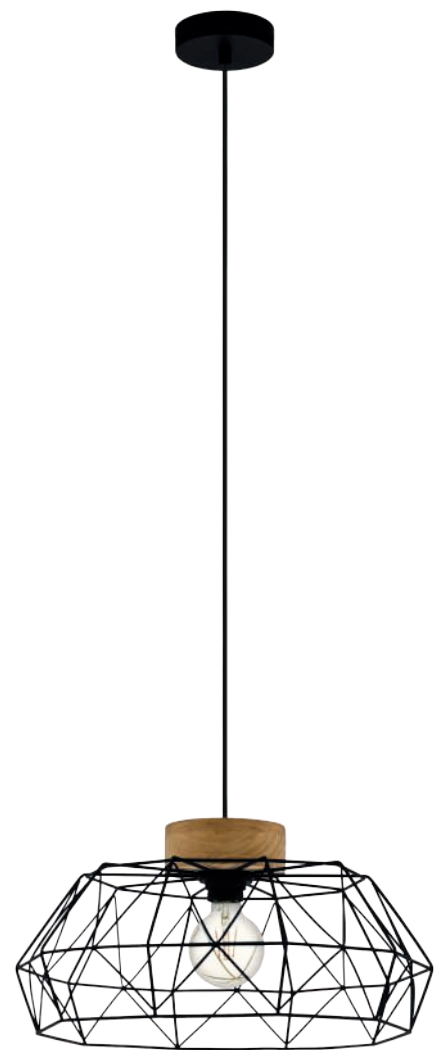

43364

43328 COTTINGHAM

pendant light; steel, black
Hängeleuchte; Stahl, schwarz
luminaire en suspension; acier, noir

H 1100, Ø 370



E27 1x 40W



9 002759 433284

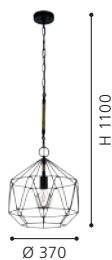

43845 TARLE

pendant light; steel, black
Hängeleuchte; Stahl, schwarz
luminaire en suspension; acier, noir

H 1100, Ø 445



E14 3x 40W



9 002759 438456



43364 PADSTOW

pendant light; steel, wood, black, natural
Hängeleuchte; Stahl, Holz, schwarz, natur
luminaire en suspension; acier, bois, noir, naturel

H 1100, Ø 455



E27 1x 60W



9 002759 433642

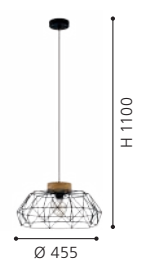



43363



43352

43363 PADSTOW

ceiling light; steel, wood, black, natural
Deckenleuchte; Stahl, Holz, schwarz, natur
plafonnier; acier, bois, noir, naturel

H 205, Ø 455



E27



1x 60W



9 002759 433635



43352 HORNINGTOPS

pendant light; steel, wood, black, natural
Hängeleuchte; Stahl, Holz, schwarz, natur
luminaire en suspension; acier, bois, noir, naturel

L 760, B 150, H 1100



E27



3x 40W



9 002759 433529





43619



43617



43618

43619 RODING

wall light; steel, wood, black, brown / glass, clear
Wandleuchte; Stahl, Holz, schwarz, braun / Glas, klar
applique; acier, bois, noir, marron / verre, transparent

L 180, H 350, A 180



E27



1x 40W



9 002759 436193



43617 RODING

pendant light; steel, wood, black, brown / glass, clear
Hängeleuchte; Stahl, Holz, schwarz, braun / Glas, klar
luminaire en suspension; acier, bois, noir, marron / verre, transparent

H 1100, Ø 180



E27



1x 40W



9 002759 436179



43618 RODING

pendant light; steel, wood, black, brown / glass, clear
Hängeleuchte; Stahl, Holz, schwarz, braun / Glas, klar
luminaire en suspension; acier, bois, noir, marron / verre, transparent

L 880, B 180, H 1100



E27



3x 40W



9 002759 436186





43397



43396



43397 HODSOLL

pendant light; steel, wood, black, brown rustic / steel, black, creme

Hängeleuchte; Stahl, Holz, schwarz, braun rustikal / Stahl, schwarz, creme

luminaire en suspension; acier, bois, noir, marron rustique / acier, noir, crème

L 1250, B 400, H 1100



E27



2x 40W



9 002759 433970



43396 HODSOLL

pendant light; steel, wood, black, brown rustic / steel, black, creme

Hängeleuchte; Stahl, Holz, schwarz, braun rustikal / Stahl, schwarz, creme

luminaire en suspension; acier, bois, noir, marron rustique / acier, noir, crème

L 350, B 400, H 1100



E27



1x 40W



9 002759 433963



DETAIL HODSOLL

The mounting bracket of the light fitting can be individually adjusted.

Die Aufhängung der Leuchtenköpfe kann individuell eingestellt werden.

La suspension des têtes de luminaire est réglable.



43405



43404

43405 CHERTSEY

pendant light; steel, leather, black / steel, zinc-plated
 Hängeleuchte; Stahl, Leder, schwarz / Stahl, verzinkt
 luminaire en suspension; acier, cuir, noir / acier, galvanisé

H 1100, Ø 335



E27



1x 60W



9 002759 434052



43404 MEOPHAM

pendant light; steel, auburn
 Hängeleuchte; Stahl, rostbraun
 luminaire en suspension; acier, brun rouille

H 1100, Ø 240



E27



1x 60W



9 002759 434045



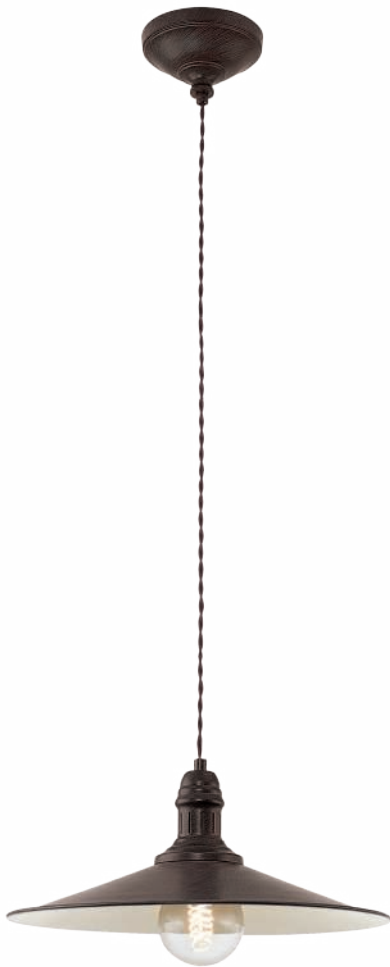

49456



49457



49458

49456 STOCKBURY

pendant light; steel, antique-brown, beige
Hängeleuchte; Stahl, antik-braun, beige
luminaire en suspension; acier, marron antique, beige

H 1100, Ø 360



E27 1x 60W



9 002759 494568

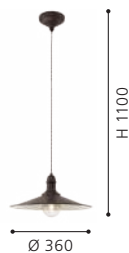

49457 STOCKBURY

pendant light; steel, antique-brown, beige
Hängeleuchte; Stahl, antik-braun, beige
luminaire en suspension; acier, marron antique, beige

L 800, B 300, H 1100



E27 2x 60W



9 002759 494575



49458 STOCKBURY

wall light; steel, antique-brown, beige
Wandleuchte; Stahl, antik-braun, beige
applique; acier, marron antique, beige

L 210, H 225, A 270



E27 1x 60W



9 002759 494582





43322

DETAIL 43322

The canopy design enables the position of the light fitting to be individually adjusted.

Durch den besondern Baldachin ist die Position der Leuchtmittel individuell verstellbar.

Dies ist ein Platzhalter Grâce à son dais spécial, la position de chaque ampoule peut être ajustée.



43322 HOGSMILL

pendant light; steel, black
Hängeleuchte; Stahl, schwarz
luminaire en suspension; acier, noir

L 1155, B 405, H 1100



E27



8x 40W



9 002759 433222

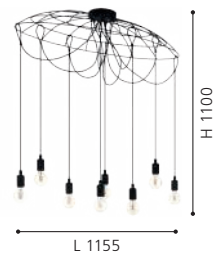

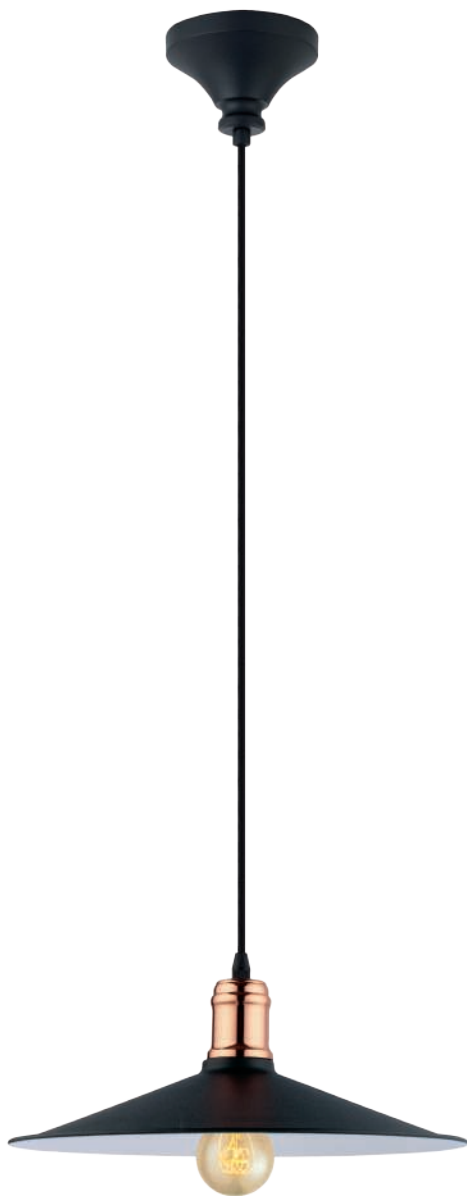

49452

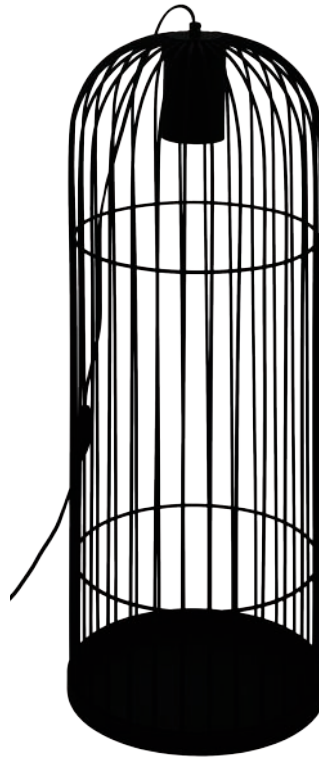

43389



49452 BRIDPORT

pendant light; steel, black, copper
 Hängeleuchte; Stahl, schwarz, kupfer
 luminaire en suspension; acier, noir, cuivre

H 1100, Ø 360



E27



1x 60W



9 002759 494520

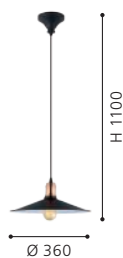

43389 LATCHELY

floor light; steel, black
 Stehleuchte; Stahl, schwarz
 lampadaire; acier, noir

H 720, Ø 275



GU10



1x 4,6W



warm
 WHITE
 1x
 400lm



9 002759 433895

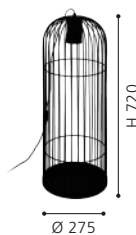

NATURE

Bring the warmth and comfort of natural elements into your home. The back-to-nature trend incorporates designs that use natural materials, harmonious colour combinations, and simple, neutral shapes. A lamp from the EGLO Nature range will increase the comfort of any living space, no matter what interior design style you prefer.

Holen Sie sich pure Gemütlichkeit in Ihr zu Hause, ganz getreu dem Motto „back to nature“. Der Nature-Trend umfasst Designs mit natürlichen Materialien, aufeinander abgestimmten Farbkombinationen und neutralen sowie einfachen Formen. Egal welchen Einrichtungsstil Sie bevorzugen, mit einer EGLO Leuchte aus der Kategorie Nature steigern Sie das Wohlbefinden im Wohnraum.

Faites entrer le confort absolu dans votre maison, fidèle à la devise „retour à la nature“. La tendance nature comprend des designs avec des matériaux naturels, des combinaisons de couleurs coordonnées et des formes neutres et simples. Quel que soit le style d'ameublement que vous préférez, avec une lampe EGLO de la catégorie Nature, vous augmentez le bien-être dans le salon.





This product is available in different colors and shapes./ Dieser Artikel ist in unterschiedlichen Farben und Formen verfügbar.
Cet article est disponible en différentes couleurs et formes.



43785



43786



43784

43784 ALDERNEY

ceiling light; steel, black / textile thread, natural
Deckenleuchte; Stahl, schwarz / Textilfaden, natur
plafonnier; acier, noir / fil textile, nature

H 240, Ø 480



E27



1x 40W



9 002759 437848

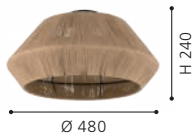

43785 ALDERNEY

pendant light; steel, black / textile thread, natural
Hängeleuchte; Stahl, schwarz / Textilfaden, natur
luminaire en suspension; acier, noir / fil textile, nature

H 1100, Ø 300



E27



1x 40W



9 002759 437855



43786 ALDERNEY

pendant light; steel, black / textile thread, natural
Hängeleuchte; Stahl, schwarz / Textilfaden, natur
luminaire en suspension; acier, noir / fil textile, nature

L 900, B 200, H 1100



E27



3x 40W



9 002759 437862





43775



43777



43776



43775 ADWICKLE

ceiling light; steel, black / fabric, natural
Deckenleuchte; Stahl, schwarz / Textil, natur
plafonnier; acier, noir / tissu, nature

H 260, Ø 445



E27



1x 40W



9 002759 437756



43777 ADWICKLE

pendant light; steel, black / fabric, natural
Hängeleuchte; Stahl, schwarz / Textil, natur
luminaire en suspension; acier, noir / tissu, nature

L 870, B 145, H 1100



E27



3x 40W



9 002759 437770



43776 ADWICKLE

pendant light; steel, black / fabric, natural
Hängeleuchte; Stahl, schwarz / Textil, natur
luminaire en suspension; acier, noir / tissu, nature

L 170, B 145, H 1100



E27



1x 40W



9 002759 437763

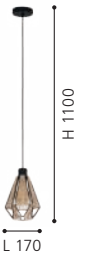

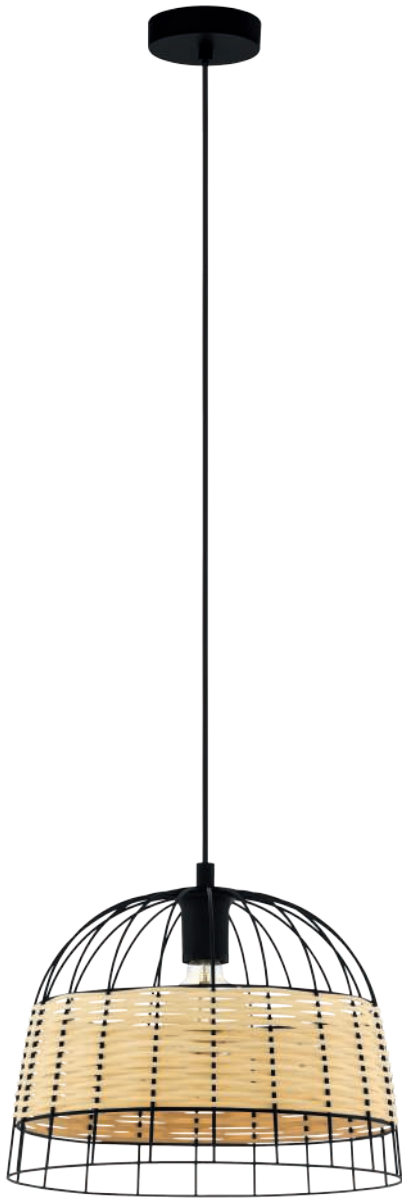

43311



43313

43311 ANWICK

pendant light; steel, black / rattan, natural
 Hängeleuchte; Stahl, schwarz / Rattan, natur
 luminaire en suspension; acier, noir / rotin, nature

H 1100, Ø 370



E27 1x 40W



9 002759 433116



43313 ANWICK

pendant light; steel, black / rattan, natural
 Hängeleuchte; Stahl, schwarz / Rattan, natur
 luminaire en suspension; acier, noir / rotin, nature

L 880, B 180, H 1100



E27 3x 40W



9 002759 433130





43398



43312



43398 ANWICK

ceiling light; steel, black / rattan, natural
Deckenleuchte; Stahl, schwarz / Rattan, natur
plafonnier; acier, noir / rotin, nature

H 265, Ø 380



E27



1x 60W



9 002759 433987

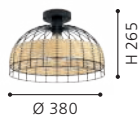

43312 ANWICK

pendant light; steel, black / rattan, natural
Hängeleuchte; Stahl, schwarz / Rattan, natur
luminaire en suspension; acier, noir / rotin, nature

H 1100, Ø 500



E27



1x 40W



9 002759 433123





43325 ANWICK 1

spot; steel, black / rattan, natural
 Spot; Stahl, schwarz / Rattan, natur
 spot; acier, noir / rotin, nature

L 480, B 140, H 240



E27



2x 40W



9 002759 433253

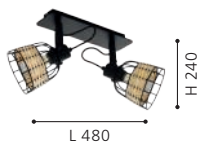

43326 ANWICK 1

spot; steel, black / rattan, natural
 Spot; Stahl, schwarz / Rattan, natur
 spot; acier, noir / rotin, nature

L 670, B 140, H 240



E27



3x 40W



9 002759 433260



43324 ANWICK 1

spot; steel, black / rattan, natural
 Spot; Stahl, schwarz / Rattan, natur
 spot; acier, noir / rotin, nature

L 140, H 200



E27



1x 40W



9 002759 433246

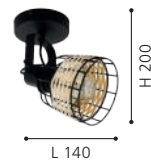



43324





43851



43854



43853

43851 HYKEHAM

ceiling light; steel, black / wood, natural
Deckenleuchte; Stahl, schwarz / Holz, natur
plafonnier; acier, noir / bois, nature

H 210, Ø 380



E27 1x 40W



9 002759 438517

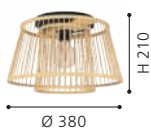

43854 HYKEHAM

table light; steel, black / wood, natural
Tischleuchte; Stahl, schwarz / Holz, natur
luminaire de table; acier, noir / bois, nature

H 570, Ø 210, Base: Ø 285



E27 1x 40W



9 002759 438548



43853 HYKEHAM

pendant light; steel, black / wood, natural
Hängeleuchte; Stahl, schwarz / Holz, natur
luminaire en suspension; acier, noir / bois, nature

L 910, B 210, H 1100



E27 3x 40W



9 002759 438531





43855



43852

43855 HYKEHAM

floor light; steel, black / wood, natural
 Stehleuchte; Stahl, schwarz / Holz, natur
 lampadaire; acier, noir / bois, nature

H 1295, Ø 380, Base: Ø 630



E27



1x 40W



9 002759 438555

43852 HYKEHAM

pendant light; steel, black / wood, natural
 Hängeleuchte; Stahl, schwarz / Holz, natur
 luminaire en suspension; acier, noir / bois, nature

H 1100, Ø 380



E27



1x 40W



9 002759 438524



43216



43231



43218

43216 BORDESLEY

pendant light; steel, black / wood, natural
Hängeleuchte; Stahl, schwarz / Holz, natur
luminaire en suspension; acier, noir / bois, nature

H 1100, Ø 350



E27 1x 28W



9 002759 432164



43231 BORDESLEY

pendant light; steel, black / wood, natural
Hängeleuchte; Stahl, schwarz / Holz, natur
luminaire en suspension; acier, noir / bois, nature

H 1100, Ø 210



E27 1x 28W



9 002759 432317



43218 BORDESLEY

table light; steel, black / wood, natural
Tischleuchte; Stahl, schwarz / Holz, natur
luminaire de table; acier, noir / bois, nature

H 400, Ø 210, Base: Ø 190



E27 1x 28W



9 002759 432188





43217

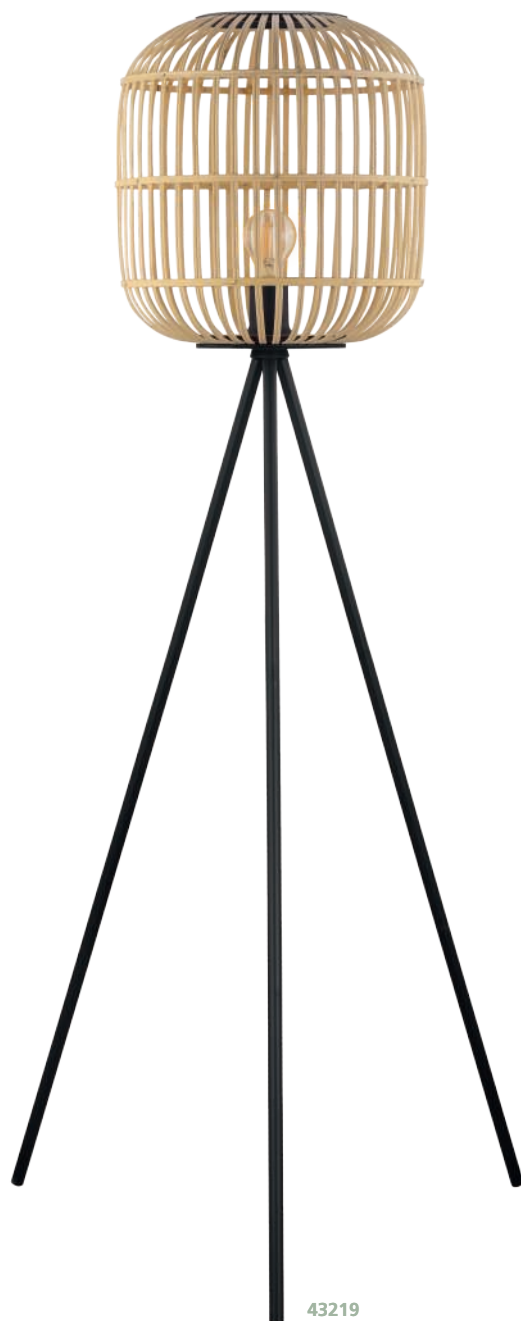

43219

43217 BORDESLEY

pendant light; steel, black / wood, natural
 Hängeleuchte; Stahl, schwarz / Holz, natur
 luminaire en suspension; acier, noir / bois, nature

L 910, B 210, H 1100



E27



3x 28W



9 002759 432171

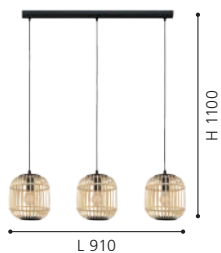

43219 BORDESLEY

floor light; steel, black / wood, natural
 Stehleuchte; Stahl, schwarz / Holz, natur
 lampadaire; acier, noir / bois, nature

H 1390, Ø 350, Base: Ø 820



E27



1x 28W



9 002759 432195





43872

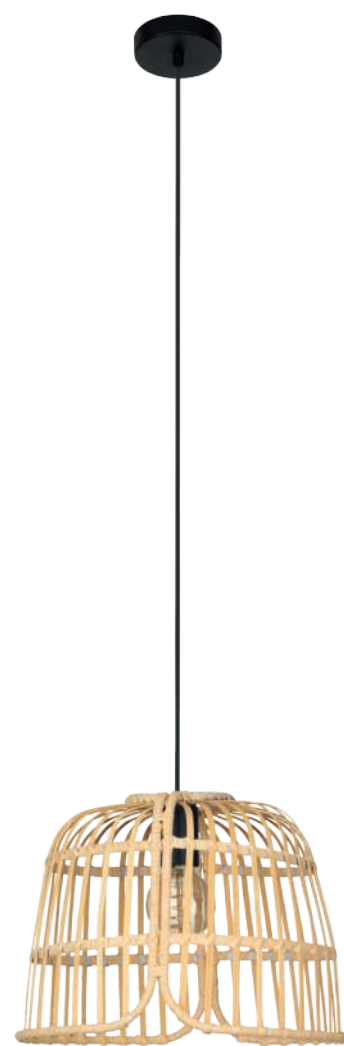

43873

43872 GLYNEATH

ceiling light; steel, black / wood, natural
Deckenleuchte; Stahl, schwarz / Holz, natur
plafonnier; acier, noir / bois, nature

H 205, Ø 375



E27



1x 40W



9 002759 438722



43873 GLYNEATH

pendant light; steel, black / wood, natural
Hängeleuchte; Stahl, schwarz / Holz, natur
luminaire en suspension; acier, noir / bois, nature

H 1100, Ø 375



E27



1x 40W



9 002759 438739





43831



43285

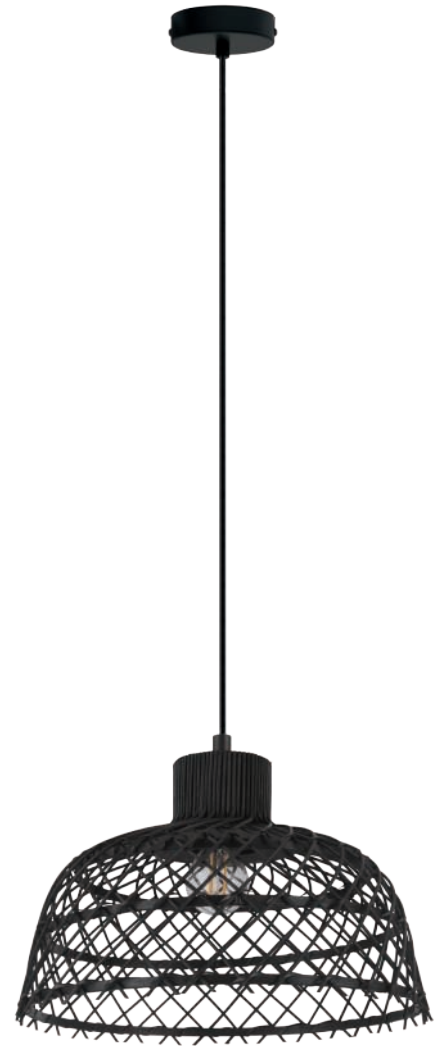

43288

43831 AUSNBY

ceiling light; steel, black / wood, natural
Deckenleuchte; Stahl, schwarz / Holz, natur
plafonnier; acier, noir / bois, nature

H 200, Ø 370



E27



1x 40W



9 002759 438319

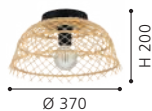

43285 AUSNBY

pendant light; steel, black / wood, natural
Hängeleuchte; Stahl, schwarz / Holz, natur
luminaire en suspension; acier, noir / bois, nature

H 1100, Ø 370



E27



1x 40W



9 002759 432850



43288 AUSNBY

pendant light; steel, black / wood, black
Hängeleuchte; Stahl, schwarz / Holz, schwarz
luminaire en suspension; acier, noir / bois, noir

H 1100, Ø 370



E27



1x 40W



9 002759 432881





43266

43266 DEMBLEBY 1

pendant light; steel, black / wood, black
 Hängeleuchte; Stahl, schwarz / Holz, schwarz
 luminaire en suspension; acier, noir / bois, noir

L 900, B 200, H 1100



E27



3x 40W



9 002759 432669

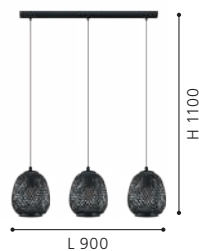

43265 DEMBLEBY 1

pendant light; steel, black / wood, black
 Hängeleuchte; Stahl, schwarz / Holz, schwarz
 luminaire en suspension; acier, noir / bois, noir

H 1100, Ø 320



E27



1x 40W



9 002759 432652





43265





43262



43263

43262 DEMBLEBY

pendant light; steel, black / wood, natural
 Hängeleuchte; Stahl, schwarz / Holz, natur
 luminaire en suspension; acier, noir / bois, nature

L 900, B 200, H 1100



E27



3x 40W



9 002759 432621



43263 DEMBLEBY

table light; steel, black / wood, natural
 Tischleuchte; Stahl, schwarz / Holz, natur
 luminaire de table; acier, noir / bois, nature

H 250, Ø 200, Base: Ø 115



E27



1x 40W



9 002759 432638



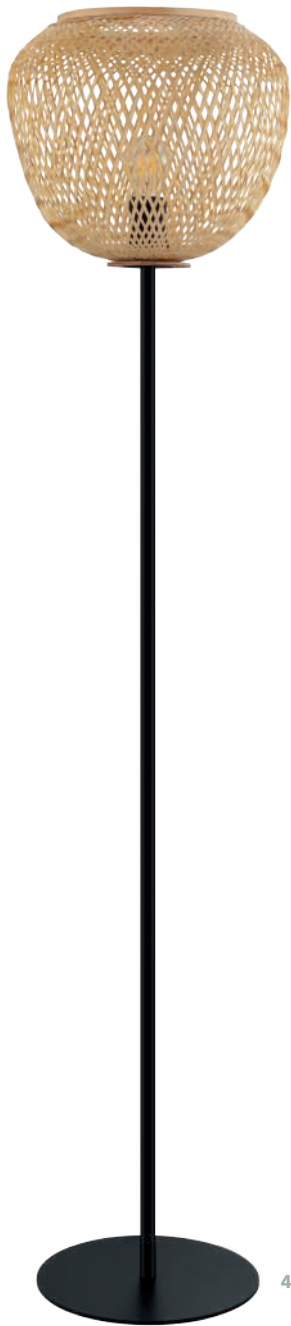

43264



43261

43264 DEMBLEBY

floor light; steel, black / wood, natural
 Stehleuchte; Stahl, schwarz / Holz, natur
 lampadaire; acier, noir / bois, nature

H 1500, Ø 320, Base: Ø 275



E27 1x 40W



9 002759 432645



43261 DEMBLEBY

pendant light; steel, black / wood, natural
 Hängeleuchte; Stahl, schwarz / Holz, natur
 luminaire en suspension; acier, noir / bois, nature

H 1100, Ø 320



E27 1x 40W



9 002759 432614





43253



43252

43254

43253 CLAVERDON

pendant light; steel, black / wood, natural
Hängeleuchte; Stahl, schwarz / Holz, natur
luminaire en suspension; acier, noir / bois, nature

H 1100, Ø 370



E27 1x 40W



9 002759 432539



43254 CLAVERDON

pendant light; steel, black / wood, natural
Hängeleuchte; Stahl, schwarz / Holz, natur
luminaire en suspension; acier, noir / bois, nature

H 1100, Ø 495



E27 1x 40W



9 002759 432546



43252 CLAVERDON

pendant light; steel, black / wood, natural
Hängeleuchte; Stahl, schwarz / Holz, natur
luminaire en suspension; acier, noir / bois, nature

H 1100, Ø 180



E27 1x 40W



9 002759 432522





43255



43251

DETAIL 43255

The luminaire heads can be installed on the ceiling individually.
Die Leuchtenköpfe können individuell an die Decke montiert werden.
Les têtes de luminaires peuvent être montées individuellement au plafond.

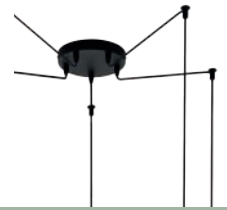

43255 CLAVERDON

pendant light; steel, black / wood, natural
Hängeleuchte; Stahl, schwarz / Holz, natur
luminaire en suspension; acier, noir / bois, nature

H 2000, Ø 180



E27



5x 40W



9 002759 432553



H 2000

43251 CLAVERDON

ceiling light; steel, black / wood, natural
Deckenleuchte; Stahl, schwarz / Holz, natur
plafonnier; acier, noir / bois, nature

H 245, Ø 370



E27



1x 40W



9 002759 432515

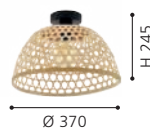

H 245

Ø 370



43866



43867

43866 AYESGARTH

pendant light; steel, black / wood, natural
 Hängeleuchte; Stahl, schwarz / Holz, natur
 luminaire en suspension; acier, noir / bois, nature

H 1100, Ø 330



E27



1x 40W



9 002759 438661



43867 AYESGARTH

pendant light; steel, black / wood, natural
 Hängeleuchte; Stahl, schwarz / Holz, natur
 luminaire en suspension; acier, noir / bois, nature

L 910, B 210, H 1100



E27



3x 40W



9 002759 438678





49772



43723



49771

49772 AMSFIELD

pendant light; steel, brown / wood, brown
 Hängeleuchte; Stahl, braun / Holz, braun
 luminaire en suspension; acier, marron / bois, marron

H 1100, Ø 350



E27



1x 60W



9 002759 497729



43723 AMSFIELD

ceiling light; steel, black / wood, brown
 Deckenleuchte; Stahl, schwarz / Holz, braun
 plafonnier; acier, noir / bois, marron

H 285, Ø 450



E27



1x 40W



9 002759 437237

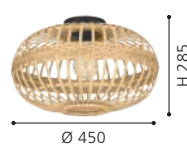

49771 AMSFIELD

pendant light; steel, brown / wood, brown
 Hängeleuchte; Stahl, braun / Holz, braun
 luminaire en suspension; acier, marron / bois, marron

H 1100, Ø 380



E27



1x 60W



9 002759 497712





43113

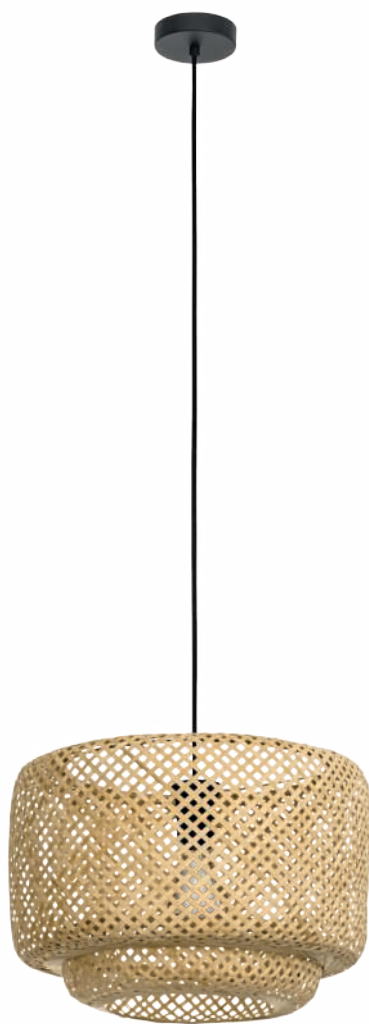

43868

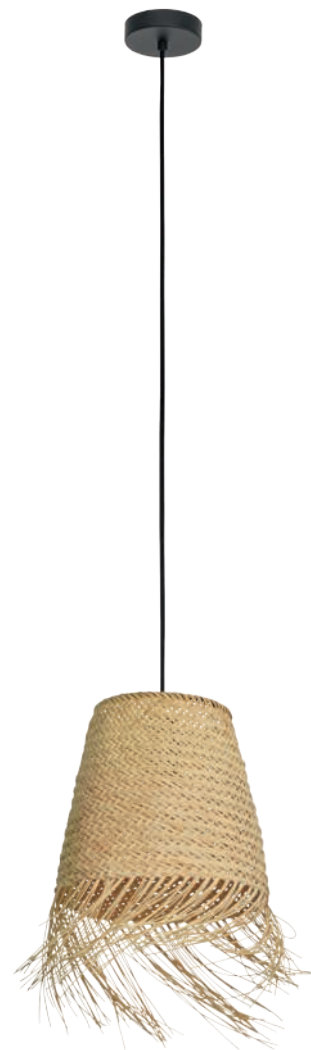

43871

43113 KIRKCOLM

pendant light; steel, satin nickel / wood, natural
 Hängeleuchte; Stahl, nickel-matt / Holz, natur
 luminaire en suspension; acier, nickel mat / bois, nature

H 1100, Ø 300



E27 1x 60W



9 002759 431136



Ø 300

43868 HETTONLE

pendant light; steel, black / wood, natural
 Hängeleuchte; Stahl, schwarz / Holz, natur
 luminaire en suspension; acier, noir / bois, nature

H 1100, Ø 420



E27 1x 40W



9 002759 438685



Ø 420

43871 AYCLIFFE

pendant light; steel, black / wood, natural
 Hängeleuchte; Stahl, schwarz / Holz, natur
 luminaire en suspension; acier, noir / bois, nature

H 1100, Ø 300



E27 1x 40W



9 002759 438715

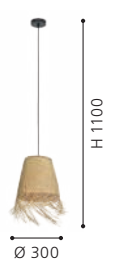

Ø 300

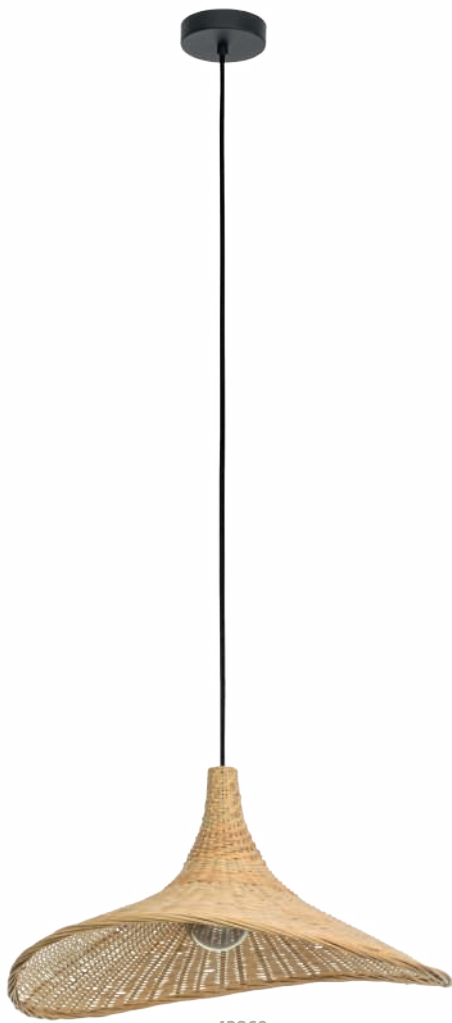

43869



43874

43869 HAXEY

pendant light; steel, black / wood, natural
 Hängeleuchte; Stahl, schwarz / Holz, natur
 luminaire en suspension; acier, noir / bois, nature

H 1100, Ø 500



E27



1x 40W



9 002759 438692

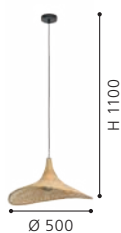

43874 SURFLEET

pendant light; steel, wood, black, brown / fabric, linen, natural
 Hängeleuchte; Stahl, Holz, schwarz, braun / Textil, Leinen, natur
 luminaire en suspension; acier, bois, noir, marron / tissu, lin, nature

H 1100, Ø 330



E27



1x 40W



9 002759 438746



COTTAGE CHIC

It's tea o'clock – the famous tea time shouldn't be limited to Brits. Interrupt the rhythm of your day, take a deep breath and enjoy a few moments of calm. It will feel so good! Best do it with a cup of tea in a British-style atmosphere, glass, crystal, flower patterns and luminaires that are presented as decorative pieces. EGLO will bring a piece of British Cottage Chic to your home without having to travel at all.

It's tea o'clock – die berühmte Teepause sollten sich nicht nur die Briten gönnen. Unterbrechen Sie Ihren Tagesrhythmus, atmen Sie tief durch und genießen Sie ein paar Momente der Stille. Wie gut das tut! Am besten in britisch angehauchter Atmosphäre mit einer Tasse Tee in der Hand. Keramik, Glas, Kristall, Blümchendekor und Leuchten, die sich als Dekostücke präsentieren. Ohne Reisen erhalten Sie mit EGLO ein Stück britischen Cottage Chics für Ihr Zuhause.

It's tea o'clock (Il est l'heure du thé) – la célèbre pause thé ne doit pas uniquement être destiné aux britanniques. Interrompez votre rythme quotidien, respirez profondément et régalez-vous de quelques instants de silence. Combien de bien cela peut faire ! Le mieux serait de faire cela dans une atmosphère à inspiration britannique, ayant une tasse de thé à la main. De la céramique, du verre, du Crystal, des décorations à fleurs et des luminaires, se présentant en tant que pièces décoratives. Grâce à EGLO, vous obtenez un peu de Cottage Chics britannique pour votre maison, sans même devoir voyager.





EDALE
p. 242



ARNHEM
p. 244-245, 246



MEDIOUNA
p. 246



BRADFORD
p. 248-249



BRADFORD 1
p. 249



KENSAL
p. 250



NIMLET
p. 251



KINROSS
p. 252



HAMBLETON
p. 252



CAPOSILE
p. 252



TOWNSHEND 2
p. 253



This product is available in different colors and shapes./ Dieser Artikel ist in unterschiedlichen Farben und Formen verfügbar.
Cet article est disponible en différentes couleurs et formes.



43783



43782



43783 EDALE

wall light; steel, wood, black, brown / fabric, cappuccino
Wandleuchte; Stahl, Holz, schwarz, braun / Textil, cappuccino
applique; acier, bois, noir, marron / tissu, cappuccino

L 150, H 215, A 195



E27



1x 40W



9 002759 437831



43782 EDALE

pendant light; steel, wood, black, brown / fabric, cappuccino
Hängeleuchte; Stahl, Holz, schwarz, braun / Textil, cappuccino
luminaire en suspension; acier, bois, noir, marron / tissu, cappuccino

L 1080, B 510, H 1100



E27



6x 40W



9 002759 437824



43781 EDALE

pendant light; steel, wood, black, brown / fabric, cappuccino
Hängeleuchte; Stahl, Holz, schwarz, braun / Textil, cappuccino
luminaire en suspension; acier, bois, noir, marron / tissu, cappuccino

H 1100, Ø 700



E27



6x 40W



9 002759 437817

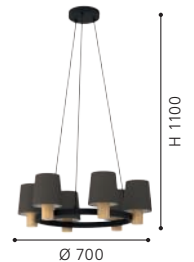



43781





43401



43402



DETAIL 43403

The luminaire heads can be installed on the ceiling individually.
Die Leuchtenköpfe können individuell an die Decke montiert werden.
Les têtes de luminaires peuvent être montées individuellement au plafond.

43401 ARNHEM

pendant light; steel, white / paper, seagrass, white, brown
Hängeleuchte; Stahl, weiss / Papier, Seegrass, weiss, braun
luminaire en suspension; acier, blanc / papier, en jonc de mer, blanc, marron

H 1100, Ø 240



E27 1x 40W



9 002759 434014



43402 ARNHEM

pendant light; steel, white / paper, seagrass, white, brown
Hängeleuchte; Stahl, weiss / Papier, Seegrass, weiss, braun
luminaire en suspension; acier, blanc / papier, en jonc de mer, blanc, marron

L 1020, B 240, H 1100



E27 3x 40W



9 002759 434021



43403 ARNHEM

pendant light; steel, white / paper, seagrass, white, brown
Hängeleuchte; Stahl, weiss / Papier, Seegrass, weiss, braun
luminaire en suspension; acier, blanc / papier, en jonc de mer, blanc, marron

H 1300, Ø 960



E27 3x 40W



9 002759 434038





43403



43555



43556

43555 ARNHEM

table light; steel, white / paper, seagrass, white, brown
Tischleuchte; Stahl, weiss / Papier, Seegrass, weiss, braun
luminaire de table; acier, blanc / papier, en jonc de mer, blanc, marron

H 610, Ø 240, Base: Ø 290



E27 1x 40W



9 002759 435554



43556 ARNHEM

floor light; steel, white / paper, seagrass, white, brown
Stehleuchte; Stahl, weiss / Papier, Seegrass, weiss, braun
lampadaire; acier, blanc / papier, en jonc de mer, blanc, marron

H 1510, Ø 440, Base: Ø 750



E27 1x 40W



9 002759 435561



43393 MEDIOUNA

pendant light; steel, beige / glass vaporized, seagrass, gold color, brown

Hängeleuchte; Stahl, beige / Glas bedampft, Seegrass, goldfarben, braun

luminaire en suspension; acier, beige / verre vaporisé, en jonc de mer, doré, marron

H 1100, Ø 230



E27 1x 40W



9 002759 433932





43393



49214



49284



49213

49214 BRADFORD

pendant light; steel, silver-antique / glass, clear
Hängeleuchte; Stahl, silber-antik / Glas, klar
luminaire en suspension; acier, argent antique / verre, transparent

H 1100, Ø 140



E27 1x 60W



9 002759 492144

49284 BRADFORD

table light; steel, silver-antique / glass, clear
Tischleuchte; Stahl, silber-antik / Glas, klar
luminaire de table; acier, argent antique / verre, transparent

H 330, Ø 140



E27 1x 60W



9 002759 492847

49213 BRADFORD

pendant light; steel, black / glass, clear
Hängeleuchte; Stahl, schwarz / Glas, klar
luminaire en suspension; acier, noir / verre, transparent

H 1100, Ø 140



E27 1x 60W



9 002759 492137



49283



43624



43623

49283 BRADFORD

table light; steel, black / glass, clear
Tischleuchte; Stahl, schwarz / Glas, klar
luminaire de table; acier, noir / verre, transparent

H 330, Ø 140



E27 1x 60W



9 002759 492830



43624 BRADFORD 1

table light; steel, black / glass, clear
Tischleuchte; Stahl, schwarz / Glas, klar
luminaire de table; acier, noir / verre, transparent

L 150, B 150, H 405

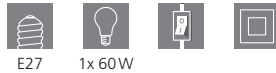

E27 1x 60W



9 002759 436247



43623 BRADFORD 1

table light; steel, black / glass, clear
Tischleuchte; Stahl, schwarz / Glas, klar
luminaire de table; acier, noir / verre, transparent

L 165, B 150, H 370



E27 1x 60W



9 002759 436230





43642

43642 KENSAL

table light; steel, grey, black / fabric, black
Tischleuchte; Stahl, grau, schwarz / Textil, schwarz
luminaire de table; acier, gris, noir / tissu, noir

H 435, Ø 250, Base: Ø 140



E27



1x 40W



9 002759 436421





43653



43652

43653 NIMLET

table light; steel, black / fabric, black
 Tischleuchte; Stahl, schwarz / Textil, schwarz
 luminaire de table; acier, noir / tissu, noir

H 515, Ø 300, Base: Ø 135



E27



1x 40W



9 002759 436537



43652 NIMLET

table light; steel, black / fabric, white
 Tischleuchte; Stahl, schwarz / Textil, weiss
 luminaire de table; acier, noir / tissu, blanc

H 515, Ø 300, Base: Ø 135



E27



1x 40W



9 002759 436520





49724



49489



49851

49724 KINROSS

pendant light; steel, brown / wood, brown
Hängeleuchte; Stahl, braun / Holz, braun
luminaire en suspension; acier, marron / bois, marron

H 1100, Ø 310



E27 1x 60W



9 002759 497248



49489 HAMBLETON

pendant light; steel, satin nickel / steel, white
Hängeleuchte; Stahl, nickel-matt / Stahl, weiss
luminaire en suspension; acier, nickel mat / acier, blanc

H 1100, Ø 350



E27 1x 60W



9 002759 494896



49851 CAPOSILE

pendant light; steel, white
Hängeleuchte; Stahl, weiss
luminaire en suspension; acier, blanc

H 1100, Ø 545

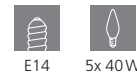

E14 5x 40W



9 002759 498511

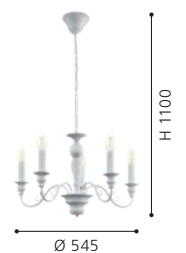



49927

49927 TOWNSHEND 2

pendant light; steel, wood, white-patina / fabric, linen, white, brown

Hängeleuchte; Stahl, Holz, weiss-patina / Textil, Leinen, weiss, braun

luminaire en suspension; acier, bois, blanc patiné / tissu, lin, blanc, marron

L 1000, B 150, H 1100



E27



4x 60W



9 002759 499273

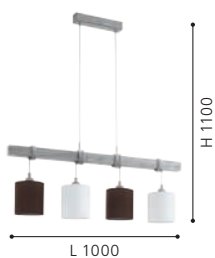

ETHNO ELEGANCE

A little Orient, a bit of Africa, a touch of Latin America – but nothing common at all! These lamps let you dive into a world of exotic markets with spices, colours and shapes. Bring fairy-tale moments from remote countries to your home – with Ethno Elegance.

Ein bisschen Orient, ein wenig Afrika, ein Hauch Lateinamerika – nur nichts Gewöhnliches! Mit diesen Leuchten tauchen Sie ein in eine Welt exotischer Märkte mit Gewürzen, Farben und Formen. Holen Sie märchenhafte Momente aus fernen Ländern zu sich nach Hause – mit Ethno Elegance.

Un peu oriental, un peu africain, une touche d'Amérique latine – surtout rien d'ordinaire ! Grâce à ces luminaires, vous entrez dans un monde de marchés exotiques avec des épices, des couleurs et des formes. Apportez des moments féeriques dans votre maison, venant de pays lointains – grâce à Ethno Elegance.





BRIDEKIRK
p. 256



COULSDON
p. 256



STAVERTON
p. 257



SAFI
p. 258



MELILLA
p. 260



TALBOT 2
p. 260



TAMALLAT
p. 261



STEELEVILLE
p. 263



JADIDA
p. 263



CARDIGAN
p. 264



SUDBURY
p. 265



TALBOT
p. 265



This product is available in different colors and shapes./ Dieser Artikel ist in unterschiedlichen Farben und Formen verfügbar.
Cet article est disponible en différentes couleurs et formes.



43292



43314

43292 BRIDEKIRK

pendant light; steel, black / fabric, linen, natural
Hängeleuchte; Stahl, schwarz / Textil, Leinen, natur
luminaire en suspension; acier, noir / tissu, lin, nature

H 1100, Ø 400



E27



1x 40W



9 002759 432928



43314 COULSDON

pendant light; steel, black / film, black, white
Hängeleuchte; Stahl, schwarz / Folie, schwarz, weiss
luminaire en suspension; acier, noir / film, noir, blanc

H 1310, Ø 145



E27



5x 10W



9 002759 433147





32469



43344



DETAIL 43314

The luminaire heads can be installed in 2 ways on the ceiling.
Die Leuchtenköpfe können auf 2 Arten an die Decke montiert werden.
Les têtes de luminaire peuvent être montées de 2 manières au plafond.

32469 STAVERTON

ceiling light; steel, black
Deckenleuchte; Stahl, schwarz
plafonnier; acier, noir

H 250, Ø 365



E27



1x 60W



9 002759 324698

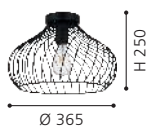

43344 STAVERTON

pendant light; steel, black
Hängeleuchte; Stahl, schwarz
luminaire en suspension; acier, noir

H 1100, Ø 365



E27



1x 60W



9 002759 433444

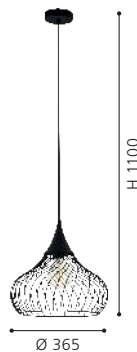



49815



49871

49815 SAFI

pendant light; steel, brown, gold
 Hängeleuchte; Stahl, braun, gold
 luminaire en suspension; acier, marron, or

H 2000, Ø 405



9 002759 498153

49871 SAFI

pendant light; steel, brown, gold
 Hängeleuchte; Stahl, braun, gold
 luminaire en suspension; acier, marron, or

L 700, B 160, H 1100



9 002759 498719

49814 SAFI

pendant light; steel, brown, gold
 Hängeleuchte; Stahl, braun, gold
 luminaire en suspension; acier, marron, or

H 1100, Ø 275



9 002759 498146



49814



49768

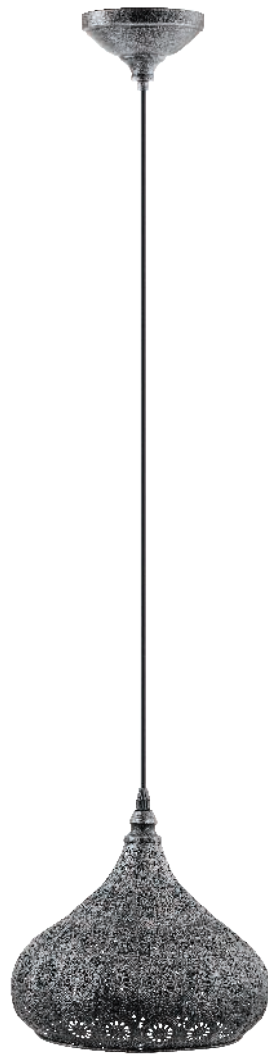

49714

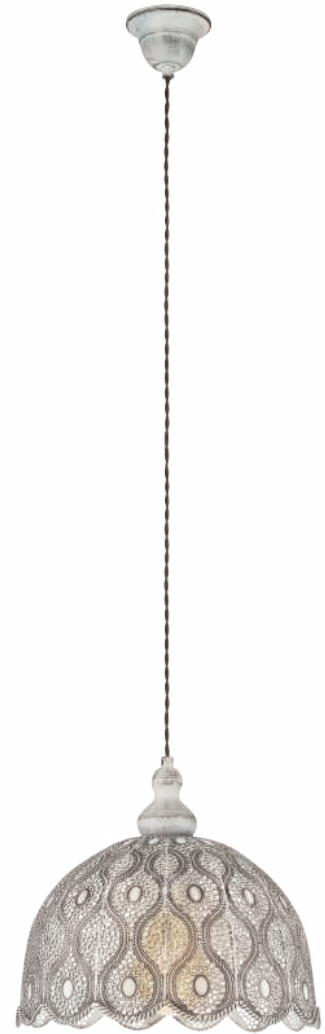

49717

49768 MELILLA

pendant light; steel, gold
Hängeleuchte; Stahl, gold
luminaire en suspension; acier, or

H 1100, Ø 330



E27



1x 60W



9 002759 497682



49714 MELILLA

pendant light; steel, silver-antique
Hängeleuchte; Stahl, silber-antik
luminaire en suspension; acier, argent antique

H 1100, Ø 285



E27



1x 60W



9 002759 497149

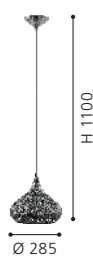

49717 TALBOT 2

pendant light; steel, white-antique
Hängeleuchte; Stahl, weiss-antik
luminaire en suspension; acier, blanc antique

H 1100, Ø 295



E27



1x 60W



9 002759 497170



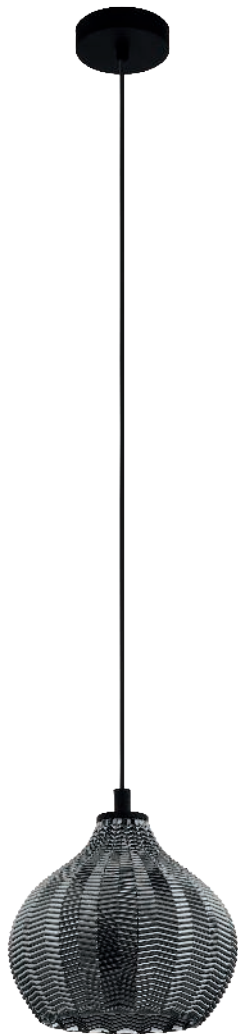

43576



43577

43576 TAMALLAT

pendant light; steel, black / glass vaporized, black-transparent
 Hängeleuchte; Stahl, schwarz / Glas bedampft, schwarz-transparent
 luminaire en suspension; acier, noir / verre vaporisé, noir transparent

H 1100, Ø 230



E27



1x 40W



9 002759 435769



43577 TAMALLAT

pendant light; steel, black / glass vaporized, black-transparent
 Hängeleuchte; Stahl, schwarz / Glas bedampft, schwarz-transparent
 luminaire en suspension; acier, noir / verre vaporisé, noir transparent

L 1050, B 230, H 1100



E27



3x 40W



9 002759 435776



DESIGN
HIGHLIGHT
DETAIL





43587



49764



49765

43587 STEELEVILLE

pendant light; steel, brown-patina, white / crystal glass, black-transparent

Hängeleuchte; Stahl, braun-patina, weiss / Kristallglas, schwarz-transparent

luminaire en suspension; acier, marron patiné, blanc / verre cristal, noir transparent

H 1200, Ø 410



E27



1x 40W



9 002759 435875



49764 JADIDA

pendant light; steel, copper-coloured antique / glass, coloured

Hängeleuchte; Stahl, kupferfarben-antik / Glas, bunt

luminaire en suspension; acier, cuivré antique / verre, coloré

H 1100, Ø 330



E27



1x 60W



9 002759 497644



49765 JADIDA

pendant light; steel, copper-coloured antique / glass, coloured

Hängeleuchte; Stahl, kupferfarben-antik / Glas, bunt

luminaire en suspension; acier, cuivré antique / verre, coloré

H 1100, Ø 220



E27



1x 60W



9 002759 497651

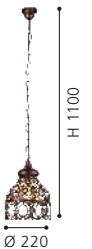



49201



49202



49274

49201 CARDIGAN

pendant light; steel, brown-patina / glass, clear
Hängeleuchte; Stahl, braun-patina / Glas, klar
luminaire en suspension; acier, marron patiné / verre, transparent

H 1100, Ø 120



E27



1x 60W



9 002759 492014



49202 CARDIGAN

pendant light; steel, grey-blue / glass, clear
Hängeleuchte; Stahl, grau-blau / Glas, klar
luminaire en suspension; acier, gris-bleu / verre, transparent

H 1100, Ø 120



E27



1x 60W



9 002759 492021

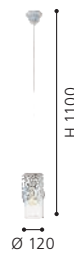

49274 CARDIGAN

table light; steel, brown-patina / glass, clear
Tischleuchte; Stahl, braun-patina / Glas, klar
luminaire de table; acier, marron patiné / verre, transparent

H 265, Ø 120



E27



1x 60W



9 002759 492748





49221



49276

49221 SUDBURY

pendant light; steel, white-patina / glass, clear
 Hängeleuchte; Stahl, weiss-patina / Glas, klar
 luminaire en suspension; acier, blanc patiné / verre, transparent

H 1100, Ø 170



E27



1x 60W



9 1002759 492212

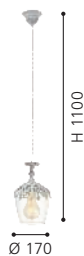

49276 TALBOT

table light; steel, black-patina
 Tischleuchte; Stahl, schwarz-patina
 luminaire de table; acier, noir patiné

H 340, Ø 170



E27



1x 60W



9 1002759 492762



SOCKETS

Minimalism at its best! The SOCKET series by EGLO comes in a variety of styles: from a discreet brass ring attachment to a gritty industrial finish. The most important thing is to choose the best light source to skilfully present the luminaire in its best light.

Minimalismus pur! So präsentiert sich die SOCKET-Serie von EGLO in verschiedenen Stilen: Ob mit dezentem Messingring oder grober Industrial-Haptik. Wichtig bleibt dabei die Wahl des richtigen Leuchtmittels, um die Fassung gekonnt in Szene zu setzen.

Le minimalisme à l'état pur ! Voici comment se présente la série SOCKET d'EGLO dans différents styles : avec un discret anneau en laiton ou une structure rugueuse à l'esprit industriel. L'essentiel est de bien choisir l'ampoule afin de mettre habilement la douille en valeur.





CRANLEY
p. 268



YORTH
p. 269, 271



CALARI
p. 270



This product is available in different colors and shapes./ Dieser Artikel ist in unterschiedlichen Farben und Formen verfügbar.
Cet article est disponible en différentes couleurs et formes.



DESIGN
HIGHLIGHT
DETAIL

43758 CRANLEY

floor light; steel, black
Stehleuchte; Stahl, schwarz
lampadaire; acier, noir

L 430, B 60, H 1700, Base: Ø 300



E27



1x 40W



9 002759 437589



43758

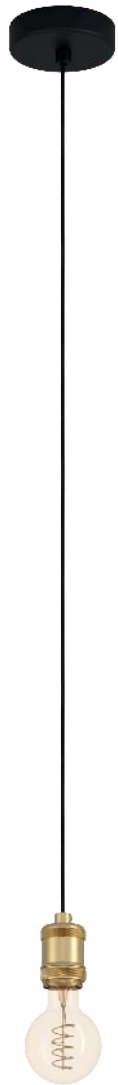

43803



43802



43801



DESIGN
HIGHLIGHT
DETAIL

43803 YORTH

pendant light; steel, black, bronzed
Hängeleuchte; Stahl, schwarz, brüniert
luminaire en suspension; acier, noir, brun

H 1500, Ø 50



E27 1x 40W



9 002759 438036



43802 YORTH

pendant light; steel, black, silver
Hängeleuchte; Stahl, schwarz, silber
luminaire en suspension; acier, noir, argent

H 1500, Ø 50



E27 1x 40W



9 002759 438029



43801 YORTH

pendant light; steel, nickel-nero, black
Hängeleuchte; Stahl, nickel-nero, schwarz
luminaire en suspension; acier, nickel brillant, noir

H 1500, Ø 50



E27 1x 40W



9 002759 438012





31075



31073

31075 CALARI

pendant light; steel, black, brass
Hängeleuchte; Stahl, schwarz, messing
luminaire en suspension; acier, noir, laiton

H 1500, Ø 45



E27



1x 40W



9 002759 310752



31073 CALARI

pendant light; steel, black
Hängeleuchte; Stahl, schwarz
luminaire en suspension; acier, noir

L 95, B 65, H 1500



E27



1x 40W



9 002759 310738





32522



32539



32531

32522 YORTH

pendant light; steel, satin nickel
Hängeleuchte; Stahl, nickel-matt
luminaire en suspension; acier, nickel mat

H 2000, Ø 100



E27



1x 60W



9 002759 325220



32539 YORTH

pendant light; steel, brushed copper
Hängeleuchte; Stahl, kupfer-gebürstet
luminaire en suspension; acier, cuivre brossé

H 2000, Ø 100



E27



1x 60W



9 002759 325398

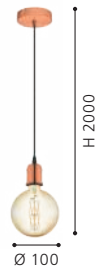

32531 YORTH

pendant light; steel, grey
Hängeleuchte; Stahl, grau
luminaire en suspension; acier, gris

H 2000, Ø 110



E27



1x 60W



9 002759 325312

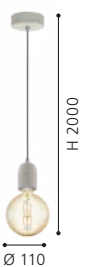

ILLUMINANTS





110098 p. 274	11099 p. 275	110101 p. 275	110095 p. 276	110096 p. 276	110097 p. 277	110109 p. 278	110111 p. 278
							
110112 p. 279	11898 p. 280	11899 p. 280	11901 p. 281	11902 p. 281	12591 p. 282	12592 p. 282	12593 p. 283
							
11836 p. 284	11837 p. 284	12594 p. 285	12596 p. 285	12586 p. 286	12584 p. 286	12585 p. 287	
							



BIG SIZE

- › extra large shape, modern colors and surfaces
- › straight and spiral filaments
- › the eye-catcher in your living area
- › energy-saving LED filament technology

- › extra große Form, moderne Farben und Oberflächen
- › gerade und spiralförmige Filamente
- › der Blickfang in Ihrem Wohnbereich
- › energiesparende LED Filamenttechnologie

- › Forme extra large, couleurs et surfaces modernes
- › filaments droits et spiralés
- › Attire l'attention dans votre salon
- › Technologie de filament LED à économie d'énergie

110098 E27-LED-APPLE

Dimensions Abmessungen / Dimensions	L 220, Ø 220
Socket Sockel / Douille	E27
Wattage Wattage / Puissance	4 W
Light Colour Lichtfarbe / Couleur lumineuse	2200 K
Operating voltage Betriebsspannung / Tension de fonctionnement	220-240V, 50/60Hz
Lifetime Lebensdauer / Durée de vie	15000 h
Colour rendering index Farbwiedergabeindex / L'indice de restitution de couleurs	80



4 W

50 lm
LUMEN



**not suitable for general lighting / nicht für die Allgemeinbeleuchtung geeignet /
n'est pas approprié pour l'éclairage général



110099 E27-LED-APPLE

Dimensions Abmessungen / Dimensions	L 220, Ø 220
Socket Sockel / Douille	E27
Wattage Wattage / Puissance	4 W
Light Colour Lichtfarbe / Couleur lumineuse	1900 K
Operating voltage Betriebsspannung / Tension de fonctionnement	220-240V, 50/60Hz
Lifetime Lebensdauer / Durée de vie	15000 h
Colour rendering index Farbwiedergabeindex / L'indice de restitution de couleurs	80



**not suitable for general lighting / nicht für die Allgemeinbeleuchtung geeignet / n'est pas approprié pour l'éclairage général

110101 E27-LED-APPLE

Dimensions Abmessungen / Dimensions	L 220, Ø 220
Socket Sockel / Douille	E27
Wattage Wattage / Puissance	4 W
Light Colour Lichtfarbe / Couleur lumineuse	1600 K
Operating voltage Betriebsspannung / Tension de fonctionnement	220-240V, 50/60Hz
Lifetime Lebensdauer / Durée de vie	15000 h
Colour rendering index Farbwiedergabeindex / L'indice de restitution de couleurs	80



**not suitable for general lighting / nicht für die Allgemeinbeleuchtung geeignet / n'est pas approprié pour l'éclairage général

110095 E27-LED-G200

Dimensions Abmessungen / Dimensions	L 255, Ø 200
Socket Sockel / Douille	E27
Wattage Wattage / Puissance	4 W
Light Colour Lichtfarbe / Couleur lumineuse	2200 K
Operating voltage Betriebsspannung / Tension de fonctionnement	220-240V, 50/60Hz
Lifetime Lebensdauer / Durée de vie	15000 h
Colour rendering index Farbwiedergabeindex / L'indice de restitution de couleurs	80



**BIG
SIZE**
L 255, Ø 200

4 W

50 lm
LUMEN



**not suitable for general lighting / nicht für die Allgemeinbeleuchtung geeignet /
n'est pas approprié pour l'éclairage général



110096 E27-LED-G200

Dimensions Abmessungen / Dimensions	L 255, Ø 200
Socket Sockel / Douille	E27
Wattage Wattage / Puissance	4 W
Light Colour Lichtfarbe / Couleur lumineuse	1900 K
Operating voltage Betriebsspannung / Tension de fonctionnement	220-240V, 50/60Hz
Lifetime Lebensdauer / Durée de vie	15000 h
Colour rendering index Farbwiedergabeindex / L'indice de restitution de couleurs	80



**BIG
SIZE**
L 255, Ø 200

4 W

40 lm
LUMEN



**not suitable for general lighting / nicht für die Allgemeinbeleuchtung geeignet /
n'est pas approprié pour l'éclairage général



110097 E27-LED-G200

Dimensions Abmessungen / Dimensions	L 255, Ø 200
Socket Sockel / Douille	E27
Wattage Wattage / Puissance	4 W
Light Colour Lichtfarbe / Couleur lumineuse	1600 K
Operating voltage Betriebsspannung / Tension de fonctionnement	220-240V, 50/60Hz
Lifetime Lebensdauer / Durée de vie	15000 h
Colour rendering index Farbwiedergabeindex / L'indice de restitution de couleurs	80



**BIG
SIZE**
L 255, Ø 200

4 W

40 lm
LUMEN



**not suitable for general lighting / nicht für die Allgemeinbeleuchtung geeignet /
n'est pas approprié pour l'éclairage général

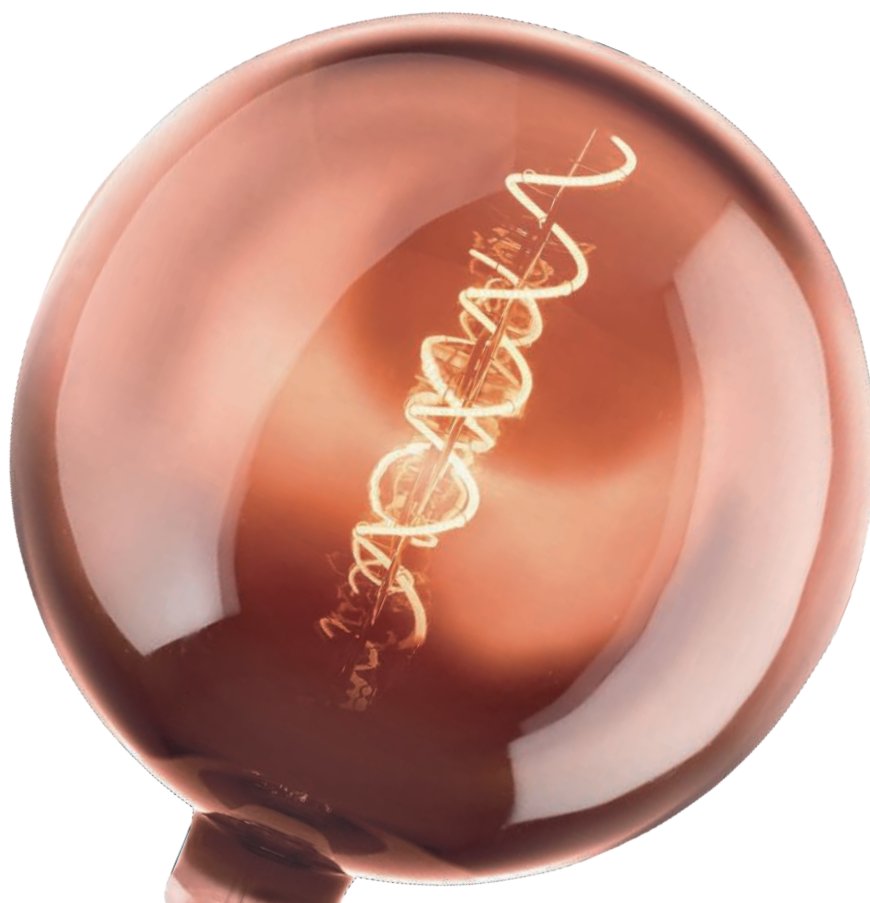

110109 E27-LED-E140

Dimensions Abmessungen / Dimensions	L 340, Ø 140
Socket Sockel / Douille	E27
Wattage Wattage / Puissance	8 W
Light Colour Lichtfarbe / Couleur lumineuse	2100 K
Operating voltage Betriebsspannung / Tension de fonctionnement	220-240V, 50/60Hz
Lifetime Lebensdauer / Durée de vie	15000 h
Colour rendering index Farbwiedergabeindex / L'indice de restitution de couleurs	80



**BIG
SIZE**
L 340, Ø 140

8 W

806 lm
LUMEN

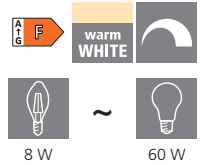

110111 E27-LED-PS160

Dimensions Abmessungen / Dimensions	L 320, Ø 160
Socket Sockel / Douille	E27
Wattage Wattage / Puissance	8 W
Light Colour Lichtfarbe / Couleur lumineuse	2100 K
Operating voltage Betriebsspannung / Tension de fonctionnement	220-240V, 50/60Hz
Lifetime Lebensdauer / Durée de vie	15000 h
Colour rendering index Farbwiedergabeindex / L'indice de restitution de couleurs	80



**BIG
SIZE**
L 320, Ø 160

8 W

806 lm
LUMEN

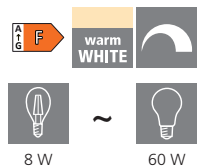

110112 E27-LED-G200

Dimensions Abmessungen / Dimensions	L 305, Ø 200
Socket Sockel / Douille	E27
Wattage Wattage / Puissance	8 W
Light Colour Lichtfarbe / Couleur lumineuse	2100 K
Operating voltage Betriebsspannung / Tension de fonctionnement	220-240V, 50/60Hz
Lifetime Lebensdauer / Durée de vie	15000 h
Colour rendering index Farbwiedergabeindex / L'indice de restitution de couleurs	80



**BIG
SIZE**
L 305, Ø 200

8 W

806 lm
LUMEN

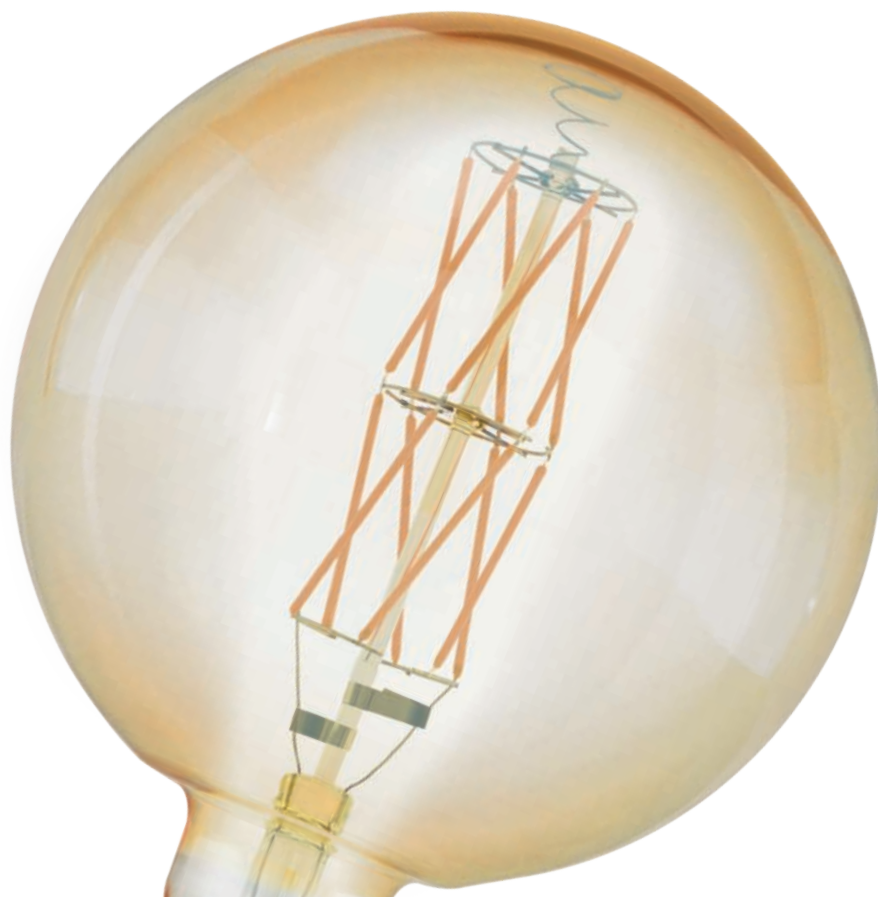

11898 E27-LED-E170

Dimensions Abmessungen / Dimensions	L 270, Ø 170
Socket Sockel / Douille	E27
Wattage Wattage / Puissance	4W
Light Colour Lichtfarbe / Couleur lumineuse	2700K
Operating voltage Betriebsspannung / Tension de fonctionnement	220-240V, 50/60Hz
Lifetime Lebensdauer / Durée de vie	25.000 h
Colour rendering index Farbwiedergabeindex / L'indice de restitution de couleurs	>80



**BIG
SIZE**
L 270, Ø 170

4W

470 lm
LUMEN

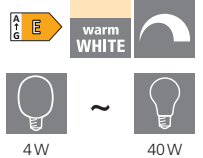

4W

40W



9 002759 118983

11899 E27-LED-TS140

Dimensions Abmessungen / Dimensions	L 200, Ø 140
Socket Sockel / Douille	E27
Wattage Wattage / Puissance	4W
Light Colour Lichtfarbe / Couleur lumineuse	2700K
Operating voltage Betriebsspannung / Tension de fonctionnement	220-240V, 50/60Hz
Lifetime Lebensdauer / Durée de vie	25.000 h
Colour rendering index Farbwiedergabeindex / L'indice de restitution de couleurs	>80



**BIG
SIZE**
L 200, Ø 140

4W

470 lm
LUMEN

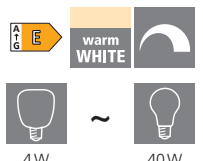

4W

40W



9 002759 118990

11901 E27-LED-G200

Dimensions Abmessungen / Dimensions	L 255, Ø 200
Socket Sockel / Douille	E27
Wattage Wattage / Puissance	4W
Light Colour Lichtfarbe / Couleur lumineuse	2700K
Operating voltage Betriebsspannung / Tension de fonctionnement	220-240V, 50/60Hz
Lifetime Lebensdauer / Durée de vie	25.000 h
Colour rendering index Farbwiedergabeindex / L'indice de restitution de couleurs	>80



**BIG
SIZE**
L 255, Ø 200

4W

470 lm
LUMEN

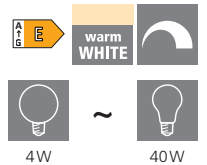

11902 E27-LED-R140

Dimensions Abmessungen / Dimensions	L 190, Ø 140
Socket Sockel / Douille	E27
Wattage Wattage / Puissance	4W
Light Colour Lichtfarbe / Couleur lumineuse	2700K
Operating voltage Betriebsspannung / Tension de fonctionnement	220-240V, 50/60Hz
Lifetime Lebensdauer / Durée de vie	25.000 h
Colour rendering index Farbwiedergabeindex / L'indice de restitution de couleurs	>80



**BIG
SIZE**
L 190, Ø 140

4W

470 lm
LUMEN

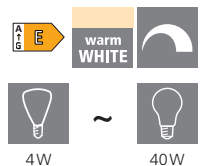

12591 E27-LED-E140

Dimensions Abmessungen / Dimensions	L 342, Ø 140
Socket Sockel / Douille	E27
Wattage Wattage / Puissance	4W
Light Colour Lichtfarbe / Couleur lumineuse	2200K
Operating voltage Betriebsspannung / Tension de fonctionnement	220-240V, 50/60Hz
Lifetime Lebensdauer / Durée de vie	15.000 h
Colour rendering index Farbwiedergabeindex / L'indice de restitution de couleurs	>80



**BIG
SIZE**
L 342, Ø 140

4W

400 lm
LUMEN

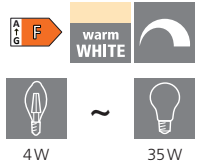

12592 E27-LED-PS160

Dimensions Abmessungen / Dimensions	L 318, Ø 160
Socket Sockel / Douille	E27
Wattage Wattage / Puissance	4W
Light Colour Lichtfarbe / Couleur lumineuse	2200K
Operating voltage Betriebsspannung / Tension de fonctionnement	220-240V, 50/60Hz
Lifetime Lebensdauer / Durée de vie	15.000 h
Colour rendering index Farbwiedergabeindex / L'indice de restitution de couleurs	>80



**BIG
SIZE**
L 318, Ø 160

4W

400 lm
LUMEN

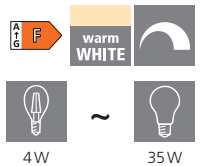

12593 E27-LED-G200

Dimensions Abmessungen / Dimensions	L 305, Ø 200
Socket Sockel / Douille	E27
Wattage Wattage / Puissance	4W
Light Colour Lichtfarbe / Couleur lumineuse	2200K
Operating voltage Betriebsspannung / Tension de fonctionnement	220-240V, 50/60Hz
Lifetime Lebensdauer / Durée de vie	15.000 h
Colour rendering index Farbwiedergabeindex / L'indice de restitution de couleurs	>80



**BIG
SIZE**
L 305, Ø 200

4W

400 lm
LUMEN

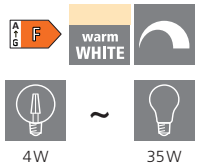

11836 E27-LED-B80

Dimensions Abmessungen / Dimensions	L 173, Ø 80
Socket Sockel / Douille	E27
Wattage Wattage / Puissance	4W
Light Colour Lichtfarbe / Couleur lumineuse	2200K
Operating voltage Betriebsspannung / Tension de fonctionnement	220-240V, 50/60Hz
Lifetime Lebensdauer / Durée de vie	25.000 h
Colour rendering index Farbwiedergabeindex / L'indice de restitution de couleurs	>80
Selling Unit Verpackungseinheit / Unité d'emballage	10

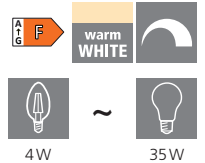

4W

380 lm
LUMEN
**11837 E27-LED-BR150**

Dimensions Abmessungen / Dimensions	L 160, Ø 150
Socket Sockel / Douille	E27
Wattage Wattage / Puissance	4W
Light Colour Lichtfarbe / Couleur lumineuse	2200K
Operating voltage Betriebsspannung / Tension de fonctionnement	220-240V, 50/60Hz
Lifetime Lebensdauer / Durée de vie	25.000 h
Colour rendering index Farbwiedergabeindex / L'indice de restitution de couleurs	>80

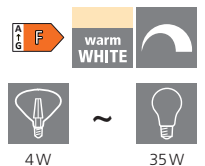

4W

380 lm
LUMEN

12594 E27-LED-T125

Dimensions Abmessungen / Dimensions	L 180, Ø 125
Socket Sockel / Douille	E27
Wattage Wattage / Puissance	4W
Light Colour Lichtfarbe / Couleur lumineuse	2200K
Operating voltage Betriebsspannung / Tension de fonctionnement	220-240V, 50/60Hz
Lifetime Lebensdauer / Durée de vie	15.000 h
Colour rendering index Farbwiedergabeindex / L'indice de restitution de couleurs	>80



4W

400 lm
LUMEN

A++ **warm WHITE**

4W ~ 35W

9 002759 125943

12596 E27-LED-R140

Dimensions Abmessungen / Dimensions	L 152, Ø 140
Socket Sockel / Douille	E27
Wattage Wattage / Puissance	4W
Light Colour Lichtfarbe / Couleur lumineuse	2200K
Operating voltage Betriebsspannung / Tension de fonctionnement	220-240V, 50/60Hz
Lifetime Lebensdauer / Durée de vie	15.000 h
Colour rendering index Farbwiedergabeindex / L'indice de restitution de couleurs	>80



4W

400 lm
LUMEN

A++ **warm WHITE**

4W ~ 35W

9 002759 125967

12586 E27-LED-G150

Dimensions Abmessungen / Dimensions	L 200, Ø 150
Socket Sockel / Douille	E27
Wattage Wattage / Puissance	2W
Light Colour Lichtfarbe / Couleur lumineuse	2200K
Operating voltage Betriebsspannung / Tension de fonctionnement	220-240V, 50/60Hz
Lifetime Lebensdauer / Durée de vie	15.000 h
Colour rendering index Farbwiedergabeindex / L'indice de restitution de couleurs	>80
Selling Unit Verpackungseinheit / Unité d'emballage	10



2W

200 lm
LUMEN**12584 E27-LED-G95**

Dimensions Abmessungen / Dimensions	L 139, Ø 93
Socket Sockel / Douille	E27
Wattage Wattage / Puissance	2W
Light Colour Lichtfarbe / Couleur lumineuse	2200K
Operating voltage Betriebsspannung / Tension de fonctionnement	220-240V, 50/60Hz
Lifetime Lebensdauer / Durée de vie	15.000 h
Colour rendering index Farbwiedergabeindex / L'indice de restitution de couleurs	>80
Selling Unit Verpackungseinheit / Unité d'emballage	10



2W

200 lm
LUMEN

12585 E27-LED

Dimensions Abmessungen / Dimensions	L 167, Ø 95
Socket Socket / Douille	E27
Wattage Wattage / Puissance	2W
Light Colour Lichtfarbe / Couleur lumineuse	2200K
Operating voltage Betriebsspannung / Tension de fonctionnement	220-240V, 50/60Hz
Lifetime Lebensdauer / Durée de vie	15.000 h
Colour rendering index Farbwiedergabeindex / L'indice de restitution de couleurs	>80
Selling Unit Verpackungseinheit / Unité d'emballage	10



2W

200 lm
LUMEN

A+ **F** **warm WHITE**

2W 20W

9 002759 125851



EGLO WORLDWIDE

EGLO WELTWEIT / EGLO DANS LE MONDE



 **AUSTRIA**
EGLO LEUCHTEN GMBH

Heiligkreuz 22
6136 Pill
T: +43 5242 6996 0 | F: +43 5242 6996 972
info-austria@eglo.com

 **CHILE**
EGLO CHILE ILUMINACIÓN LTDA.

Av. Américo Vespucio Norte 1930
Conchalí - Santiago de Chile
T: +562 2 595 2222
info-chile@eglo.com

 **DENMARK**
EGLO DANMARK A/S

Agerbakken 20
8362 Hørning
T: +45 70 22 55 11 | F: +45 70 22 55 221
info-denmark@eglo.com

 **AUSTRALIA**
EGLO LIGHTING AUSTRALIA

5/339 Archerfield Road
4077 Richlands | Queensland
T: +61 7 3375 1413 | F: +61 7 3375 1412
info@eglolighting.com.au

 **CHINA**
DONGGUAN EGLO LIGHTING COMMERCIAL
CO LTD

No.1 | Shangqiao Industrial Rd Shangqiao, Dongcheng
Dongguancity, Guanzhouprovince
T: +86 769 2203 3866 | F: +86 769 2203 6866
info-china@eglo.com

 **ESTONIA**
MOODNE VALGUSTUS AS

Rävalapst. 7
10143 Tallinn
T: +372 667 6670 | F: +372 631 3195
info-global@eglo.com

 **BELGIUM**
EGLO BELGIUM BV

Antwerpsesteenweg 247
2950 Kapellen
T: +32 3 250 60 80 | F: +32 3 219 80 67
info-belgium@eglo.com

 **COLOMBIA**
EGLO COLOMBIA ILUMINACIÓN SAS

Autopista Norte 800 Mts adelante del Peaje de los Andes
Costado Oriental Km 19 Lote 30
Bogotá - Chia
T: +57 (1) 744 2339
info-global@eglo.com

 **FINLAND**
EGLO FINLAND OY

Malmiraitti 17A
700 Helsinki
T: +358 20 7649 820 | F: +358 20 7649 821
info-finland@eglo.com

 **BOSNIA AND HERZEGOVINA**
EGLO RASVJETA BH D.O.O.

Ormanica bb
76250 Gradacac
T: +387 35 86 85 00 | F: +387 35 82 44 41
info-Bosnia-Herzegovina@eglo.com

 **COSTA RICA**
EGLO COSTA RICA

Centro Comercial Calle Real local #8
Guachipilín de Escazú de la sucursal del BAC
San Jose 800 metros al norte | San Jose
T: +506-2289-4690 | F: +506-2100-6384
info-costarica@eglo.com

 **FRANCE**
EGLO FRANCE LUMINAIRE SARL

Z.A. Jeune Bois | 2 Rue de la Martinique
68274 Wittenheim
T: +33 3 89 62 50 45 | F: +33 389 6250 49
info-france@eglo.com

 **BULGARIA**
EGLO BULGARIA EOOD

Main Road Burgas-Sofia | 5th kilometer | Building EGLO
8000 Burgas
T: +359 56 960 403 | F: +359 56 53 05 95
info-bulgaria@eglo.com

 **CROATIA**
EGLO RASVJETA D.O.O.

Jadranska avenija 9a
10000 Zagreb
T: +385 1 379 40 62 | F: +385 1 379 41 04
info-croatia@eglo.com

 **GERMANY**
EGLO LEUCHTEN HANDELS GMBH

Kleinbahnstr. 35
59759 Arnsberg
T: +49 2932 6269 0 | F: +49 2932 6269 39
info-germany@eglo.com

 **CANADA**
EGLO CANADA INC.

20700 Route Transcanadienne
H9X 4B7 Baie D'Ufré, Quebec
T: +1 514 457 5483 | F: +1 514 457 5487
info-canada@eglo.com

 **CZECH REPUBLIC**
EGLO CZ+SK s.r.o.

Náchodská 2479/63
193 00 Praha 9 Horní Pocernice
T: +420 281 924 163 | F: +420 281 925 205
info-czechrepublic@eglo.com

 **GREAT BRITAIN AND IRELAND**
EGLO UK LTD.

Unit 12 Cirrus Park, Lower Farm Road, Moulton Park
Industrial Estate, Northampton NN3 6UR
T: +44 1604 790 986 | F: +44 1604 670 282
info-greatbritain@eglo.com

**GREECE**

EGLO HELLAS A.E.

Sykias 2 and parodos dekeleias
13679 Acharnai
T: +30 21 0800 2363 | F: +30 210 240 07 29
info-greece@eglo.com

**HUNGARY - PRODUCTION AND LOGISTICS**

EGLO MAGYARORSZAG KFT.

Fő út. 155
3060 Paszto
T: +36 32 560 050 | F: +36 32 560 040
info-hungary@eglo.com

**INDIA**

EGLO INDIA PRIVATE LIMITED

A-307, Ansal Chambers - 1, 3, Bhikaji Cama Place,
110066 Delhi
T: +91 85279 44288
info-india@eglo.com

**ITALY**

EGLO ITALIANA S.R.L.

Via Giotto, 4
31021 Mogliano Veneto (TV)
T: +39 041 45 66 232 / -245/ -251 |
F: +39 041 45 74 066 / -071
info-italy@eglo.com

**KAZAKHSTAN**

EGLO KAZAKHSTAN LLP

Al-Farabi Avenue 7, Office 72, 14rd floor, Block 4A,
Nurly-Tau Business Center
50059 Almaty
T: +7 727 293 25 20 | M: +7 701 031 00 00
info-kazakhstan@eglo.com

**KOSOVO**

EGLO KOSOVA LLC

Lugisht e qytetit pn
20000 Prizren
T: +377 44 2166 87 | SHOP: +381 29 2442 84
info-kosovo@eglo.com

**LATVIA**

MOODNE VALGUSTUS AS

Rävalapst.7
10143 Tallinn
T: +370 652 49923 | T: +372 667 6670
info-latvia@eglo.com

**LITHUANIA**

MOODNE VALGUSTUS AS

Rävalapst.7
10143 Tallinn
T: +370 652 49923 | T: +372 667 6671
info-latvia@eglo.com

**MAGYARORSZÁG – ÉRTÉKESÍTÉS**

EGLO LUX KFT.

Fő út. 143/A
2120 Dunakeszi
T: +36 27 341 353 | F: +36 27 341 409
info-hungary@eglo.com

**MALAYSIA**

EGLO ASIA SDN BHD

No. 13, Jalan Pelukis U1/46B, Temasya 18, Glenmarie,
40150 Shah Alam, Selangor Darul Ehsan
T: +6011 1050 2336 | F: +603 5567 9415
info-malaysia@eglo.com

**MEXICO**

EGLO MÉXICO ILUMINACIÓN S DE RL DE CV

Prolongación Avenida López Mateos Sur N°3561,
Fraccionamiento Los Gavilanes
C.P. 45645 Tlajomulco de Zúñiga | Jalisco
T: +52 33 3687 20 95
info-mexico@eglo.com

**MIDDLE EAST**

EGLO LIGHTING MIDDLE EAST FZE

P.O. BOX 262073, LOB6, OFFICE G18
Jebel Ali, Dubai, UAE
T: +97 148810080 | F: +97 148810081
gulf@eglo.com

**MOROCCO - EGLO AFRICA**

EGLO MAGHREB LUMINAIRES SARL

219 Bd Med Zerktoouni. Suite: 67
20330 Casablanca
T: +212 522 98 80 25 / -05
info-global@eglo.com | info.africa@eglo.com

**THE NETHERLANDS**

EGLO VERLICHTING NEDERLAND B.V.

Innovatiepark 20
4906 AA Oosterhout (NBR)
T: +31 162 48 28 30
info.netherlands@eglo.com

**NORWAY**

MS Belysning AS

Heiaveien 4
1900 Fetstund
T: +47 63 888500 | F: +47 63 888501
info-norway@eglo.com

**PERU**

EGLO PERU S.A.C

Av Primavera 1419
Distrito de Santiago de Surco y Departamento de Lima
T: +51 902 763 635
info-peru@eglo.com

**POLAND**

EGLO POLSKA SP. Z O.O.

Ul. Dzwiekowa 2
02-857 Warszawa
T: +48 22 644 57 55 | F: +48 22 644 89 82
info-poland@eglo.com

**PORTUGAL**

EGLO PORTUGAL ILUMINAÇÃO, LDA

Rua Fonte Parada, 125
4595-434 Seroa-Paços de Ferreira
T: +351 255 890 000 | F: +351 255 892 346
info-portugal@eglo.com

**ROMANIA**

EGLO ROMANIA PRODEXIM SRL.

Str. Atomistilor nr. 1D
77125 Magurele - Ilfov
T: +40 314 250 902 | F: +40 314 250 899
info-romania@eglo.com

**RUSSIA**

EGLO LIGHTING LLC

Varshavskoe shosse 3 | Office 23
117105 Moscow
T: +7495 789 4311 | F: +7495 789 4312
info-russia@eglo.com

**SERBIA**

EGLO RASVETA DOO

Stefana Prvovenčanog 28
11000 Beograd
T: +381 11 3981 366 | F: +381 11 3981 389
info-serbia@eglo.com

**SLOVAKIA**

EGLO CZ+SK s.r.o

Náchodská 2479/63
193 00 Praha 9 Horní Počernice
T: +421 313 211 551 | F: +421 313 211 556
info-slovakia@eglo.com

**SLOVENIA**

EGLO RASVJETA D.O.O.

Jadranska avenija 9a
10000 Zagreb
T: +386 158 093 18
info-slovenia@eglo.com

**SPAIN**

EGLO ESPAÑA ILUMINACION S.L.

Avda. de Castilla 1 (Edf. Best Point) 2º-16A
28830 San Fernando de Henares, Madrid
T: +34 91 677 9044 | F: +34 91 677 0304
info-spain@eglo.com

**SWEDEN**

EGLO SVERIGE AB

Star Street 1
512 50 Svenljunga
T: +46 340 623 505 | F: +46 340 623 605
info-sweden@eglo.com

**SWITZERLAND**

EGLO SCHWEIZ AG

Seetalstraße 142
6032 Emmen
T: +41 41 268 69 59 | F: +41 41 268 69 58
info-switzerland@eglo.com

**TURKEY**

EGLO Aydınlatma ithalat ihracat Ltd. Şti.

Eyüp Sultan Mah. Sekmen Cad. No:18/2
34855 Sancaktepe / Istanbul Samandira
T: +90 216 311 09 -02 / -03 / -04 |
F: +90 216 311 09 / -05
info-turkey@eglo.com

**UKRAINE**

EGLO UKRAINE LTD

Vatslava Gavela boulevard, 6/7-A,
03124 Kyiv
T: +38 044 463 98 41 | F: +38 044 468 84 67
info-ukraina@eglo.com

**USA**

EGLO USA, INC.

3640 Royal South Parkway
30349 Atlanta, Georgia
T: +1 404 477 5601 | F: +1 404 393 7053
info-usa@eglo.com

HOW TO READ

ERKLÄRUNG / COMMENT LIRE

DIMENSIONS DIMENSIONEN DIMENSIONS

all dimensions in mm | alle Größen in mm | toutes dimensions en mm

L = length | Länge | longueur

B = width | Breite | largeur

H = height | Höhe | hauteur

Ø = diameter | Durchmesser | diamètre

A = projection length | Ausladung | amplitude

ET = installation depth | Einbautiefe | profondeur utile

Base = base dimensions | Sockelmaße | dimensions de base

Attention! The dimensions relate solely to the sizes of the luminaire. Any air spaces that would be relevant for a safe operating of the lamp were not considered.

Achtung! Die Größen beziehen sich nur auf die Abmessungen der Leuchte. Etwaige Lufträume, die für einen sicheren Betrieb der Leuchte notwendig sind, werden nicht berücksichtigt.

Attention! Les dimensions se réfèrent à la taille de la lampe seulement. Espacements éventuels, que seraient importants pour une opération de la lampe sans danger, n'ont pas été considérés.

PRODUCT / PRODUCT IN THE AMBIANCE PRODUKT / PRODUKTE IM AMBIENTE PRODUITS / PRODUITS DANS L'AMBIENCE

You can find the article number next to each product on the page and in the ambiance pictures.

Sie finden die Artikelnummer auf jeder Seite und neben jeder Abbildung des Produktes und auf unseren Ambientebildern.

Vous pouvez trouver le numéro d'article à la page et à côté de chaque produit dans les images de l'ambiance.

BUTTONS BUTTONS BOUTONS

LED Lightcolour | LED Lichtfarbe | couleur de LED



Bulb included | Leuchtmittel inkludiert | ampoules inclus



SKETCHES SKIZZEN CROQUIS

The sketches state the most meaningful dimensions. If a product is adjustable by will, a turquoise arrow marks this function and only the maximum dimensions are indicated.

Die Bemaßung der Skizzen umfasst jeweils die aussagekräftigsten Größen. Bei verstellbaren Produkten kennzeichnet ein türkiser Pfeil diese Funktion und nur die maximalen Größen werden angegeben.

Les dimensions des croquis comprennent les plus représentatives. Si un produit est réglable au choix, une flèche turquoise affiche cette fonction et rien que les dimensions maximales sont indiquées.



ARTICLE NUMBER
ARTIKELNUMMER
NUMÉRO D'ARTICLE

43314

43292 BRIDEKIRK

pendant light; steel, black / fabric, linen, natural
Hängeleuchte; Stahl, schwarz / Textil, Leinen, natur
luminaire en suspension; acier, noir / tissu, lin, nature

H 1100, Ø 400



E27 1x 40W



9 002759 432928



43314 COULSDON

pendant light; steel, black / film, black, white
Hängeleuchte; Stahl, schwarz / Folie, schwarz, weiss
luminaire en suspension; acier, noir / film, noir, blanc

H 1310, Ø 145



E27 5x 10W



9 002759 433147



**DESCRIPTION
BESCHREIBUNG
DESCRIPTION**

The product description is composed as follows:
luminaire type; enclosure material, enclosure colour / glass or shade material, glass or shade colour

Die Produktbeschreibung setzt sich wie folgt zusammen:
Leuchtenart; Gehäusematerial, Gehäusefarbe / Schirm- bzw. Glasmaterial, Schirm- bzw. Glasfarbe

La description du produit est composée comme suit:
type de luminaire; matériel de boîtier, couleur de boîtier / matériel de verre ou abat-jour, couleur de verre ou abat-jour



32469



43344



DETAIL 43314

The luminaire heads can be installed in 2 ways on the ceiling.
Die Leuchtenköpfe können auf 2 Arten an die Decke montiert werden.
Les têtes de luminaire peuvent être montées de 2 manières au plafond.

**SERIES NAME
SERIENNAME
NOM DE LA SÉRIE**

32469 STAVERTON

ceiling light; steel, black
Deckenleuchte; Stahl, schwarz
plafonnier; acier, noir

H 250, Ø 365



E27 1x 60W



9 002759 324698

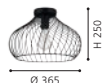

43344 STAVERTON

pendant light; steel, black
Hängeleuchte; Stahl, schwarz
luminaire en suspension; acier, noir

H 1100, Ø 365



E27 1x 60W



9 002759 433444



**ENERGY EFFICIENCY LABELS
ENERGIEEFFIZIENZ-LABEL
LABEL DE L'EFFICACITÉ ÉNERGÉTIQUE**

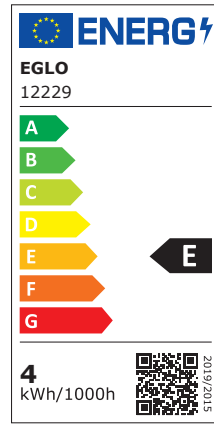

The new energy label must be indicated on all light sources with a luminous flux between 60 and 82,000 lumens and OLED. This applies to lamps, LED modules and luminaires where the light source cannot be removed without destroying it.

Das neue Energielabel muss auf allen Lichtquellen mit einem Lichtstrom zwischen 60 und 82.000 Lumen und OLED angegeben werden. Dies gilt für Lampen, LED-Module und Leuchten, bei denen die Lichtquelle nicht zerstörungsfrei entnommen werden kann.

Le nouveau label énergétique doit être indiqué sur toutes les sources lumineuses dont le flux lumineux est compris entre 60 et 82 000 lumens et sur les OLED. Cela s'applique aux lampes, aux modules LED et aux luminaires dont la source lumineuse ne peut être retirée sans être détruite.

The information on the label includes: / Die Angaben auf dem Etikett beinhalten: / Les informations figurant sur l'étiquette sont les suivantes :

- › Name/Trademark
Name/Warenzeichen
Nom/marque de commerce
- › Model / Modell / Modèle
- › Energy label scale A-G / Energielabel-Skala A-G / Échelle d'étiquetage énergétique A-G
- › Energy consumption for 1,000 hours of use/
Energieverbrauch bei 1.000 Stunden Nutzung/
Consommation d'énergie pour 1 000 heures d'utilisation
- › Energy efficiency class of the product/
Energieeffizienzklasse des Produkts/
Classe d'efficacité énergétique du produit
- › QR Code to EPREL (Product Database of the European Product Registry for Energylabelling)/
QR Code zur EPREL (Produktdatenbank der European Product Registry for Energylabelling)/
Code QR pour EPREL (base de données des produits du registre européen des produits pour l'étiquetage énergétique)
- › The energy spectrum ranges from G to A.
Das Energiespektrum reicht von G bis A.
Le spectre énergétique va de G à A.

**PICTOGRAMMES
PIKTOGRAMME
PICTOGRAMMES**

Technical details are represented as pictograms. An overview over all pictograms can be found on the next pages.

Technische Details werden als Piktogramme dargestellt. Eine Übersicht über alle Piktogramme finden Sie auf den nächsten Seiten.

Les détails techniques sont représentés sous forme de pictogrammes. Vous trouverez un aperçu de tous les pictogrammes dans les pages suivantes.

Look out for this Logo!

Achten Sie auf das Logo!

Soyez attentif au logo !

What is a forest?

A peaceful oasis, the green lungs of the world, and an adventure playground for children of all ages!

The Forest Stewardship Council® (FSC®) is a global, not-for-profit organisation dedicated to the promotion of responsible forest management worldwide. The FSC® defines standards for responsible forest management in accordance with established principles that are developed and supported by stakeholders from the environmental, social and economic spheres. For more information, please see www.fsc.org.

Was ist Wald für uns?

Eine Oase der Ruhe, die Lunge der Welt oder ein Abenteuerspielplatz für große und kleine Kinder!

Das Forest Stewardship Council® (FSC®) ist eine globale, gemeinnützige Organisation, mit dem Zweck verantwortungsvolle Waldbewirtschaftung weltweit zu fördern. FSC® definiert Standards für eine verantwortungsvolle Waldbewirtschaftung nach festgelegten Prinzipien, die von Interessenvertretern aus den Bereichen Umwelt, Soziales und Wirtschaft entwickelt und getragen werden. Für weitere Informationen besuchen Sie www.fsc.org.

Que représente la forêt pour nous ?

Une oasis de calme, les poumons du monde ou un terrain de jeu d'aventure pour les enfants de tous âges !

Le Forest Stewardship Council® (FSC®) est une organisation internationale à but non lucratif dont le but est de promouvoir une gestion forestière responsable dans le monde entier. Le FSC® définit des normes de gestion forestière responsable selon des principes établis qui sont développés et soutenus par les parties prenantes des secteurs environnemental, social et économique. Pour plus d'informations, veuillez consulter www.fsc.org.

Look out for FSC® -certified products!
Achten Sie auf FSC® -zertifizierte Produkte!
Soyez attentif aux produits certifiés FSC® !



The mark of
responsible forestry

DIGITAL CATALOGUE

This year, we are also making the Trend & Style catalogue in front of you available online, including lots of extra information and additional features. In addition to search and filter functions, the online catalogue includes extensive product photos, videos and additional information, complementing the paper edition wonderfully. Take a look at

<https://catalogue.eglo.com>

In diesem Jahr präsentieren wir den vor Ihnen liegenden Trend & Style Katalog wieder als Online-Katalog mit vielen Zusatzinformationen und zusätzlichen Features. Neben Such- und Filterfunktionen bietet der Online-Katalog mit reichhaltigen Produktabbildungen, Videos und zusätzlichen Informationen einen erheblichen Mehrwert zur gebundenen Ausgabe. Klicken Sie sich rein unter <https://catalogue.eglo.com>

Cette année, nous présentons le catalogue Trend & Style devant vous pour la première fois en tant que catalogue en ligne avec de nombreuses informations complémentaires et des informations complémentaires Caractéristiques. Cette version contient de nombreuses informations et fonctionnalités complémentaires. Outre les fonctionnalités de recherche et de filtrage, le catalogue en ligne propose de nombreuses illustrations de produits, des vidéos et des informations complémentaires : une valeur ajoutée considérable par rapport à la version papier. Cliquez ici pour le découvrir : <https://catalogue.eglo.com>

NEW/NEU/NOUVEAU





















43413











































LEGEND

PICTOGRAM PIKTOGRAMME PICTOGRAMME

SOCKETS FASSUNGEN DOUILLES

 LED	 G4	 G53
 2G7	 G5	 GU5,3 / MR16
 2G11	 G9	 GU10
 2GX13	 G10Q	 GX53
 E14	 G13	 GY6,35
 E27	 G23	 R7s

BULBS LEUCHTMITTEL AMPOULES











 E14 / C35	 E27 / A60 Halogen	 E27 / E140 Filament
 E14 / C35f	 E27 / R63 Halogen	 E27 / PS160 Filament
 E14 / D45	 E27 / A60 LED	 E27 / T30 Filament
 E14 / C35f LED	 E27 / A60 Filament	 E27 / T32 Filament
 E14 / D45 Halogen	 E27 / A65 LED	 G4 / T9
 E14 / C35 Halogen	 E27 / A75 Filament	 G4 / LT9
 E14 / T22	 E27 / G45 LED	 G4 / LT14
 E14 / C35 Filament	 E27 / G45 Filament	 G9
 E14 / C37 Filament	 E27 / G80 Filament	 G9 LED
 E14 / C35f Filament	 E27 / G95	 GU10
 E14 / C37f Filament	 E27 / G95 Filament	 GU10 LED
 E14 / P45 LED	 E27 / G125	 GU10 SMD LED
 E14 / P45 Filament	 E27 / G95 LED	 GX53 / LF75
 E14 / P50	 E27 / G200 Filament	LED LED board / LED Platine / LED bord
 E14 / ST48 Filament	 E27 / R63 LED	 MR16
 E14 / ST64 Filament	 E27 / ST48 Filament	 MR16 LED
 E14 / T20 LED	 E27 / ST64 Filament	 R7s / 78mm
 E27 / A60	 E27 / B80 Filament	 R7s / 118mm
 E27 / G90	 E27 / BR150 Filament	 R7s / 78mm LED
 E27 / QR63	 E27 / DP165 Filament	 R7s / 118mm LED

LIGHT COLOUR & LUMEN
LICHTFARBE & LUMEN
COULEUR LUMINEUX & LUMEN

















The colours of the LED are represented as pictogrammes (see below), their luminous flux directly beneath. The luminous flux is quoted in lumen and describes the amount of light generated by the LED. The higher the value, the brighter is the lamp. Lumens are LED boards and are the light measurement value in bulbs.

Die Farben der LED werden als Piktogramm (siehe unten) dargestellt, deren Lichtstrom direkt darunter. Der Lichtstrom wird in Lumen gemessen und gibt die erzeugte Lichtmenge der LED an. Je höher der Wert, desto heller das Produkt. Lichtstromangaben (Lumen) sind Platinen- bzw. Leuchtmittelwerte.

Les couleurs de LED ont représentés sous forme de pictogrammes, leur flux lumineux directement en dessous. L'unité de flux lumineux est le lumen et il mesure la quantité de lumière générée par les LED. Plus la valeur est élevée, plus la lampe est lumineuse. Les lumens sont l'unité de mesure de l'intensité lumineuse des ampoules et des panneaux led intégrés.

 RGB RGB RGB	 RGB + tunabel white RGB + tunabel white RGB + tunabel white
 RGB + white RGB + weiß RGB + blanc	 tunable white tunable white tunable white
 RGB + warmwhite RGB + warmweiß RGB + blanc chaud	 warm white warmweiß blanc chaud
 RGB + coldwhite RGB + kaltweiß RGB + blanc froid	 cold white kaltweiß blanc froid
 RGB + neutralwhite RGB + neutralweiß RGB + blanc neutral	 neutral white neutralweiß blanc neutre

SWITCHES & SENSORES
SCHALTER & SENSOREN
INTERRUPTEUR & CAPTEURS

 incl. cable & plug inkl. Kabel & Stecker câble & connecteur inclus	 pedal switch Trittschalter interrupteur à pied	 swedish plug Stecker Schweden connecteur swede
 internal dimmer eingebauter Dimmer variateur intégré	 cable switch Kabelschalter interrupteur à câble	 "Touch me" ON/OFF "Touch me" EIN/AUS "Touch me" ON/OFF
 button switch Druckknopf interrupteur de pression	 incl. cable & plug transformer inkl. Kabel & Stecktransformator câble & transformateur à prise	 "Touch me" ON/OFF & dimm "Touch me" EIN/AUS & Dimmen "Touch me" ON/OFF & graduable
 function switch Funktionsschalter interrupteur fonction	 remote control Fernbedienung télécommande	 pull switch Zugschalter interrupteur à bascule
 rocker switch Wippschalter interrupteur à bascule	 Day & Night Sensor Tag & Nacht Sensor sensor jour & nuit	 Timer - automatic on/off Zeitschaltuhr - automatisches Ein- & Ausschalten minuterie - peut être éteint et allumé automatiquement
 pedal dimmer Trittdimmer variateur à pied	 sensor Sensor sensor	

FUNKTIONS & COMFORT
FUNKTIONEN & KOMFORT
FONCTIONS & CONFORT



 incl. battery inkl. Akku incl. pile	 cutout (in mm) Ausschnitt (in mm) perçage du panneau (en mm)	 shortable kürzbar réductible
 incl. battery inkl. Batterie incl. pile	 dimmable dimmbar graduable	 Voltage Volt Voltage
 battery specifications Batteriespezifikationen spécifications des piles	 not dimmable nicht dimmbar ne pas graduable	 WATT Watt
 beam angle Ausstrahlwinkel angle de rayonnement	 replaceable LED austauschbare LED LED remplaçables	 Flicker-Free Flacker-Frei Sans Vacillements
 corner mount possible Eckmontage möglich montage en coin possible	 loadable in kg belastbar in kg chargeable en kg	 not suitable for general lighting nicht für die Allgemeinbeleuchtung geeignet n'est pas approprié pour l'éclairage général
 CRI Colour Rendering Index	 packaging / delivery unit Verpackungs- / Liefereinheit unité d'emballage / de livraison	

PROTECTION CLASS
SCHUTZKLASSE
CLASSE DE PROTECTION

The protection class indicates to what extent the lamp is protected against electric shock. All lamps in this catalogue are at least protected with the protection class 1 - a higher class is specified in the information box of the respective lamp.

Die Schutzklasse gibt an, inwiefern ein Produkt gegen einen elektrischen Schlag gesichert ist. Alle Leuchten in diesem Katalog sind mit mindestens Schutzklasse 1 gesichert, bei höheren Klassen wird das Symbol im Infokasten der Leuchte angegeben.

La classe de protection indique, dans quelle mesure la lampe est protégé contre les chocs électriques. Tous les lampes dans ce catalogue sont protégées au moins avec la classe 1 - une classe plus élevée est indiquée dans l'information de la lampe.

 protection class 1: protective earthing Schutzklasse 1: Schutzerdung classe de protection 1: prise de terre	 protection class 2: protective insulation Schutzklasse 2: Schutzisolation classe de protection 2: double isolation ou renforcée	 protection class 3: protective low voltage Schutzklasse 3: Schutzkleinspannung classe de protection 3: très basse tension de sécurité
---	---	---

PROTECTION RATING
SCHUTZGRAD
INDICE DE PROTECTION

The protection rating ensures the operational safety of luminaires. The first number specifies the extent of the protection against the ingress of foreign bodies, the second number identifies the humidity protection grade. All luminaires in this catalogue are at least protected with the rating IP20 - a higher rating is specified in the information box of the luminaire.

Der Schutzgrad gewährleistet die Betriebssicherheit von Leuchten. Die erste Ziffer des IP Grades beschreibt den Schutzzumfang gegen das Eindringen von Fremdkörpern, die zweite Ziffer informiert über den Grad des Feuchtigkeitsschutzes. Alle Leuchten in diesem Katalog sind mit mindestens Schutzgrad IP20 gesichert, bei höheren Graden wird das Symbol im Infokasten der Leuchte angegeben.

L'indice de protection assure la sécurité opérationnelle des luminaires. Le premier chiffre indique à quel point la protection est efficace contre l'insertion de corps étrangers, le second chiffre indique quant à lui le degré de protection par rapport à l'humidité. Tous les luminaires dans ce catalogue sont protégés au moins avec l'indice IP20 - un indice plus élevé est indiqué dans l'information d'article.

 IP33	 IP44	 IP54	 IP65	 IP67
--	--	--	---	--

REGISTER

SERIES NAMES

SERIENNAMEN

NOME DE PRODUITS

NAME NAME NOM	PAGE SEITE PAGE	NAME NAME NOM	PAGE SEITE PAGE	NAME NAME NOM	PAGE SEITE PAGE	NAME NAME NOM	PAGE SEITE PAGE
ADWICKLE	219	CARLTON 6	118	FINDLAY	205	LM_LED_E27	274-287
ALDERNEY	218	CARLTON 7	116-17	FORESTBURG	25	LONCINO	58
AMSFIELD	237	CARLTON-P	122-123	FRIJOLAS	192	LUBENHAM	38-39
ANWICK	220-221	CASTANUELO	142-143	GATEBECK	68-69	LUBENHAM 1	38
ANWICK 1	222	CATTERICK	18-19	GIACONECCHIA	188-189	LYNTON	192
ARNHEM	244, 246	CHARTERHOUSE	59	GILTSPUR	198	MADRESELVA	80
AUCKLAND	44	CHASELY	78	GLASTONBURY	164	MANBY	14-15
AUSNBY	229	CHERTSEY	212	GLYNEATH	228	MARDYKE	56-57
AUSTELL	158-59	CHESTER	167	GRANTHAM 1	43	MATLOCK	184-185, 186-187
AYCLIFFE	238	CHESTER 1	167	HALKIN	90	MEDIOUNA	246
AYESGARTH	236	CHESTER-P	168	HAMBLETON	252	MELILLA	260
AYLES	34-37	CHIEVELEY	88-89	HAPTON	173	MEOPHAM	212
BARNSTAPLE 1	32	CHISLE	199	HARBOROUGH	72	MILLIGAN	6-7,8-9
BARNSTAPLE 1	33-32	CLAVERDON	234-235	HAXEY	239	MONMOUNT	92
BASILDON	100	CLEVEDON	154	HETTONLE	238	MUMBLES	139
BASILDON	100 -101	CONSETT	90-91	HILCOTT	26-27	NAFFERTON	94-95
BASILDON 1	98	COPLEY	170-171	HODSOLL	211	NEWTOWN	156-157
BAZELY	181	CORETTO 2	172	HOGSMILL	214	NIMLET	251
BIDFORD	164-165	COTTINGHAM	208	HORNINGTOPS	209	OLDBURY	62
BORDESLEY	226-227	COULSDON	256	HORNWOOD	82-83	PADSTOW	208-209
BOYLE	80-31	COVALEDA	53	HORNWOOD 1	162-163	PALMORLA	112
BRADFORD	248-249	COVALEDA 1	50	HORNWOOD 2	79	PLIMSOLL	161
BRADFORD 1	249	CRANLEY	268	HYKEHAM	224-225	POMPEYA	178-179
BRAMERTON	86-87	DELLOW	12-13	IKESTON	20-21	PORT SETON	63
BRICKFIELD	24	DEMBLEBY	232-233	IPSDEN	98	PRESTWICK	192
BRIDEKIRK	256	DEMBLEBY 1	230	JADIDA	263	PRESTWICK 1	67
BRIDPORT	215	DISTAFF	113	JUBILY	10-11	PRESTWICK 2	66-67
CALARI	270	DUNDEE	168	KENSAL	250	PRESTWICK 3	190-191
CALLOW	102	EBURY	41	KILNSDALE	74	PRIDDY	45-46,48
CAPOSILE	252	EDALE	242	KINROSS	252	RAMPSTEAD	205-206,207
CARDIGAN	264	ELSWICK	60	KIRKCOLM	238	RAMPSTEAD 1	204
CARLTON	125-127	EMBLETON	54	LACEY	84-85	REDCLIFFE	16-17
CARLTON 1	114-115, 120-121,122	EVESHAM	72-73	LANTADA	165	ROCCAMENA	152-153
CARLTON 2	134-135	EXMOOR	61	LATCHELY	215	ROCKINGHAM	42
CARLTON 4	118	FAMBOROUGH	92-93	LAYHAM	70-71	RODING	210
CARLTON 5	119-120	FEMBARD	60	LITTLETON	96-97	RUSCOMB	200

NAME NAME NOM	PAGE SEITE PAGE	NAME NAME NOM	PAGE SEITE PAGE
SAFI	258	WILMCOTE	61
SALLICANO	181	WINKWORTH 1	40
SEDBERGH	23	WOOTTON	202-203
SHERBURN	103	WRINGTON	174-175
SHIREBROOK	33	WRINGTON 1	176-177
SOUTHERY	140-141	YORTH	269, 271
SPEKE	22	YOUNGSTOWN	204
STAVERTON	257		
STEELEVILLE	263		
STILLINGTON	136-137		
STOCKBURY	213		
STRAITON	130- 131,172-173		
STYPE	128-129		
SUDBURY	265		
SURFLEET	239		
TAKELEY	30		
TALBOT	265		
TALBOT 2	260		
TAMALLAT	261		
TARBES	134,144,145, 147-150,151		
TARBES 2	146		
TARLE	208		
TOWNSHEND	104-109		
TOWNSHEND 2	253		
TOWNSHEND 4	63-64,65		
TOWNSHEND 5	109-110,111		
TREBURLEY	50		
TRURO	44		
TRURO 1	42		
TRURO 2	42, 44		
TURROCK	28,29		
TWICKEN	182-183		
VERNHAM	133		
VINOZA	196		



REGISTER

ARTICLE NUMBER
ARTIKELNUMMER
NUMÉROS D'ARTICLE

NUMBER NUMMER NUMÉRO	PAGE SEITE PAGE	NUMBER NUMMER NUMÉRO	PAGE SEITE PAGE	NUMBER NUMMER NUMÉRO	PAGE SEITE PAGE	NUMBER NUMMER NUMÉRO	PAGE SEITE PAGE	NUMBER NUMMER NUMÉRO	PAGE SEITE PAGE	NUMBER NUMMER NUMÉRO	PAGE SEITE PAGE
11836	284	39835	189	43168	38	43318	204	43402	244	43483	133
11837	284	39854	26	43184	50	43319	204	43403	244	43493	200
11898	280	39855	26	43192	207	43322	214	43404	212	43494	200
11899	280	39856	27	43194	205	43324	222	43405	212	43495	200
11901	281	39857	27	43195	206	43325	222	43413	92	43499	199
11902	281	39868	27	43197	206	43326	222	43414	93	43522	63
12584	286	43001	121	43199	207	43328	208	43415	93	43523	64
12585	287	43002	120	43216	226	43331	174	43416	93	43524	64
12586	286	43004	134	43217	227	43333	174	43424	82	43525	65
12591	282	43045	82	43218	226	43334	175	43425	162	43526	65
12592	282	43046	82	43219	227	43344	257	43426	162	43527	199
12593	283	43047	83	43231	226	43351	204	43427	163	43528	199
12594	285	43048	83	43251	235	43352	209	43428	163	43531	13
12596	285	43057	118	43252	234	43353	50	43429	163	43532	13
31073	270	43058	118	43253	234	43358	131	43431	32	43533	13
31075	270	43077	119	43254	234	43359	130	43432	32	43534	16
32468	175	43078	120	43256	206	43361	130	43433	32	43535	16
32469	257	43096	175	43261	233	43363	209	43434	33	43536	17
32522	269	43113	238	43262	232	43364	208	43435	40	43537	17
32531	269	43126	61	43263	232	43365	60	43436	40	43538	17
32539	269	43129	78	43264	233	43366	130	43443	142	43541	88
32915	106	43131	110	43265	230	43374	176	43444	28	43542	88
32916	106	43132	110	43266	230	43375	177	43445	28	43543	89
32917	107	43133	111	43285	229	43376	176	43446	28	43544	89
32918	107	43134	109	43292	256	43377	176	43447	29	43545	80
32919	107	43135	110	43299	42	43378	112	43459	78	43546	80
33162	105	43136	111	43303	178	43379	112	43461	100	43548	67
33163	105	43137	111	43304	179	43389	215	43462	100	43549	67
33164	104	43141	164	43305	179	43393	246	43463	101	43551	98
33165	104	43152	63	43307	179	43394	24	43464	101	43552	98
33166	104	43159	72	43308	25	43395	24	43466	70	43553	198
33167	105	43162	38	43309	25	43396	211	43468	70	43554	198
39831	188	43163	39	43311	220	43397	211	43469	70	43555	246
39832	188	43164	38	43312	221	43398	221	43471	71	43556	246
39833	189	43165	39	43313	220	43399	118	43481	133	43558	83
39834	189	43166	39	43314	256	43401	244	43482	133	43559	181

NUMBER NUMMER NUMÉRO	PAGE SEITE PAGE	NUMBER NUMMER NUMÉRO	PAGE SEITE PAGE	NUMBER NUMMER NUMÉRO	PAGE SEITE PAGE	NUMBER NUMMER NUMÉRO	PAGE SEITE PAGE	NUMBER NUMMER NUMÉRO	PAGE SEITE PAGE	NUMBER NUMMER NUMÉRO	PAGE SEITE PAGE
43561	30	43628	6	43684	147	43755	102	43812	139	43852	225
43562	30	43629	108	43685	147	43756	102	43813	139	43853	224
43569	98	43631	170	43692	128	43758	268	43814	125	43854	224
43576	261	43632	171	43693	129	43766	136	43815	125	43855	225
43577	261	43633	170	43695	128	43767	136	43816	140	43866	236
43581	113	43634	170	43696	129	43768	137	43817	140	43867	236
43582	113	43635	80	43715	117	43769	136	43818	140	43868	238
43587	263	43636	81	43716	116	43771	18	43819	141	43869	239
43591	202	43641	92	43717	117	43772	18	43821	23	43871	238
43592	202	43642	250	43718	117	43773	18	43822	23	43872	228
43593	202	43643	56	43721	22	43774	19	43823	196	43873	228
43594	203	43644	57	43722	22	43775	219	43824	196	43874	239
43595	190	43645	56	43723	237	43776	219	43825	184	49024	123
43596	191	43646	56	43724	90	43777	219	43826	185	49026	122
43597	191	43647	8	43725	91	43781	242	43827	186	49037	61
43598	190	43648	8	43726	33	43782	242	43828	186	49039	168
43599	143	43649	9	43728	20	43783	242	43829	186	49076	68
43603	12	43651	9	43729	21	43784	218	43831	229	49077	68
43604	12	43652	251	43731	20	43785	218	43832	74	49078	68
43605	12	43653	251	43732	21	43786	218	43833	74	49079	69
43606	79	43654	146	43733	66	43794	15	43834	74	49081	134
43611	84	43655	146	43734	67	43795	14	43835	183	49111	192
43612	84	43661	11	43735	85	43796	14	43836	183	49141	154
43613	85	43662	10	43736	101	43797	15	43837	183	49142	154
43614	85	43663	10	43738	103	43798	90	43838	182	49143	154
43615	192	43664	10	43739	103	43799	90	43839	182	49148	165
43617	210	43665	11	43743	95	43801	269	43841	182	49156	164
43618	210	43666	11	43744	94	43802	269	43842	185	49201	264
43619	210	43668	181	43745	95	43803	269	43843	187	49202	264
43621	41	43669	181	43746	95	43804	73	43844	185	49213	248
43622	41	43671	79	43748	87	43805	72	43845	208	49214	248
43623	249	43678	147	43749	87	43806	73	43846	116	49221	265
43624	249	43679	144	43751	86	43807	73	43847	161	49235	44
43625	6	43681	144	43752	86	43808	143	43848	161	49238	42
43626	6	43682	145	43753	86	43809	143	43849	161	49243	44
43627	7	43683	145	43754	87	43811	139	43851	224	49247	42

NUMBER NUMMER NUMÉRO	PAGE SEITE PAGE	NUMBER NUMMER NUMÉRO	PAGE SEITE PAGE	NUMBER NUMMER NUMÉRO	PAGE SEITE PAGE	NUMBER NUMMER NUMÉRO	PAGE SEITE PAGE
49248	44	49488	134	49772	237	110109	278
49254	114	49489	252	49809	63	110111	278
49255	122	49492	45	49812	192	110112	279
49257	126	49495	58	49814	258		
49258	126	49496	58	49815	258		
49259	126	49509	159	49819	43		
49274	264	49519	167	49851	252		
49276	265	49549	97	49859	65		
49283	249	49564	60	49871	258		
49284	248	49617	53	49877	53		
49337	168	49618	53	49878	114		
49342	168	49619	36	49927	253		
49385	167	49643	152	49931	122		
49386	167	49644	152	49932	120		
49392	59	49645	153	49933	127		
49393	59	49646	153	49935	127		
49394	59	49647	36	49991	115		
49446	159	49648	35	49992	115		
49447	158	49649	34	49994	115		
49448	158	49652	34	49997	114		
49449	173	49653	34	94187	148		
49452	215	49684	62	94188	148		
49456	213	49685	62	94189	149		
49457	213	49694	205	94191	148		
49458	213	49698	97	94192	149		
49464	46	49714	260	94193	151		
49465	46	49717	260	94194	150		
49466	46	49718	37	94195	150		
49468	48	49722	36	94196	151		
49469	48	49724	252	94197	151		
49471	48	49736	173	94324	165		
49472	156	49738	172	94326	165		
49473	96	49744	109	94742	172		
49474	157	49755	108	95499	106		
49475	96	49761	54	110095	276		
49477	156	49762	54	110096	276		
49478	156	49764	263	110097	277		
49479	157	49765	263	110098	274		
49481	157	49768	260	110099	275		
49487	135	49771	237	110101	275		



NOTES

NOTIZEN

NOTES

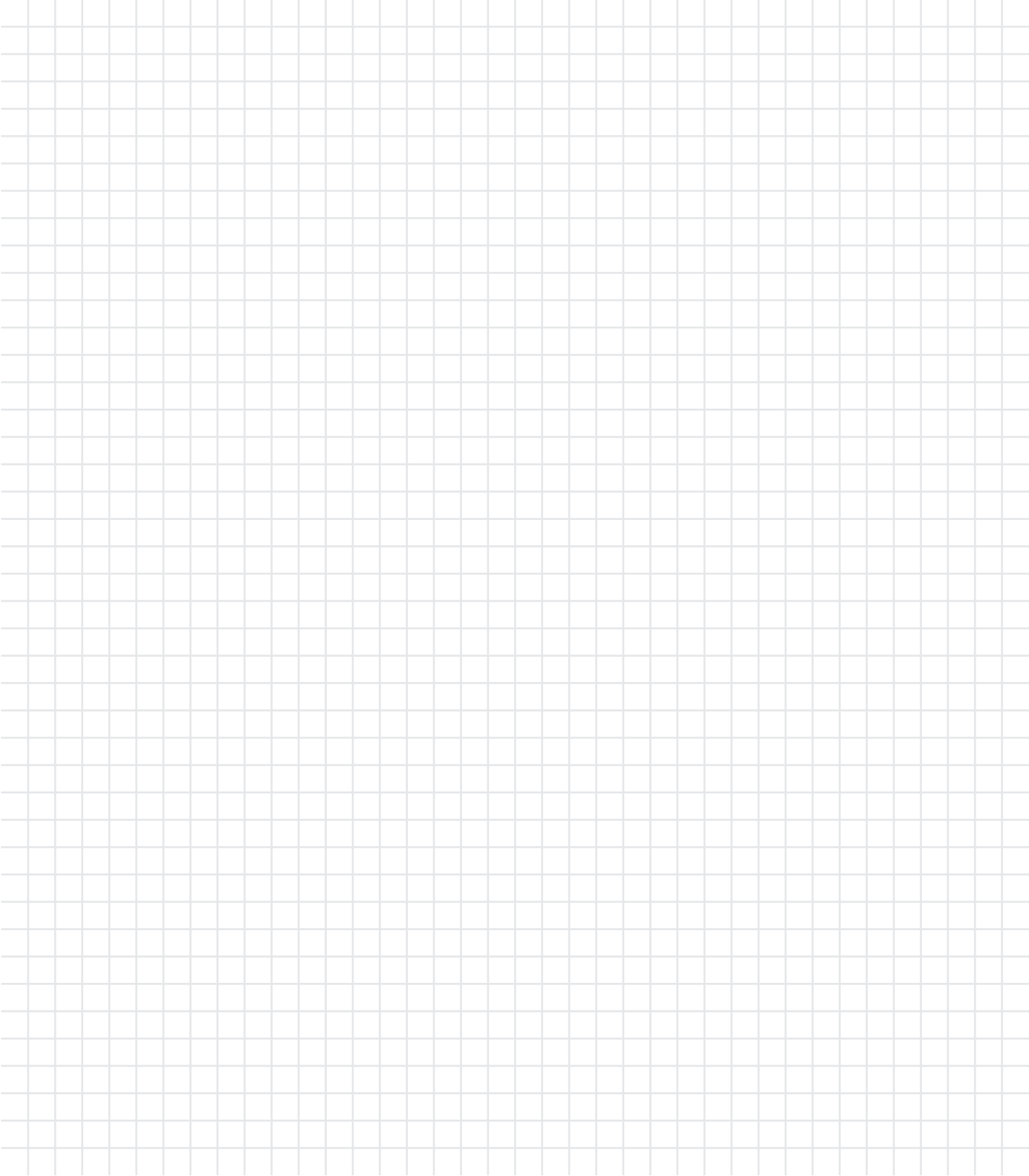

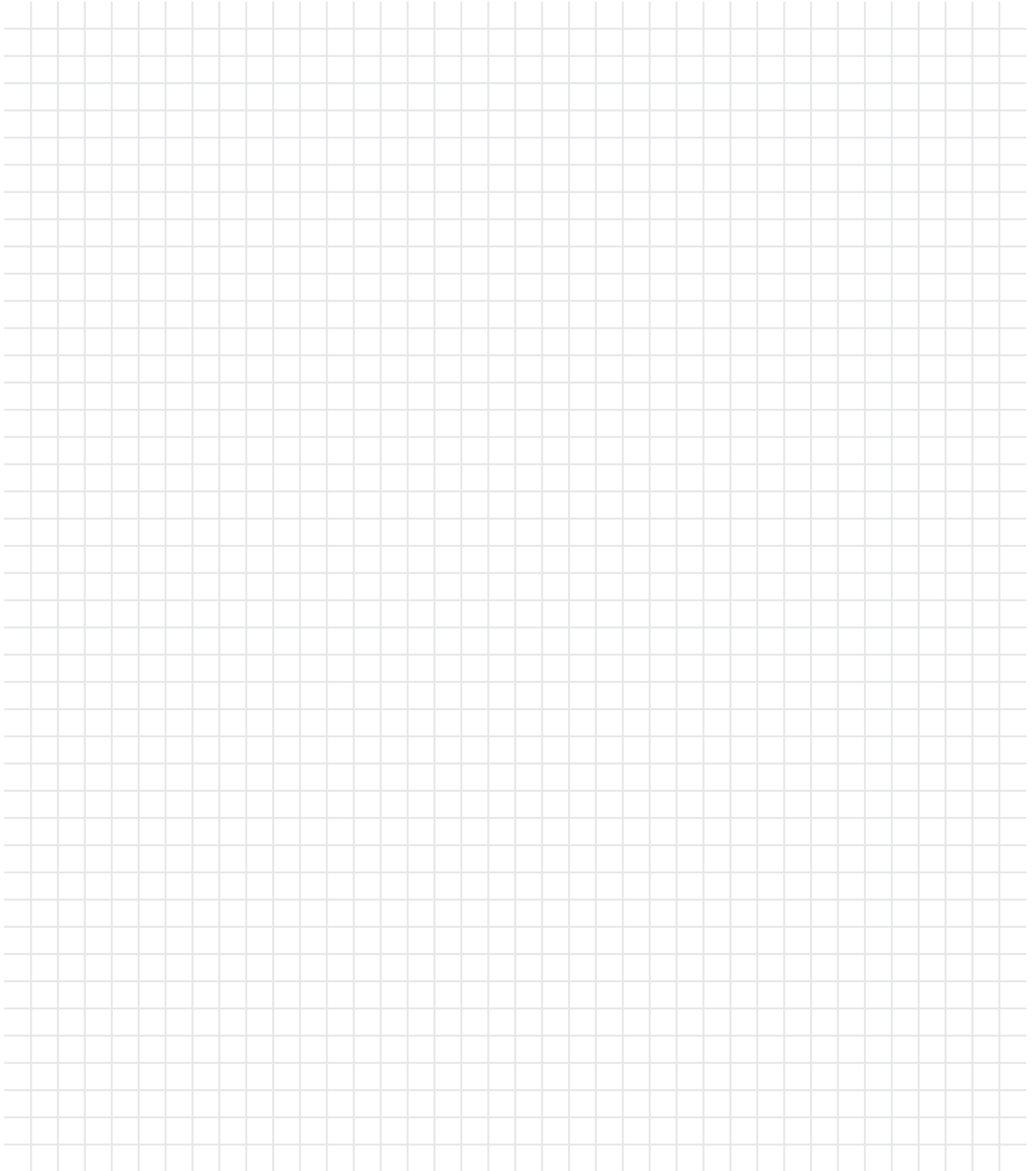



All previous catalogues and price lists are no longer valid with the issue of this catalogue. Errors, misprints, model and price changes and technical modifications are reserved. We deliver based on our terms of delivery and payment. Our products comply with the European light norm EN60598. Products with the ENEC test mark are conforming to the guide line 2006/95/EG. Products with additional safety remarks (e.g protection class, IP) are identified within the product family with the relevant symbol and number. The content of this catalogue is protected under copyright law for EGLO Leuchten GmbH. All rights reserved. Our specific written consent must be obtained before using any illustrations and texts. The pictures are 4C prints and may differ from the original. The product pictures and ambiances in this catalogue can deviate from reality, and they do not necessarily concur with the usual application of the product. EGLO does not assume liability for the correctness, completeness or the application depiction of the products and/or the product information.

Design, layout and composition:

EGLO GmbH, 6136 Pill - AUSTRIA

Print: Samson Druck GmbH, 5581 St. Margarethen - AUSTRIA

Pictures: EGLO, Adobe Stock, istockphoto.com, shutterstock.com

Mit diesem Katalog verlieren alle vorhergehenden Kataloge und Preislisten ihre Gültigkeit. Irrtümer, Druckfehler, Modell- und Preisänderungen sowie technische Änderungen vorbehalten. Wir liefern zu unseren Liefer- und Zahlungsbedingungen. Unsere Produkte entsprechen der europäischen Leuchtnorm EN 60598. Produkte mit dem ENEC Prüfzeichen sind konform mit der Richtlinie 2006/95/EG. Produkte mit weiteren Sicherheitshinweisen (zB. Schutzklasse, IP) sind mit Symbol und Zahl bei der Produktfamilie ausgezeichnet. Der Inhalt dieses Kataloges ist für die EGLO Leuchten GmbH urheberrechtlich geschützt. Alle Rechte sind vorbehalten. Bilder und Texte dürfen nicht ohne vorherige ausdrückliche, schriftliche Genehmigung verwendet werden. Die Abbildungen sind 4C Drucke und können vom Original abweichen.

Die Katalogbilder und die gezeigten Darstellungen der Produkte können von der Wirklichkeit abweichen und nicht den üblichen Produktanwendungen entsprechen. EGLO übernimmt keine Haftung für die Richtigkeit, Vollständigkeit und Anwendungsdarstellung der Produkte und Produktinformationen.

Gestaltung, Layout und Satz:

EGLO GmbH, A-6136 Pill - AUSTRIA

Druck: Samson Druck GmbH, 5581 St. Margarethen - AUSTRIA

Bilder: EGLO, Adobe Stock, istockphoto.com, shutterstock.com

Le présent catalogue remplace tous les catalogues et tarifs précédents.

Sous réserve d'erreurs, de fautes d'impression, de modification des modèles et de changement de prix et de technique. Nous livrons sur la base de nos conditions de livraison et de paiement. Nos produits sont conformes aux normes européennes EN 60598 et portent le marquage CE. Les produits portant la marque ENEC sont conformes à la Directive 2006/95/EG. Les produits portant d'autres indications de sécurité (par exemple classe de protection, IP) sont identifiés par le symbole et le nombre correspondants dans la famille de produits.

Le contenu du présent catalogue est protégé pour la société EGLO Leuchten GmbH par un copyright. Tous droits réservés. Toute reproduction d'images et du texte est interdite sans autorisation explicite par écrit préalable. Les images sont imprimées en 4C et peuvent différer de l'original.

Les images des produits et les ambiances dans le catalogue peuvent dévier de la réalité et ne sont pas nécessairement en ligne avec l'usage habituel du produit. EGLO n'engage pas sa responsabilité sur la justesse des images et sur les informations relatives à l'usage pouvant être fait des produits.

Conception, maquette et composition :

EGLO GmbH, A-6136 Pill - AUSTRIA

Presso: Samson Druck GmbH, 5581 St. Margarethen - AUSTRIA

Images: EGLO, Adobe Stock, istockphoto.com, shutterstock.com

06-2022

EGLO

Leuchten GmbH

Heiligkreuz 22
AT - 6136 Pill

TEL: +43 (0) 5242 6996
FAX: +43 (0) 5242 6996-972

www.eglo.com
info@eglo.com



my light | my style