

Suspensions, Ceiling lamps, Wall lamps,
Table lamps, Floor lamps, Systems, Spotlights
and Tracks, Recessed lights, Outdoor lamps.
Selection for designers and architects.

Light is about moments.

ideal lux. selection

Ideal Lux s.r.l.

Headquarter

Via Taglio Destro, 32
30035 Mirano — Venezia
P.I. / C.F. 02420040277
8.00 - 12.00 / 13.30 - 17.30

Warehouse

Via delle Industrie, 8/D
30036 Santa Maria di Sala — Venezia
8.00 - 12.00 / 13.00 - 17.00

E info@ideal-lux.com

T +39 041 5790500

F +39 041 8872349

Ig: [ideal.lux](#)

Fb: [Ideal Lux](#)

www.ideal-lux.com

Copyright 2024 © IDEAL LUX S.r.l.

All rights reserved

Tutti i diritti sono riservati

This catalogue is a selection of our products designed for designers, architects, and lighting professionals. It has been conceived as a resource to guide you in your creative journey, offering inspiration and tools to quickly identify options that best suit your visions.

Our experience in balancing form and function is reflected in every product, offering lighting solutions that speak to both contemporary aesthetics and timeless functionality.

The Ideal Lux team is ready to accompany you on this journey.

Raffaele Strano, CEO

A handwritten signature in black ink, appearing to read 'Raffaele Strano', written in a cursive style.

Light offers warmth, shelter, comfort, intimacy. Ideal Lux celebrates it through its products, essential lighting fixtures. The challenge it faces every day is to unite the design of the products and the immateriality of light to create personalized and unique spaces which can tell the story of those who animate them.

Anyone involved in the design of living spaces can find in Ideal Lux the ideal partner to define areas capable of telling the lives of their clients, creating contexts in which everyone becomes the protagonist of their own story. Environments that best represent the personality and taste of those who inhabit them.

Light is a form of pure energy that brings joy and not only allows us to see but also influences our mood and well-being.

Attention to people is central, which is why every lighting system is designed to enhance every moment and every place, giving the opportunity to express what is important to each of us.

Nowadays, light is no longer just functional for illuminating a space but elevates it, fully expressing the essence that the designer has sought to impart through geometries and materials.

Every space, when infused with the right light, takes on a deeper, more authentic, and vital meaning, recounting the different moments of our daily lives.



LIGHT IS

ABOUT MOMENTS

IDEAL LUX

PRESENTATION

Since 1974, Ideal Lux has been passionately dedicated to creating lighting furnishing accessories capable of satisfying every need. The *Selection* collection gathers some of the more than 3700 products offered by the company, designed to embrace a modern and design-oriented taste.

LIGHT TALES

BOTH THE LIGHT
AND THE MOMENTS
CAN BE
FLEETING.
THE LIGHT
THAT DISAPPEARS
BY TURNING OFF
THE SWITCH,
THE MOMENTS
THAT PASS
IN THE BLINK
OF AN EYE.
ALL THIS
MAKES THEM
UNFORGETTABLE.

Attention and dedication to the customer are the very foundation of Ideal Lux. Our Customer Care represents a fundamental pillar within the company, with an emphasis on reliability as our core value. We place the needs of people at the top of our priorities.

For us, quality cannot exist without a warranty. We have extended the coverage to 5 years on all our lighting furnishing accessories, to ensure the highest standards in the products and services offered at all times.





WALL LAMPS
P. 150

SECTION INDEX

DATASHEETS
P. 481



TABLE LAMPS
P. 196

CEILING LAMPS
P. 120



SUSPENSIONS
P. 14



FLOOR LAMPS
P. 236



SECTION INDEX

DATASHEETS
P. 481



RECESSED LIGHTS
P 350



SPOTLIGHTS AND TRACKS
P 286



SYSTEMS
P 286



OUTDOORS
P 378

ALPHABETICAL
INDEXINDOORS → IN
OUTDOORS → OUT**AGOS** OUT
→ Floor 380**ANDROMEDA** OUT
→ Wall 388**BEAN** IN
→ Wall 152**BENTO** IN
→ Recessed Light 352**BIRDS** IN
→ Suspension 488
→ Ceiling 122
→ Wall 489
→ Table 489
→ Floor 238**CLIP** IN
→ Wall 156**COVER** IN
→ Wall 160**DELTA** IN
→ Wall 166**DIESIS** IN
→ Suspension 492
→ Table 492
→ Floor 244**DISPLAY** IN
→ Projectors 288**DJAMBE** OUT
→ Floor 392**DORSALE** IN
→ Floor 252**DOT** IN
→ Ceiling 126**DYNAMITE** IN
→ Suspension 495
→ Ceiling 130**EGO** IN
→ System 296**EOS** IN
→ Projectors 316**EQUINOXE** IN
→ Suspension 16
→ Wall 497
→ Floor 258**ESSENCE** IN
→ Suspension 498
→ Wall 172**FADE** IN
→ Suspension 20**FILO** IN
→ Suspension 26
→ Wall 500
→ Table 501
→ Floor 264**FLUO** IN
→ System 324**FLY** IN
→ Ceiling 136**FOCUS** IN
→ Wall 178**FOX** IN
→ Projectors 330**FRAME** IN
→ Suspension 30
→ Ceiling 142
→ Floor 508**FUTURA** IN
→ Table 198
→ Floor 508**GAME** IN
→ Recessed Light 358**GEMINI** IN
→ Suspension 38
→ Ceiling 510**GUN** OUT
→ Ceiling 596
→ Wall 400**IPOTESI** OUT
→ Floor 408**JEDI** OUT
→ Floor 414**LIKA** IN
→ Recessed Light 364**LINK** IN
→ Binario 580**LINUS** IN
→ System 334
→ Wall 588**LOLITA** OUT
→ Table 420**LOOK** IN
→ Suspension 44
→ Ceiling 511
→ Wall 512
→ Floor 512
→ Track mounted 513

MAPA BIANCO	IN	PIVOT	IN	VEGA	OUT
→ Suspension	52	→ Table	218	→ Floor	472
→ Ceiling	515	QUICK	IN	VIRUS	IN
→ Wall	515	→ Projectors	340	→ Recessed Light	374
→ Table	204	SET UP	IN	YOKO	IN
MINT	IN	→ Suspension	532	→ Suspension	537
→ Suspension	58	→ Ceiling	532	→ Table	230
MIX UP	IN	→ Wall	186	→ Floor	280
→ Suspension	62	→ Table	224	ZIG ZAG	IN
→ Ceiling	518	→ Floor	276	→ Wall	190
→ Floor	518	SIRIO	OUT		
MOBY	IN	→ Floor	428		
→ Suspension	74	SOLE	OUT		
NEMO	IN	→ Suspension	599		
→ Suspension	80	→ Floor	436		
NOVA	IN	SPIKE	IN		
→ Recessed Light	368	→ Ceiling	146		
ONION	IN	STARLIGHT	OUT		
→ Suspension	86	→ Projectors	442		
ORACLE SLIM	IN	STYLE	OUT		
→ Suspension	94	→ Wall	602		
→ Ceiling	523	→ Floor	448		
OZ	IN	TAURUS	OUT		
→ Suspension	102	→ Recessed Light	454		
→ Ceiling	524	TECHO	OUT		
→ Wall	525	→ Ceiling	460		
→ Table	210	TESI	IN		
PERLAGE	IN	→ System	346		
→ Suspension	108	TESLA	OUT		
→ Ceiling	528	→ Floor	466		
→ Wall	530	ULTRATHIN	IN		
→ Table	530	→ Suspension	114		
→ Floor	270				
PIANO	IN				
→ Wall	182				

SUSPENSIONS

LOVING GAZE,
MOIST EARTH,
WISE HANDS,
COOL WATER,
SHINING LEAVES,
VIBRANT LIGHT,
LIT LAMP,
FALLING DROPS,
LUSH PLANTS.





Index

↳

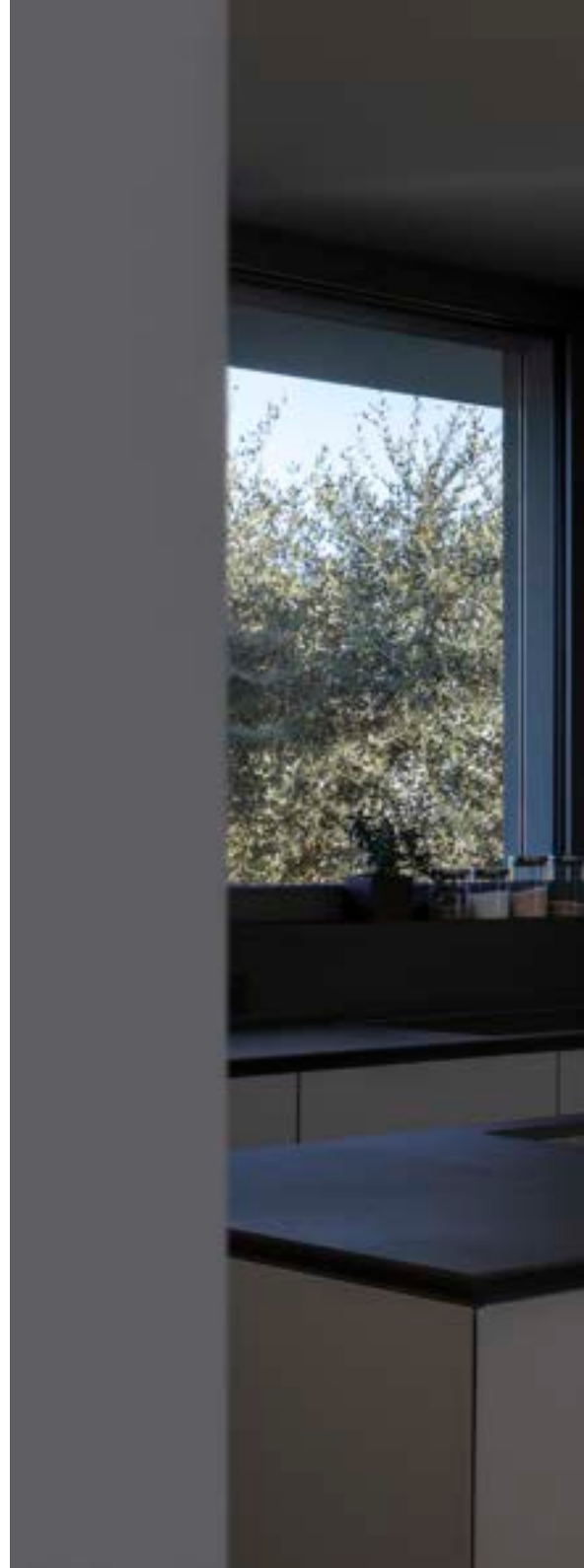
16	Equinox
20	Fade
26	Filo
30	Frame
38	Gemini
44	Look
52	Mapa Bianco
58	Mint
62	Mix Up
74	Moby
80	Nemo
86	Onion
94	Oracle Slim
102	Oz
108	Perlage
114	Ultrathin

DATASHEETS ONLY	488	Birds
	492	Diesis
	495	Dynamite
	498	Essence
	532	Set Up
	537	Yoko



EQUINOXE

Metal frame with chrome
or antiqued brass finish.
Transparent blown glass diffusers.









EQUINOXE

SUSPENSIONS INDOORS

IDEAL LUX



FADE

Metal ceiling rose and frame.
Clear blown glass shade with
galvanic nuance. White acid-etched
inner blown glass diffuser.
Black PVC cable. Shade colors:
clear with amber nuance, chrome
or copper.













FILO

Powder coated or plated metal base and bodies. Black PVC cables.
Colors: white, black or satin brass.
Models 300801, 300818 and 300825 available with 4 meters of cable.







FILO

SUSPENSIONS

INDOORS

IDEAL LUX



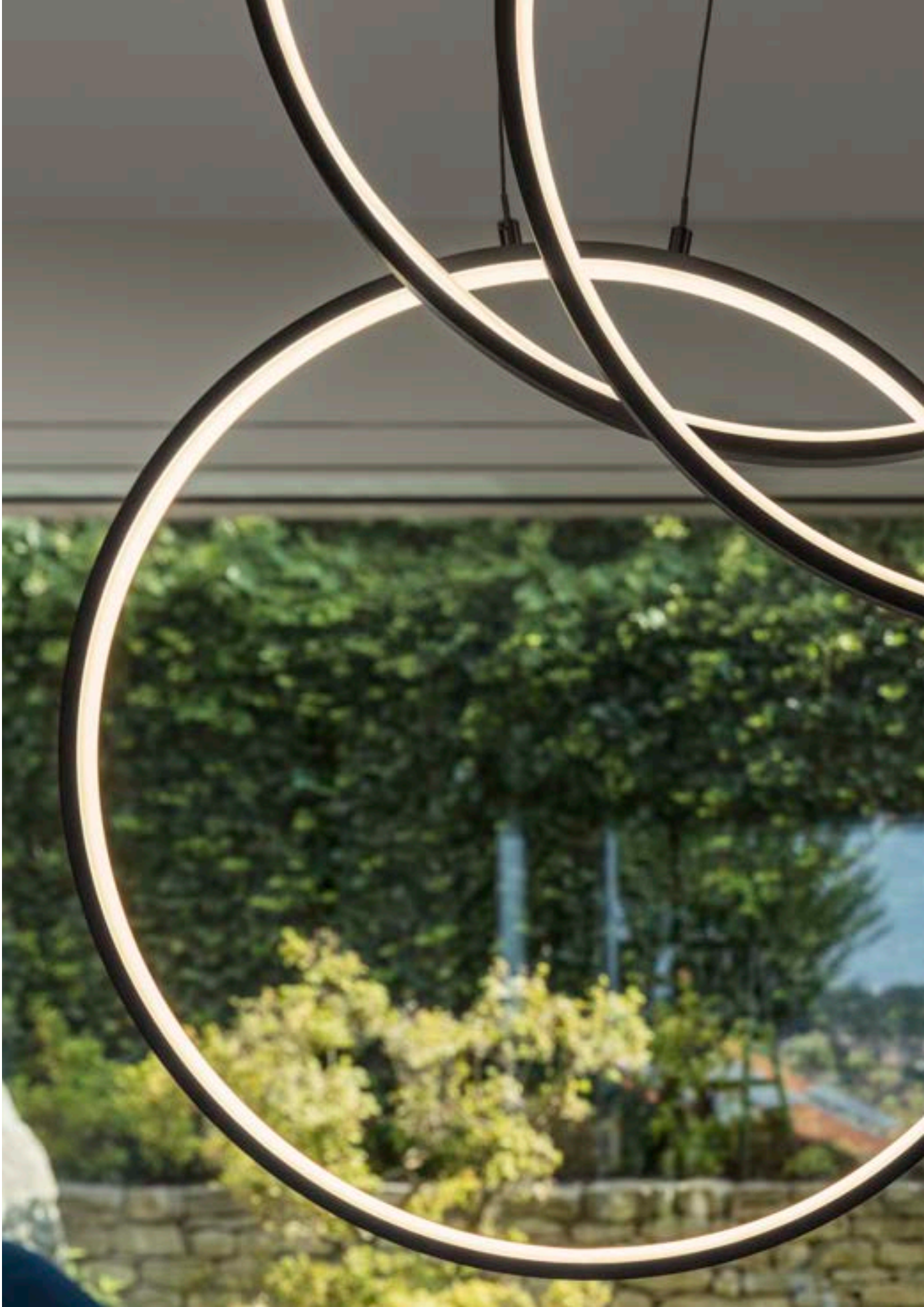




FRAME

Matt white or black varnished metal base and frame. Opal colour plastic diffusers. Adjustable in length cables. Direct light emission.

















GEMINI

Powder coated or plated metal ceiling rose and body.
Opal polycarbonate diffuser.
Clear PVC cable. Available finishes: white, black or brushed brass.
DALI/Push dimmable version available for the models with 810 mm and 610 mm diameter.













LOOK

Metal ceiling rose and diffuser with different finishes. Power cable coated with fabric adjustable in length. It fits replaceable bulbs. Faded chrome version with glass diffuser.

















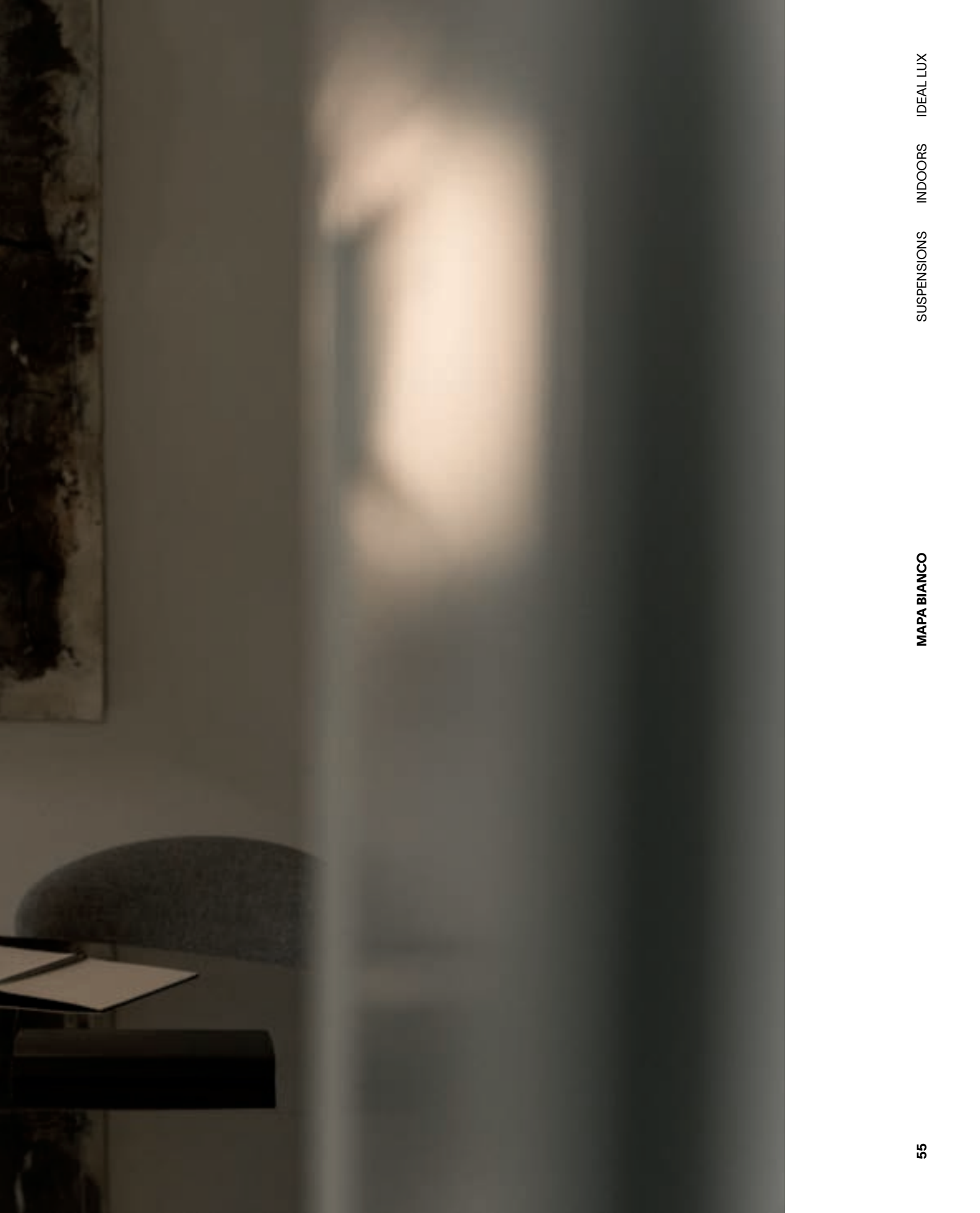


MAPA BIANCO

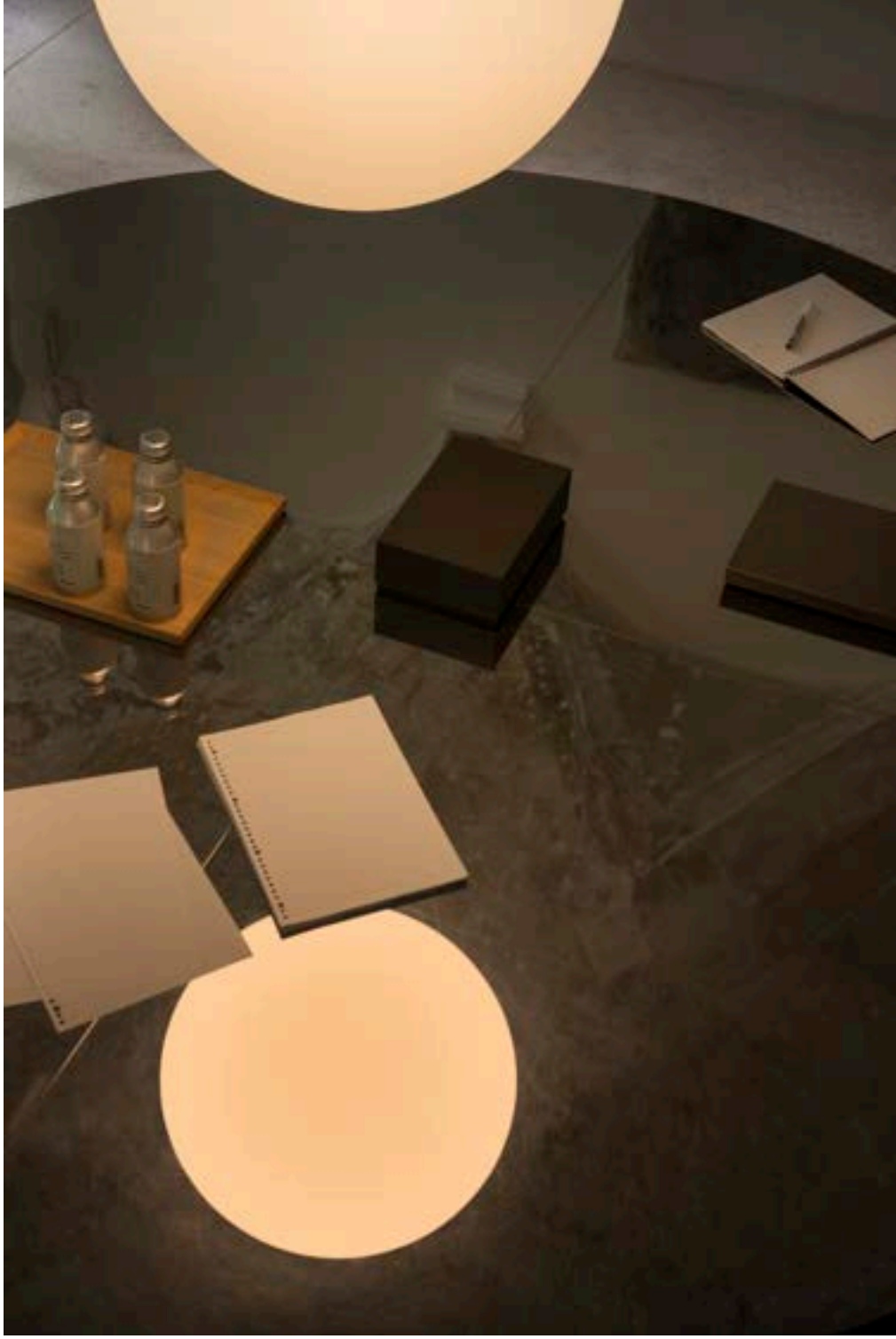
White metal frame. White spherical shape acid-etched blown glass diffuser. Steel cables adjustable in length.













MINT

Metal frame with satin brass finish and matt black ceiling rose. Power cable coated with fabric. Blown glass diffuser with stripes in relief. Available finishes: smoky or green.









MIX UP

Powder-coated varnished metal ceiling cap and interchangeable shades. PVC cable.

Finishes: white or black.























SUSPENSIONS INDOORS IDEAL LUX

MIX UP



MOBY

Metal frame and diffuser
white inside. Available finishes:
white, black or copper.









MOBY

SUSPENSIONS INDOORS IDEAL LUX



MOBY

SUSPENSIONS

INDOORS

IDEAL LUX

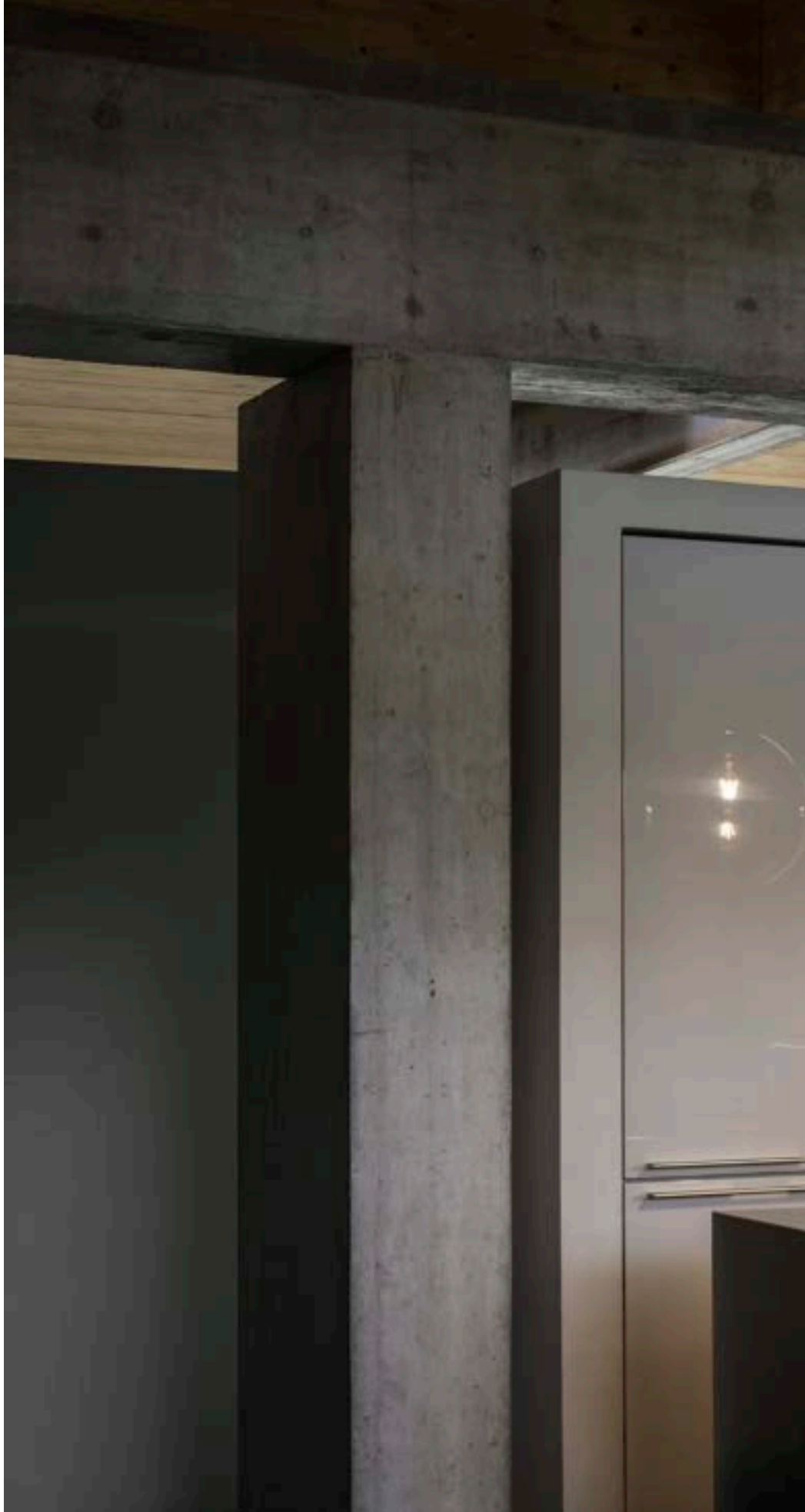




NEMO

Blown glass diffuser. Available with smoky, copper, clear or faded chrome finishes.













ONION

Metal frame finished with
brown varnish with metallic effect.
Power cable coated with fabric.











ONION

SUSPENSIONS

INDOORS

IDEAL LUX







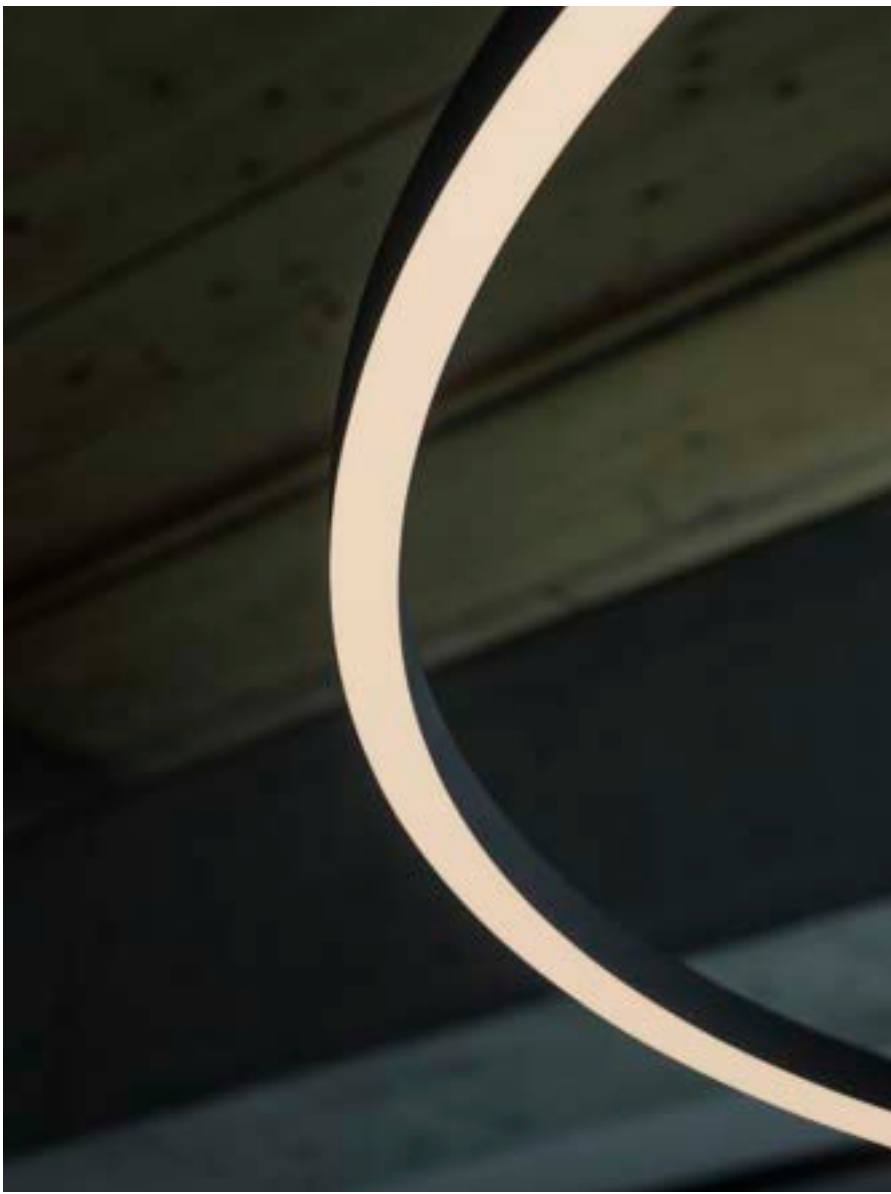


ORACLE SLIM

Suspended lamp consisting of a thin matt white or black painted aluminum frame and opal polycarbonate diffuser. Available in a round version (four different sizes) and a squared one (three different sizes).

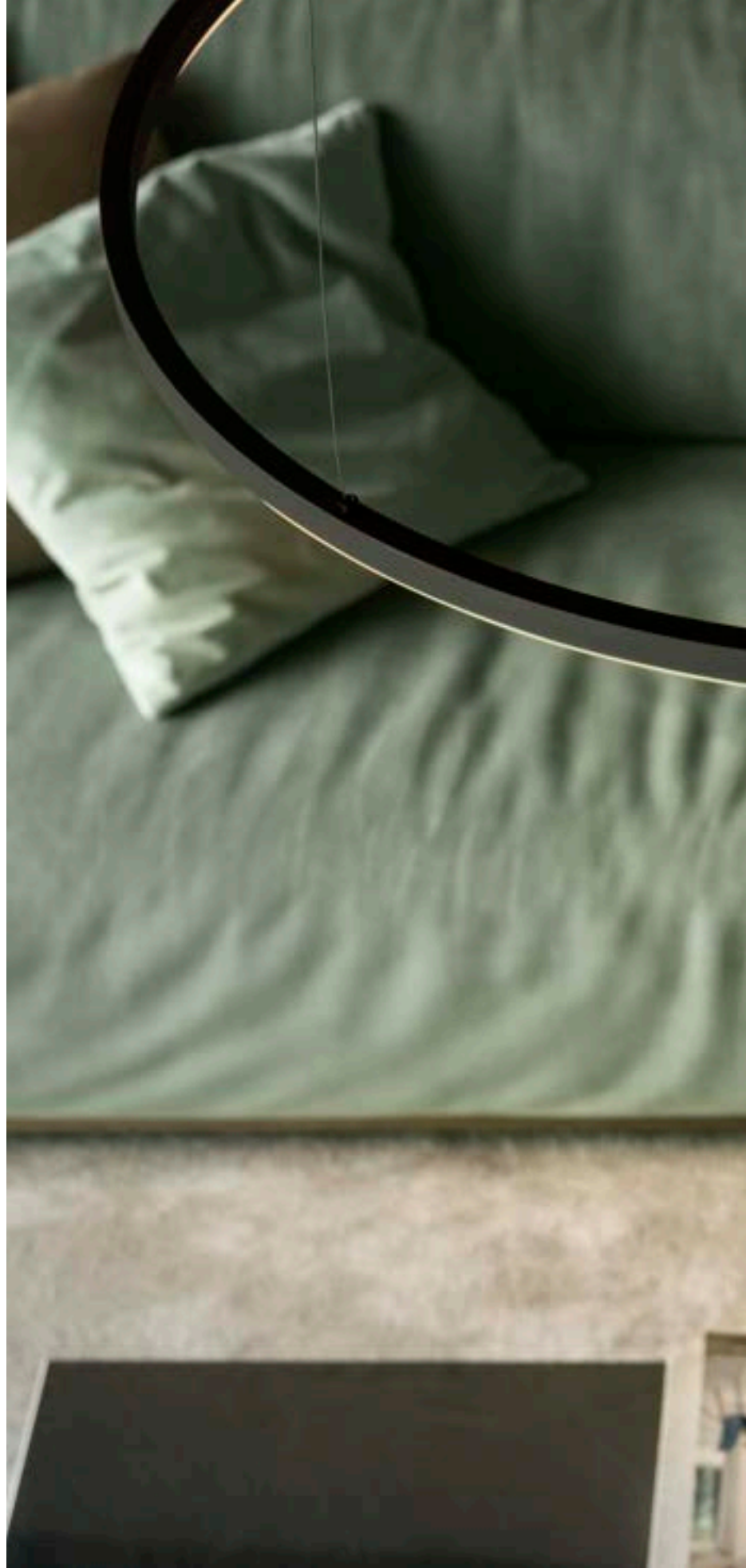














OZ

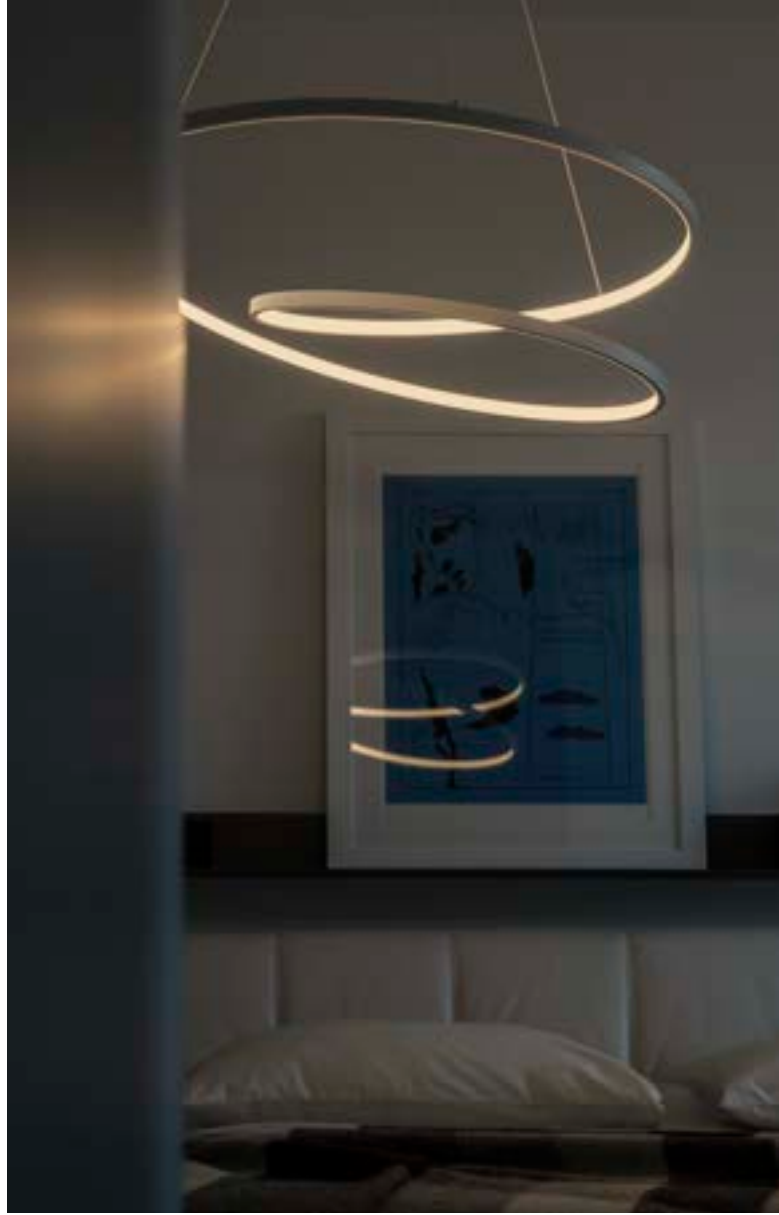


Plated or powder coated metal base and frame. PVC wires. Opal rubber diffuser. Available finishes: white, black or brushed brass. DALI/Push dimmable version available.











PERLAGE

Metal frame with round section linear structure or squared section round structure. Blown glass diffusers. Rubber-coated steel cables. PVC Electrical wire. Finishes: Matt black with amber or smoky Pyrex glasses or satin brass with etched white glasses.













ULTRATHIN

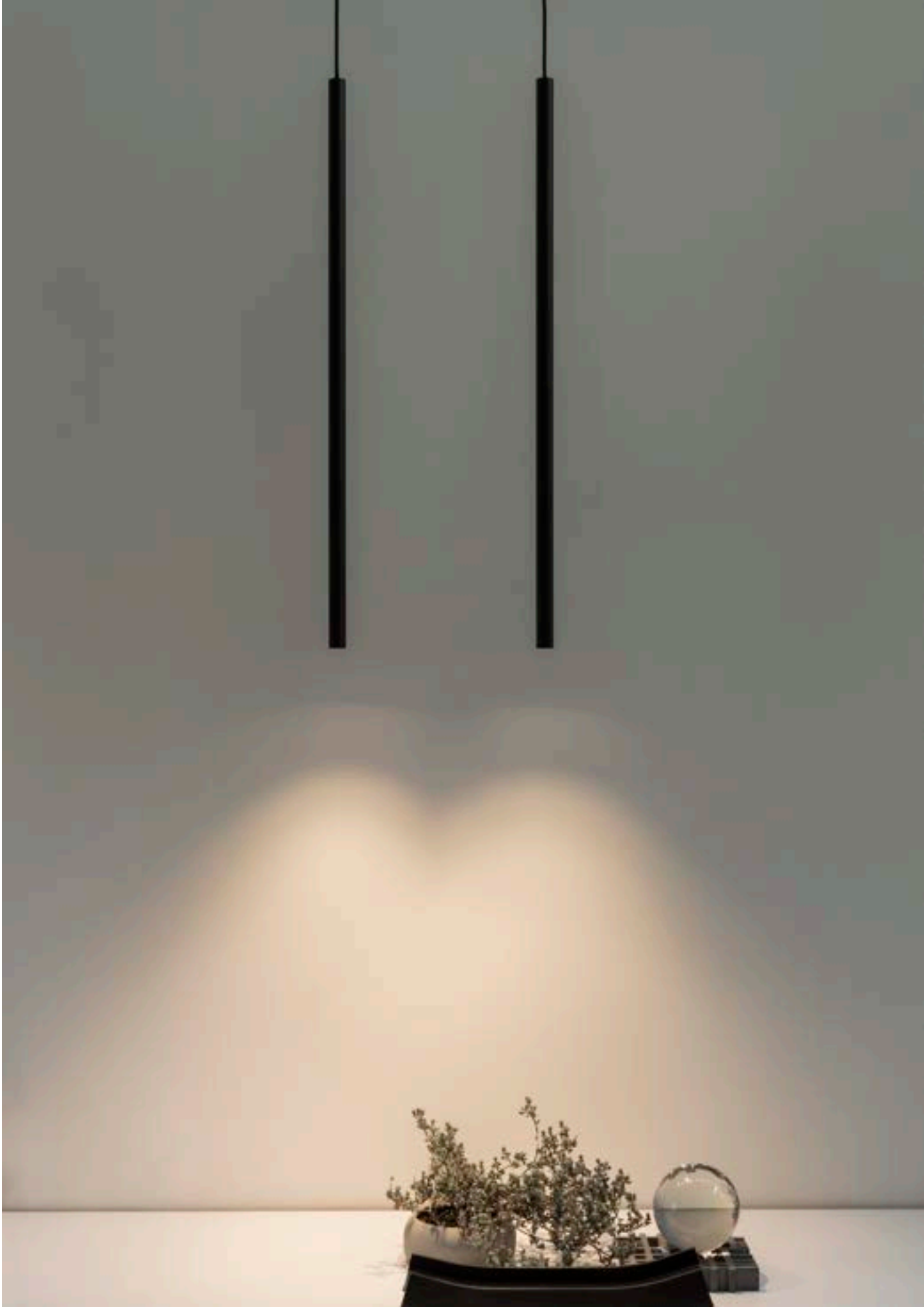
Metal ceiling cup and diffuser plated chrome or with matt white or black varnish finish.
Electrical cable coated with fabric.
DALI/Push dimmable version available for the black round model.













CEILING LAMPS

CHILDREN
LAUGHING,
MESSY
KITCHEN,
FLOURY
HANDS,
SATISFIED
SMILES,
FRAGRANT
DESSERTS
LIT LAMPS,
SHADOWS
DANCING,
MEMORIES
MADE.





Index

↳

122 **Birds**
 126 **Dot**
 130 **Dynamite**
 136 **Fly**
 142 **Frame**
 146 **Spike**

DATASHEETS ONLY

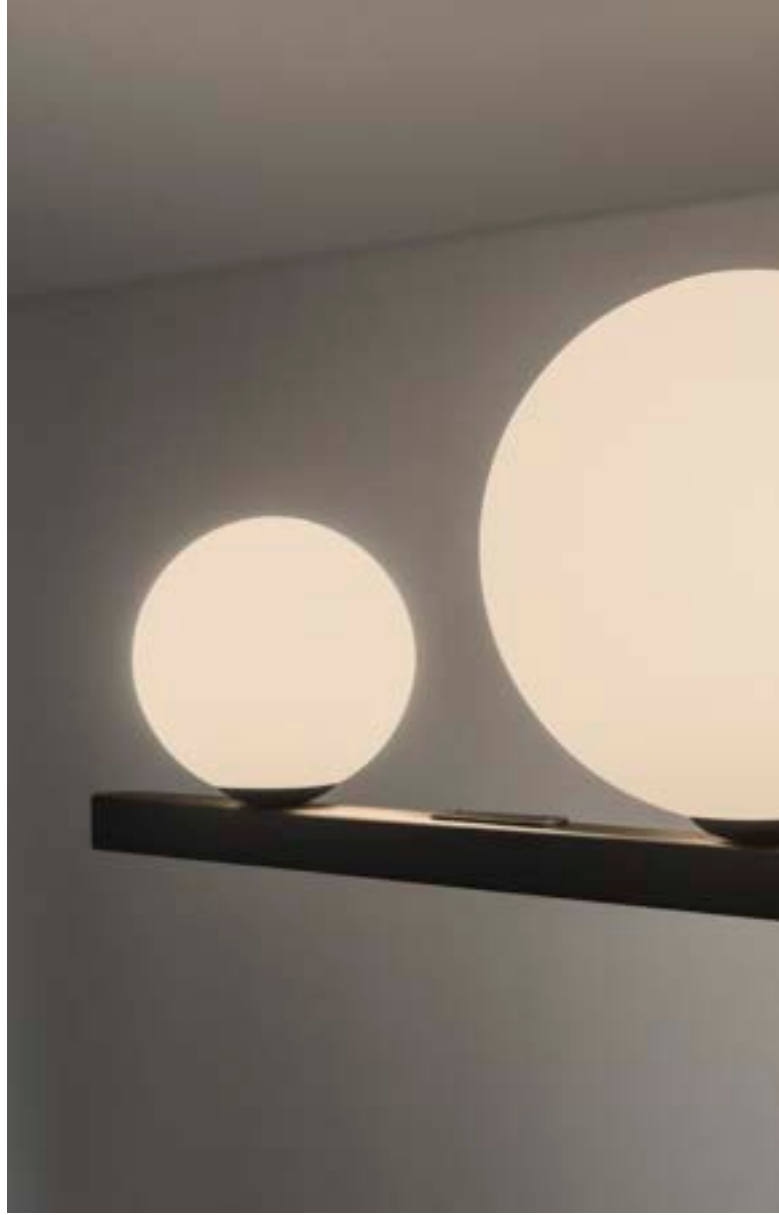
510	Gemini
511	Look
515	Mapa Bianco
518	Mix Up
523	Oracle Slim
524	Oz
528	Perlage
532	Set Up



BIRDS

Varnished metal frame with
satin brass decorative disc.
White acid-etched blown glass
diffusers. Color: matt black
with satin brass detail.







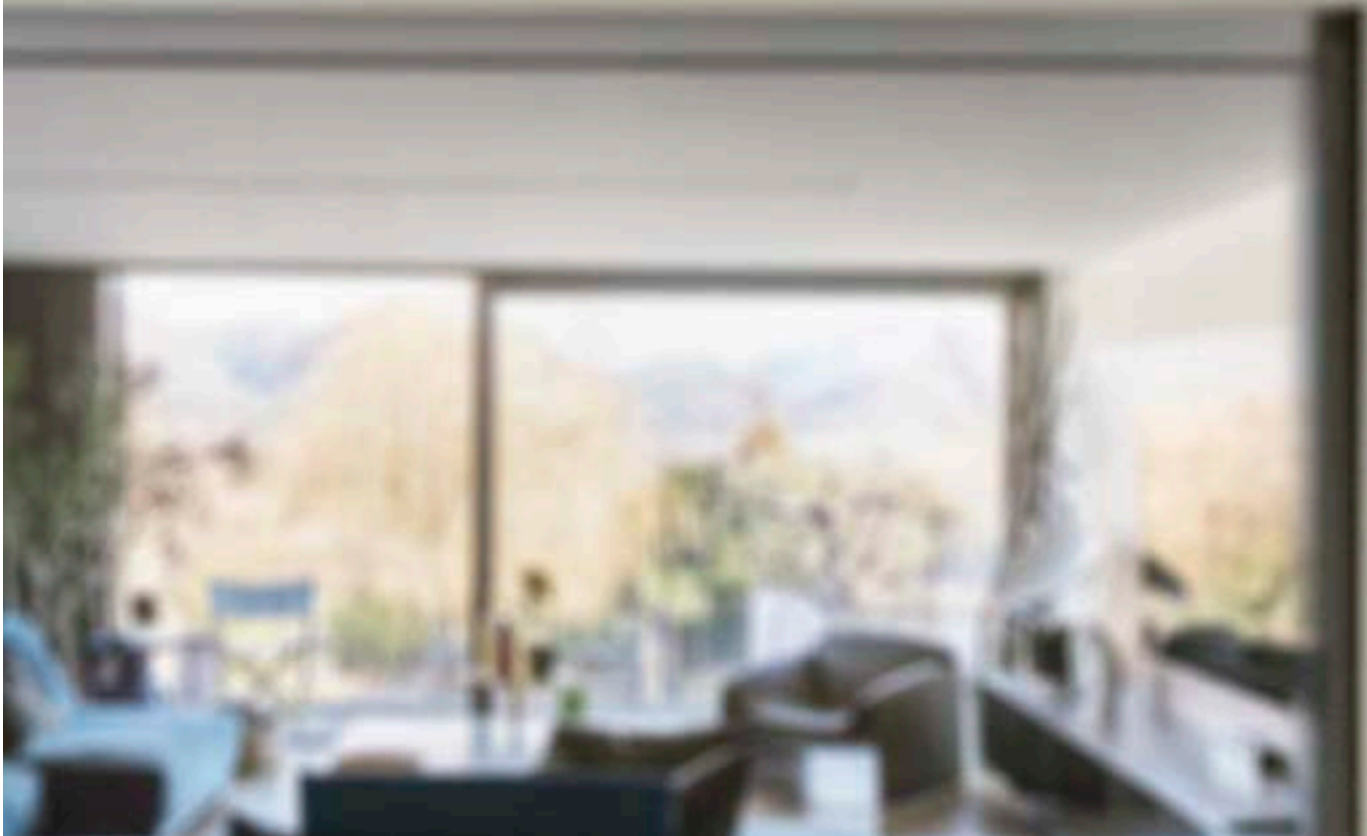


DOT

Powder-coated aluminium base, body and ring. Clear satin acrylic diffuser. Lighting fitting for surface installation. Available finishes: white or black.











DYNAMITE

Powder coated or plated or brushed metal frame. Adjustable diffusers.









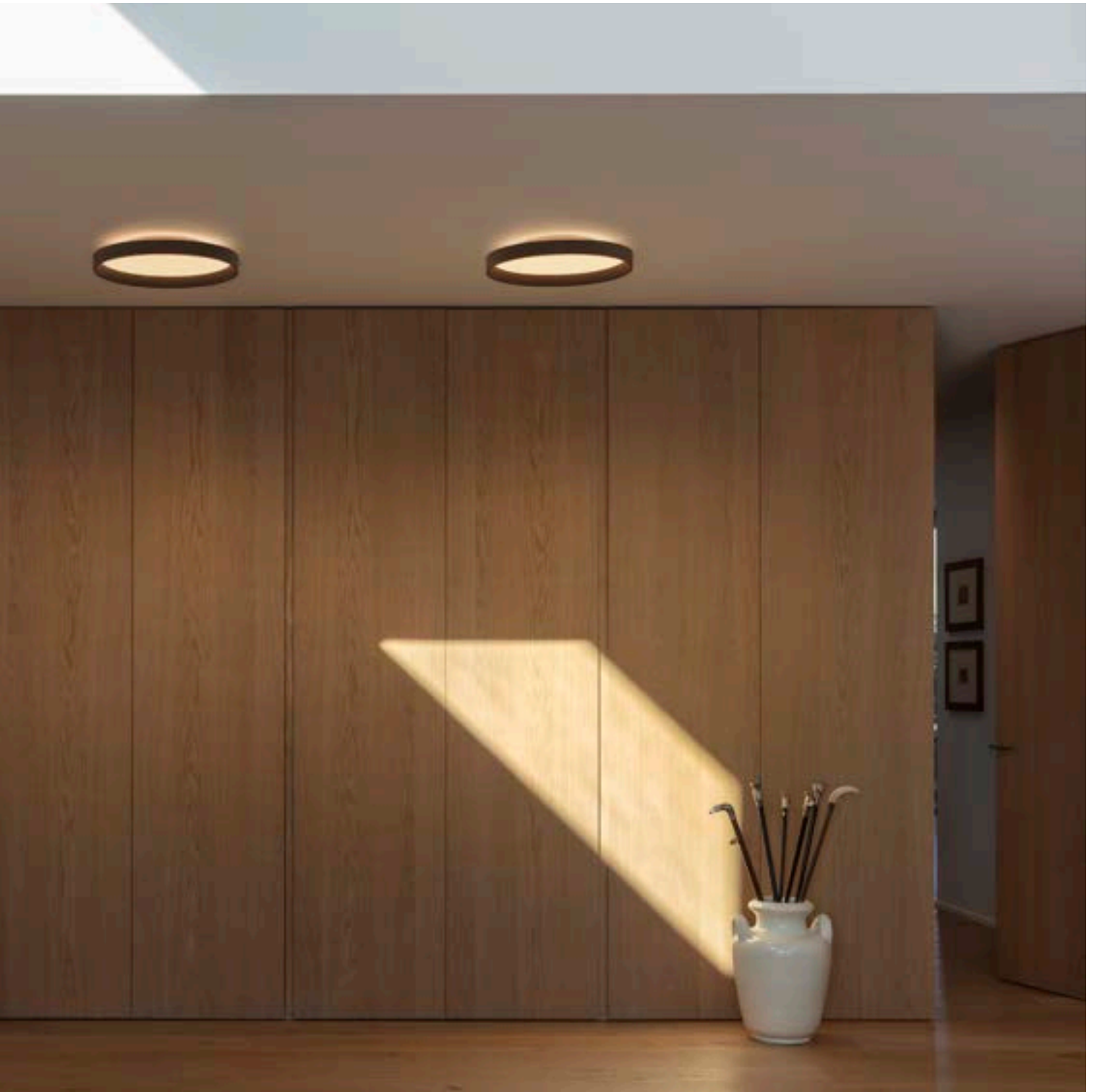




FLY

Family composed by ceiling lamps with circular base, available with four different diameters (350 mm, 450 mm, 600 mm, 900 mm) and also in SLIM version with a more compact height. Powder coated body with white finish RAL 9016 and black finish RAL 9004, recessed optics (FLY PL) or flush (FLY SLIM) with PMMA microprismatic diffuser with glare control (UGR < 19). The lamp is ready to be integrated with the upright accessory module (see page 141) for the indirect light part.











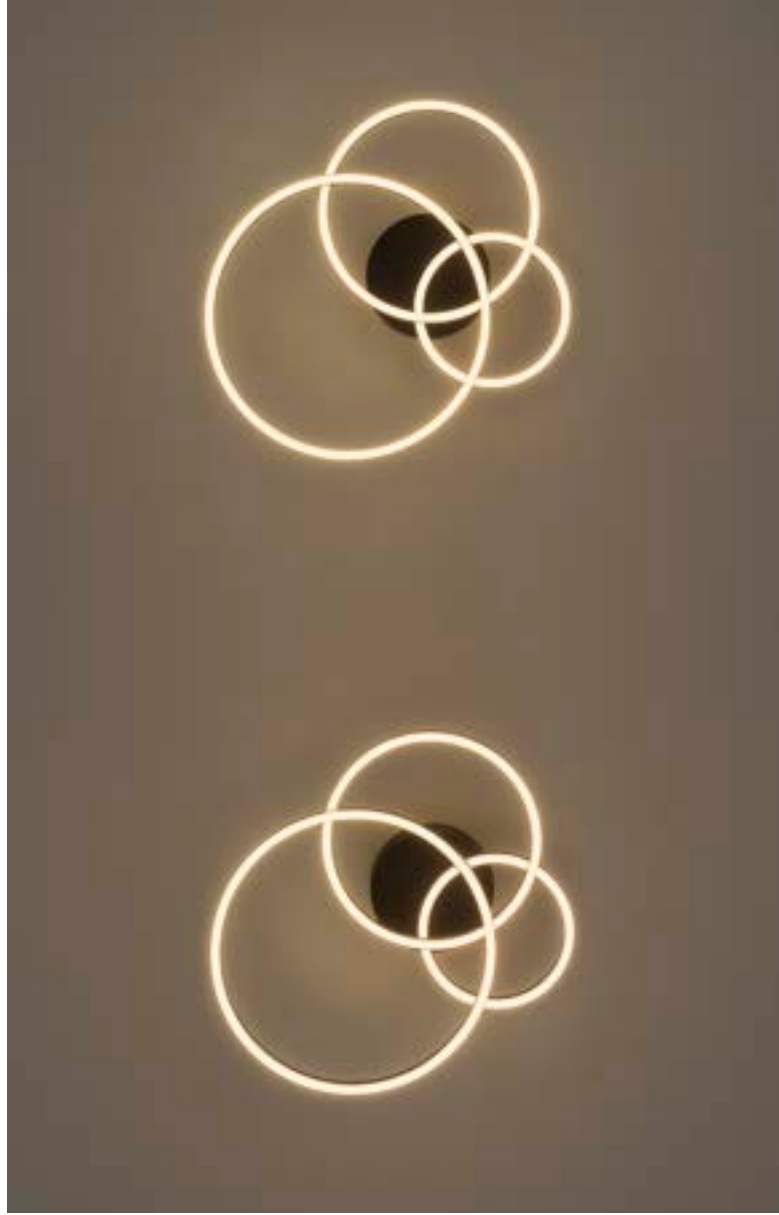




FRAME

Matt white or black varnished metal base and frame. Opal colour plastic diffusers. Direct light emission.





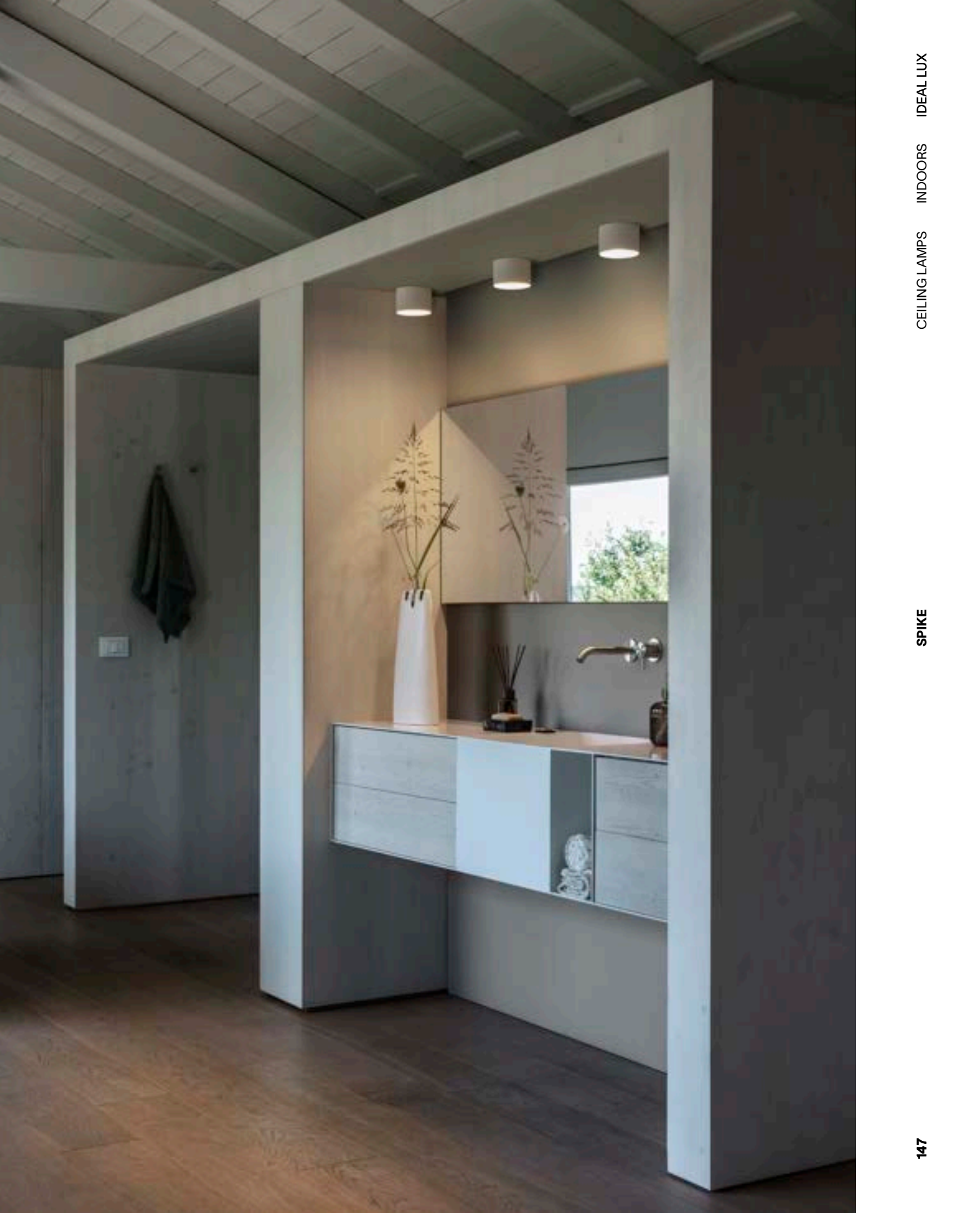




SPIKE

Powder coated or plated
turned aluminum body and base.
Replaceable LED source.
Colors: white, chrome, nickel,
black or satin brass or antique
brass copper.





CEILING LAMPS INDOORS IDEAL LUX

SPIKE





WALL LAMPS

DREAMS
DANCING,
OPEN PAGES,
GENTLE
LIGHT,
WORDS
FLOATING,
NIGHTTIME
EMBRACES,
CRUDLING
SILENCE,
NIGHT
LISTENING,
STORIES
INTERWEAVING,
DREAMS
SOARING.





Index



152 **Bean**
156 **Clip**
160 **Cover**
166 **Delta**
172 **Essence**
178 **Focus**
182 **Piano**
186 **Set Up**
190 **Zig Zag**

DATASHEETS ONLY 489 **Birds**
497 **Equinoxe**
500 **Filo**
588 **Linus**
512 **Look**
515 **Mapa Bianco**
525 **Oz**
530 **Perlage**



BEAN

Directable plated or powder coated metal base and diffuser. White, black, brass or nichel color with black switch and junction.







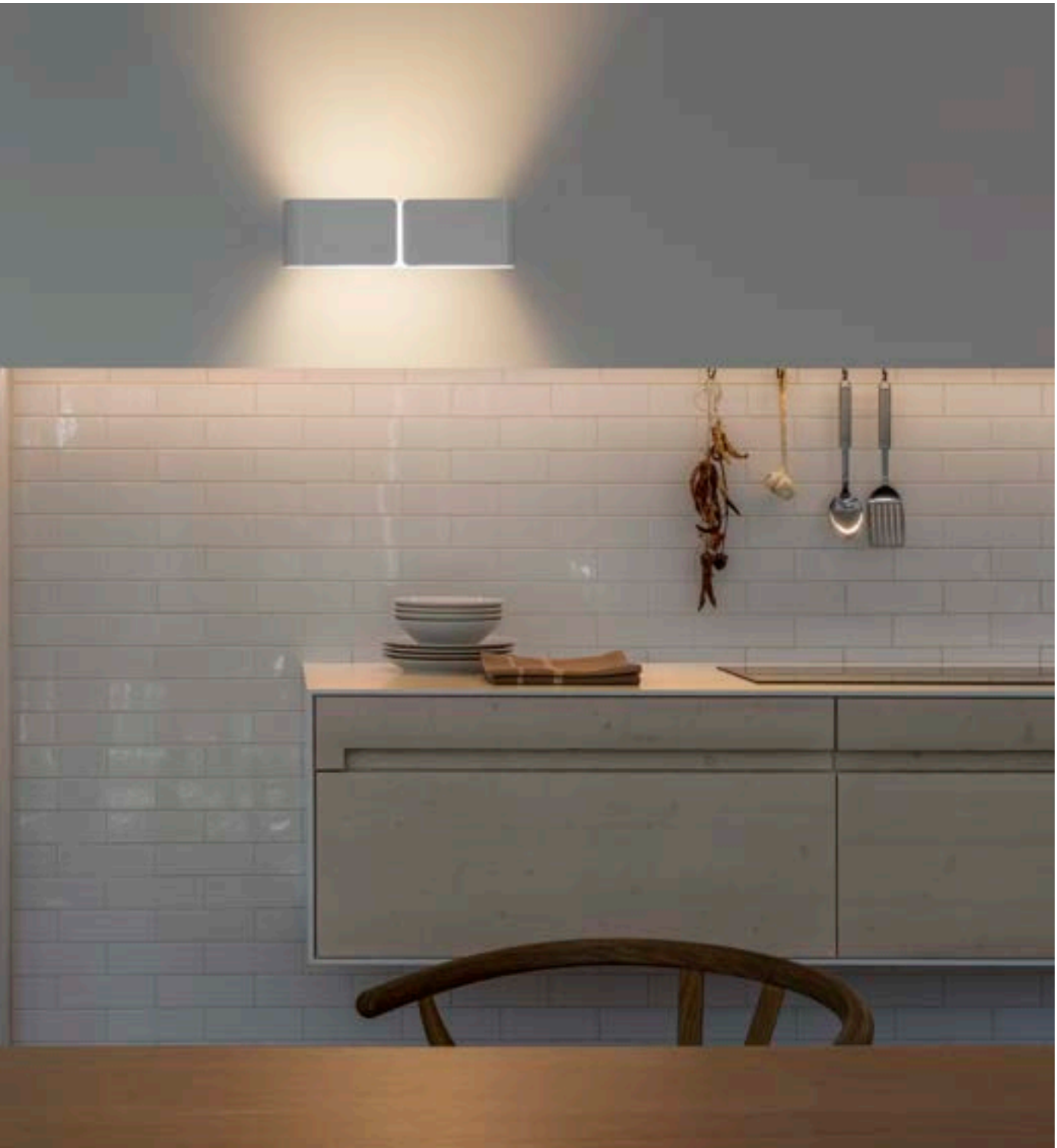




CLIP

Metal sheet body with different finishes. Small size models supplied with sandblasted Pyrex glass diffusers.







CLIP

WALL LAMPS

INDOORS

IDEAL LUX

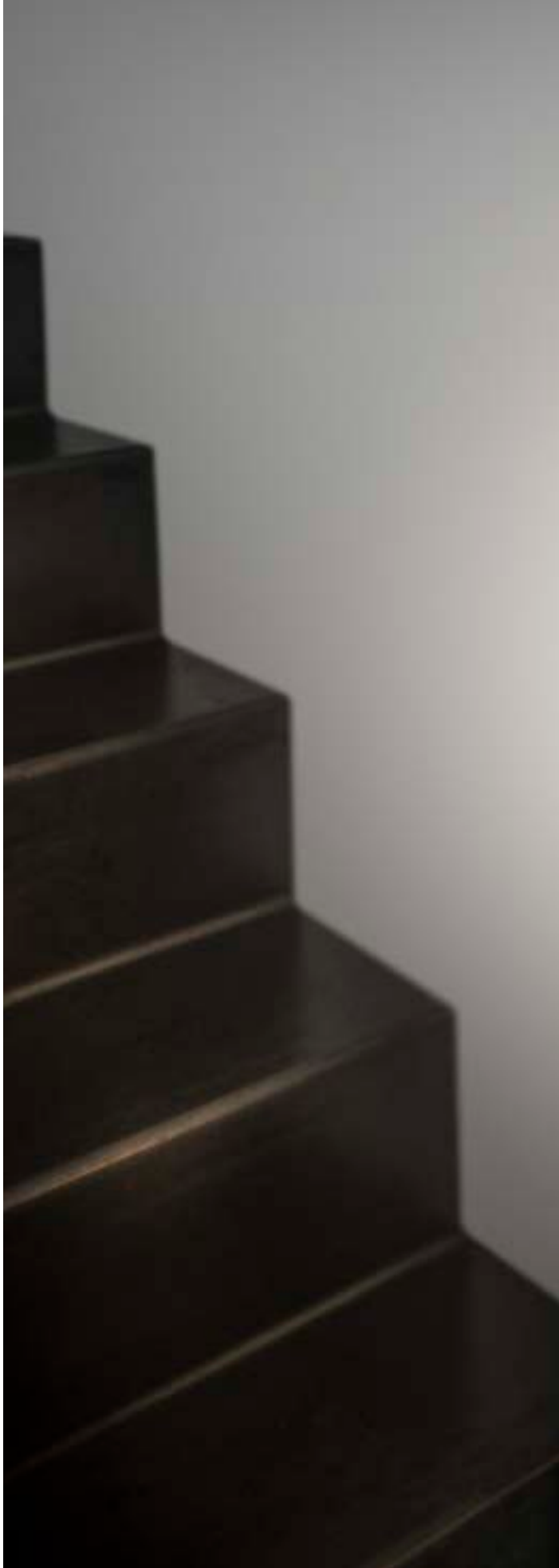


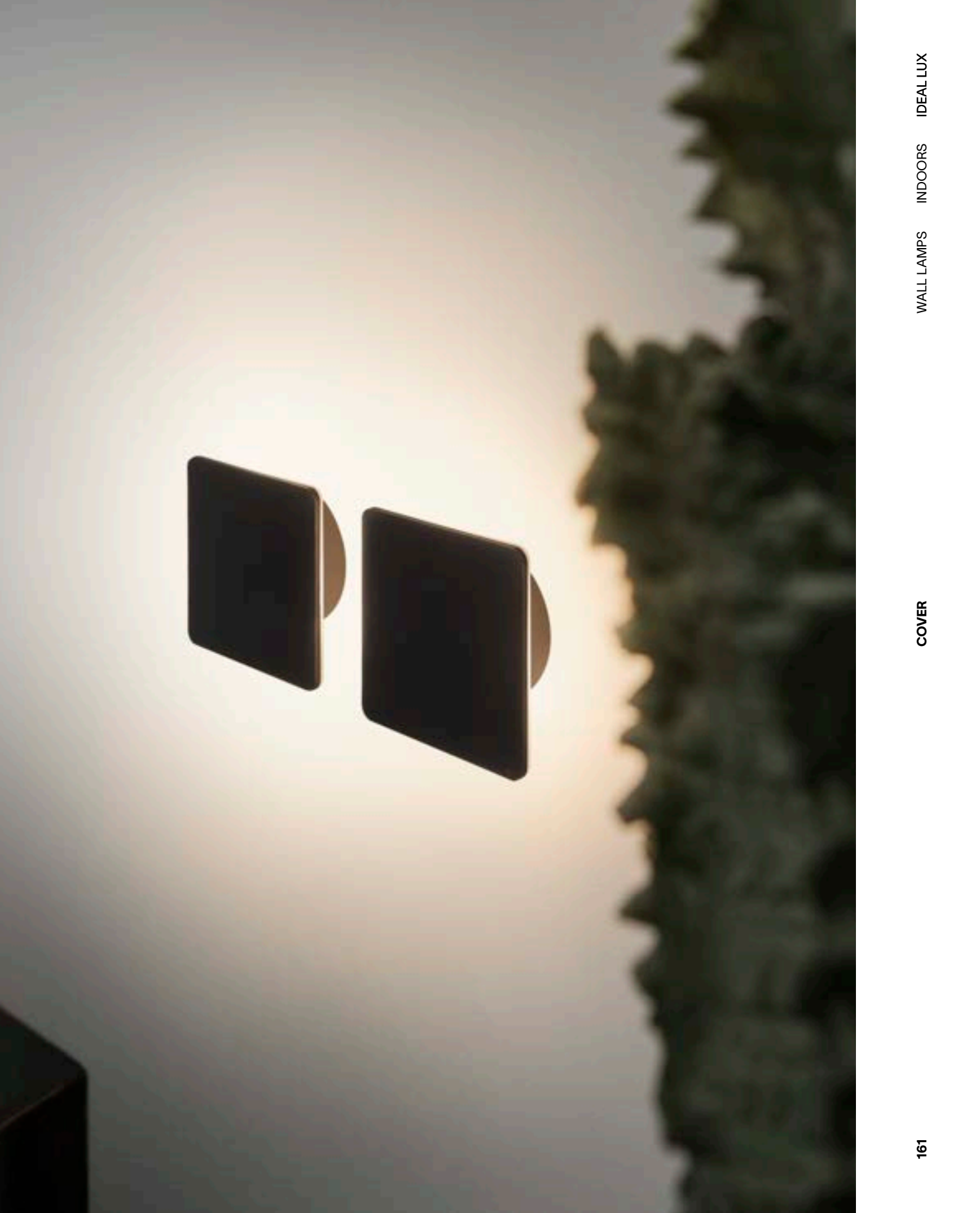




COVER

White or black powder painted aluminum body. Opal color plastic diffuser. Light source made of integrated LED with mirrored light emission.















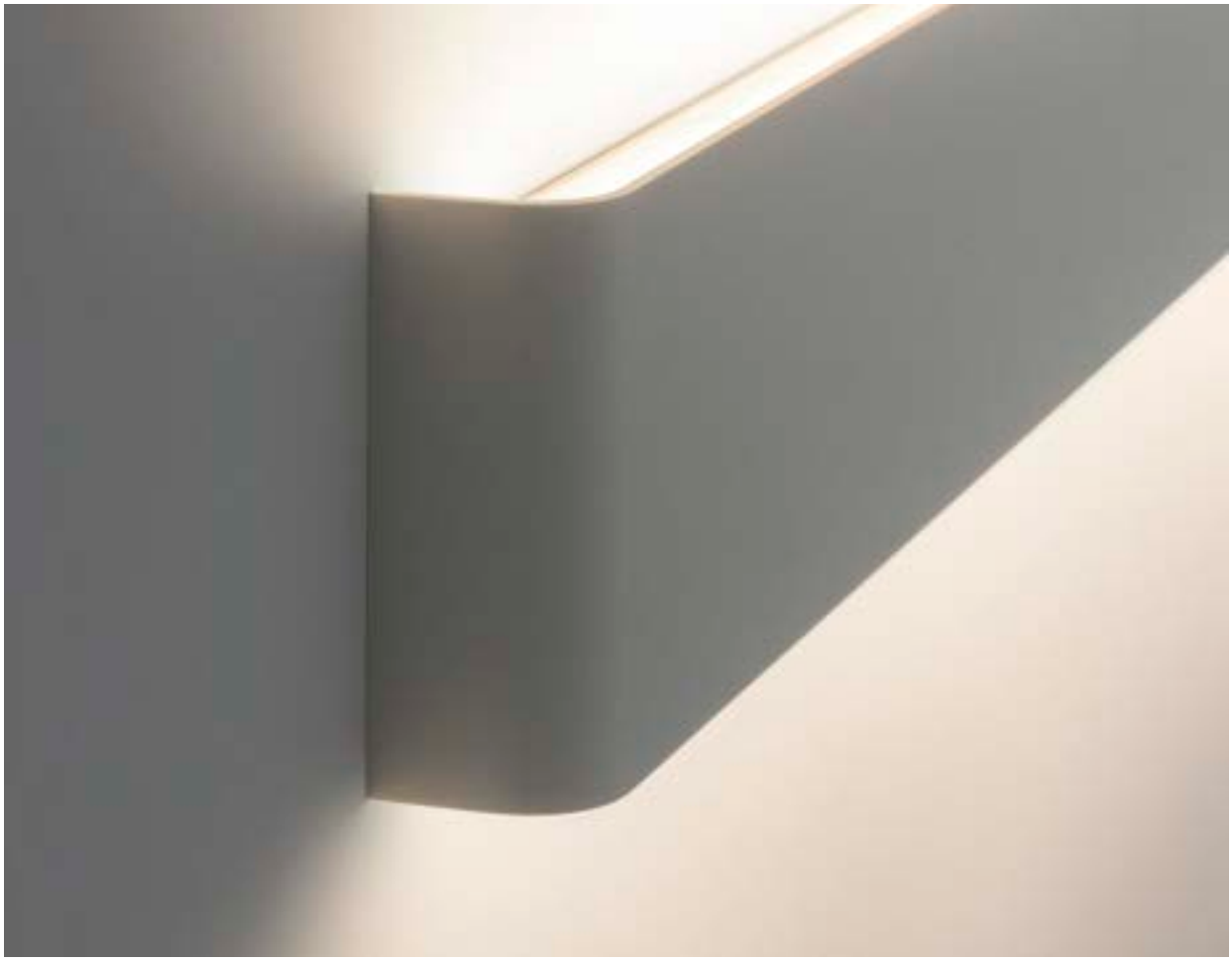
DELTA

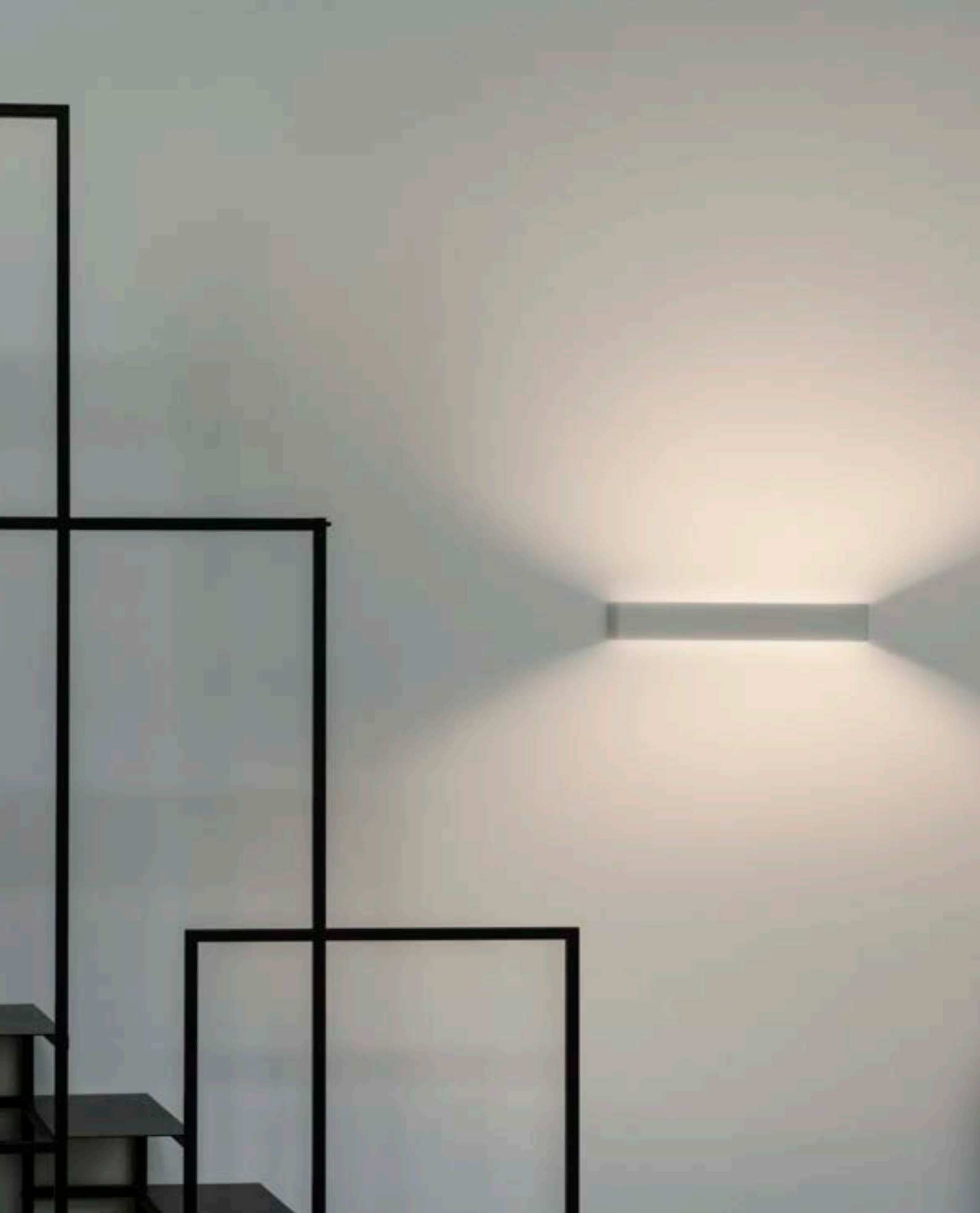
Powder-coated aluminium body.
Shiny opal color polycarbonate
diffusers. Up and down light
emission. Available finishes: white
or black.









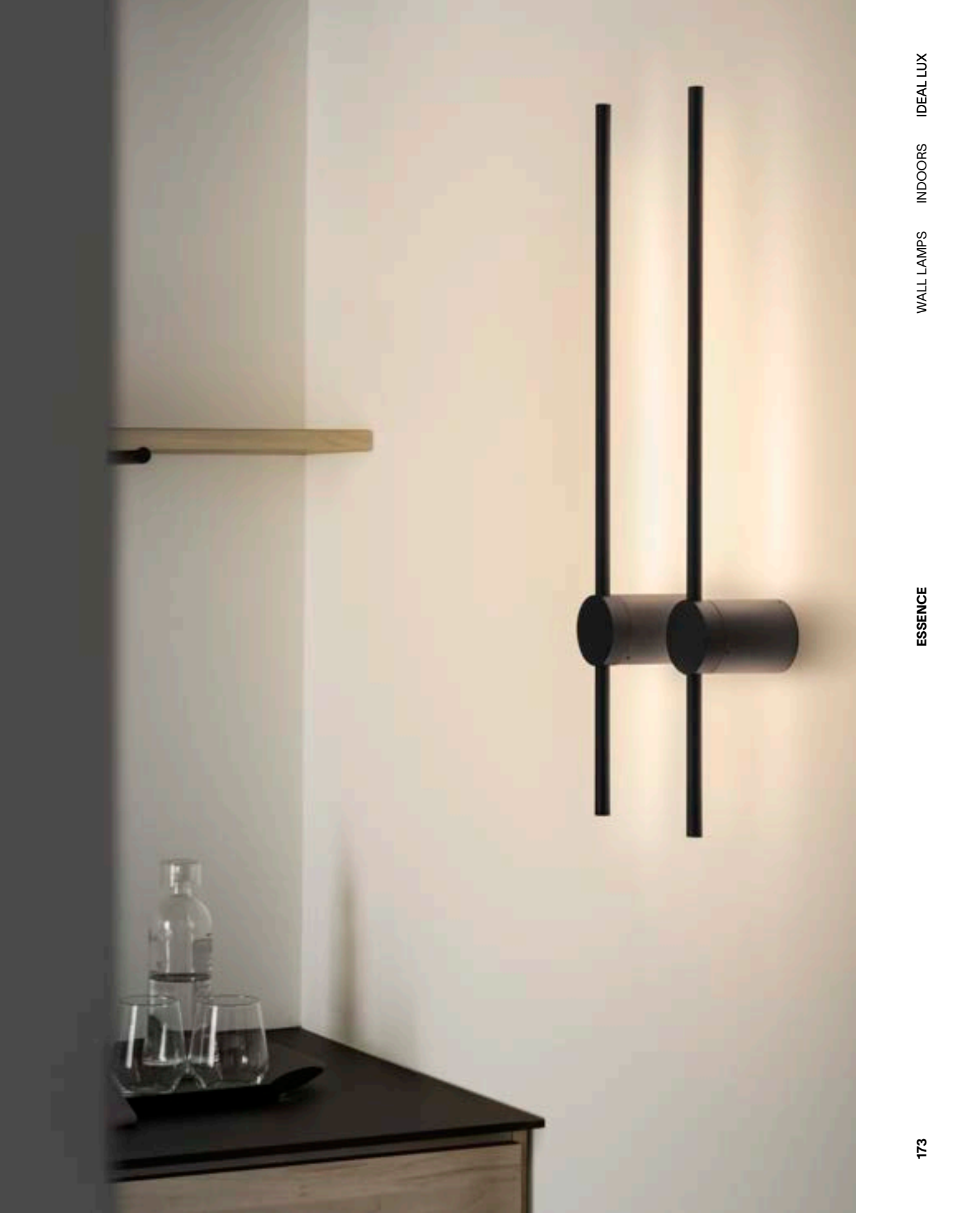






ESSENCE

Powder coated aluminum base and body. Opal color acrylic diffuser. Indirect lighting emission. Color: white or black.



WALL LAMPS INDOORS IDEAL LUX

ESSENCE









WALL LAMPS INDOORS IDEAL LUX

ESSENCE



FOCUS

Metal body with adjustable arm coated with rubber. Finished in white or black matt colour or in grey with chrome details.







WALL LAMPS INDOORS IDEAL LUX

FOCUS

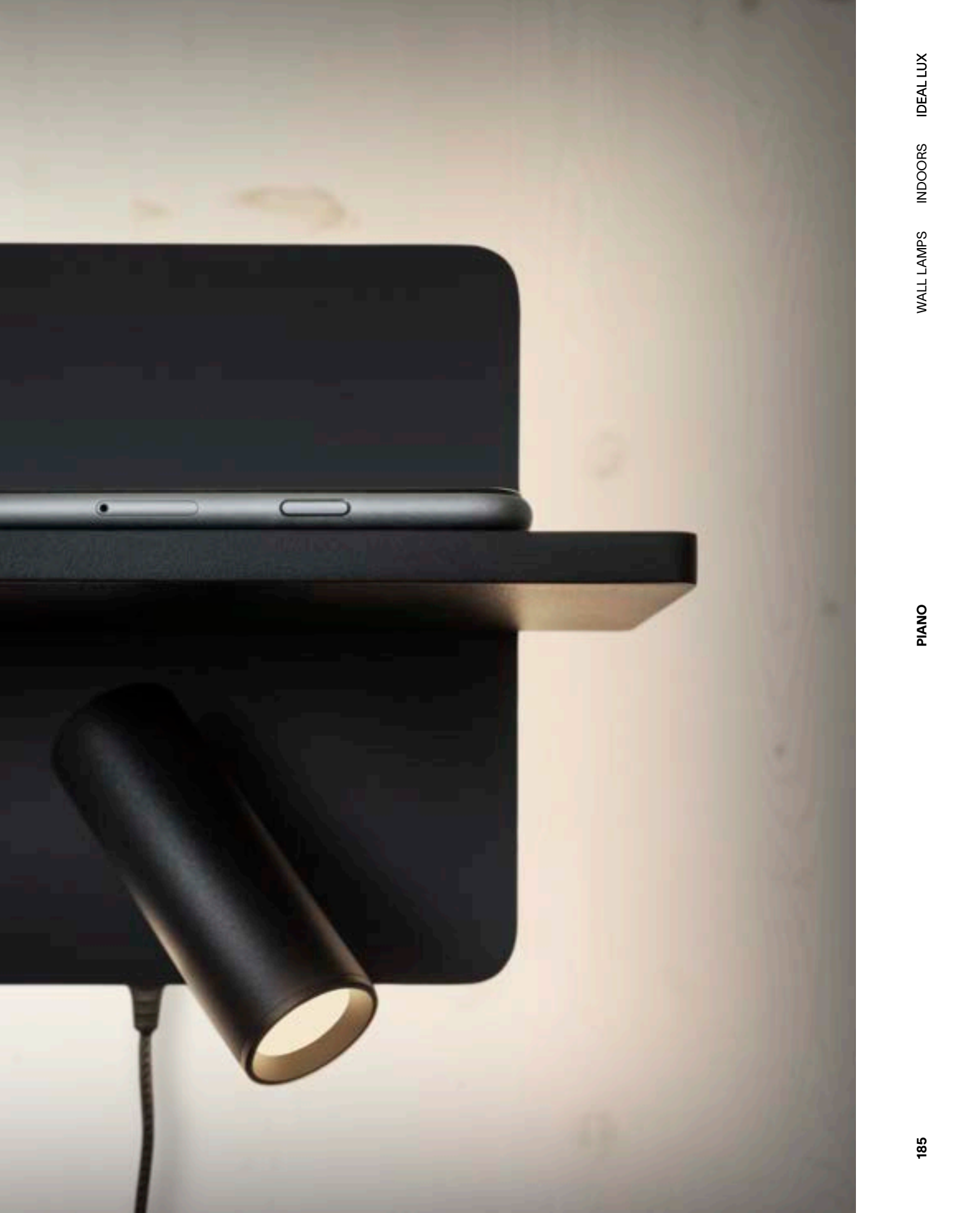


PIANO

Total powder painted aluminium frame. Opal polycarbonate diffuser with emission on the back. Adjustable frontal projector. Colours: white or black.







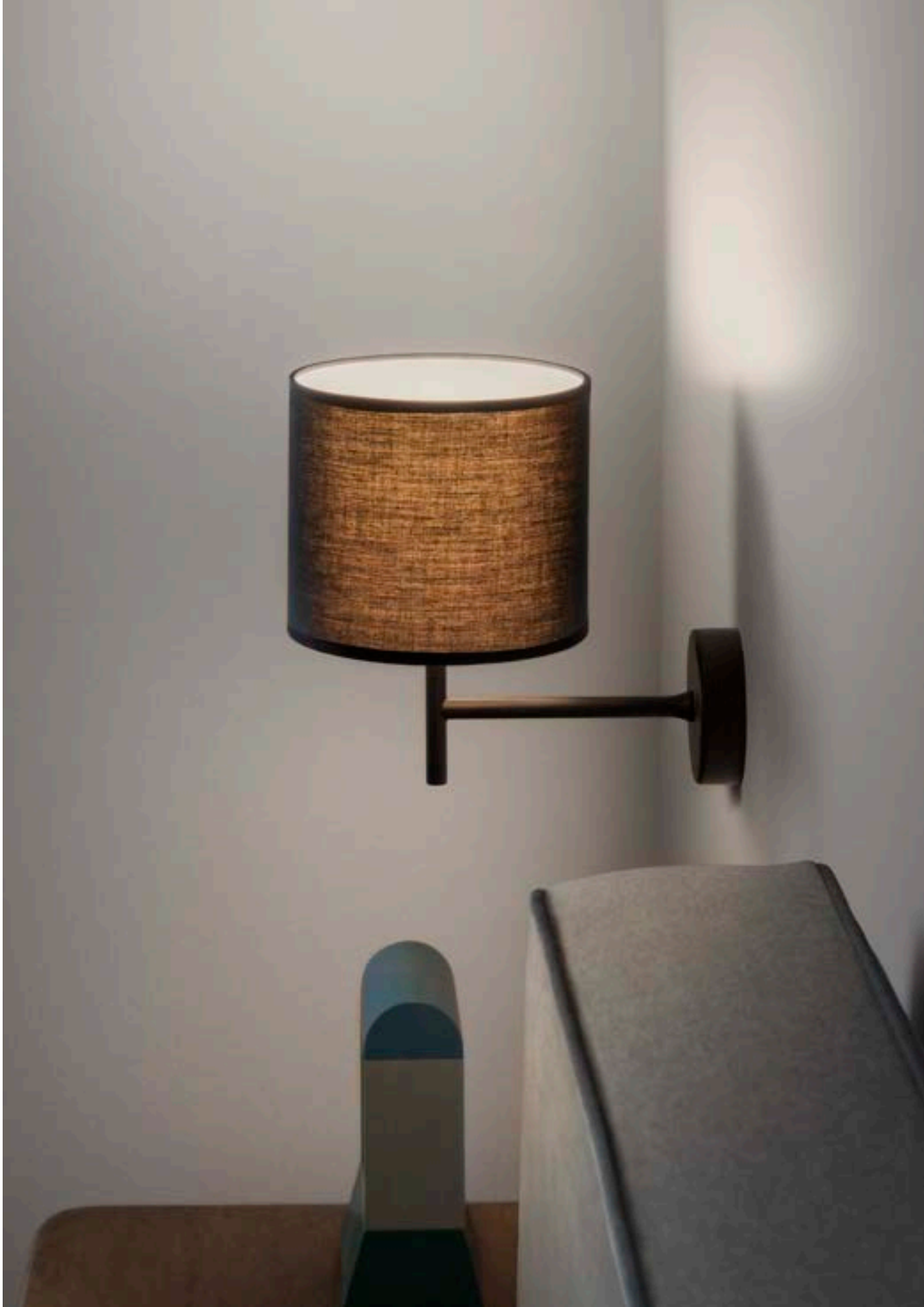


SET UP

Powder coated or plated metal frames. Two-light wall lamp with flexible rubber-coated arm, independent switches and USB socket. Lampshades in fireproof PVC covered with fabric. Frame colors: white, black, satin nickel or brushed brass with black details. Lampshade colors: beige, dove grey, white or black.







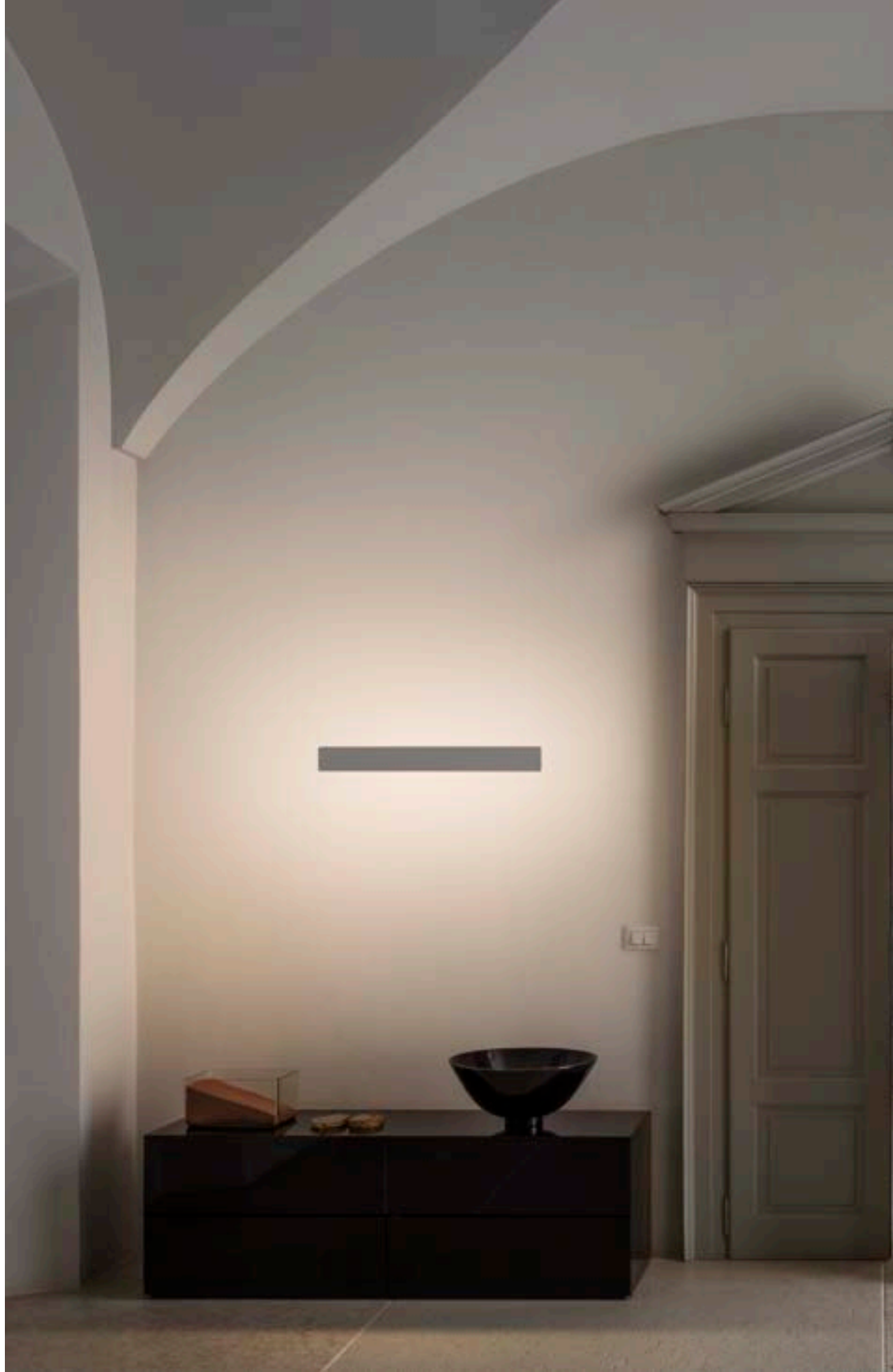




ZIG ZAG

Heat-sink body totally made of aluminium sheet of 6 mm thickness.
White or black powder paint finish or plated brass or copper.
Integrated LED source.







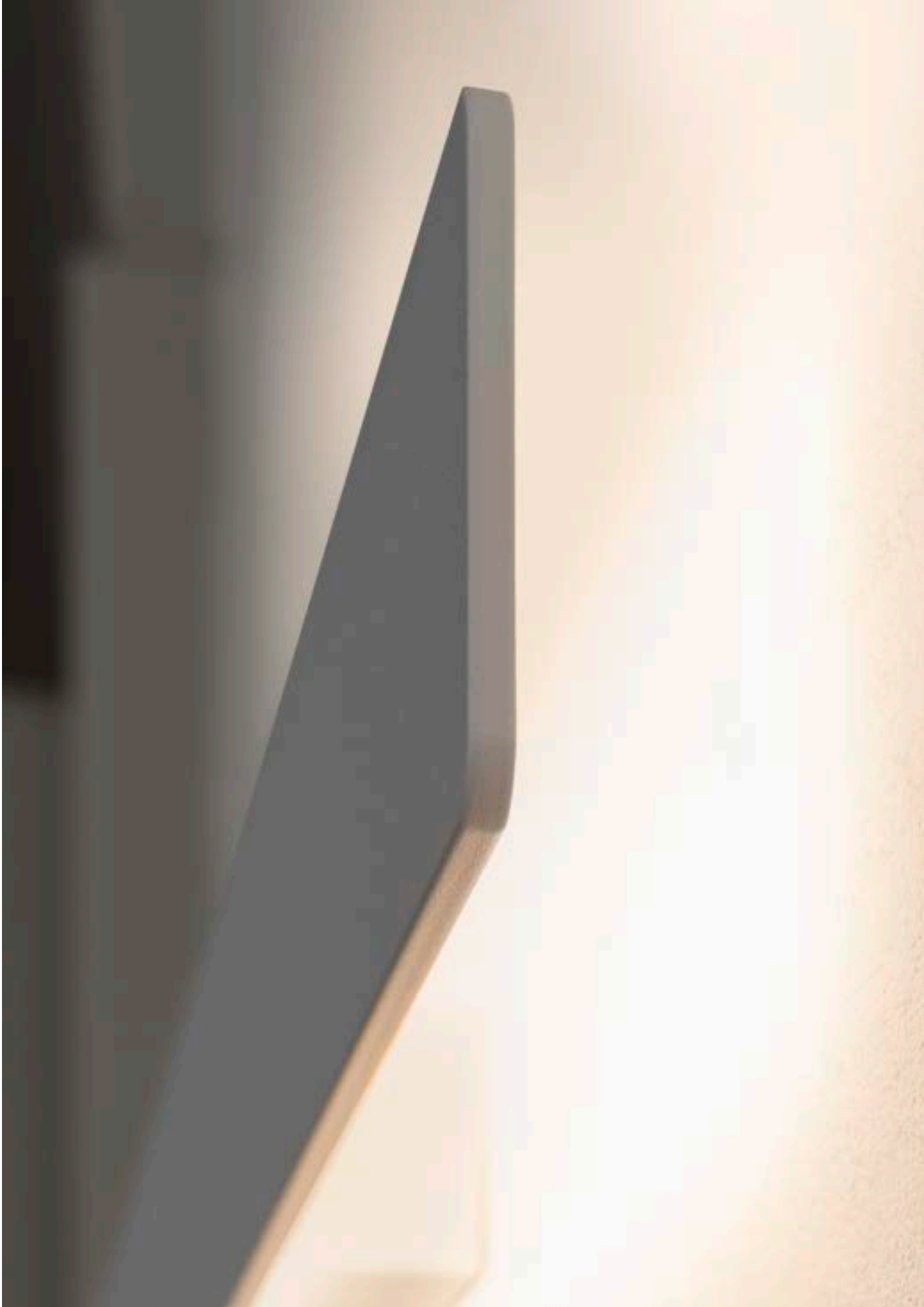
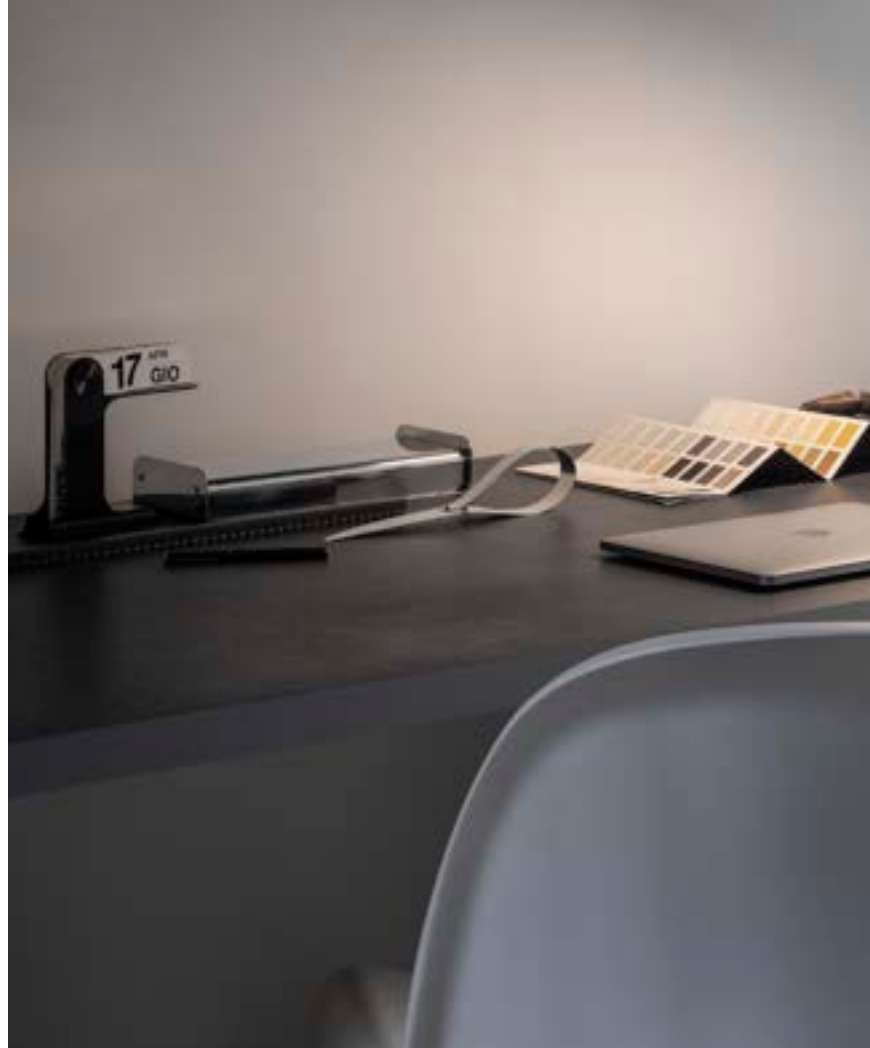




TABLE LAMPS

SCRIBBLED
NOTES,
BLOSSOMED
IDEAS,
ATTENTIVE
LIGHT,
THAT INSPIRES.
ENLIGHTENED
IDEAS,
STEADY
FOCUS.
FLUID
THOUGHTS,
DANCING.





Index



198 **Futura**
204 **Mapa Bianco**
210 **Oz**
218 **Pivot**
224 **Set Up**
230 **Yoko**

DATASHEETS ONLY
489 **Birds**
492 **Diesis**
501 **Filo**
530 **Perlage**



FUTURA

Articulated aluminum and plastic
arm with PVC exposed wire.
Adjustable LED diffuser
and integrated switcher.
Plug with power supply.













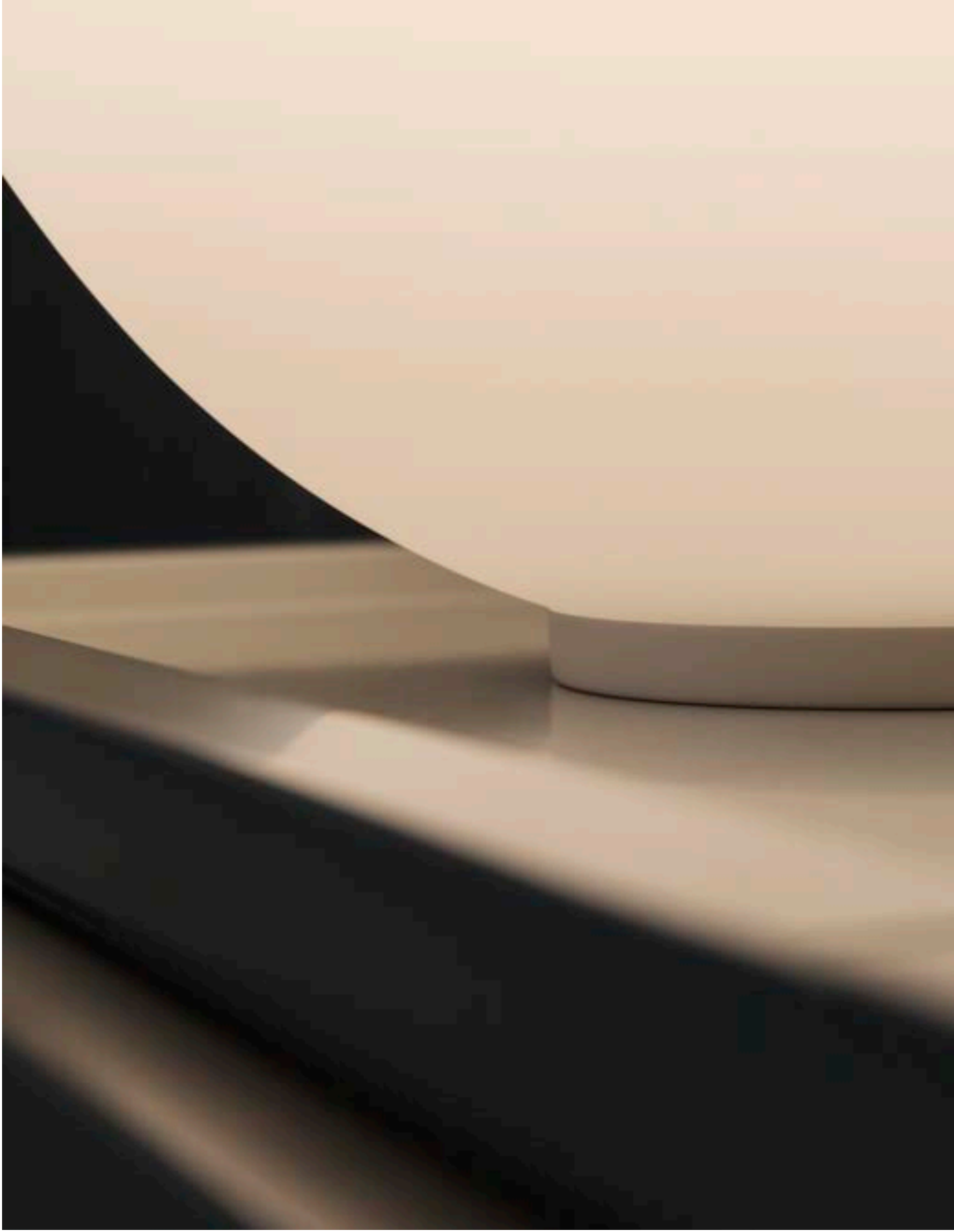
MAPA BIANCO

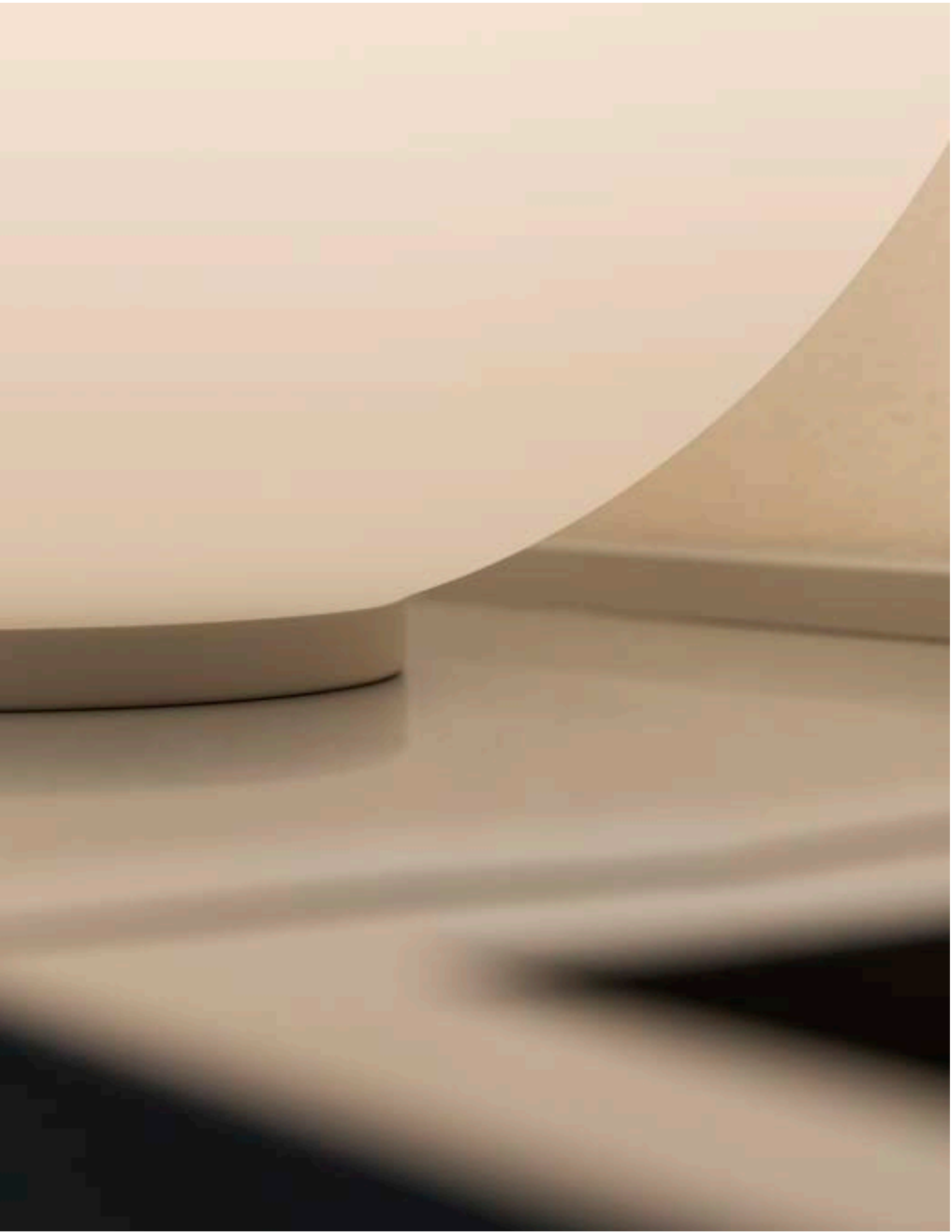
White metal base and fastening system. White blown acid-etched spherical glass diffuser.





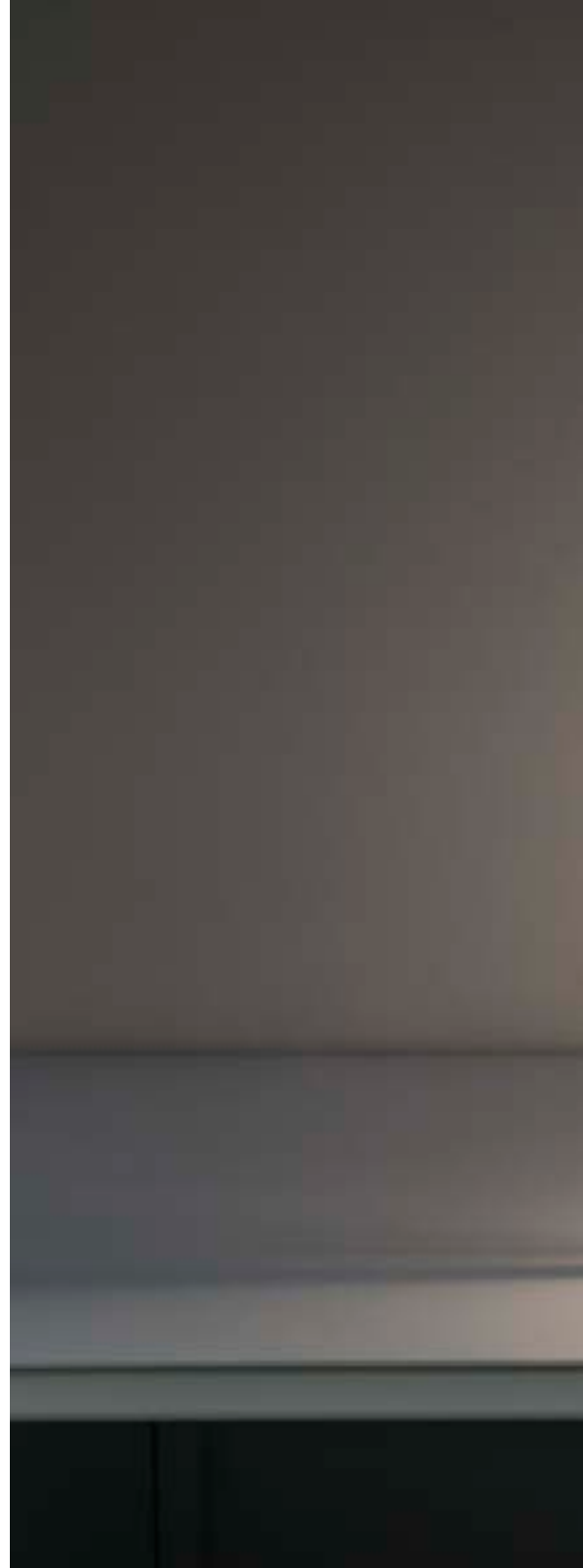






OZ

Plated or powder coated metal base and frame. PVC wires. Opal rubber diffuser. Available finishes: white, black or brushed brass.

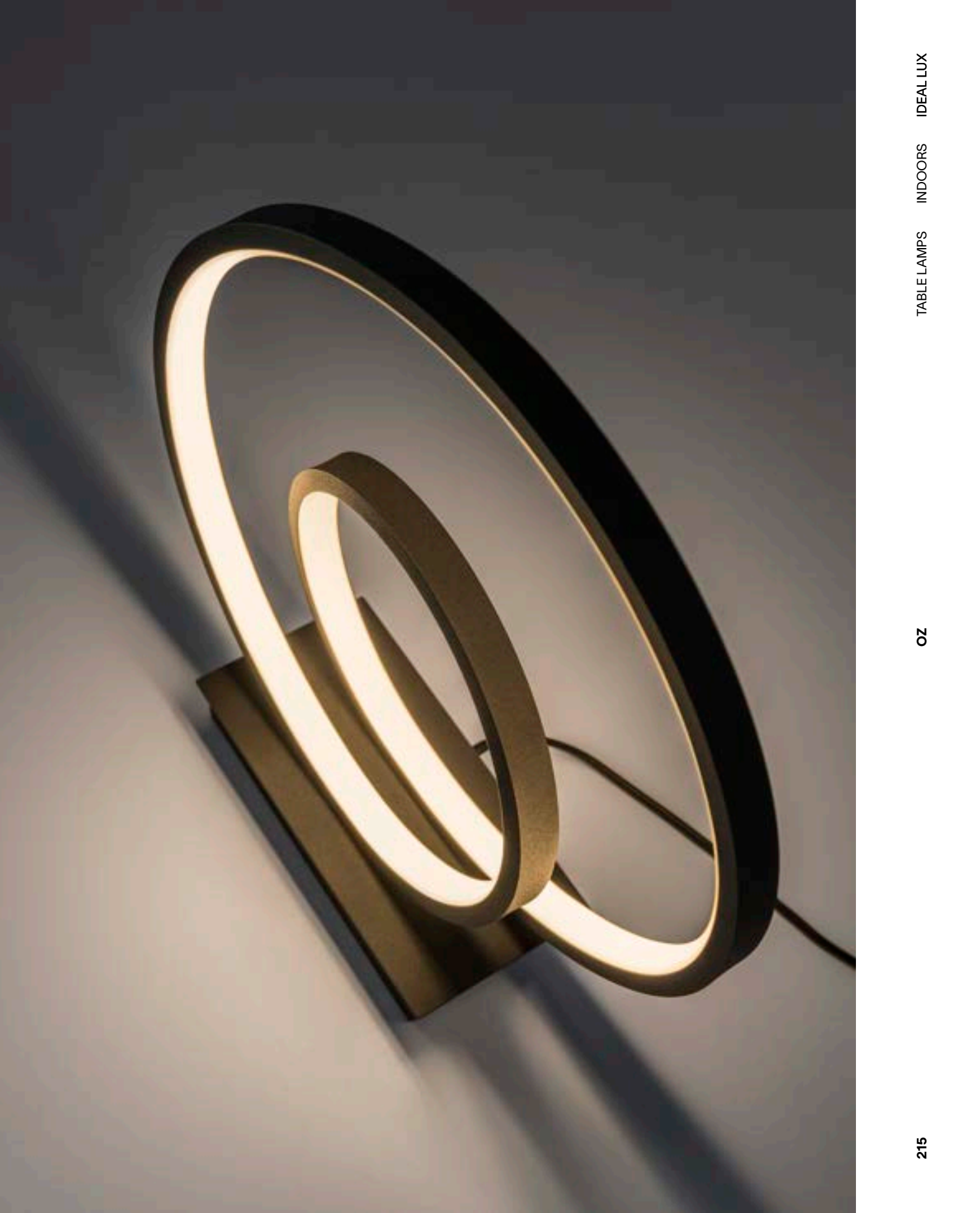


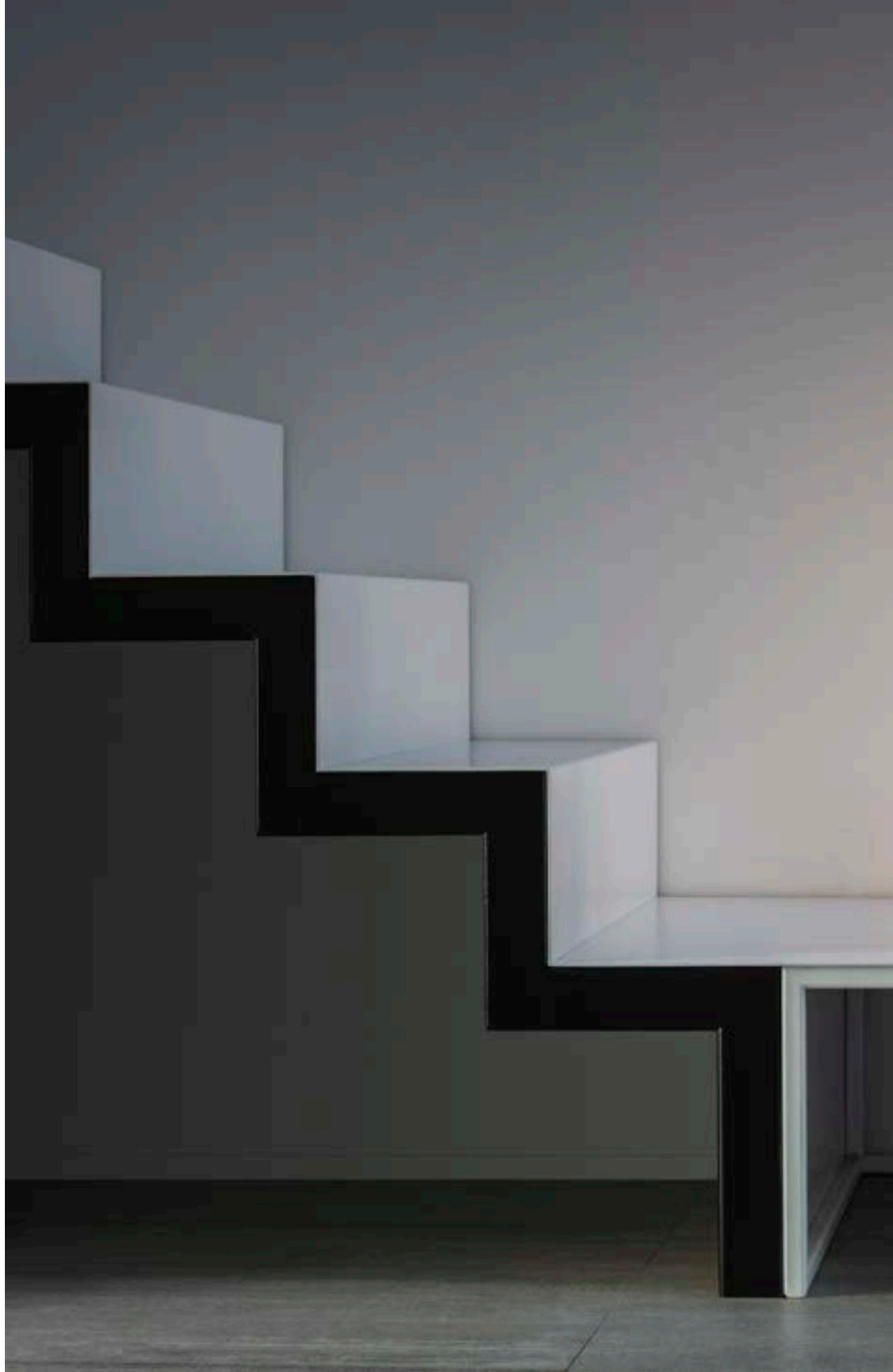












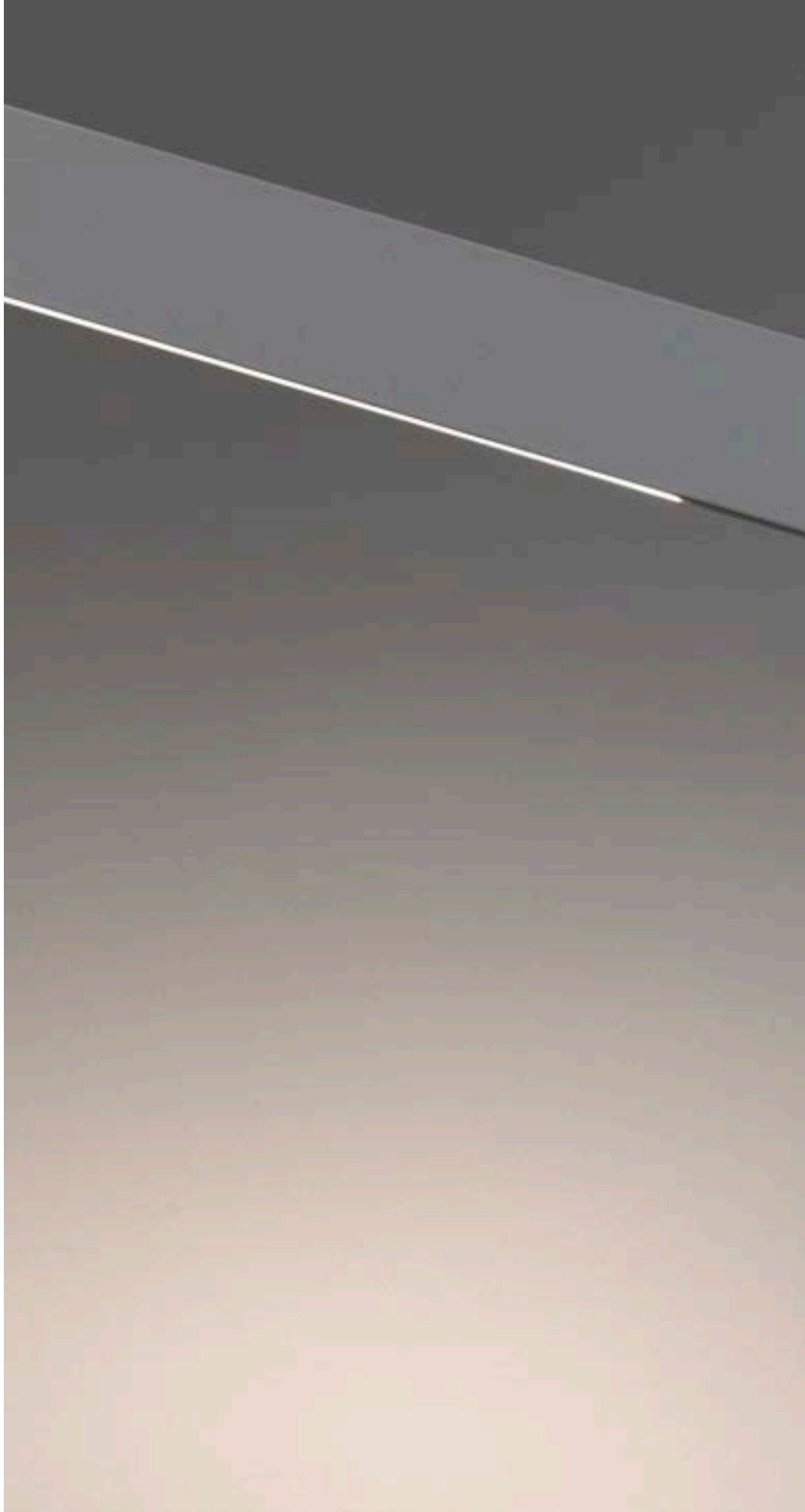


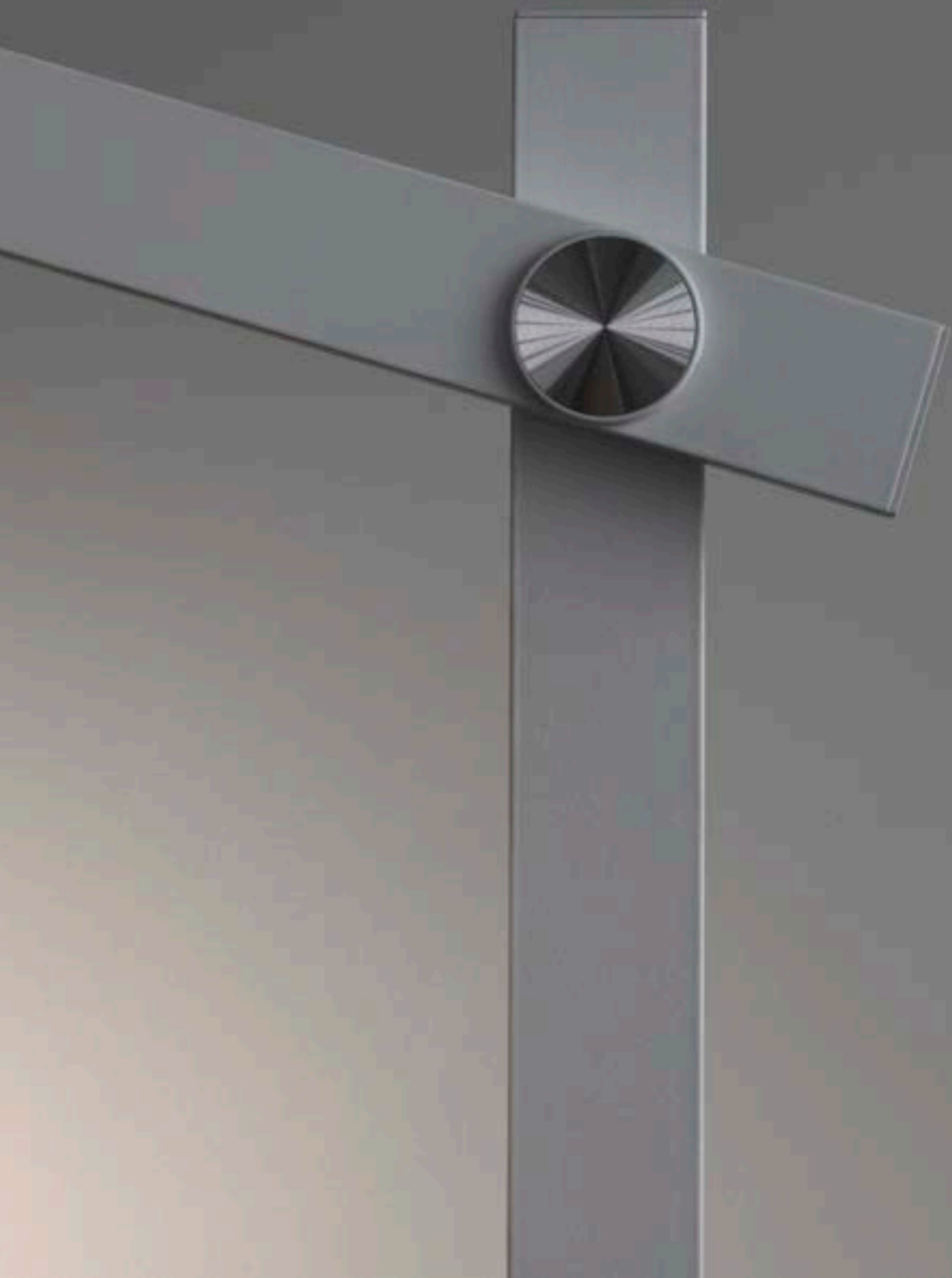


PIVOT

Matt varnished aluminium frame.
Base coated with plastic with
dimmer. Adjustable diffuser with
satin opal color PC screen.
PVC cable with driver and plug.







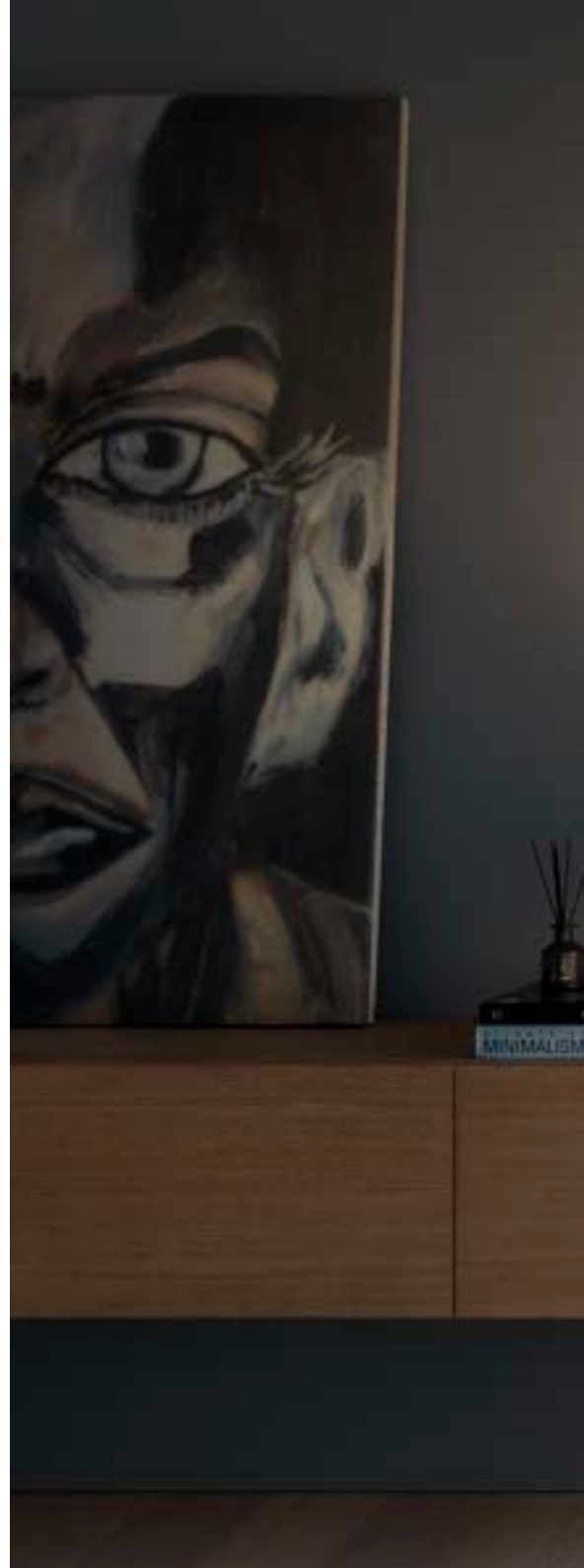




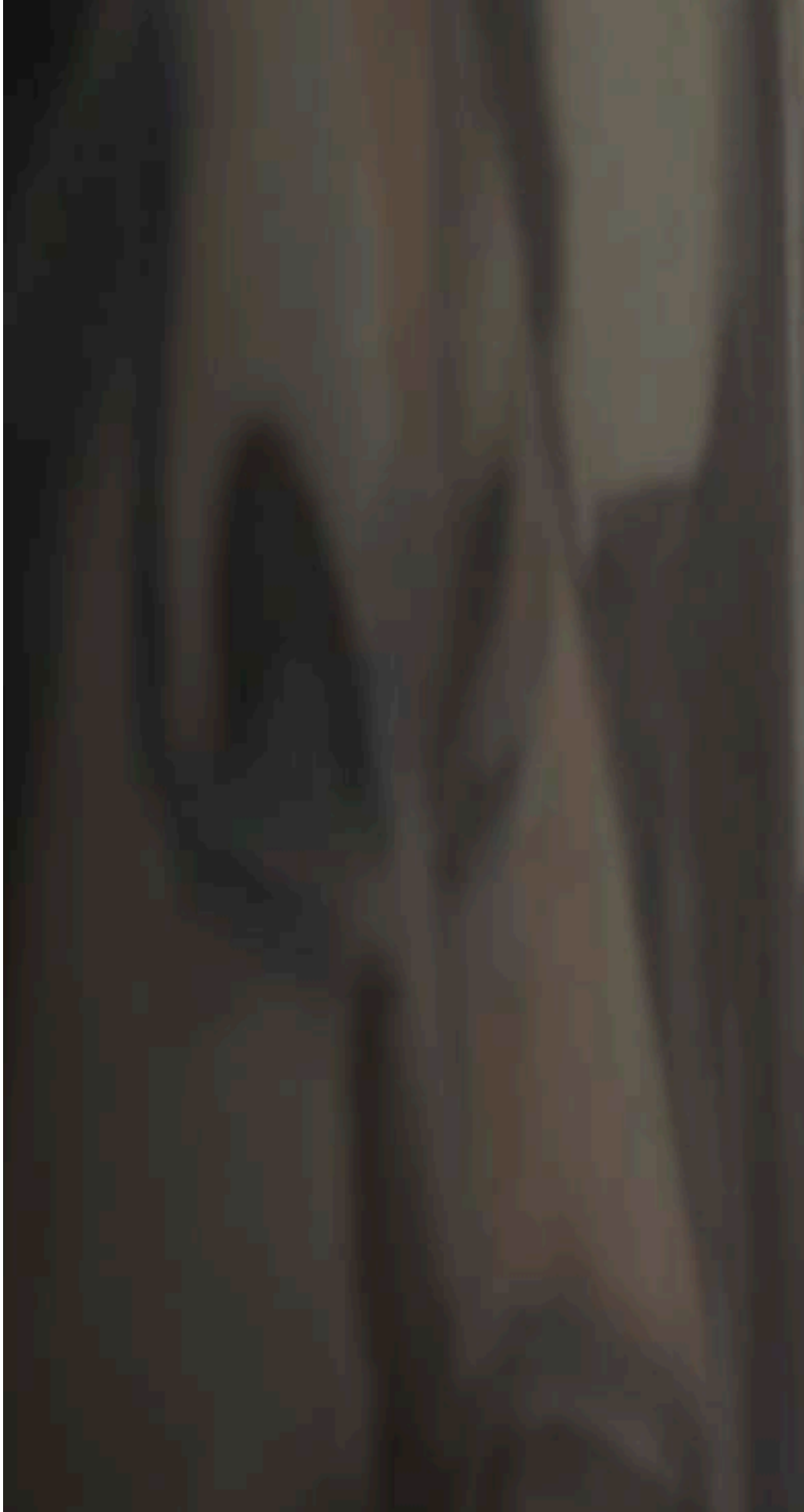


SET UP

Powder coated or plated metal frames. Lampshades in fireproof PVC covered with fabric. Frame colors: white, black, satin nickel or brushed brass. Lampshade colors: beige, dove grey, white or black.













9905



YOKO

Matt varnished metal base and frame. Opal polycarbonate diffuser. PVC electrical cable with socket-power supply. Colors: white or black.









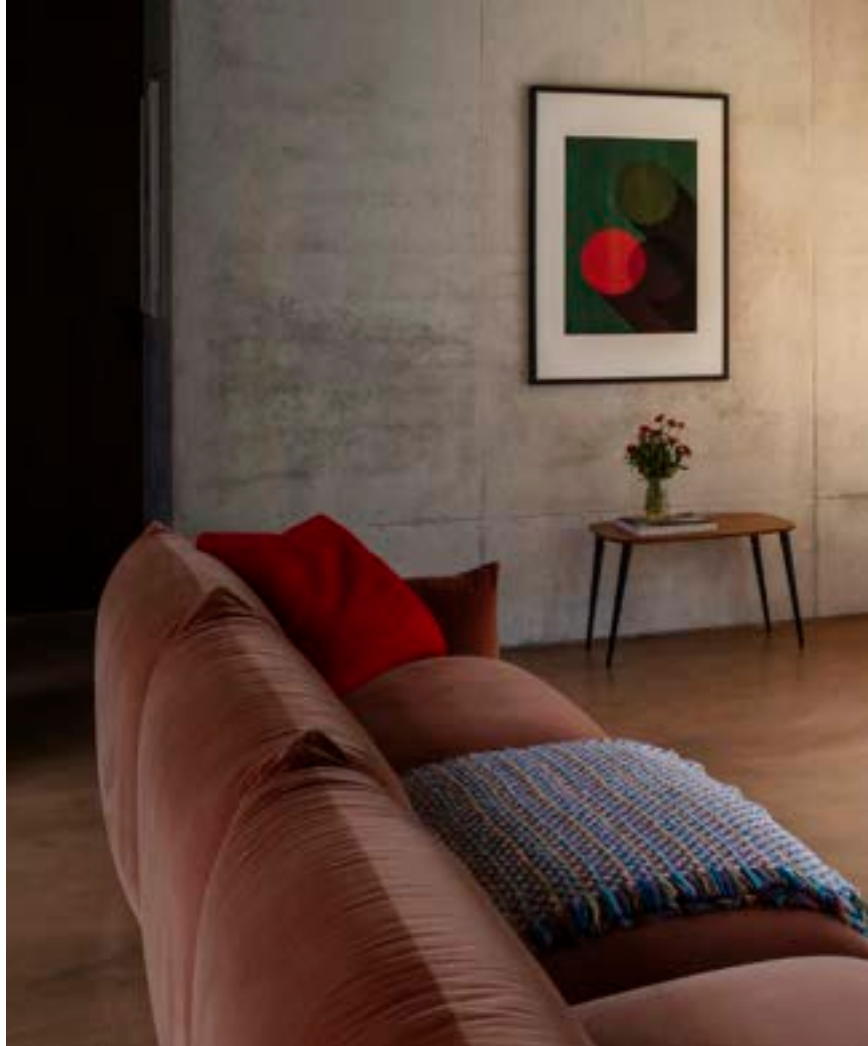




FLOOR LAMPS

STEPS
RESOUNDING,
HOME
AWAITING.
LIGHT
EMBRACING.
CALMNESS
SPREADING,
REST
BECOMING FAMILIAR,
MEMORIES
DANCING
IN THE AIR.





Index



238 **Birds**
244 **Diesis**
252 **Dorsale**
258 **Equinox**
264 **Filo**
270 **Perlage**
276 **Set Up**
280 **Yoko**

DATASHEETS ONLY

508	Frame
508	Futura
512	Look
518	Mix Up



BIRDS

Varnished metal frame with satin brass decorative disc. White acid-etched blown glass diffusers. PVC cable with switch and plug. Color: matt black with satin brass detail.













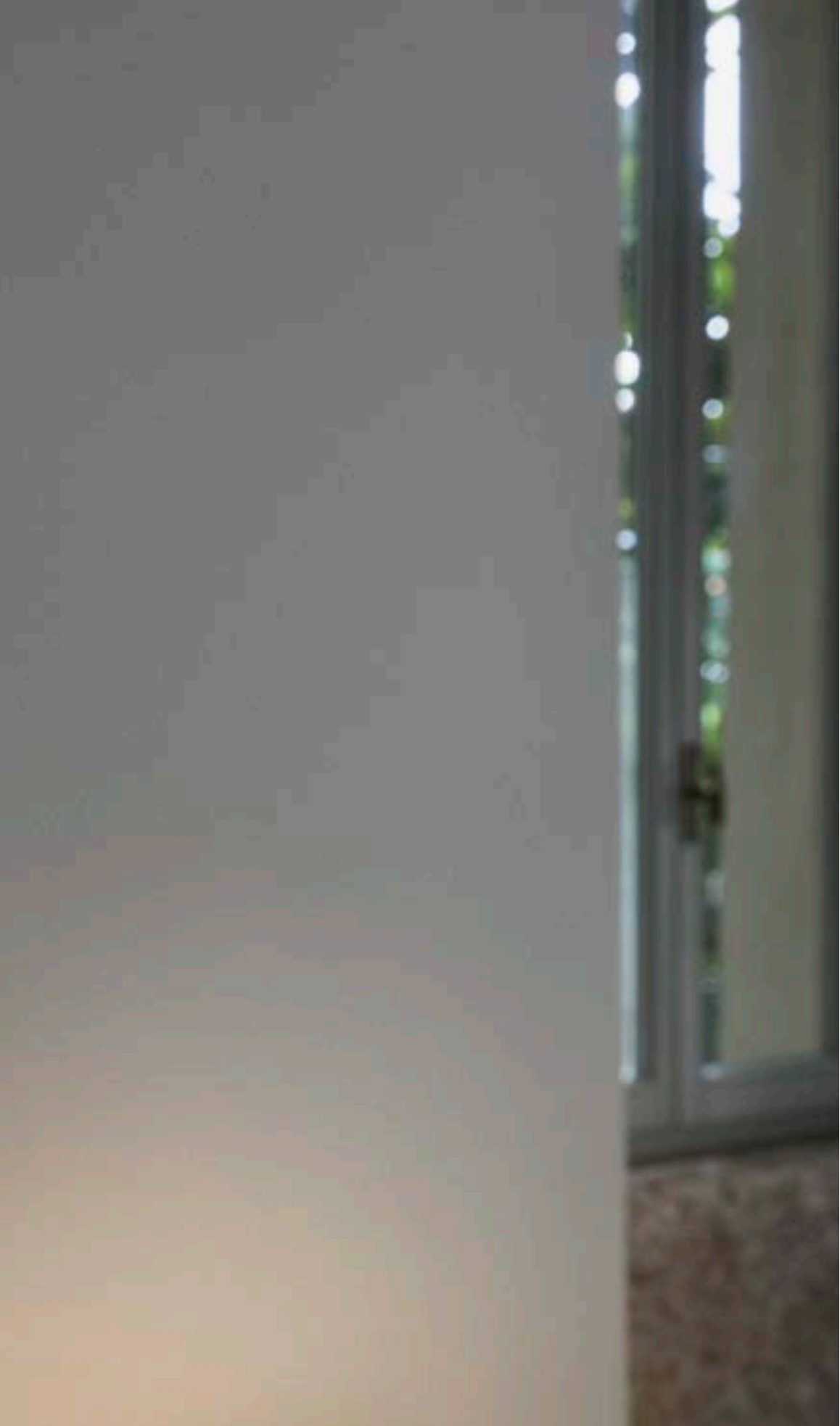


DIESIS

Powder coated or plated metal frame. Adjustable diffuser: it can be rotated or inclined. PVC cable with switch. Color: black, satin nickel or satin brass.

















DORSALE

Metal frame with chrome or white or black matt varnish finish.
The arm is composed of three elements with square section.
PVC foil shade, available in chrome or coated with white or black fabric.















EQUINOXE

Metal frame and electrified arms with chrome or antiqued brass finish. Transparent blown glass diffusers.











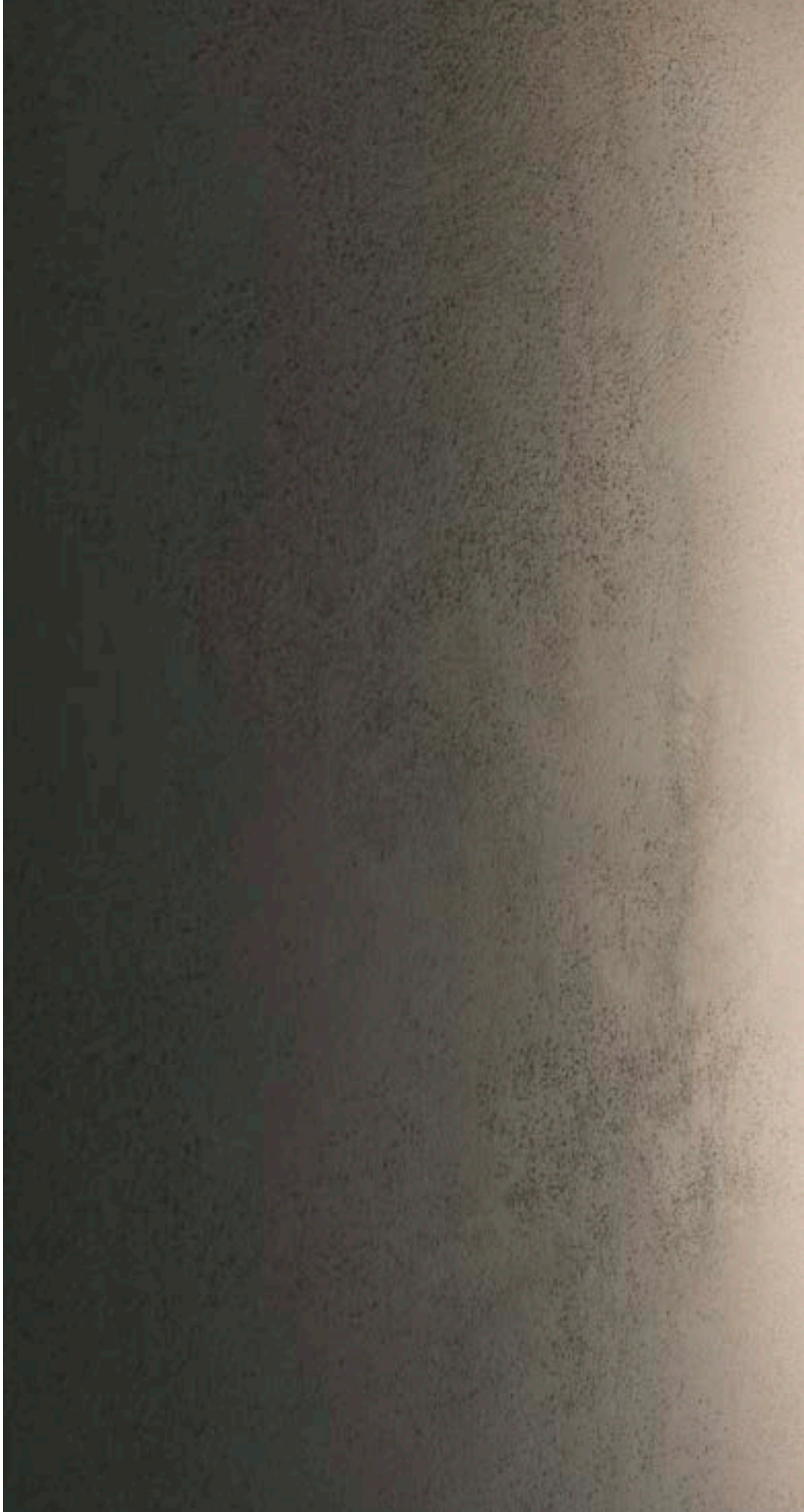




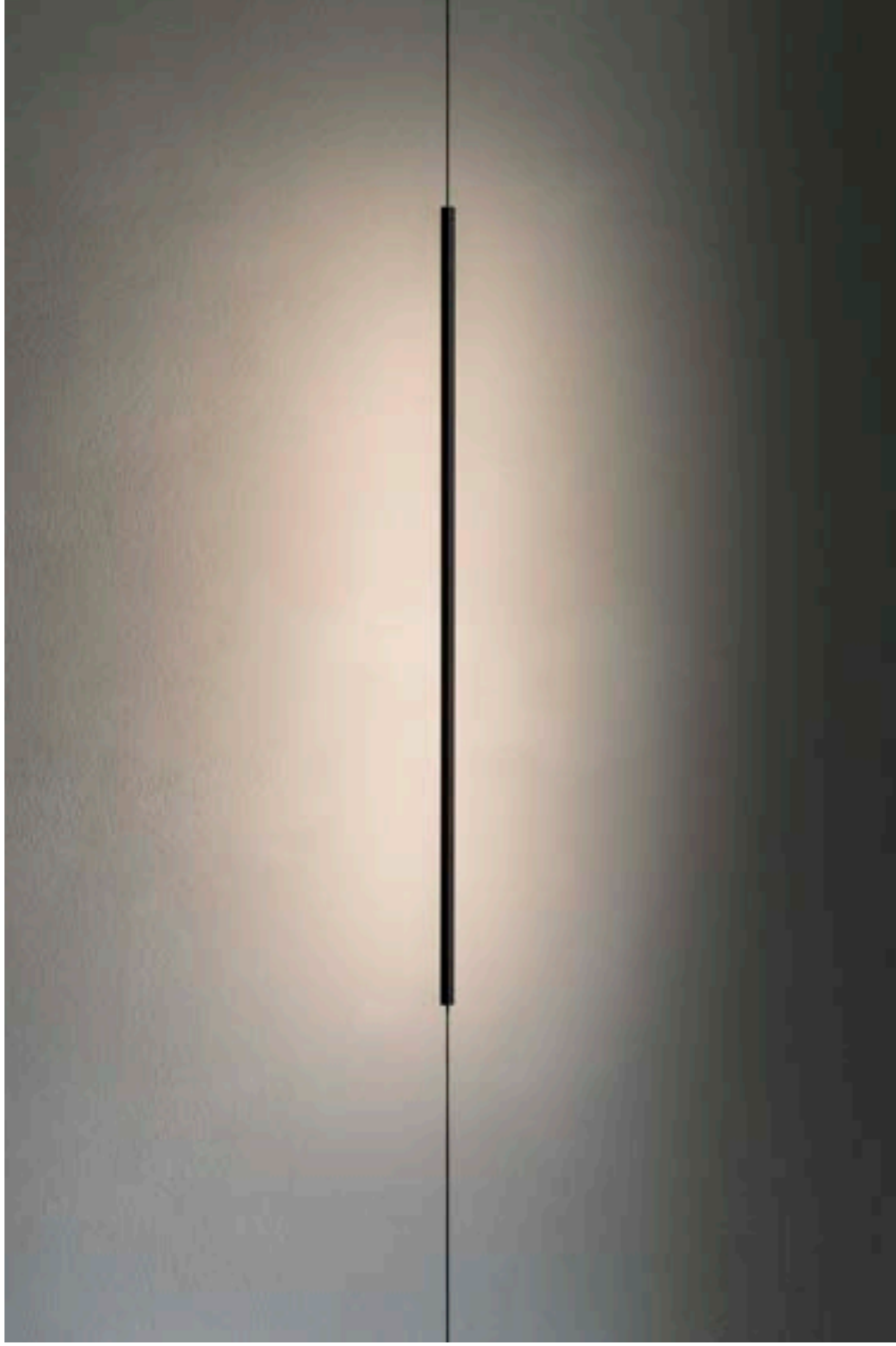
FILO

Plated or powder-coated metal ceiling cap, body and floor base.
Satin opal color PVC diffuser.
Black PVC supporting cable.
Powered from base by a black PVC cable with plug. Available finishes: white, black or brass.













PERLAGE

Metal frame. Blown glass diffusers.
Finishes: Matt black with amber or
smoky Pyrex glasses or satin brass
with etched white glasses.













SET UP

Powder coated or plated metal frames. Lampshades in fireproof PVC covered with fabric.
Frame colors: white, black, satin nickel or brushed brass.
Lampshade colors: beige, dove grey, white or black.





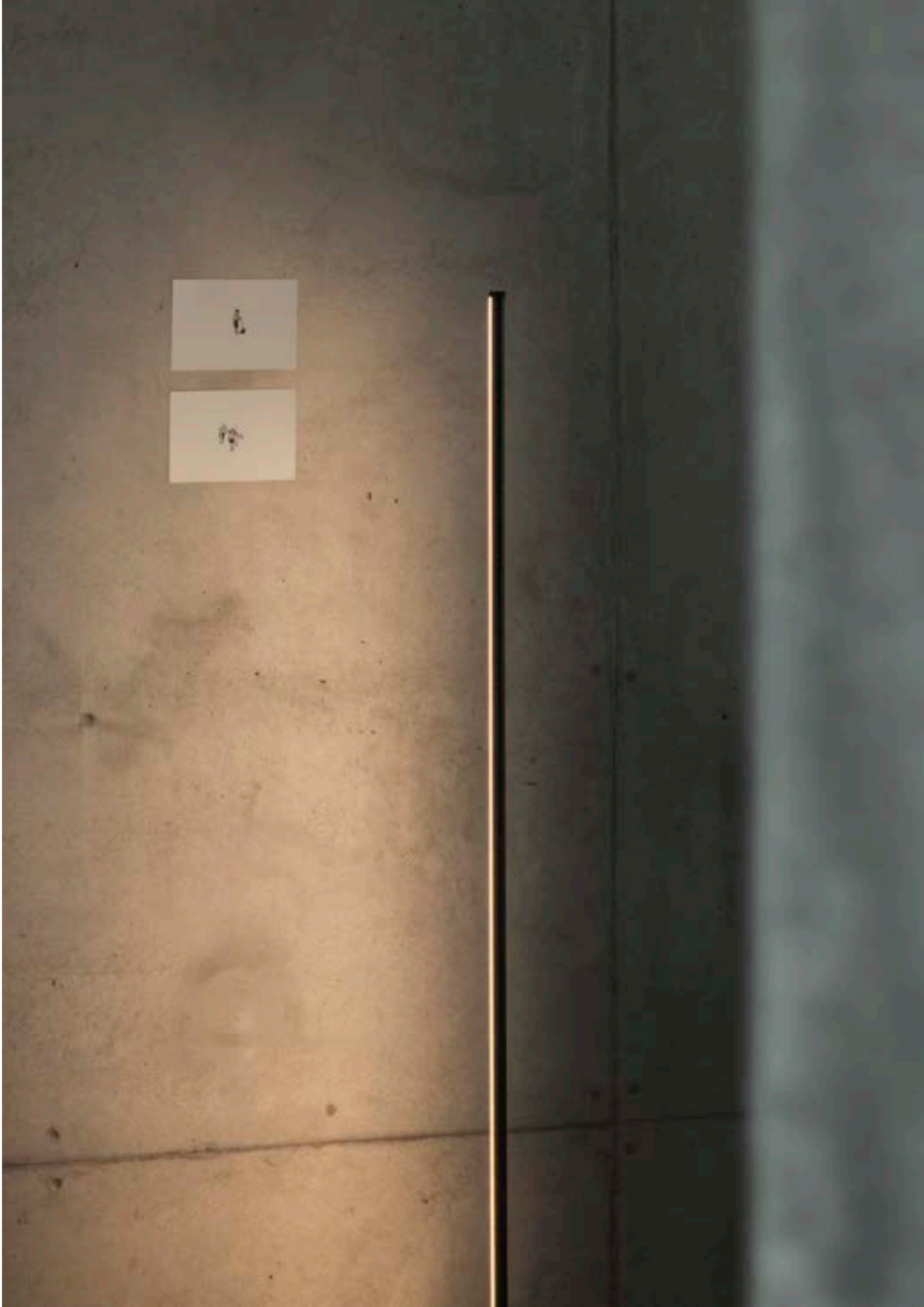




YOKO

Matt varnished metal base and frame. Opal polycarbonate diffuser. PVC electrical cable with socket-power supply. Colors: white or black.











SYSTEMS, SPOTLIGHTS AND TRACKS

OPEN BOOK,
LIGHT
THAT SETS,
PAGES
FLYING,
WORDS
EXPANDING,
OUTLINES
BEING DRAWN,
EYES THAT
SETTLE,
MIND THAT
OPENS,
SOUL THAT
FREES.





Index



288 **Display**
296 **Ego**
316 **Eos**
324 **Fluo**
330 **Fox**
334 **Linus**
340 **Quick**
346 **Tesi**

DATASHEETS ONLY
580 **Link**
513 **Look**



DISPLAY

Aluminum linear projector suitable for installation on three-phase track (Eutrac standard), available in three different lengths and with powder coating with white or black finish. The integrated power driver is located inside the track to minimize the volume of the visible product.



















EGO

Linear system composed of an extruded aluminum profile and magnetically fastened lighting elements with mechanical safety lock. The system is available in matt black RAL 9005, matt white RAL 9016 or anodized satin brass, in the ceiling or suspension installation mode (LOW and HIGH), recessed without edge that disappears into the plasterboard (RECESSED), rapid recessed into the plasterboard (RECESSED EASY) or recessed with edges for plasterboard or paneled false ceilings (RECESSED TRIM).

Possibility of composition with different light modules depending on the desired arrangement, modifiable if necessary.

Ideal for lighting small and large environments where ample flexibility and high quality lighting is required, for example museums, commercial, residential and retail spaces.





EGO
index



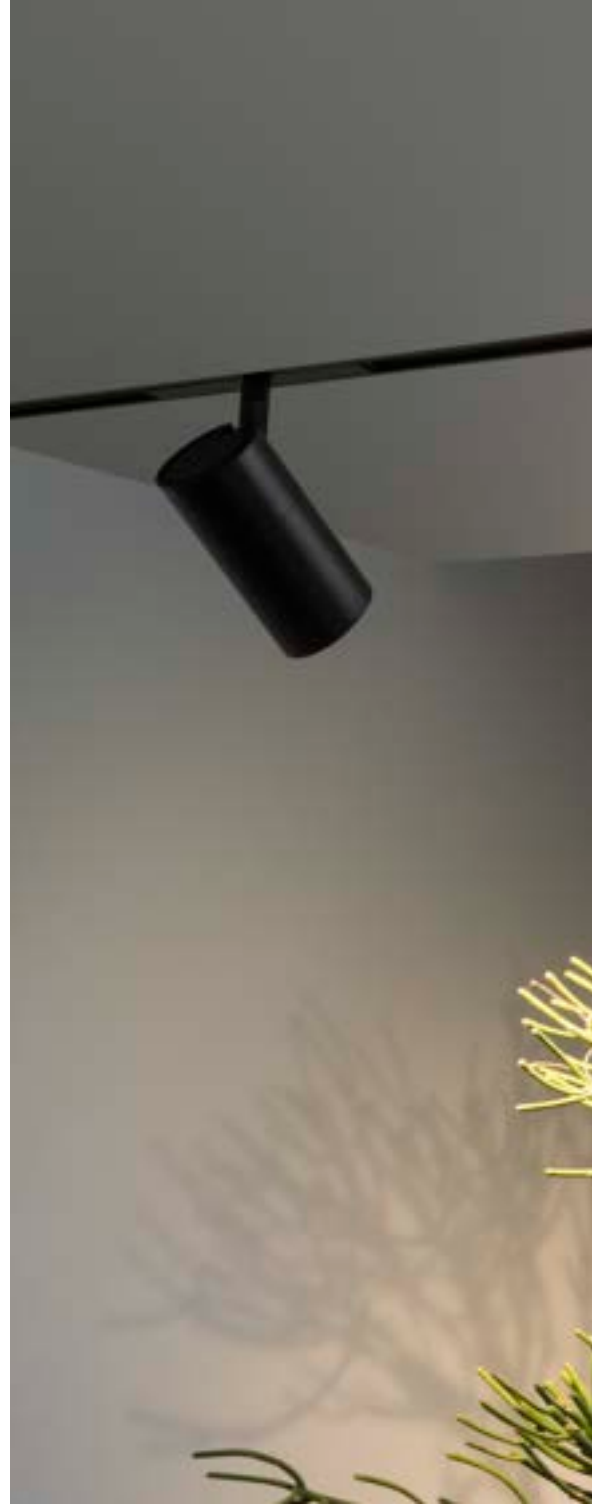
549 **Accent**
545 **Track Single**
548 **Track Flat**
550 **Wide**

DATASHEETS ONLY

564 Drivers
551 Flexible
556 High
554 Low
553 Pendant
558 Recessed
548 Track Big
547 Track Double



EGO Track Single

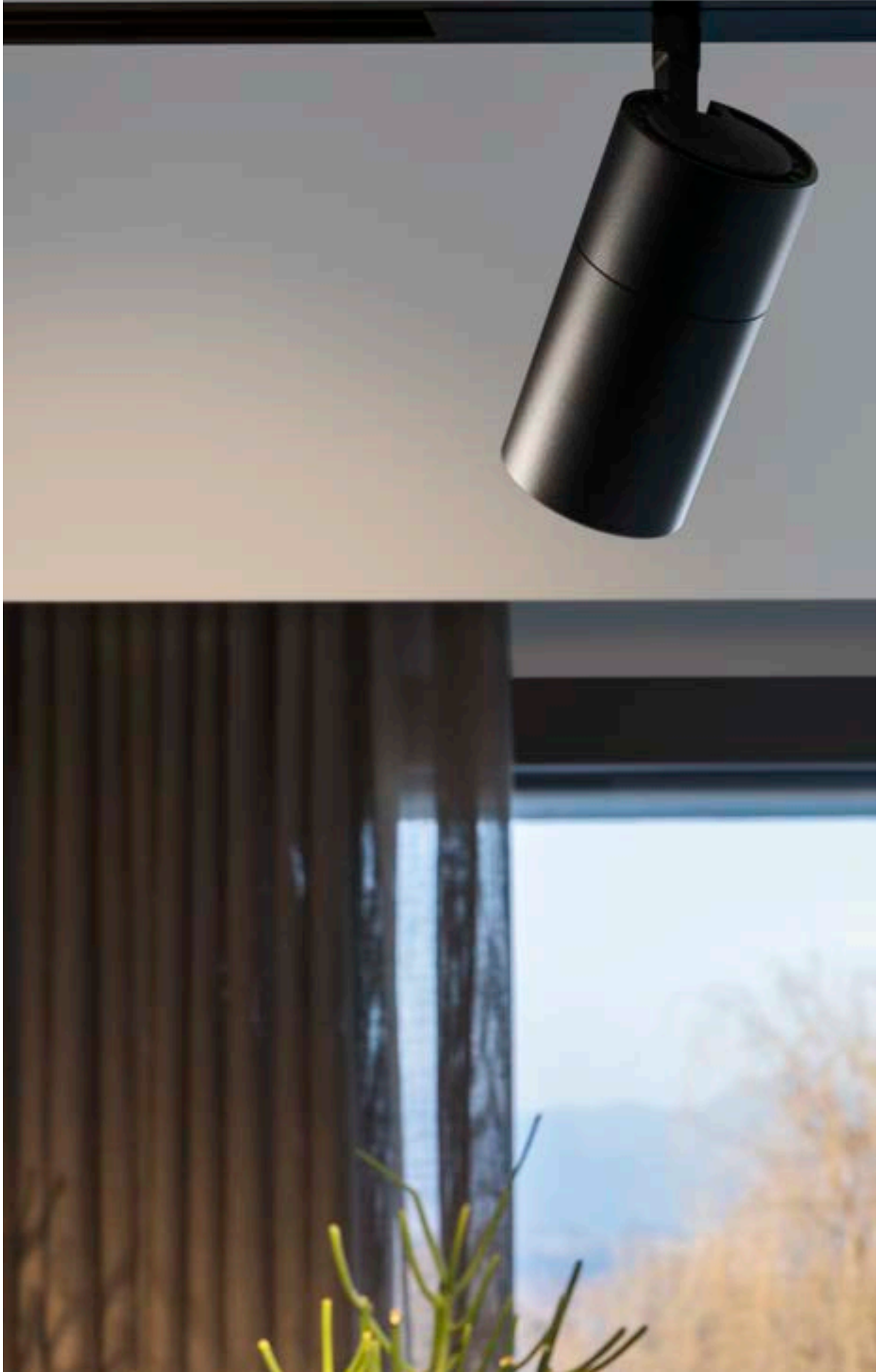


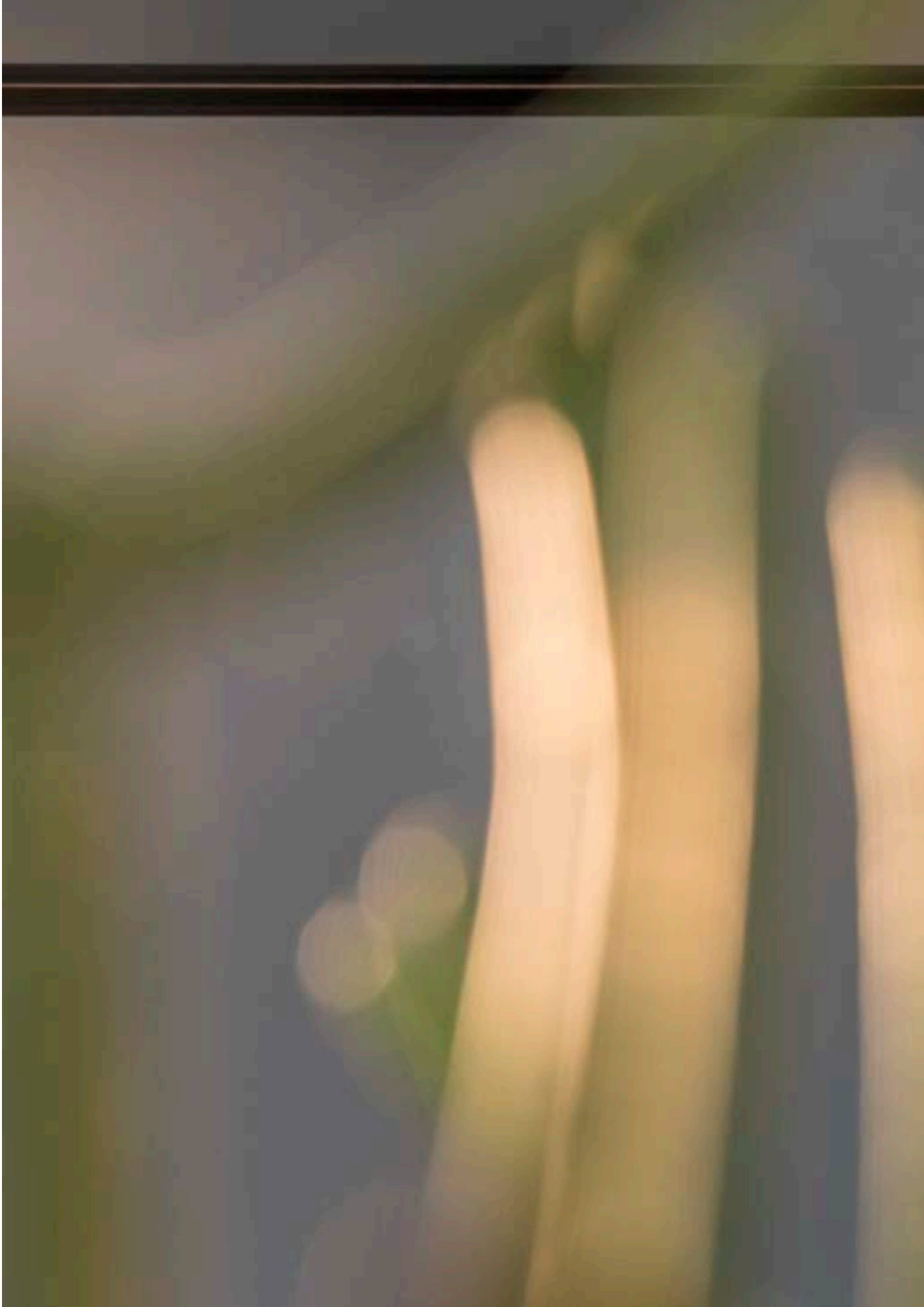












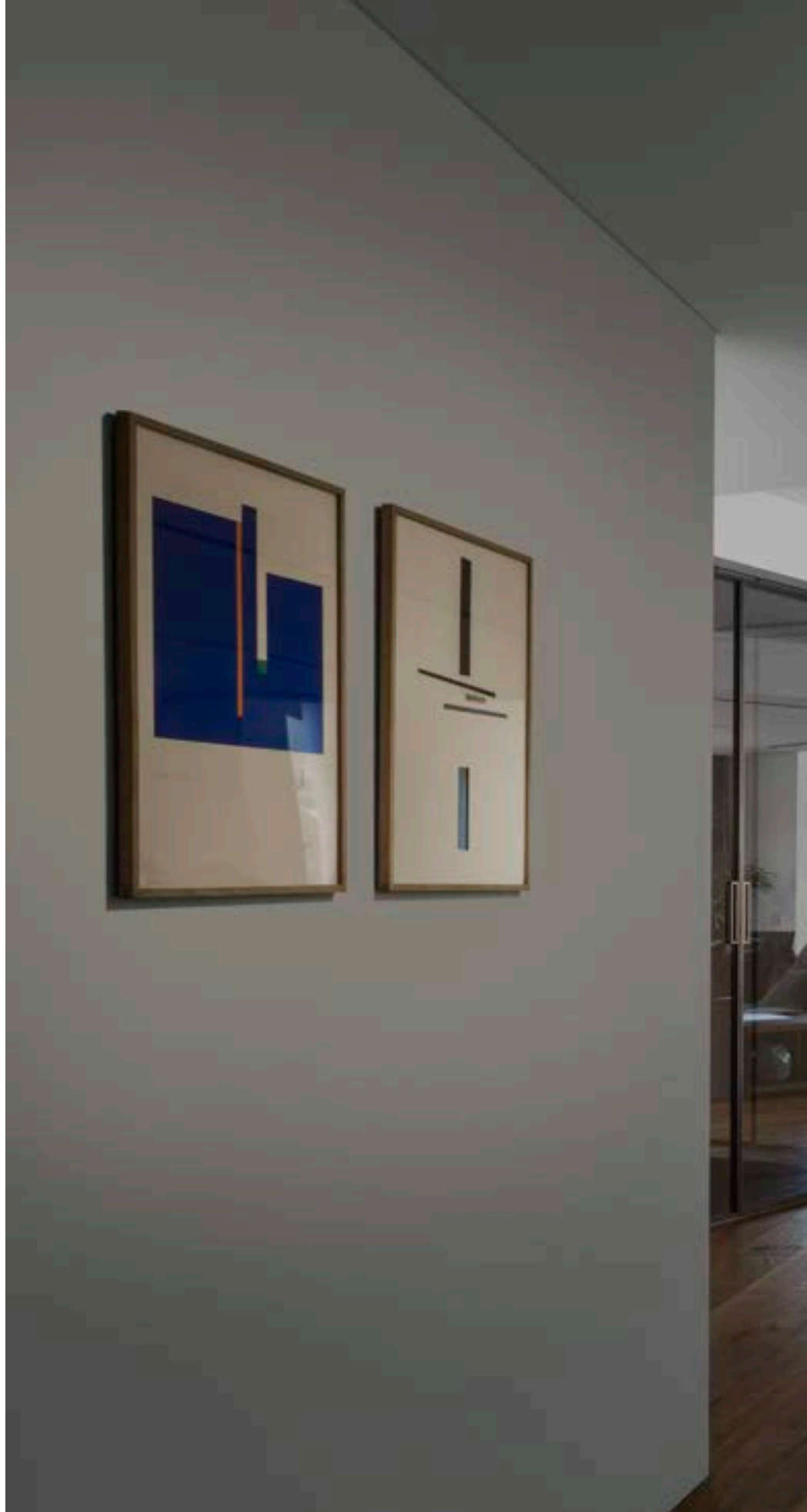




EGO Track Flat











EGO Wide













EOS

Extruded aluminum cylindrical tracklight with symmetric optic and variable opening beam from narrow to wide (20°-55°), suitable for three-phase track installation. White or black powder coating, 355° turning head and 90° adjustable, the power driver is included and located in the cylindrical body of the projector itself. Ideal for installation in big rooms, where great flexibility and high color rendering is required, such as museum, commercial and retail spaces.

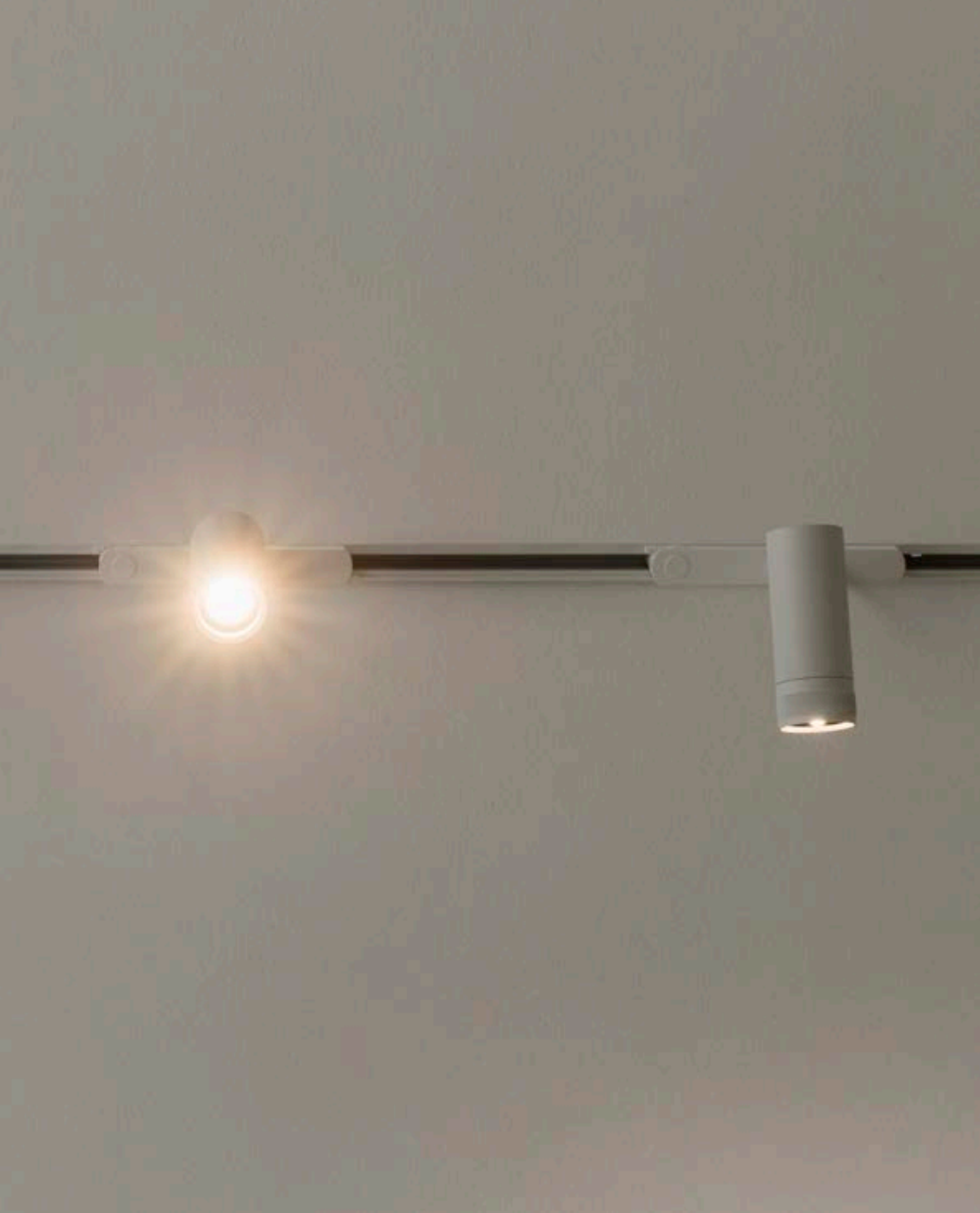


















FLUO

Linear system of lamps with extruded aluminum, 50 mm wide and 80 mm high body. Modules available in two lengths: 1200 mm and 1800 mm, which can be assembled according to the desired arrangement. The system is available in three different arrangements: the WIDE diffusing module, the BI-EMISSION module with component for indirect lighting and the ACCENT module with glare control.













FOX

Cylindrical aluminum projector suitable for installation on three-phase track. White, black or satin brass powder coating, 350° rotating head and 90° adjustable, the power driver is included and is located in the cylindrical body of the projector itself. 1-10 V or DALI dimmable versions available. Perfect for lighting the small and medium size environments that require wide flexibility for arrangement, where great flexibility and color rendering is required, such as commercial and retail spaces, and an optimal performance-price ratio.









LINUS

Linear aluminum lamp with direct and indirect light for wall installation. The lamp is modular and can be used individually or in a continuous line. White or black finish available.















QUICK

Extruded aluminum cylindrical tracklight suitable for installation on three-phase track. White or black powder coating, 355° turning head and 90° adjustable, the power driver is included and located in the cylindrical body of the projector itself. Ideal for installation in big rooms, where great flexibility and color rendering is required, such as museum, commercial and retail spaces.









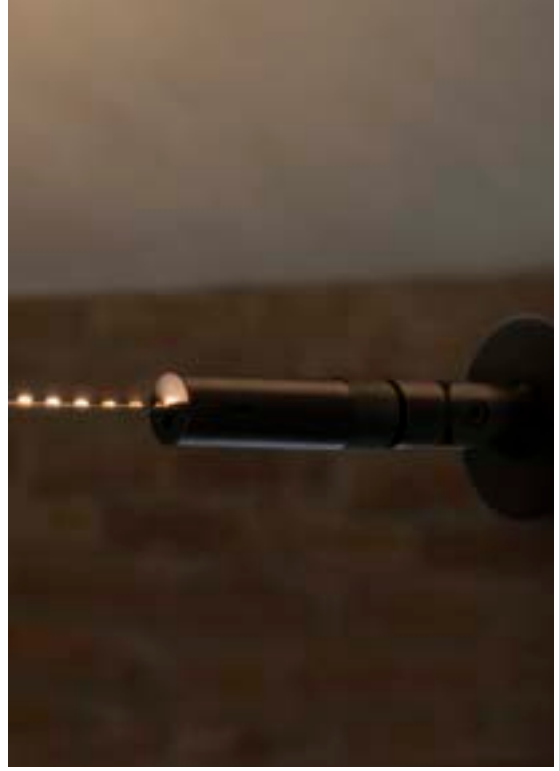




TESI

Flexible steel tape for wall-to-wall application, used as a support for the strip led application, it can be a light source for indirect lighting. 5 or 10 meters maximum length and its minimal section disappears inside the environment.

This guarantees a result of extreme formal elegance. Available finishes: steel, white or black. Ideal for environments of historical and architectural feature which already have strong personality.







TESI

SYSTEMS, SPOTLIGHTS AND TRACKS

INDOORS

IDEAL LUX





RECESSED LIGHTS

DRAWN CURTAINS,
LAMPS
THAT DIM,
CRISP
MORNING,
PEACEFUL
GARDEN.
WAKING UP
IN HARMONY,
MIST THAT
DISSIPATES,
QUIETNESS
THAT EMBRACES,
IN THE DAWN
THAT SETTLES.





Index

↳

352 **Bento**
358 **Game**
364 **Lika**
368 **Nova**
374 **Virus**



BENTO

Modular system of recessed elements consisting of an adjustable source, reflector and ring, with optional shielding lenses and accessories; black and white finish; recessed ring available in single round or square shape, or rectangular in double or triple version for the installation of multiple and independent sources; optional anti-glare band for backward movement of the source in non-adjustable mode; selection of three different emission angles.













GAME

Recessed spotlight in die-cast aluminum with round or square ring, suitable for installation on plasterboard or paneled ceilings. Chrome, matt white RAL 9001, matt black RAL 9011, matt gold RAL 1032 finishes. Available versions: with external frame (TRIM), retractable without frame for plasterboard (TRIMLESS), or with frame and improved front protection (IP65).















LIKA

Rectangular LED recessed projector in die-cast aluminum painted black or white, with shiny black polycarbonate reflector. Available in TRIM and SLIM versions with frame for installation on panels or ceilings, or TRIMLESS with hidden recessed edge for installation on plasterboard ceilings.









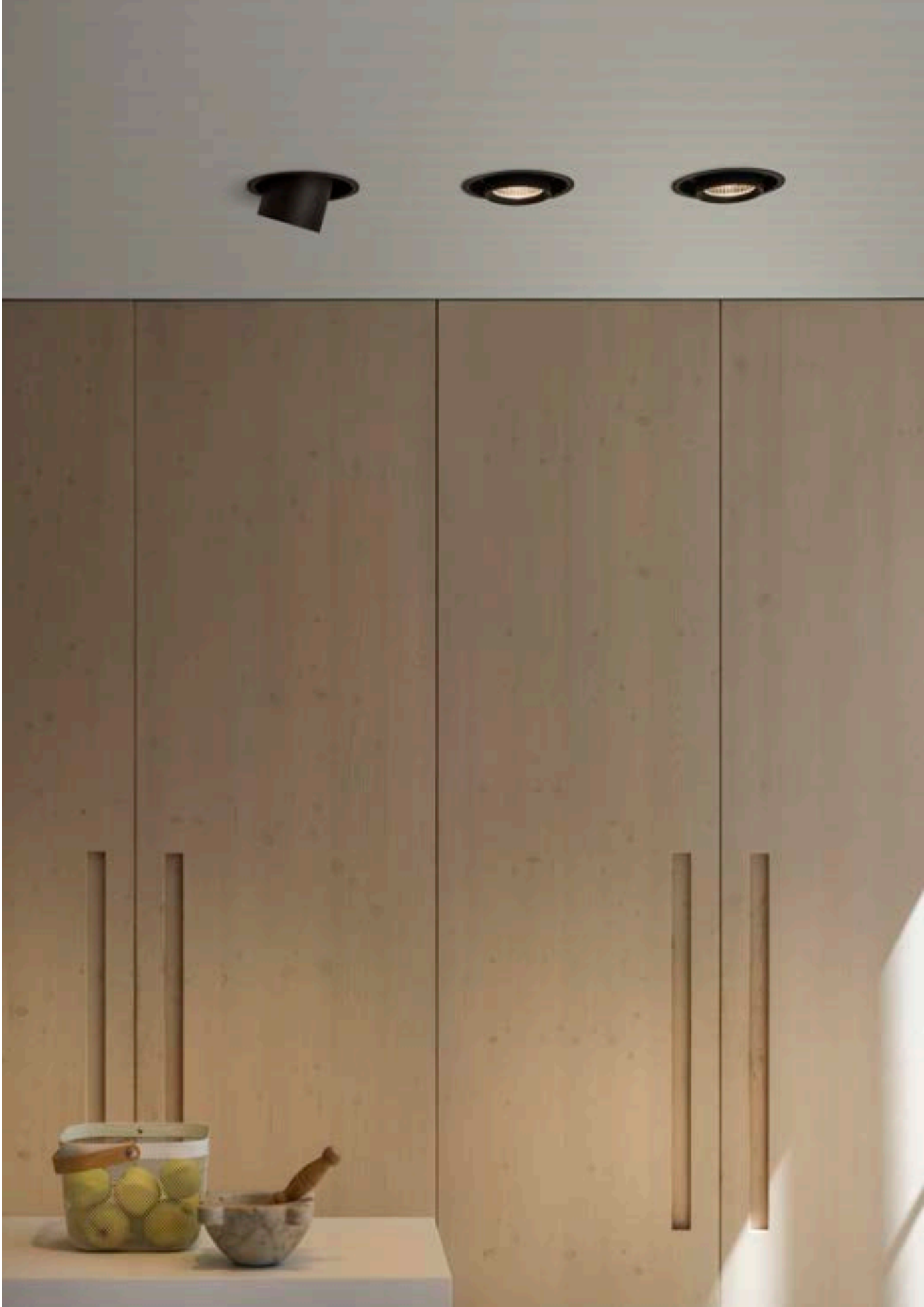
NOVA

Recessed spotlight in die-cast aluminum with round ring, suitable for installation on plasterboard or paneled ceilings. Matt white or matt black finish. Source adjustable 360° and extractable up to 90° in relation to the vertical axis. The high color rendering and maximum orientation flexibility make it ideal for exhibition spaces and for the enhancement of products in showrooms and sales areas in the retail sector.













VIRUS

Recessed aluminum mini-spotlight with round ring, suitable for installation on plasterboard or paneled ceilings. Matt white, matt black, matt gold finish. SMD LED technology; available in 3000K color temperature; CRI \geq 90; IP20 protection; insulation class II; LED useful life 30,000 h L70B50. The high color rendering and small dimensions make it ideal for accent lighting in recesses and shop windows in domestic and retail interior environments.









OUTDOOR LAMPS

FRAGRANCE
OF FLOWERS
REFLECTING
IN THE POOL,
THE SUN
GOING DOWN,
THE GARDEN
LIGHTING UP.
DANCING LIGHTS,
SETTING UP
THE EVENING'S
SCENE.
GLASSES
CLINKING,
GETTING READY
FOR DINNER.





Index

↳

380	Agos
388	Andromeda
392	Djambe
400	Gun
408	Ipotesi
414	Jedi
420	Lolita
428	Sirio
436	Sole
442	Starlight
448	Style
454	Taurus
460	Techo
466	Tesla
472	Vega



AGOS

Powder coated die-cast aluminum body. Satin clear acrylic diffuser. Anthracite, coffee or black color.



















ANDROMEDA

Die-cast aluminum body light with varnish finish. Double frosted Pyrex glass, up-and-down. Available finishes: anthracite, white, coffee, grey or black.



ANDROMEDA

WALL LAMPS OUTDOORS IDEAL LUX







DJAMBE

Powder-coated metal body.
Rough opal color plastic diffuser.
Downward light emission.
Black neoprene cable with plug.
Available finishes: coffee or black.



















GUN

Aluminum body with brushed natural finish or with varnish or various finishes. Pyrex glass diffuser.













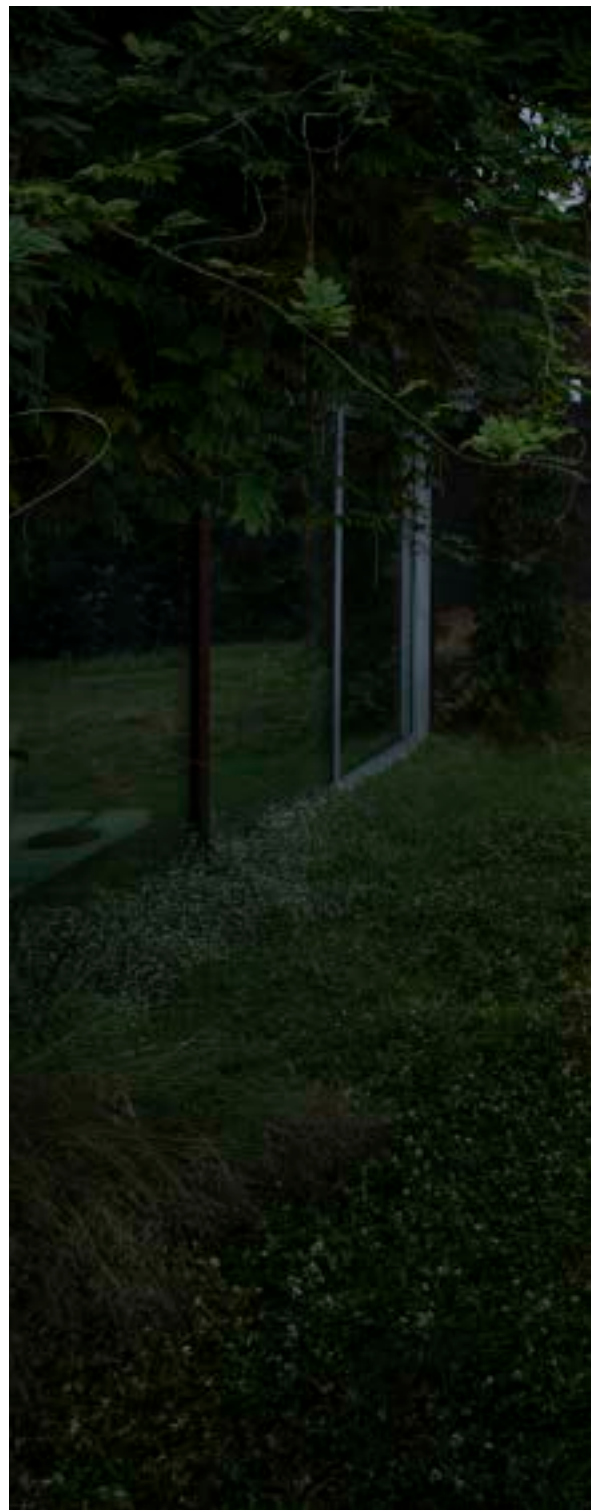






IPOTESI

Total powder painted aluminium frame. Opal polycarbonate diffuser. Black rubber cable with switch, external incorporated driver and plug. Colours: white or black.













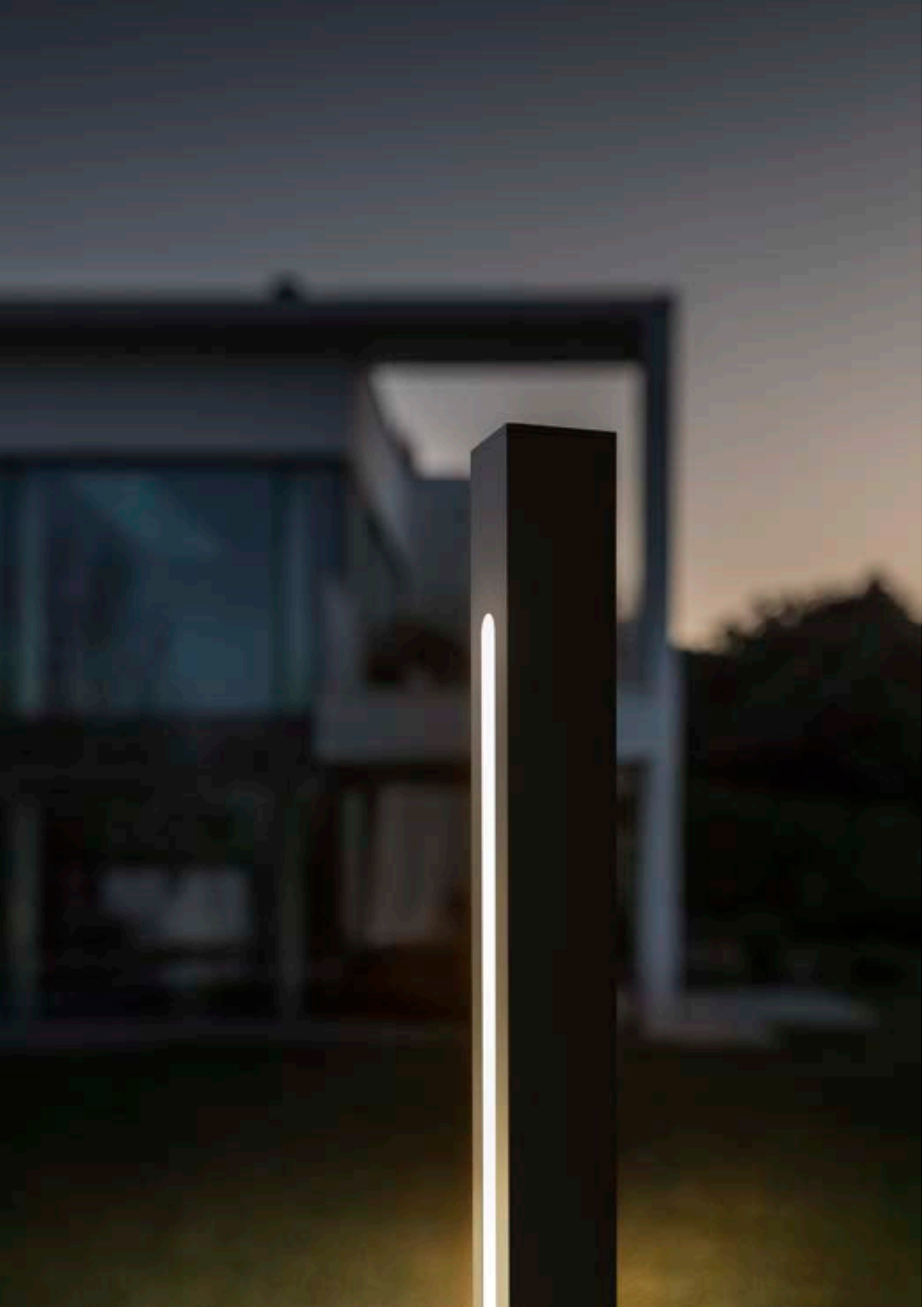


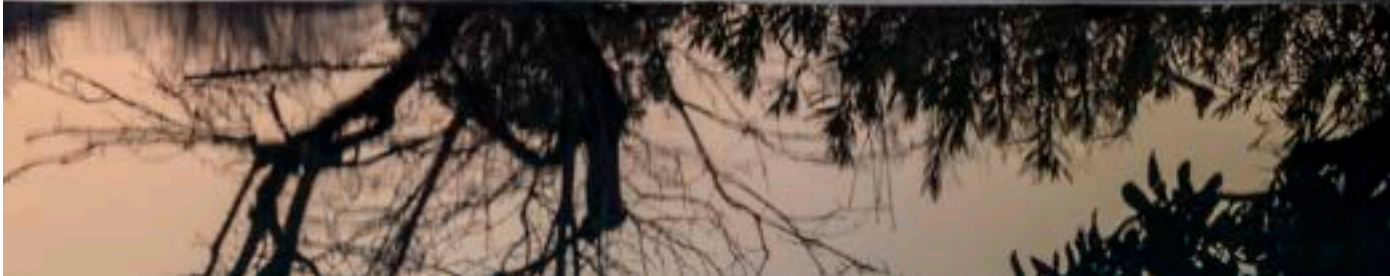
JEDI

Powder-coated aluminium base and body. Shiny opal color polycarbonate diffuser. Supplied with piquet for ground installation. Available finishes: anthracite or black.











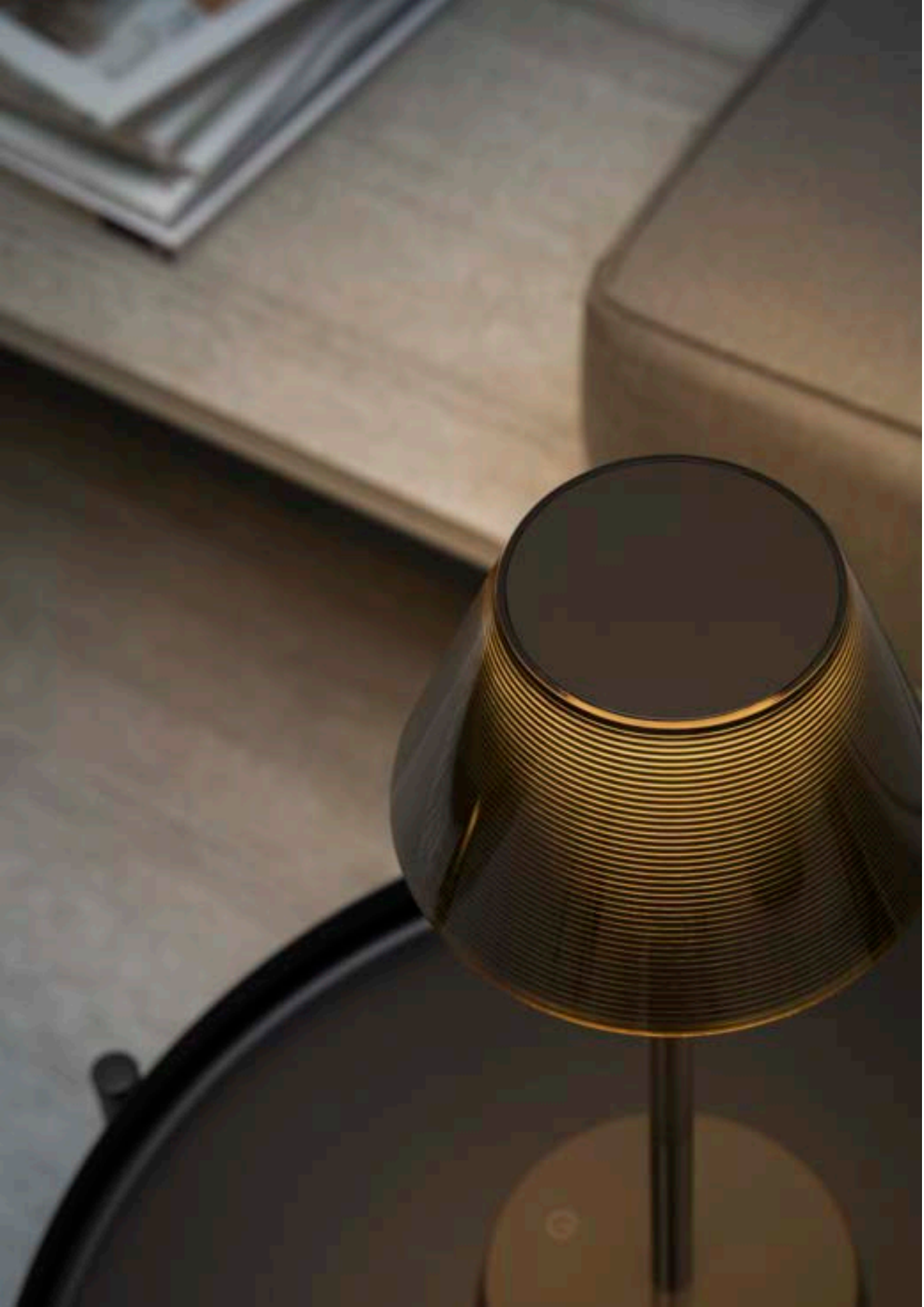


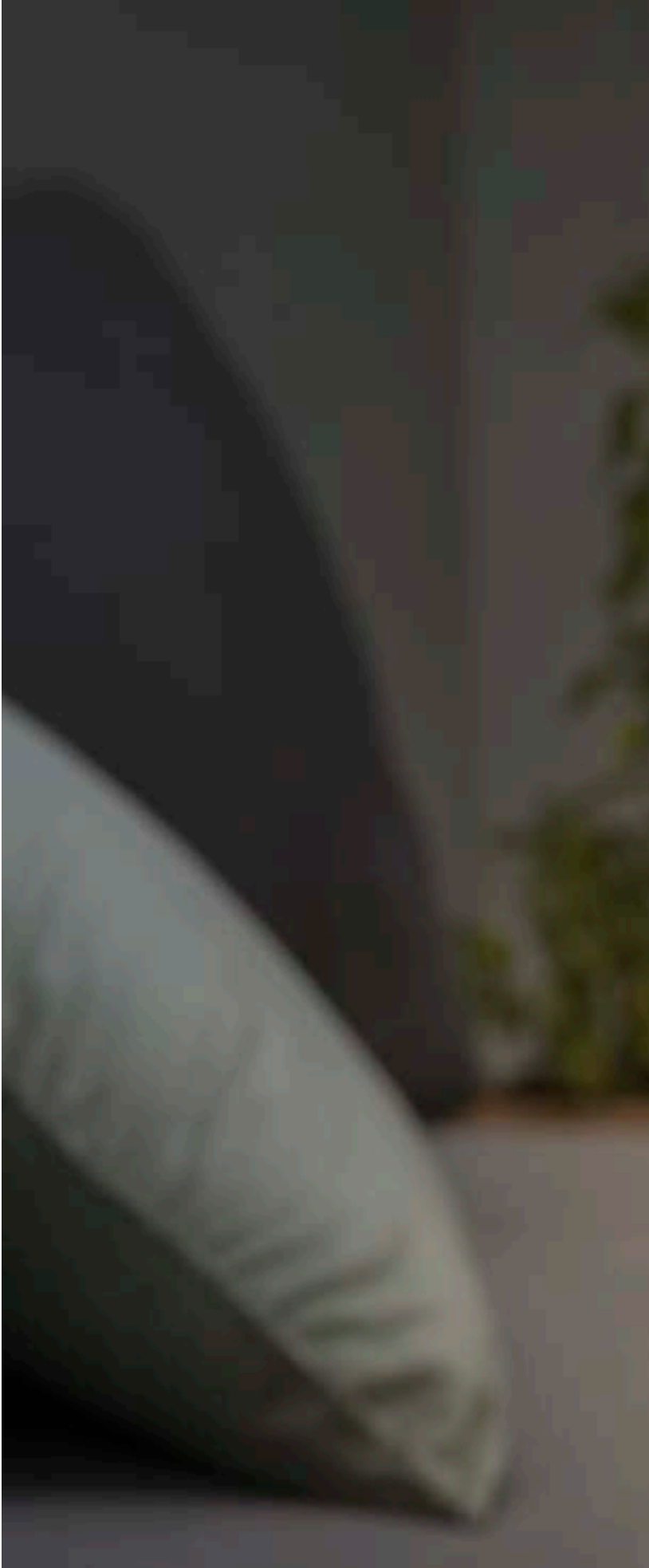
LOLITA

Table lamp with rechargeable battery with white, grey, black or coffee finish. Plastic base. Metal frame. Plastic diffuser. The table lamp has 14 hours autonomy. Battery charging time 7 hours.

















SIRIO

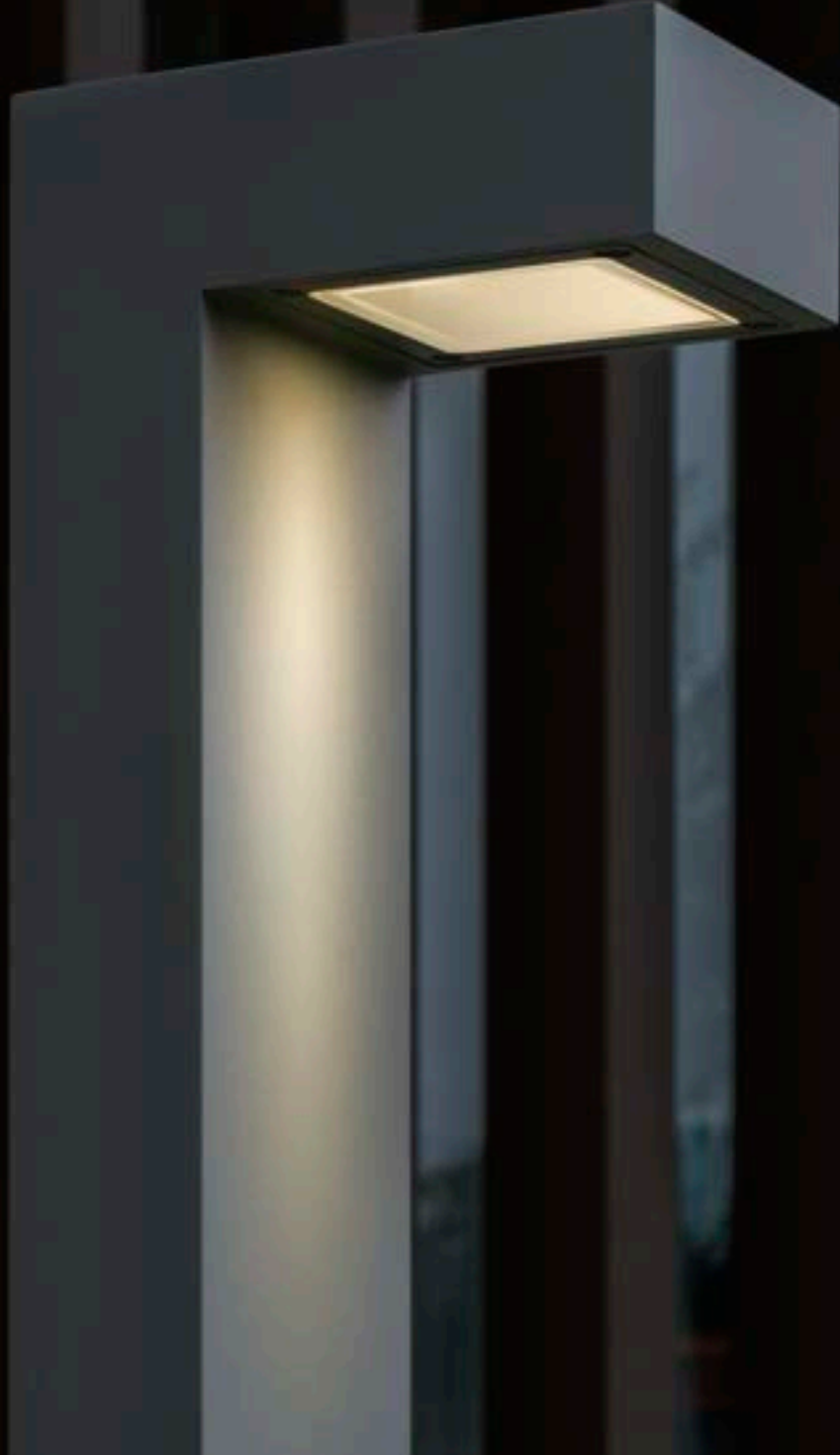
Powder coated aluminum body.
Clear Pyrex glass diffuser. Available
finishes: anthracite, white, coffee,
grey or black.



















SOLE

Opal color plastic diffuser.
Supplied with cable, plug and picket
for the installation on the ground.













STARLIGHT

Aluminum adjustable tracklight with ceiling or peg installation; dark gray anodized and powder coated surface; integrated energy-efficient LED source with high color rendering; available with 3000k and 4000k color temperature; LED useful life 50.000 h. Optional anti-glare screen.













STYLE

Powder coated aluminum body.
Opal color plastic shade.
Integrated LED source. Available
finishes: anthracite, white, coffee,
grey or black.















TAURUS

Walkable recessed projector for floor, wall or ceiling installation. Die-cast aluminum body, round or square ring in 316L stainless steel, glass diffuser. Integrated LED light source; available in the ACCENT versions with 1, 2 or 3 modules individually adjustable $\pm 30^\circ$ using an external pin to widen, narrow or direct the overall light beam; or in the non-adjustable WIDE versions for diffused and uniform lighting.













TECHO

Powder coated die-cast aluminum body. Tempered frosted clear glass diffuser. Available with anthracite, white, grey, coffee or black finish.















TESLA

Powder painted aluminum body.
White plastic screen diffuser.
Downward light emission. Available
finishes: anthracite, white, coffee,
grey or black.















VEGA

Aluminum body with matt powder coating. Clear tempered glass diffuser. Available finishes: anthracite, white, coffee, grey or black.













LIST OF FINISHES



CLEAR



WHITE



FADE CHROME



STEEL



SILVER



CHROME



ALUMINUM



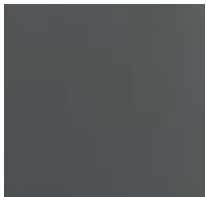
GREY



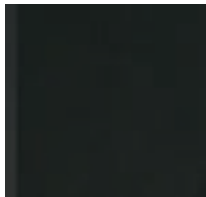
NICKEL



SMOKY GREY



ANTHRACITE



BLACK



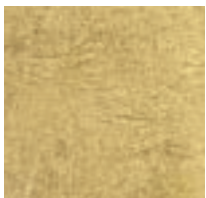
AMBER



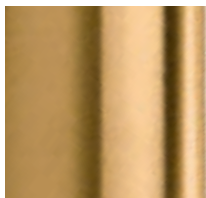
BEIGE



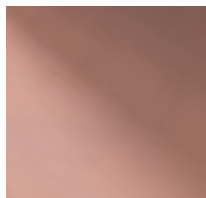
DOVE GREY



GOLD



BRASS



COPPER



COFFEE

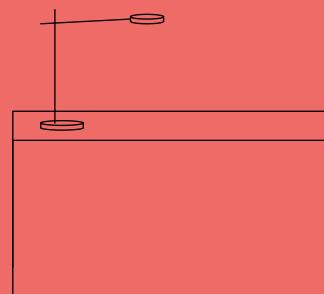
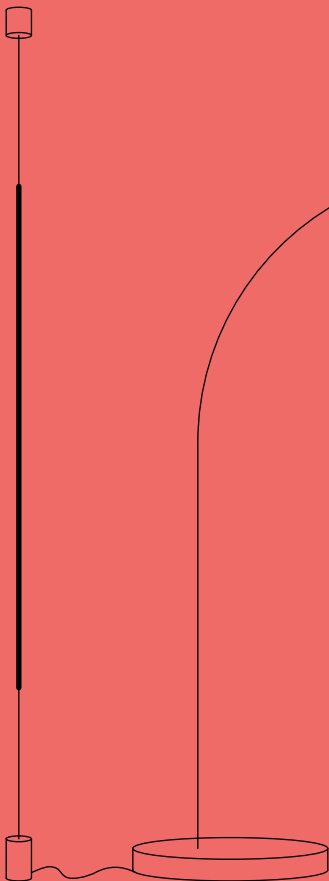
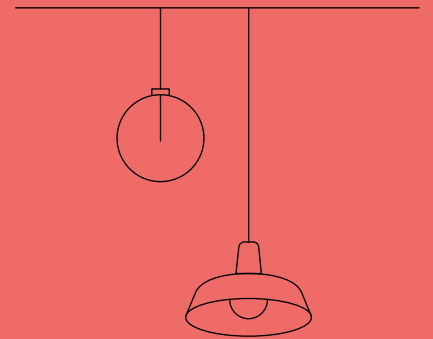
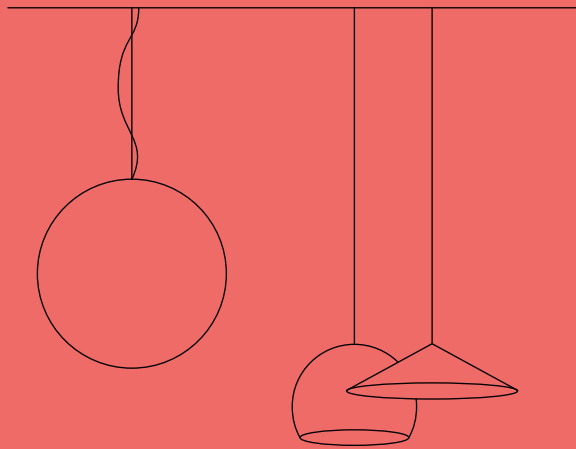


ANTIQUE BRASS

The finishes represented are for illustrative purpose only. The tones are subjected to variations due to the material type used and to its manufacturing which can modify the output,

as a consequence the items classified under the same finish can present some differences concerning color perception.

DATASHEETS



INDOORS DATASHEETS

Decorative lamps:
alphabetical and typology index

↳

BEAN



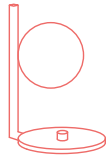
488

EQUINOXE



495

BIRDS



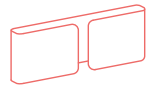
488

ESSENCE



498

CLIP



490

FADE



499

COVER



491

FILO



499

DELTA



492

FLY



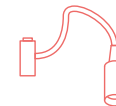
502

DIESIS



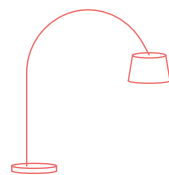
492

FOCUS



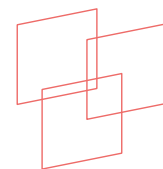
506

DORSALE



493

FRAME



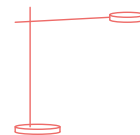
506

DOT



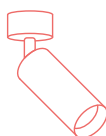
494

FUTURA



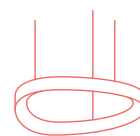
508

DYNAMITE



494

GEMINI



509

LOOK



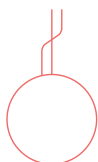
511

PERLAGE



525

MAPA BIANCO



513

PIANO



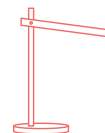
531

MINT



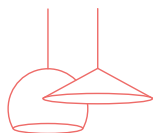
517

PIVOT



532

MIX UP



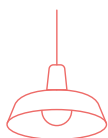
518

SET UP



532

MOBY



519

SPIKE



536

NEMO



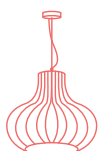
520

ULTRATHIN



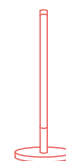
536

ONION



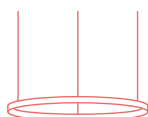
521

YOKO



537

ORACLE SLIM



522

ZIG ZAG



538

OZ



524

Technical lamps:
alphabetical and typology index



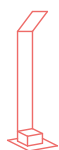
<u>BENTO</u>		<u>540</u>	<u>LIKA</u>		<u>577</u>
<u>DISPLAY</u>		<u>542</u>	<u>LINK</u>		<u>580</u>
<u>EGO</u>		<u>545</u>	<u>LINUS</u>		<u>588</u>
<u>EOS</u>		<u>565</u>	<u>NOVA</u>		<u>589</u>
<u>FLUO</u>		<u>566</u>	<u>QUICK</u>		<u>590</u>
<u>FOX</u>		<u>571</u>	<u>TESI</u>		<u>593</u>
<u>GAME</u>		<u>574</u>	<u>VIRUS</u>		<u>594</u>

OUTDOORS DATASHEETS

Outdoor lamps:
alphabetical and typology index

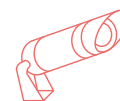
↳

AGOS



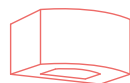
595

STARLIGHT



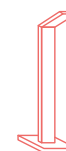
601

ANDROMEDA



595

STYLE



602

DJAMBE



596

TAURUS



603

GUN



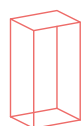
596

TECHO



605

IPOTESI



597

TESLA



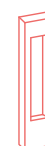
605

JEDI



597

VEGA



606

LOLITA



598

SIRIO



598

SOLE



599

BEAN

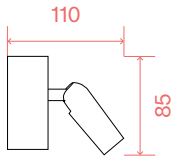
WALL



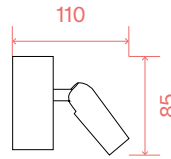
IP20



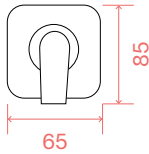
PHOTO p. 152



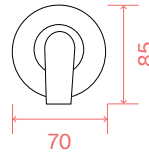
FINISH	CODE	€
White	260648	48
Nickel	260679	48
Black	260655	48
Brass	260662	48



FINISH	CODE	€
White	260600	48
Nickel	260631	48
Black	260617	48
Brass	260624	48



LED source 3000 K,
30.000 h life.



LED source 3000 K,
30.000 h life.



0,180 Kg
0,0008 m³
LED 3W / 280 lm

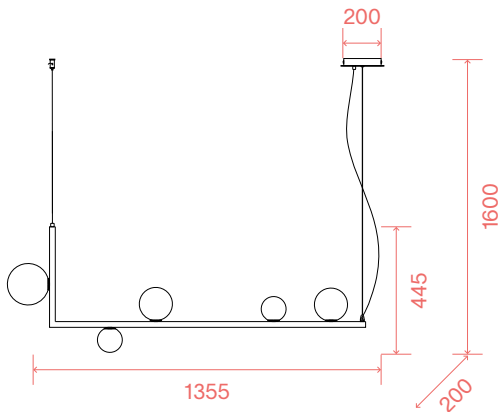
0,180 Kg
0,0005 m³
LED 3W / 280 lm

BIRDS

SUSPENSION



IP20



(RECOMMENDED)

LUMEN	CCT	CODE	€
510 lm	3000 K	305486	6

FINISH	CODE	€
Black	273648	283

Bulbs LED G9 4W 3000 K
included. Cod. 209043

2,750 Kg
0,1353 m³
G9 max 5 x 15W

BIRDS

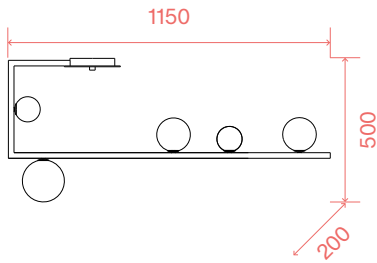
CEILING



IP20



PHOTO p. 122



2,800 Kg
0,1535 m³
G9 max 5 x 15W

(RECOMMENDED)

LUMEN	CCT	CODE	€
510 lm	3000 K	305486	6

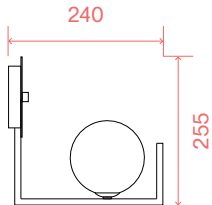
FINISH	CODE	€
Black	273631	278

Bulbs LED G9 4W 3000 K included. Cod. 209043

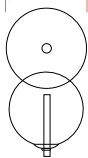
WALL



IP20



130



(RECOMMENDED)

LUMEN	CCT	CODE	€
510 lm	3000 K	305486	6

FINISH	CODE	€
Black	273655	73

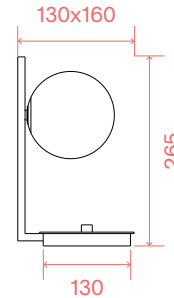
Bulbs LED G9 4W 3000 K included. Cod. 209043

0,670 Kg
0,0192 m³
G9 max 1 x 15W

TABLE



IP20



0,900 Kg
0,0163 m³
G9 max 1 x 15W

(RECOMMENDED)

LUMEN	CCT	CODE	€
510 lm	3000 K	305486	6

FINISH	CODE	€
Black	273679	86

Bulbs LED G9 4W 3000 K included. Cod. 209043



BIRDS

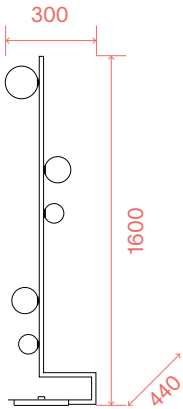
FLOOR



IP20



PHOTO p. 238



(RECOMMENDED)

LUMEN	CCT	CODE	€
510 lm	3000 K	305486	6

FINISH	CODE	€
Black	273662	340

Bulbs LED G9 4W 3000 K included. Cod. 209043



5,640 Kg
0,1536 m³
G9 max 5 x 15W

CLIP

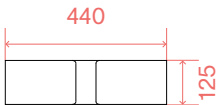
WALL



IP20

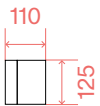


PHOTO p. 156



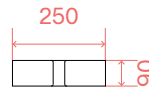
(RECOMMENDED)

LUMEN	CCT	CODE	€
430 lm	3000 K	101279	2,60



FINISH	CODE	€
White	014166	107
Silver	088273	107
Chrome	031361	107
Gold	088266	107
Coffee	187365	107

1,210 Kg
0,0161 m³
E27 max 2 x 60W



(RECOMMENDED)

LUMEN	CCT	CODE	€
510 lm	3000 K	305486	6



FINISH	CODE	€
White	049236	95
Silver	091136	95
Chrome	049229	95
Gold	091129	95
Coffee	170923	95

0,680 Kg
0,0035 m³
G9 max 2 x 40W

Bulbs LED G9 4W 3000 K included. Cod. 209043

COVER

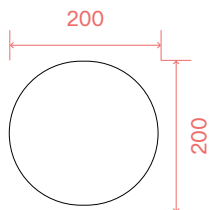
WALL / CEILING



IP20



PHOTO p. 160

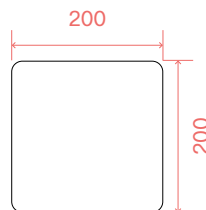


FINISH	CODE	€
White	195711	100
Black	088273	100

LED source 3000 K, 30.000 h life.

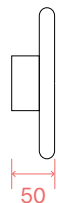


0,690 Kg
0,0028 m³
LED 11W / 1000 lm

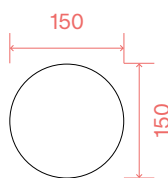


FINISH	CODE	€
White	195735	100
Black	195773	100

LED source 3000 K, 30.000 h life.

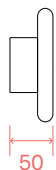


0,860 Kg
0,0028 m³
LED 11W / 1000 lm

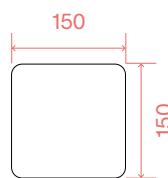


FINISH	CODE	€
White	195704	88
Black	195742	88

LED source 3000 K, 30.000 h life.

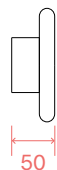


0,390 Kg
0,0018 m³
LED 9,5W / 830 lm



FINISH	CODE	€
White	195728	88
Black	195766	88

LED source 3000 K, 30.000 h life.



0,510 Kg
0,0018 m³
LED 9,5W / 830 lm

DELTA

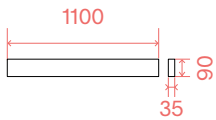
WALL



IP20



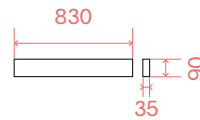
PHOTO p. 166



2,400 Kg
0,0102 m³
LED 37W
4550/4800 lm

FINISH	CCT	CODE	€
White	3000 K	287607	185
White	4000 K	307053	185
Black	3000 K	287591	185
Black	4000 K	307060	185

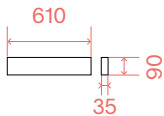
LED source 3000/4000 K,
50.000 h life.



0,900 Kg
0,0078 m³
LED 30W
3600/3800 lm

FINISH	CCT	CODE	€
White	3000 K	287621	160
White	4000 K	307039	160
Black	3000 K	287614	160
Black	4000 K	307046	160

LED source 3000/4000 K,
50.000 h life.



0,950 Kg
0,0058 m³
LED 19,5W
2050/2150 lm

FINISH	CCT	CODE	€
White	3000 K	287645	110
White	4000 K	307015	110
Black	3000 K	287638	110
Black	4000 K	307022	110

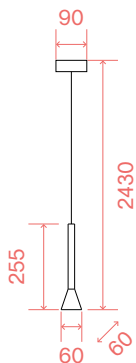
LED source 3000/4000 K,
50.000 h life.

DIESIS

SUSPENSION



IP20



0,450 Kg
0,0054 m³
LED 7W / 580 lm

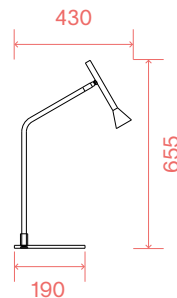
FINISH	CODE	€
Nickel	285122	96
Black	279770	96
Brass	279794	96

LED source 3000 K,
20.000 h life.

TABLE



IP20



1,700 Kg
0,0637 m³
LED 6,5W / 500 lm

FINISH	CODE	€
Nickel	291093	185
Black	283333	185
Brass	291109	185

LED source 3000 K,
30.000 h life.



DIESIS

FLOOR



IP20



PHOTO p. 244



FINISH	CODE	€
Nickel	285337	205
Black	279800	205
Brass	285344	205



LED source 3000 K,
20.000 h life.



3,500 Kg
0,0222 m³
LED 4,5W / 300 lm

DORSALE

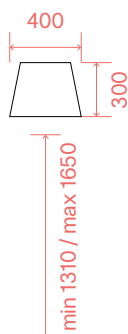
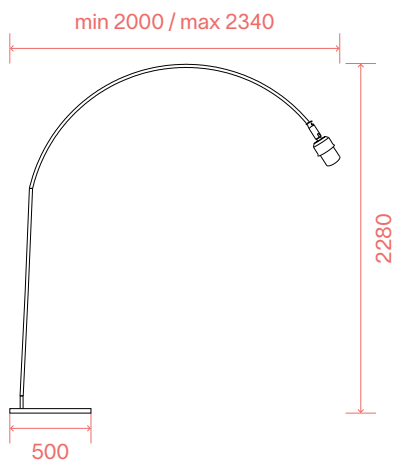
FLOOR



IP20



PHOTO p. 252



12,000 Kg
0,0856 m³
E27 max 1 x 60W

0,430 Kg
0,0709 m³

(RECOMMENDED)

LUMEN	CCT	CODE	€
1050 lm	3000 K	101347	8

FINISH	CODE	€
White	286686	600
Chrome	286662	600
Black	286679	600



PARALUME

FINISH	CODE	€
White	046723	75
Chrome	041742	75
Black	046471	75

DOT

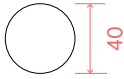
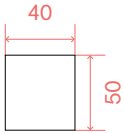
CEILING



IP20



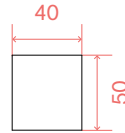
PHOTO p. 126



FINISH	CCT	CODE	€
White	3000 K	299419	45
White	4000 K	306513	45
Black	3000 K	299402	45
Black	4000 K	306520	45

LED source 3000/4000 K, 50.000 h life.

0,600 Kg
0,0004 m³
LED 4W / 320/370 lm



FINISH	CCT	CODE	€
White	3000 K	319797	67
Black	3000 K	319803	67

LED source 3000/4000 K, 50.000 h life.

0,100 Kg
0,0004 m³
LED 4W / 320/370 lm

DYNAMITE

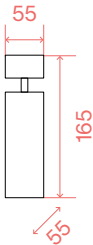
WALL / CEILING



IP20



PHOTO p. 130



(RECOMMENDED)

LUMEN	CCT	CODE	€
540 lm	3000 K	123943	3,50

FINISH	CODE	€
White	231495	98
Black	231471	98
Brass	244662	98

Bulbs LED GU10 7W
3000 K included. Cod. 123943

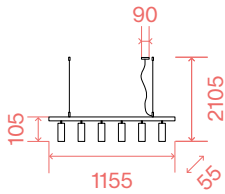
0,430 Kg
0,0037 m³
GU10 max 1 x 28W

DYNAMITE

SUSPENSION



IP20



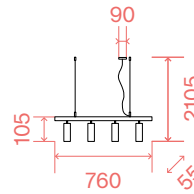
(RECOMMENDED)

LUMEN	CCT	CODE	€
540 lm	3000 K	123943	3,50

FINISH	CODE	€
White	231433	350
Black	231396	350
Brass	244648	350

2,700 Kg
0,0360 m³
GU10 max 6 x 28W

Bulbs LED GU10 7W
3000 K included. Cod. 123943



(RECOMMENDED)

LUMEN	CCT	CODE	€
540 lm	3000 K	123943	3,50

FINISH	CODE	€
White	231372	275
Black	231341	275
Brass	244624	275

2,310 Kg
0,0243 m³
GU10 max 4 x 28W

Bulbs LED GU10 7W
3000 K included. Cod. 123943

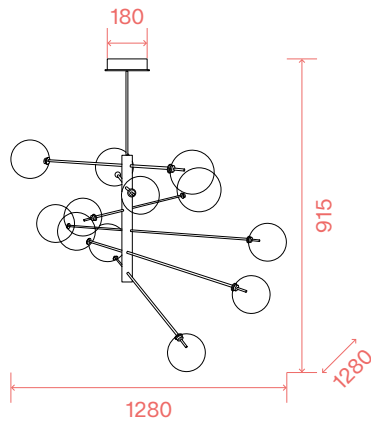
EQUINOXE

SUSPENSION



IP20

↑ PHOTO p. 16



(RECOMMENDED)

LUMEN	CCT	CODE	€
200 lm	3000 K	222257	4

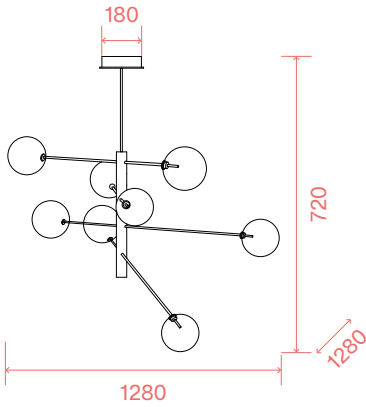
FINISH	CODE	€
Chrome	200118	950
Brass	200125	950

Bulbs LED G4 2W 3000 K
included. Cod. 222257

5,540 Kg
0,1304 m³
G4 max 12 x 2W

EQUINOXE

SUSPENSION



4,460 Kg
0,1427 m³
G4 max 8 x 2W

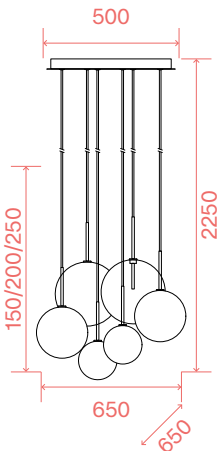
(RECOMMENDED)

LUMEN	CCT	CODE	€
200 lm	3000 K	222257	4

FINISH	CODE	€
Chrome	275178	750
Brass	275215	750

Bulbs LED G4 2W 3000 K included. Cod. 222257

SUSPENSION



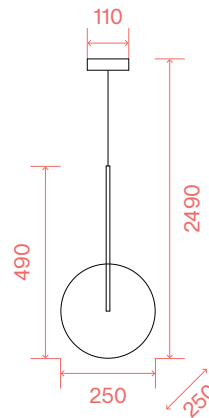
5,200 Kg
0,1274 m³
G4 max 6 x 2W

(RECOMMENDED)

LUMEN	CCT	CODE	€
200 lm	3000 K	222257	4

FINISH	CODE	€
Chrome	317250	650
Brass	317243	650

Bulbs LED G4 2W 3000 K included. Cod. 222257



0,850 Kg
0,0326 m³
G4 max 1 x 2W

(RECOMMENDED)

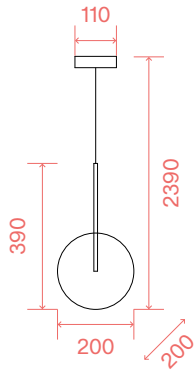
LUMEN	CCT	CODE	€
200 lm	3000 K	222257	4

FINISH	CODE	€
Chrome	306551	180
Brass	277394	180

Bulbs LED G4 2W 3000 K included. Cod. 222257

EQUINOXE

SUSPENSION



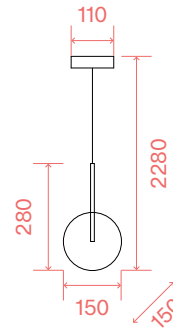
(RECOMMENDED)

LUMEN	CCT	CODE	€
200 lm	3000 K	222257	4

FINISH	CODE	€
Chrome	306544	140
Brass	277387	140

Bulbs LED G4 2W 3000 K included. Cod. 222257

0,700 Kg
0,0211 m³
G4 max 1 x 2W



(RECOMMENDED)

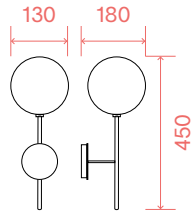
LUMEN	CCT	CODE	€
200 lm	3000 K	222257	4

FINISH	CODE	€
Chrome	306537	120
Brass	277370	120

Bulbs LED G4 2W 3000 K included. Cod. 222257

0,640 Kg
0,0170 m³
G4 max 1 x 2W

WALL



(RECOMMENDED)

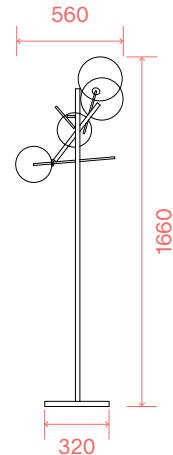
LUMEN	CCT	CODE	€
200 lm	3000 K	222257	4

FINISH	CODE	€
Chrome	200132	131
Brass	200149	131

Bulbs LED G4 2W 3000 K included. Cod. 222257

0,990 Kg
0,0243 m³
G4 max 1 x 2W

FLOOR



(RECOMMENDED)

LUMEN	CCT	CODE	€
200 lm	3000 K	222257	4

FINISH	CODE	€
Chrome	290959	500
Brass	290966	500

Bulbs LED G4 2W 3000 K included. Cod. 222257



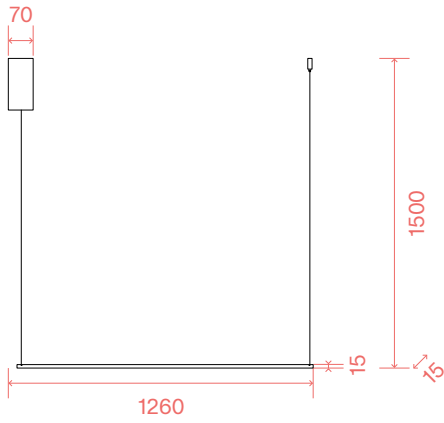
6,500 Kg
0,0882 m³
G4 max 4 x 2W

ESSENCE

SUSPENSION



IP20



FINISH	CODE	€
White	285085	275
Black	285092	275

LED source 3000 K,
30.000 h life.

0,900 Kg
0,0165 m³
LED 20W / 2650 lm

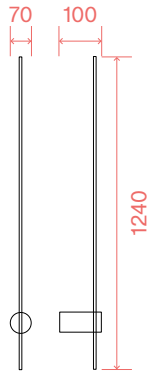
WALL / CEILING



IP20



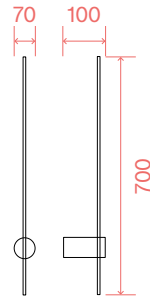
PHOTO p. 172



FINISH	CODE	€
White	265575	240
Black	285108	240

LED source 3000 K,
30.000 h life.

1,040 Kg
0,0163 m³
LED 20W / 2650 lm



FINISH	CODE	€
White	285115	182
Black	265643	182

LED source 3000 K,
30.000 h life.

0,800 Kg
0,0205 m³
LED 12,5W / 1650 lm

FADE

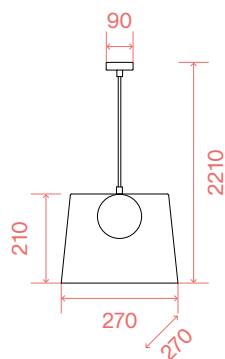
SUSPENSION



IP20



PHOTO p. 20



(RECOMMENDED)

LUMEN	CCT	CODE	€
510 lm	3000 K	305486	6

FINISH	CODE	€
Chrome	271293	200
Amber	271316	200
Copper	271309	200



Bulbs LED G9 4W 3000 K included. Cod. 209043

1,900 Kg
0,0370 m³
G9 max 1 x 15W

FILO

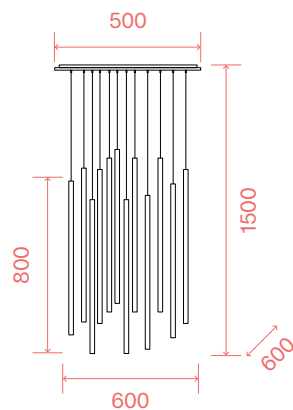
SUSPENSION



IP20



PHOTO p. 26



FINISH	CODE	€
White	263441	690
Black	263434	690
Brass	263663	690



LED source 3000 K,
30.000 h life.

8,600 Kg
0,1232 m³
LED 25W / 3150 lm

FILO

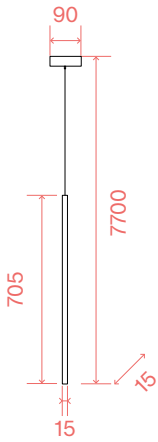
SUSPENSION



IP20



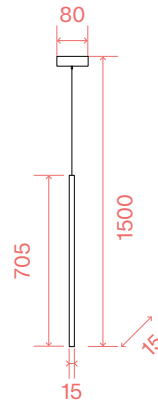
IP20



FINISH	CODE	€
White	300818	180
Black	300801	180
Brass	300825	180

LED source 3000 K, 20.000 h life.

0,830 Kg
0,0105 m³
LED 4W / 160 lm



FINISH	CODE	€
White	263687	125
Black	263670	125
Brass	263700	125

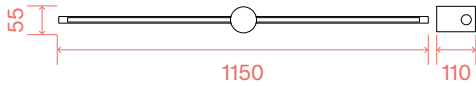
LED source 3000 K, 30.000 h life.

0,530 Kg
0,0142 m³
LED 3,5W / 230 lm

WALL / CEILING



IP44



FINISH	CODE	€
White	327778	200
Black	310152	200
Brass	327785	200

LED source 3000 K, 20.000 h life.



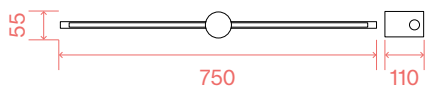
0,610 Kg
0,0138 m³
LED 16W / 2000 lm

FILO

WALL / CEILING



IP44



0,500 Kg
0,0093 m³
LED 12,5W / 1450 lm

FINISH	CODE	€
White	310138	180
Black	310145	180
Brass	327792	180

LED source 3000 K,
20.000 h life.

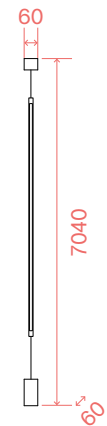


FLOOR



IP20

PHOTO p. 264



FINISH	CODE	€
White	301051	250
Black	301068	250
Brass	301075	250

LED source 3000 K,
20.000 h life.



1,200 Kg
0,0124 m³
LED 15W / 1900 lm

TABLE



IP20

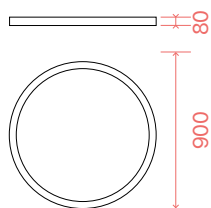


FINISH	CODE	€
White	310107	150
Black	310114	150
Brass	310121	150

LED source 3000 K,
20.000 h life.



0,500 Kg
0,0204 m³
LED 10,5W / 1200 lm



LED SMD SAMSUNG, DRIVER TRIDONIC ON/OFF (INCLUDED)

POWER	BEAM	LUMEN	CCT	FINISH	CODE	€
65 W	87°	9400 lm	3000 K	White	270326	1180
65 W	87°	9400 lm	3000 K	Black	306629	1180
65 W	87°	9900 lm	4000 K	White	270241	1180
65 W	87°	9900 lm	4000 K	Black	306636	1180

DIMMABLE DRIVER (NOT INCLUDED/OPTIONAL)

	POWER	OUTPUT	MEASURE	CODE	€
1-10V	68 W	1400 mA	130 x 25 x 75 mm	270357	125
DALI / Push	100 W	1400 mA	140 x 30 x 100 mm	270388	180

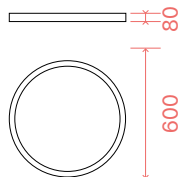
UPLIGHT (NOT INCLUDED/OPTIONAL)

POWER	BEAM	LUMEN	CCT	CODE	€
25 W	120°	3650 lm	3000 K	271002	225
25 W	120°	3850 lm	4000 K	270715	225

6,900 Kg
0,0903 m³

KIT PENDANT
(OPTIONAL)
White
cod. 254289, € 50
Black
cod. 307244, € 50

LED SMD SAMSUNG, DRIVER TRIDONIC ON/OFF (INCLUDED)



POWER	BEAM	LUMEN	CCT	FINISH	CODE	€
53 W	87°	7500 lm	3000 K	White	270302	610
53 W	87°	7500 lm	3000 K	Black	292205	610
53 W	87°	8000 lm	4000 K	White	270319	610
53 W	87°	8000 lm	4000 K	Black	306612	610

DIMMABLE DRIVER (NOT INCLUDED/OPTIONAL)

	POWER	OUTPUT	MEASURE	CODE	€
1-10V	60 W	1400 mA	124 x 23 x 82 mm	270340	112
DALI / Push	60 W	1400 mA	125 x 28 x 85 mm	270371	135

UPLIGHT (NOT INCLUDED/OPTIONAL)

POWER	BEAM	LUMEN	CCT	CODE	€
18 W	120°	2650 lm	3000 K	270401	150
18 W	120°	2750 lm	4000 K	270265	150

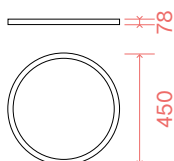
4,500 Kg
0,0423 m³

KIT PENDANT
(OPTIONAL)
White
cod. 254289, € 50
Black
cod. 307244, € 50

FLY

WALL / CEILING

⊕ IP40 MacAdam: SDCM 3 UGR: <19 CRI >80 Durta LED: 50.000 h



3,700 Kg
0,0250 m³

KIT PENDANT
(OPTIONAL)
White
cod. 254289, € 50
Black
cod. 307244, € 50

LED SMD SAMSUNG, DRIVER TRIDONIC ON/OFF (INCLUDED)

POWER	BEAM	LUMEN	CCT	FINISH	CODE	€
26 W	87°	3700 lm	3000 K	White	254272	420
26 W	87°	3700 lm	3000 K	Black	306599	420
26 W	87°	3900 lm	4000 K	White	270296	420
26 W	87°	3900 lm	4000 K	Black	306605	420

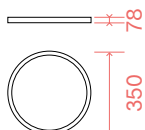
DIMMABLE DRIVER (NOT INCLUDED/OPTIONAL)

	POWER	OUTPUT	MEASURE	CODE	€
1-10V / Push	32 W	700 mA	94 x 21 x 67 mm	270586	75
DALI / Push	38 W	700 mA	94 x 21 x 67 mm	270593	95

UPLIGHT (NOT INCLUDED/OPTIONAL)

POWER	BEAM	LUMEN	CCT	CODE	€
12 W	120°	1600 lm	3000 K	270258	85
12 W	120°	1700 lm	4000 K	270395	85

LED SMD SAMSUNG, DRIVER TRIDONIC ON/OFF (INCLUDED)



3,000 Kg
0,0160 m³

KIT PENDANT
(OPTIONAL)
White
cod. 254289, € 50
Black
cod. 307244, € 50

POWER	BEAM	LUMEN	CCT	FINISH	CODE	€
18 W	87°	2650 lm	3000 K	White	270272	315
18 W	87°	2650 lm	3000 K	Black	306575	315
18 W	87°	2800 lm	4000 K	White	270289	315
18 W	87°	2800 lm	4000 K	Black	306582	315

DIMMABLE DRIVER (NOT INCLUDED/OPTIONAL)

	POWER	OUTPUT	MEASURE	CODE	€
1-10V / Push	20 W	500 mA	108 x 22 x 52 mm	270333	65
DALI	20 W	500 mA	108 x 22 x 52 mm	270364	85

UPLIGHT (NOT INCLUDED/OPTIONAL)

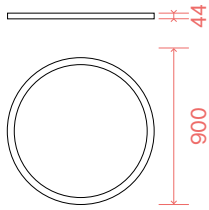
POWER	BEAM	LUMEN	CCT	CODE	€
12 W	120°	1600 lm	3000 K	270258	85
12 W	120°	1700 lm	4000 K	270395	85

FLY SLIM

WALL / CEILING



IP40 MacAdam: SDCM 3 UGR: <19 CRI >80 Durta LED: 50.000 h



13,000 Kg
0,1448 m³

KIT PENDANT
(OPTIONAL)

White
cod. 254289, € 50

LED SMD SAMSUNG, DRIVER TRIDONIC ON/OFF (INCLUDED)

POWER	BEAM	LUMEN	CCT	FINISH	CODE	€
65 W	87°	9400 lm	3000 K	White	306681	1125
65 W	87°	9900 lm	4000 K	White	306698	1125

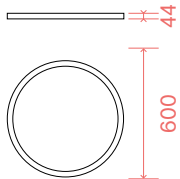
DIMMABLE DRIVER (NOT INCLUDED/OPTIONAL)

	POWER	OUTPUT	MEASURE	CODE	€
1-10V	68 W	1400 mA	130 x 25 x 75 mm	270357	125
DALI / Push	100 W	1400 mA	140 x 30 x 100 mm	270388	180

UPLIGHT (NOT INCLUDED/OPTIONAL)

POWER	BEAM	LUMEN	CCT	CODE	€
25 W	120°	3650 lm	3000 K	271002	225
25 W	120°	3850 lm	4000 K	270715	225

LED SMD SAMSUNG, DRIVER TRIDONIC ON/OFF (INCLUDED)



5,800 Kg
0,0699 m³

KIT PENDANT
(OPTIONAL)

White
cod. 254289, € 50

POWER	BEAM	LUMEN	CCT	FINISH	CODE	€
53 W	87°	7500 lm	3000 K	White	292250	575
53 W	87°	8000 lm	4000 K	White	306674	575

DIMMABLE DRIVER (NOT INCLUDED/OPTIONAL)

	POWER	OUTPUT	MEASURE	CODE	€
1-10V	60 W	1400 mA	124 x 23 x 82 mm	270340	112
DALI / Push	60 W	1400 mA	125 x 28 x 85 mm	270371	135

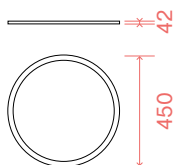
UPLIGHT (NOT INCLUDED/OPTIONAL)

POWER	BEAM	LUMEN	CCT	CODE	€
18 W	120°	2650 lm	3000 K	270401	150
18 W	120°	2750 lm	4000 K	270265	150

FLY SLIM

WALL / CEILING

⊕ IP40 MacAdam: SDCM 3 UGR: <19 CRI >80 Durta LED: 50.000 h



3,750 Kg
0,0170 m³

KIT PENDANT
(OPTIONAL)
White
cod. 254289, € 50

LED SMD SAMSUNG, DRIVER TRIDONIC ON/OFF (INCLUDED)

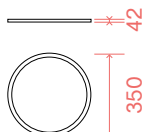
POWER	BEAM	LUMEN	CCT	FINISH	CODE	€
26 W	87°	3700 lm	3000 K	White	292236	390
26 W	87°	3900 lm	4000 K	White	306667	390

DIMMABLE DRIVER (NOT INCLUDED/OPTIONAL)

	POWER	OUTPUT	MEASURE	CODE	€
1-10V / Push	32 W	700 mA	94 x 21 x 67 mm	270586	75
DALI / Push	38 W	700 mA	94 x 21 x 67 mm	270593	95

UPLIGHT (NOT INCLUDED/OPTIONAL)

POWER	BEAM	LUMEN	CCT	CODE	€
12 W	120°	1600 lm	3000 K	270258	85
12 W	120°	1700 lm	4000 K	270395	85



2,700 Kg
0,0105 m³

KIT PENDANT
(OPTIONAL)
White
cod. 254289, € 50

LED SMD SAMSUNG, DRIVER TRIDONIC ON/OFF (INCLUDED)

POWER	BEAM	LUMEN	CCT	FINISH	CODE	€
18 W	87°	2650 lm	3000 K	White	306643	295
18 W	87°	2800 lm	4000 K	White	306650	295

DIMMABLE DRIVER (NOT INCLUDED/OPTIONAL)

	POWER	OUTPUT	MEASURE	CODE	€
1-10V / Push	20 W	500 mA	108 x 22 x 52 mm	270333	65
DALI	20 W	500 mA	108 x 22 x 52 mm	270364	85

UPLIGHT (NOT INCLUDED/OPTIONAL)

POWER	BEAM	LUMEN	CCT	CODE	€
12 W	120°	1600 lm	3000 K	270258	85
12 W	120°	1700 lm	4000 K	270395	85

FOCUS

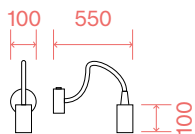
WALL



IP20



PHOTO p. 178

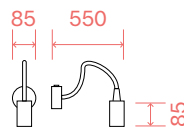


FINISH	CODE	€
White	097183	71
Chrome	097206	71
Black	097190	71

0,400 Kg
0,0025 m³
LED 4W / 210 lm



LED source 3000 K,
30.000 h life.



FINISH	CODE	€
White	203171	75
Chrome	203188	75
Black	203195	75

0,410 Kg
0,0020 m³
LED 3,5W / 280 lm



LED source 3000 K,
20.000 h life.



FRAME

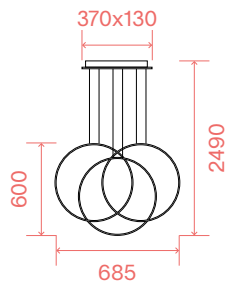
SUSPENSION



IP20



PHOTO p. 30

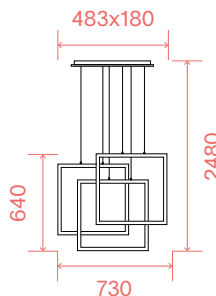


FINISH	CODE	€
White	269351	355
Black	269337	355



LED source 3000 K,
30.000 h life.

3,500 Kg
0,1050 m³
LED 82W / 7300 lm



FINISH	CODE	€
White	253596	555
Black	269375	555



LED source 3000 K,
30.000 h life.

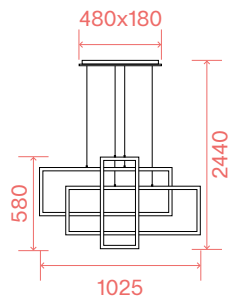
4,270 Kg
0,0689 m³
LED 80W / 9100 lm

FRAME

SUSPENSION



IP20



FINISH	CODE	€
White	253589	550
Black	269382	550

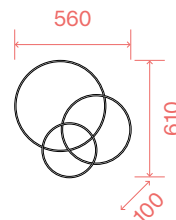
LED source 3000 K, 30.000 h life.

4,300 Kg
0,2100 m³
LED 93W / 10700 lm

WALL / CEILING



IP20 PHOTO p. 142



FINISH	CODE	€
White	255019	320
Black	269825	320

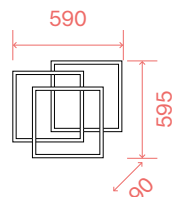
LED source 3000 K, 30.000 h life.

1,600 Kg
0,0458 m³
LED 41W / 5250 lm

WALL / CEILING



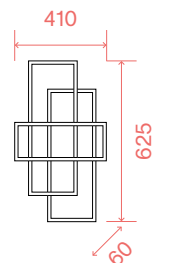
IP20



FINISH	CODE	€
White	230702	320
Black	270678	320

LED source 3000 K, 30.000 h life.

1,430 Kg
0,0530 m³
LED 35W / 4950 lm



FINISH	CODE	€
White	230726	290
Black	270661	290

LED source 3000 K, 30.000 h life.

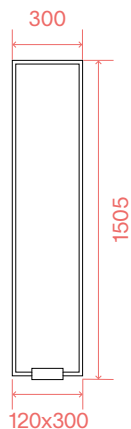
1,240 Kg
0,0264 m³
LED 31W / 4250 lm

FRAME

FLOOR



IP20



FINISH	CODE	€
White	299624	450
Black	299617	450

LED source 3000 K,
30.000 h life.



10,300 Kg
0,0525 m³
LED 30W / 3000 lm

FUTURA

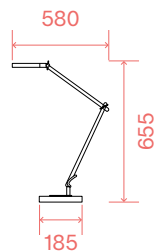
TABLE



IP20



PHOTO p. 198



FINISH	CODE	€
White	272078	130
Aluminum	204895	130
Black	204888	130

LED source 4000 K,
25.000 h life.

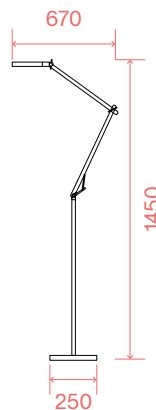


1,830 Kg
0,0069 m³
LED 12,5W / 1100 lm

FLOOR



IP20



FINISH	CODE	€
White	272085	190
Aluminum	204956	190
Black	204949	190

LED source 4000 K,
25.000 h life.



4,440 Kg
0,0095 m³
LED 12,5W / 1100 lm

GEMINI

SUSPENSION



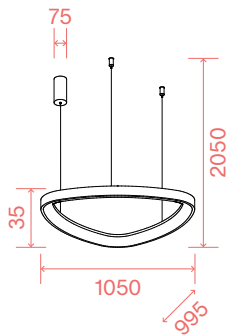
ON-OFF



DALI/PUSH IP20



PHOTO p. 38



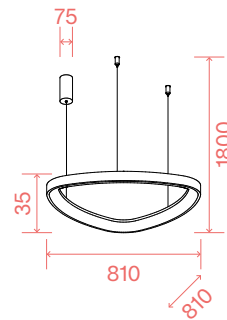
ON-OFF

FINISH	CODE	€
White	303895	650
Black	307695	650
Brass	307701	650



LED source 3000 K,
50.000 h life.

3,100 Kg
0,1134 m³
LED 82W / 10000 lm



ON-OFF

FINISH	CODE	€
White	247274	430
Black	247281	430
Brass	269849	430

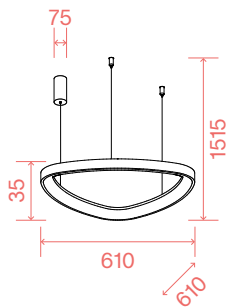
DALI/PUSH

FINISH	CODE	€
White	304748	525
Black	304724	525
Brass	304731	525

2,060 Kg
0,0774 m³
LED 55W / 6600 lm



LED source 3000 K,
50.000 h life.



ON-OFF

FINISH	CODE	€
White	247250	330
Black	247267	330
Brass	269832	330

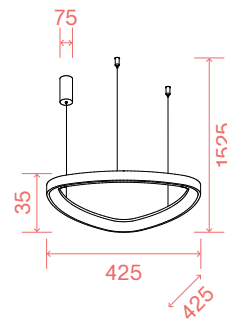
DALI/PUSH

FINISH	CODE	€
White	304717	425
Black	304694	425
Brass	304700	425

1,710 Kg
0,0462 m³
LED 48W / 6600 lm



LED source 3000 K,
50.000 h life.



ON-OFF

FINISH	CODE	€
White	247229	240
Black	247236	240
Brass	247243	240



LED source 3000 K,
50.000 h life.

1,290 Kg
0,0230 m³
LED 38W / 5100 lm

GEMINI

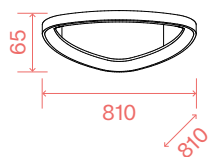
WALL / CEILING



ON-OFF



DALI/PUSH IP20



ON-OFF

FINISH	CODE	€
White	328072	390
Black	328089	390
Brass	328096	390

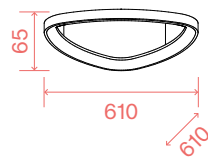
4,800 Kg
0,0919 m³
LED 41W / 5700 lm

DALI/PUSH

FINISH	CODE	€
White	328973	480
Black	328980	480
Brass	329260	480



LED source 3000 K,
30.000 h life.



ON-OFF

FINISH	CODE	€
White	328041	300
Black	328058	300
Brass	328065	300

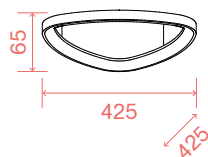
3,200 Kg
0,0507 m³
LED 27W / 3850 lm

DALI/PUSH

FINISH	CODE	€
White	328942	380
Black	328959	380
Brass	328966	380



LED source 3000 K,
30.000 h life.



ON-OFF

FINISH	CODE	€
White	328010	220
Black	328027	220
Brass	328034	220

1,900 Kg
0,0271 m³
LED 23W / 3200 lm



LED source 3000 K,
30.000 h life.



LOOK

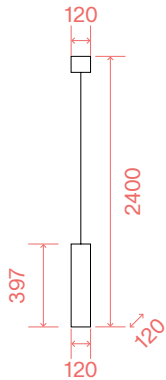
SPOTLIGHT



IP20



PHOTO p. 44



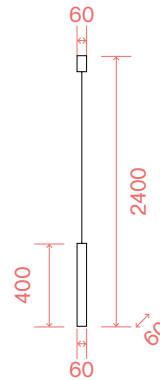
(RECOMMENDED)

LUMEN	CCT	CODE	€
800 lm	3000 K	189031	15

FINISH	CODE	€
Black	158723	132

Bulbs LED GU10 10W 3000 K included. Cod. 189031

2,950 Kg
0,0092 m³
GU10 max 1 x 50W



(RECOMMENDED)

LUMEN	CCT	CODE	€
540 lm	3000 K	123943	3,50

FINISH	CODE	€
White	104935	72
Chrome	104942	72
Black	104928	72
Clear	194806	95
Silver	141800	95
Nickel	313894	95
Gold	141817	95
Brass	259239	95
Antique Brass	141794	95
Copper	141855	95
Coffee	170589	95

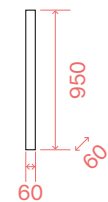
Bulbs LED GU10 7W 3000 K included. Cod. 123943

0,990 Kg
0,0029 m³
GU10 max 1 x 28W

CEILING



IP20



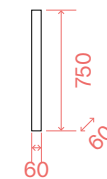
(RECOMMENDED)

LUMEN	CCT	CODE	€
540 lm	3000 K	123943	3,50

FINISH	CODE	€
White	259260	86
Black	259277	86

Bulbs LED GU10 7W 3000 K included. Cod. 123943

3,070 Kg
0,0061 m³
GU10 max 1 x 28W



(RECOMMENDED)

LUMEN	CCT	CODE	€
540 lm	3000 K	123943	3,50

FINISH	CODE	€
White	233352	60
Black	233321	60

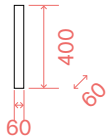
Bulbs LED GU10 7W 3000 K included. Cod. 123943

1,380 Kg
0,0037 m³
GU10 max 1 x 28W

CEILING



IP20



0,740 Kg
0,0025 m³
GU10 max 1 x 28W

(RECOMMENDED)

LUMEN	CCT	CODE	€
540 lm	3000 K	123943	3,50

FINISH	CODE	€
White	233215	48
Black	233192	48

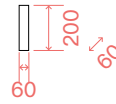
Bulbs LED GU10 7W 3000 K included. Cod. 123943

(RECOMMENDED)

LUMEN	CCT	CODE	€
540 lm	3000 K	123943	3,50

FINISH	CODE	€
White	233079	38
Black	285214	38
Brass	233062	38

Bulbs LED GU10 7W 3000 K included. Cod. 123943

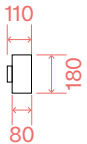


0,400 Kg
0,0013 m³
GU10 max 1 x 28W

WALL



IP20



0,500 Kg
0,0028 m³
GU10 max 2 x 28W

(RECOMMENDED)

LUMEN	CCT	CODE	€
540 lm	3000 K	123943	3,50

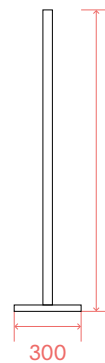
FINISH	CODE	€
White	096018	80
Chrome	094182	80
Black	095998	80
Copper	164847	80
Antique Brass	164823	80

Bulbs LED GU10 7W 3000 K included. Cod. 123943

FLOOR



IP20



5,080 Kg
0,0809 m³
LED 24W / 2950 lm

FINISH	CODE	€
White	304922	240
Black	304915	240

LED source 3000 K, 30.000 h life.

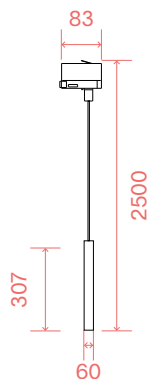


LOOK

TRACK MOUNTED



IP20



(RECOMMENDED)

LUMEN	CCT	CODE	€
540 lm	3000 K	123943	3,50

FINISH	CODE	€
White	231662	83
Black	231631	83

Bulbs LED GU10 7W 3000 K included. Cod. 123943

SINGLE CONNECTION

REQUIRED	DRIVER
no	on/off

FINISH	CODE	€
White	170145	27
Black	170152	27

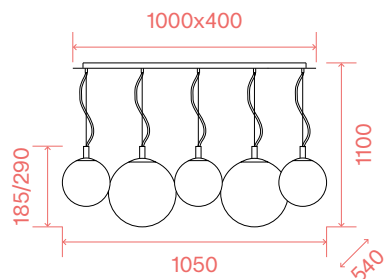
0,930 Kg
0,0037 m³
GU10 max 1 x 28W

MAPA BIANCO

SUSPENSION



IP20



(RECOMMENDED)

LUMEN	CCT	CODE	€
910 lm	3000 K	119571	6

FINISH	CODE	€
White	043562	530

8,700 Kg
0,2470 m³
E27 max 5 x 60W

MAPA BIANCO

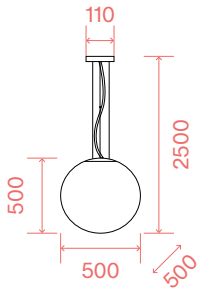
SUSPENSION



IP20



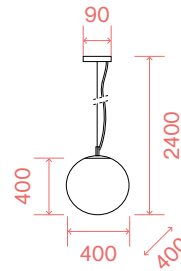
PHOTO p. 52



(RECOMMENDED)

LUMEN	CCT	CODE	€
910 lm	3000 K	119571	6
FINISH		CODE	€
White		032122	303

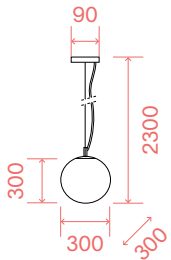
5,390 Kg
0,2254 m³
E27 max 1 x 60W



(RECOMMENDED)

LUMEN	CCT	CODE	€
910 lm	3000 K	119571	6
FINISH		CODE	€
White		032139	145

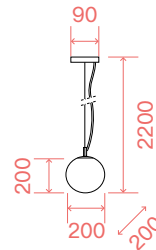
3,620 Kg
0,1215 m³
E27 max 1 x 60W



(RECOMMENDED)

LUMEN	CCT	CODE	€
910 lm	3000 K	119571	6
FINISH		CODE	€
White		009087	78

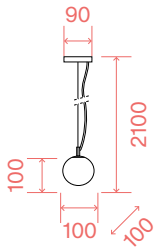
1,920 Kg
0,0630 m³
E27 max 1 x 60W



(RECOMMENDED)

LUMEN	CCT	CODE	€
910 lm	3000 K	119571	6
FINISH		CODE	€
White		009148	52

1,130 Kg
0,0272 m³
E27 max 1 x 60W



(RECOMMENDED)

LUMEN	CCT	CODE	€
510 lm	3000 K	305486	6
FINISH		CODE	€
White		310800	50

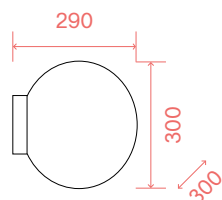
0,041 Kg
0,0027 m³
G9 max 1 x 4W



Bulbs LED G9 4W 3000 K
Cod. 209043

MAPA BIANCO

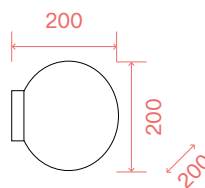
WALL/CEILING



(RECOMMENDED)

LUMEN	CCT	CODE	€
430 lm	3000 K	101279	2,60
FINISH		CODE	€
White		059822	88

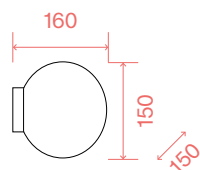
1,660 Kg
0,0647 m³
E27 max 1 x 60W



(RECOMMENDED)

LUMEN	CCT	CODE	€
430 lm	3000 K	101279	2,60
FINISH		CODE	€
White		059815	50

0,900 Kg
0,0259 m³
E27 max 1 x 60W

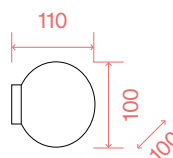


(RECOMMENDED)

LUMEN	CCT	CODE	€
510 lm	3000 K	305486	6
FINISH		CODE	€
White		059808	44

0,380 Kg
0,0115 m³
G9 max 1 x 15W

Bulbs LED G9 4W 3000 K
Cod. 209043



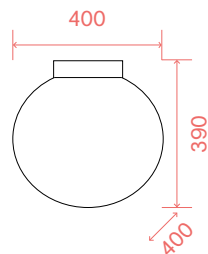
(RECOMMENDED)

LUMEN	CCT	CODE	€
510 lm	3000 K	305486	6
FINISH		CODE	€
White		310787	35

0,230 Kg
0,0025 m³
G9 max 1 x 4W

Bulbs LED G9 4W 3000 K
Cod. 209043

CEILING



(RECOMMENDED)

LUMEN	CCT	CODE	€
910 lm	3000 K	119571	6
FINISH		CODE	€
White		059839	188

2,590 Kg
0,1290 m³
E27 max 1 x 60W

MAPA BIANCO

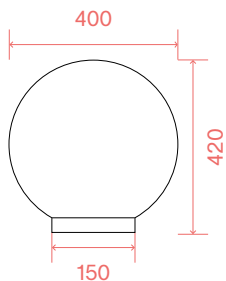
TABLE



IP20



PHOTO p. 204



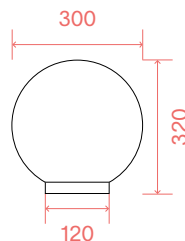
(RECOMMENDED)

LUMEN	CCT	CODE	€
910 lm	3000 K	119571	6

FINISH	CODE	€
White	000206	165



3,520 Kg
0,1354 m³
E27 max 1 x 60W



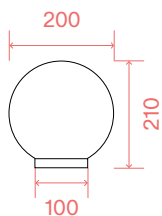
(RECOMMENDED)

LUMEN	CCT	CODE	€
910 lm	3000 K	119571	6

FINISH	CODE	€
White	009131	85



1,880 Kg
0,0515 m³
E27 max 1 x 60W



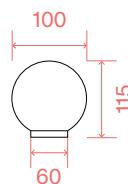
(RECOMMENDED)

LUMEN	CCT	CODE	€
910 lm	3000 K	119571	6

FINISH	CODE	€
White	009155	50



1,050 Kg
0,0214 m³
E27 max 1 x 60W



(RECOMMENDED)

LUMEN	CCT	CODE	€
510 lm	3000 K	305486	6

FINISH	CODE	€
White	310817	45



Bulbs LED G9 4W 3000 K
Cod. 209043



0,280 Kg
0,0026 m³
G9 max 1 x 4W

MINT

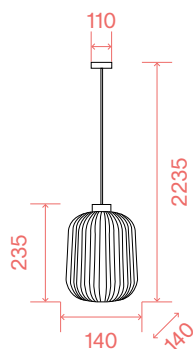
SUSPENSION



IP20



PHOTO p. 58

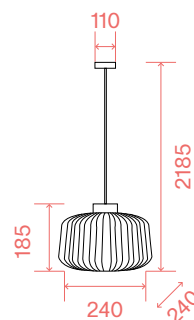


(RECOMMENDED)

LUMEN	CCT	CODE	€
910 lm	3000 K	119571	6

FINISH	CODE	€
Smoky Grey	237442	105
Verde	248554	105

1,350 Kg
0,0147 m³
E27 max 1 x 60W

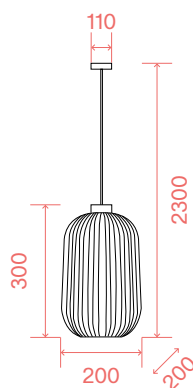


(RECOMMENDED)

LUMEN	CCT	CODE	€
910 lm	3000 K	119571	6

FINISH	CODE	€
Smoky Grey	237398	127
Verde	237428	127

1,560 Kg
0,0532 m³
E27 max 1 x 60W



(RECOMMENDED)

LUMEN	CCT	CODE	€
910 lm	3000 K	119571	6

FINISH	CODE	€
Smoky Grey	237510	138
Verde	237497	138

1,80 Kg
0,0269 m³
E27 max 1 x 60W

MIX UP

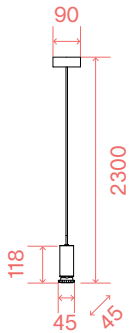
SUSPENSION



IP20



PHOTO p. 62



(RECOMMENDED)

LUMEN	CCT	CODE	€
900 lm	3000 K	123899	6

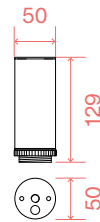
FINISH	CODE	€
White	288406	55
Black	288390	55

0,460 Kg
0,0018 m³
E27 max 1 x 60W

CEILING



IP20



(RECOMMENDED)

LUMEN	CCT	CODE	€
900 lm	3000 K	123899	6

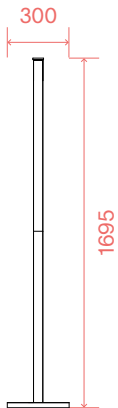
FINISH	CODE	€
White	292847	35
Black	292830	35

0,270 Kg
0,0005 m³
E27 max 1 x 60W

FLOOR



IP20



(RECOMMENDED)

LUMEN	CCT	CODE	€
900 lm	3000 K	123899	6

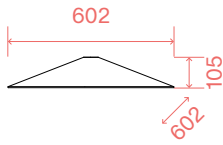
FINISH	CODE	€
White	328164	200
Black	328171	200



8,500 Kg
0,0326 m³
E27 max 1 x 42W

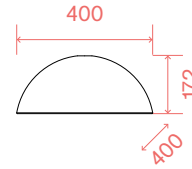
MIX UP

SHADE OPTIONS



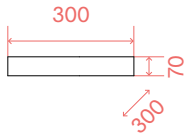
FINISH	CODE	€
White	288437	85
Black	288420	85

2,000 Kg
0,0676 m³



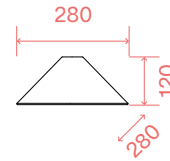
FINISH	CODE	€
White	307404	55
Black	288475	55

1,100 Kg
0,0446 m³



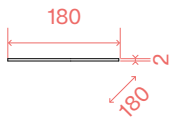
FINISH	CODE	€
White	307411	40
Black	288444	40

0,800 Kg
0,0147 m³



FINISH	CODE	€
White	307428	35
Black	288451	35

0,500 Kg
0,0174 m³



FINISH	CODE	€
White	307435	20
Black	288482	20

0,340 Kg
0,0008 m³

MOBY

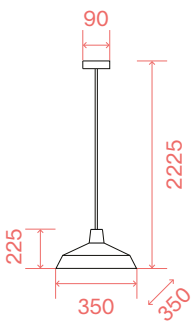
SUSPENSION



IP20



PHOTO p. 74



(RECOMMENDED)

LUMEN	CCT	CODE	€
950 lm	3000 K	101330	7,50

FINISH	CODE	€
White	102047	127
Black	093659	127
Copper	093697	127

1,200 Kg
0,0356 m³
E27 max 1 x 42W

NEMO

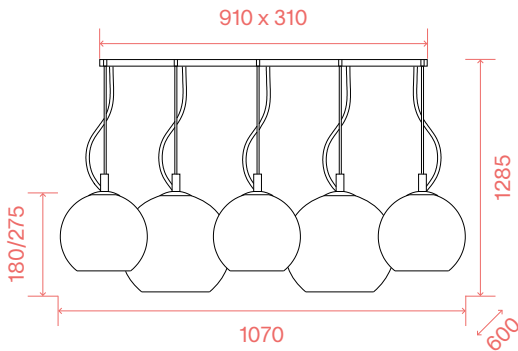
SUSPENSION



IP20



PHOTO p. 80

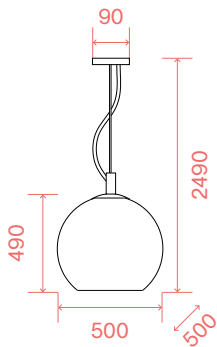


8,700 Kg
0,2424 m³
E27 max 5 x 60W

(RECOMMENDED)

LUMEN	CCT	CODE	€
910 lm	3000 K	119571	6

FINISH	CODE	€
Fade Chrome	138305	650

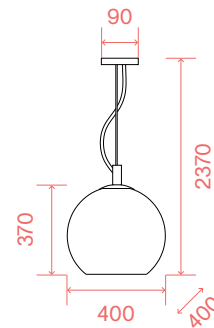


(RECOMMENDED)

LUMEN	CCT	CODE	€
1050 lm	3000 K	101347	8

FINISH	CODE	€
Smoky Grey	094137	450

4,000 Kg
0,2220 m³
E27 max 1 x 60W

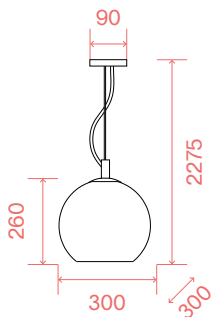


(RECOMMENDED)

LUMEN	CCT	CODE	€
1050 lm	3000 K	101347	8

FINISH	CODE	€
Clear	052816	250
Fade Chrome	250359	250
Smoky Grey	094229	250
Chrome	250342	250
Copper	111919	250

2,700 Kg
0,1227 m³
E27 max 1 x 60W

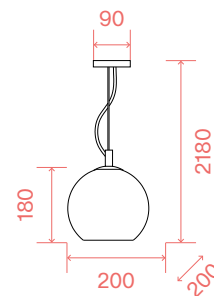


(RECOMMENDED)

LUMEN	CCT	CODE	€
1050 lm	3000 K	101323	7

FINISH	CODE	€
Clear	052809	165
Fade Chrome	149592	165
Smoky Grey	094236	165
Chrome	250335	165
Copper	111902	165

2,050 Kg
0,0664 m³
E27 max 1 x 60W



(RECOMMENDED)

LUMEN	CCT	CODE	€
1050 lm	3000 K	101323	7

FINISH	CODE	€
Fade Chrome	149585	80
Smoky Grey	250311	80
Chrome	250304	80
Copper	250328	80

1,300 Kg
0,0241 m³
E27 max 1 x 60W

ONION

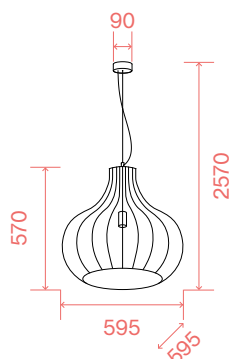
SUSPENSION



IP20



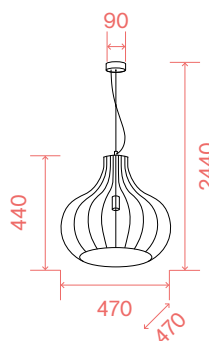
PHOTO p. 86



(RECOMMENDED)

LUMEN	CCT	CODE	€
480 lm	2200 K	151724	8
FINISH		CODE	€
Coffee		205311	400

5,050 Kg
0,2383 m³
E27 max 1 x 60W



(RECOMMENDED)

LUMEN	CCT	CODE	€
480 lm	2200 K	151724	8
FINISH		CODE	€
Coffee		205304	270

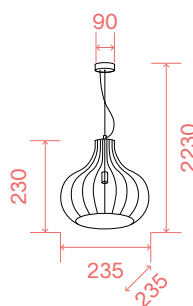
3,520 Kg
0,1325 m³
E27 max 1 x 60W



(RECOMMENDED)

LUMEN	CCT	CODE	€
500 lm	2200 K	151717	8
FINISH		CODE	€
Coffee		205298	180

2,380 Kg
0,0705 m³
E27 max 1 x 60W



(RECOMMENDED)

LUMEN	CCT	CODE	€
500 lm	2200 K	151717	8
FINISH		CODE	€
Coffee		205281	95

1,260 Kg
0,0169 m³
E27 max 1 x 60W

ORACLE SLIM

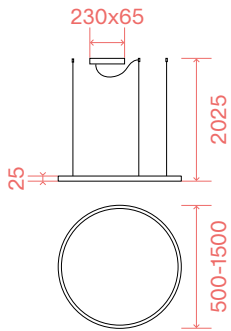
SUSPENSION



IP20 LED LIFE: 20.000 h



PHOTO p. 94



Cable length
2500 mm

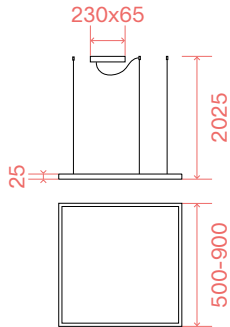
LED SMD (DRIVER INCLUDED)

MEASURE	WEIGHT	VOLUME	POWER	DRIVER	LUMEN	CCT	FINISH	CODE	€
ø 500	1,400 Kg	0,0376 m ³	32 W	On-Off	3150 lm	3000 K	White	229461	200
ø 500	1,400 Kg	0,0376 m ³	32 W	On-Off	3150 lm	3000 K	Black	229492	200
ø 500	1,400 Kg	0,0376 m ³	32 W	On-Off	3350 lm	4000 K	White	269856	200
ø 500	1,400 Kg	0,0376 m ³	32 W	On-Off	3350 lm	4000 K	Black	304380	200
ø 500	1,100 Kg	0,0272 m ³	29 W	DALI/Push	3000 lm	3000 K	White	304373	250
ø 500	1,100 Kg	0,0272 m ³	29 W	DALI/Push	3000 lm	3000 K	Black	304366	250
ø 700	1,660 Kg	0,0809 m ³	38 W	On-Off	4300 lm	3000 K	White	229485	245
ø 700	1,660 Kg	0,0809 m ³	38 W	On-Off	4300 lm	3000 K	Black	229515	245
ø 700	1,660 Kg	0,0809 m ³	38 W	On-Off	4500 lm	4000 K	White	269863	245
ø 700	1,660 Kg	0,0809 m ³	38 W	On-Off	4500 lm	4000 K	Black	304410	245
ø 700	1,200 Kg	0,0534 m ³	39 W	DALI/Push	4150 lm	3000 K	White	304403	300
ø 700	1,200 Kg	0,0534 m ³	39 W	DALI/Push	4150 lm	3000 K	Black	304397	300
ø 900	1,800 Kg	0,2212 m ³	55 W	On-Off	5400 lm	3000 K	White	229478	300
ø 900	1,800 Kg	0,2212 m ³	55 W	On-Off	5400 lm	3000 K	Black	229508	300
ø 900	1,800 Kg	0,2212 m ³	55 W	On-Off	5700 lm	4000 K	White	269870	300
ø 900	1,800 Kg	0,2212 m ³	55 W	On-Off	5700 lm	4000 K	Black	304441	300
ø 900	1,500 Kg	0,0857 m ³	43 W	DALI/Push	4600 lm	3000 K	White	304434	360
ø 900	1,500 Kg	0,0857 m ³	43 W	DALI/Push	4600 lm	3000 K	Black	304427	360
ø 1500	2,480 Kg	0,3072 m ³	89 W	On-Off	9000 lm	3000 K	White	265957	490
ø 1500	2,480 Kg	0,3072 m ³	89 W	On-Off	9000 lm	3000 K	Black	285061	490
ø 1500	2,480 Kg	0,3072 m ³	89 W	On-Off	9650 lm	4000 K	White	285078	490
ø 1500	2,480 Kg	0,3072 m ³	89 W	On-Off	9650 lm	4000 K	Black	304472	490
ø 1500	2,000 Kg	0,3072 m ³	76 W	DALI/Push	7050 lm	3000 K	White	304465	600
ø 1500	2,000 Kg	0,3072 m ³	76 W	DALI/Push	7050 lm	3000 K	Black	304458	600

ORACLE SLIM

SUSPENSION

 IP20 LED LIFE: 20.000 h



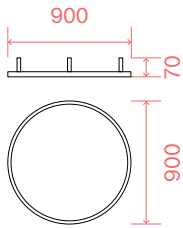
LED SMD (DRIVER ON/OFF INCLUDED)

MEASURE	WEIGHT	VOLUME	POWER	DRIVER	LUMEN	CCT	FINISH	CODE	€
500 x 500	1,730 Kg	0,0422 m ³	33 W	On-Off	3300 lm	3000 K	White	259154	210
500 x 500	1,730 Kg	0,0422 m ³	33 W	On-Off	3300 lm	3000 K	Black	259161	210
700 x 700	2,000 Kg	0,0819 m ³	41 W	On-Off	4350 lm	3000 K	White	259178	255
700 x 700	2,000 Kg	0,0819 m ³	41 W	On-Off	4350 lm	3000 K	Black	259185	255
900 x 900	2,100 Kg	0,1317 m ³	53 W	On-Off	5250 lm	3000 K	White	259192	310
900 x 900	2,100 Kg	0,1317 m ³	53 W	On-Off	5250 lm	3000 K	Black	259208	310


Cable length
2500 mm

CEILING

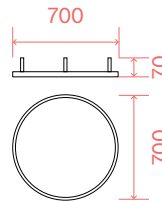
 IP20 LED LIFE: 20.000 h




FINISH	CODE	€
White	266015	295
Black	266022	295

 LED source 3000 K,
20.000 h life.

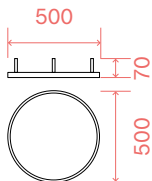
1,700 Kg
0,1345 m³
LED 55W / 5300 lm




FINISH	CODE	€
White	265995	240
Black	266008	240

 LED source 3000 K,
20.000 h life.

1,430 Kg
0,0852 m³
LED 38W / 4300 lm



FINISH	CODE	€
White	265971	195
Black	265988	195

 LED source 3000 K,
20.000 h life.

1,240 Kg
0,0455 m³
LED 32W / 3150 lm

OZ

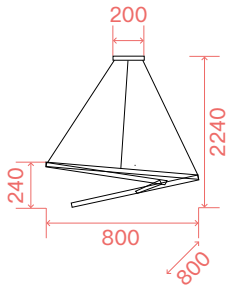
SUSPENSION



IP20



PHOTO p. 102



ON-OFF

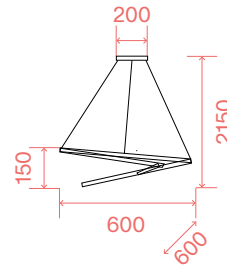
FINISH	CODE	€
White	253664	390
Black	269450	390
Brass	269467	390

DALI/PUSH

FINISH	CODE	€
White	304571	500
Black	304588	500
Brass	304595	500

1,900 Kg
0,0607 m³
LED 55W / 6100 lm

LED source 3000 K,
30.000 h life.



ON-OFF

FINISH	CODE	€
White	253671	325
Black	269436	325
Brass	269443	325

DALI/PUSH

FINISH	CODE	€
White	304540	415
Black	304557	415
Brass	304564	415

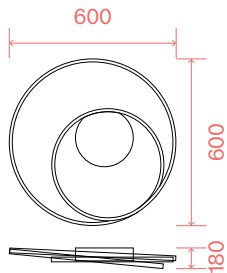
1,500 Kg
0,0354 m³
LED 48W / 5300 lm

LED source 3000 K,
30.000 h life.

CEILING



IP20



ON-OFF

FINISH	CODE	€
White	253688	320
Black	269412	320
Brass	269429	320

DALI/PUSH

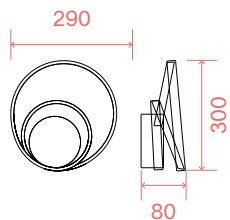
FINISH	CODE	€
White	304519	395
Black	304526	395
Brass	304533	395

1,500 Kg
0,0354 m³
LED 48W / 5200 lm

LED source 3000 K,
30.000 h life.

OZ

WALL



ON-OFF

FINISH	CODE	€
White	253695	190
Black	269399	190
Brass	269405	190

DALI/PUSH

FINISH	CODE	€
White	304489	255
Black	304496	255
Brass	304502	255

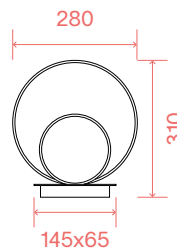
0,800 Kg
0,0087 m³
LED 28W / 2500 lm

LED source 3000 K,
30.000 h life.

TABLE



↑ PHOTO p. 210



ON-OFF

FINISH	CODE	€
White	269474	190
Black	269481	190
Brass	269498	190

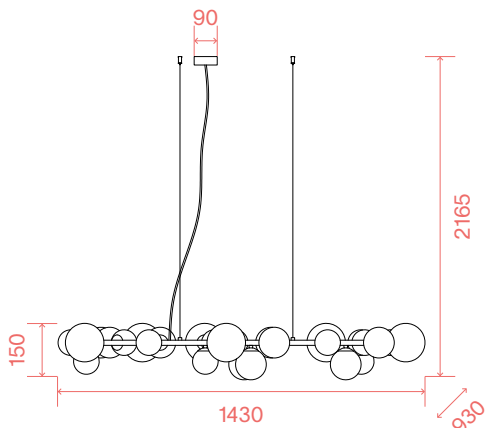
0,890 Kg
0,0096 m³
LED 23W / 2300 lm

LED source 3000 K,
30.000 h life.



PERLAGE

SUSPENSION



8,920 Kg
0,2722 m³
G9 max 30 x 15W

(RECOMMENDED)

LUMEN	CCT	CODE	€
510 lm	3000 K	305486	6

FINISH	CODE	€
White	296746	1400
Smoky Grey	296753	1400
Amber	322780	1400

Bulbs LED G9 4W 3000 K
included. Cod. 209043

PERLAGE

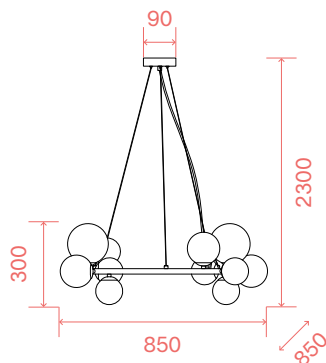
SUSPENSION



IP20



PHOTO p. 108



3,910 Kg
0,0924 m³
G9 max 14 x 15W

(RECOMMENDED)

LUMEN	CCT	CODE	€
510 lm	3000 K	305486	6

FINISH	CODE	€
White	283814	620
Smoky Grey	271385	620
Amber	322797	620

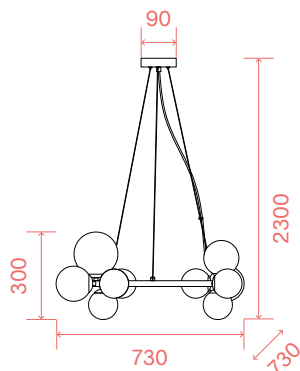


Bulbs LED G9 4W 3000 K
included. Cod. 209043

SUSPENSION



IP20



3,100 Kg
0,0736 m³
G9 max 11 x 15W

(RECOMMENDED)

LUMEN	CCT	CODE	€
510 lm	3000 K	305486	6

FINISH	CODE	€
White	283807	530
Smoky Grey	271392	530
Amber	322773	530



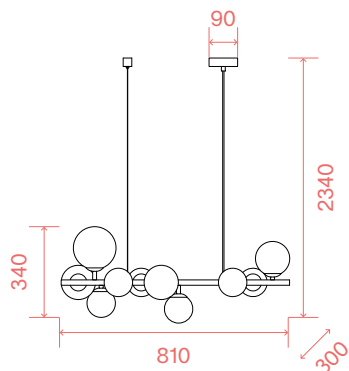
Bulbs LED G9 4W 3000 K
included. Cod. 209043

PERLAGE

SUSPENSION



IP20



2,200 Kg
0,0617 m³
G9 max 10 x 15W

(RECOMMENDED)

LUMEN	CCT	CODE	€
510 lm	3000 K	305486	6

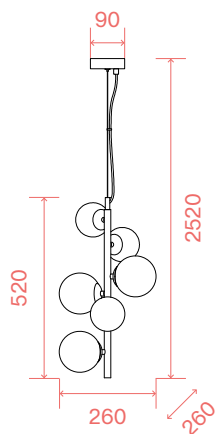
FINISH	CODE	€
White	283791	390
Smoky Grey	271408	390
Amber	322766	390

Bulbs LED G9 4W 3000 K included. Cod. 209043

SUSPENSION



IP20



1,300 Kg
0,0317 m³
G9 max 6 x 15W

(RECOMMENDED)

LUMEN	CCT	CODE	€
510 lm	3000 K	305486	6

FINISH	CODE	€
White	283821	260
Smoky Grey	271422	260
Amber	317793	260

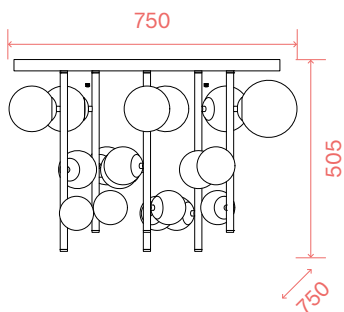
Bulbs LED G9 4W 3000 K included. Cod. 209043

PERLAGE

CEILING



IP20



7,520 Kg
0,1314 m³
G9 max 18 x 15W

(RECOMMENDED)

LUMEN	CCT	CODE	€
510 lm	3000 K	305486	6

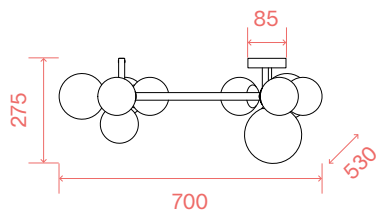
FINISH	CODE	€
White	328393	740
Smoky Grey	328386	740
Amber	328379	740

Bulbs LED G9 4W 3000 K included. Cod. 209043

CEILING



IP20



2,780 Kg
0,0605 m³
G9 max 10 x 15W

(RECOMMENDED)

LUMEN	CCT	CODE	€
510 lm	3000 K	305486	6

FINISH	CODE	€
White	327815	450
Smoky Grey	309286	450
Amber	327808	450

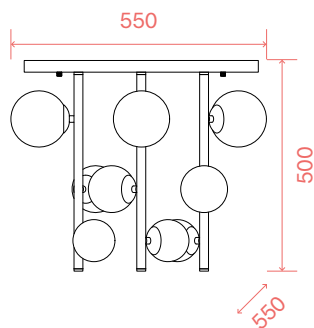
Bulbs LED G9 4W 3000 K included. Cod. 209043

PERLAGE

CEILING



IP20



3,870 Kg
0,0622 m³
G9 max 9 x 15W

(RECOMMENDED)

LUMEN	CCT	CODE	€
510 lm	3000 K	305486	6

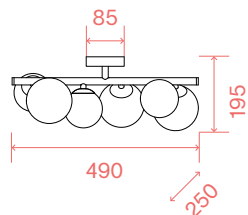
FINISH	CODE	€
White	328423	380
Smoky Grey	328416	380
Amber	328409	380

Bulbs LED G9 4W 3000 K included. Cod. 209043

CEILING



IP20



1,550 Kg
0,0385 m³
G9 max 6 x 15W

(RECOMMENDED)

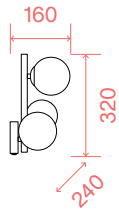
LUMEN	CCT	CODE	€
510 lm	3000 K	305486	6

FINISH	CODE	€
White	309279	230
Smoky Grey	309262	230
Amber	327822	230

Bulbs LED G9 4W 3000 K included. Cod. 209043

PERLAGE

WALL



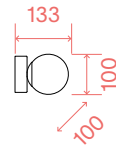
0,800 Kg
0,0173 m³
G9 max 3 x 15W

(RECOMMENDED)

LUMEN	CCT	CODE	€
510 lm	3000 K	305486	6

FINISH	CODE	€
White	283784	150
Smoky Grey	271439	150
Amber	322742	150

Bulbs LED G9 4W 3000 K included. Cod. 209043



0,400 Kg
0,0062 m³
G9 max 1 x 15W

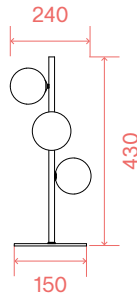
(RECOMMENDED)

LUMEN	CCT	CODE	€
510 lm	3000 K	305486	6

FINISH	CODE	€
White	292410	65
Smoky Grey	292403	65
Amber	317809	65

Bulbs LED G9 4W 3000 K included. Cod. 209043

TABLE



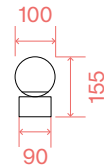
2,000 Kg
0,0227 m³
G9 max 3 x 15W

(RECOMMENDED)

LUMEN	CCT	CODE	€
510 lm	3000 K	305486	6

FINISH	CODE	€
White	292472	175
Smoky Grey	292465	175
Amber	322759	175

Bulbs LED G9 4W 3000 K included. Cod. 209043



0,600 Kg
0,0062 m³
G9 max 1 x 15W

(RECOMMENDED)

LUMEN	CCT	CODE	€
510 lm	3000 K	305486	6

FINISH	CODE	€
White	292458	75
Smoky Grey	292441	75
Amber	317823	75

Bulbs LED G9 4W 3000 K included. Cod. 209043



PERLAGE

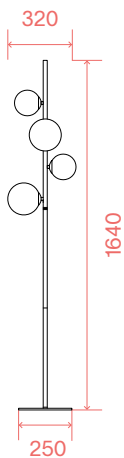
FLOOR



IP20




PHOTO p. 270



(RECOMMENDED)

LUMEN	CCT	CODE	€
510 lm	3000 K	305486	6

FINISH	CODE	€
White	277967	285
Smoky Grey	306988	285
Amber	317816	285

 Bulbs LED G9 4W 3000 K included. Cod. 209043



4,800 Kg
0,0612 m³
G9 max 4 x 15W

PIANO

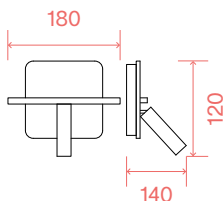
WALL




IP20



PHOTO p. 182



FINISH	CODE	€
White	287317	165
Black	287300	165

 LED source 3000 K, 20.000 h life.

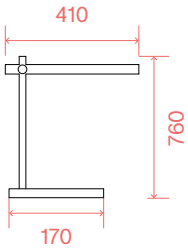


0,800 Kg
0,0047 m³
LED 11,5W / 1200 lm

PIVOT


TABLE

IP20  PHOTO p. 218



0,700 Kg
0,0135 m³
LED 7,5W / 700 lm

FINISH	CODE	€
White	289168	75
Black	289151	75

 LED source. Settable
CCT: 3000, 4000, 6000 K.
25.000 h life.



SET UP

SUSPENSION

IP20



0,350 Kg
0,0019 m³
E27 max 1 x 60W

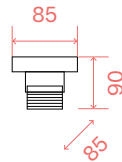
(RECOMMENDED)

LUMEN	CCT	CODE	€
900 lm	3000 K	123899	6

FINISH	CODE	€
White	260013	29
Nickel	260044	29
Black	260020	29
Brass	260051	29

CEILING

IP20



0,300 Kg
0,0010 m³
E27 max 1 x 60W

(RECOMMENDED)

LUMEN	CCT	CODE	€
900 lm	3000 K	123899	6

FINISH	CODE	€
White	277288	35

SET UP

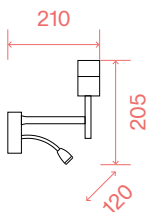
WALL



IP20



PHOTO p. 186



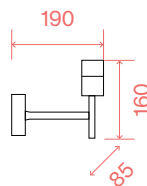
0,900 Kg
0,0063 m³
E27 max 1 x 60W +
LED 3W / 200 lm

(RECOMMENDED)

LUMEN	CCT	CODE	€
900 lm	3000 K	123899	6

FINISH	CODE	€
White	259819	115
Nickel	259833	115
Black	259826	115
Brass	259857	115

LED source 3000 K
20.000 h life.



0,370 Kg
0,0032 m³
E27 max 1 x 60W

(RECOMMENDED)

LUMEN	CCT	CODE	€
900 lm	3000 K	123899	6

FINISH	CODE	€
White	259765	55
Nickel	259796	55
Black	259772	55
Brass	259802	55

SET UP

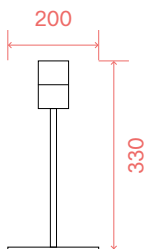
TABLE



IP20



PHOTO p. 224

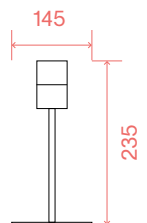


1,130 Kg
0,0055 m³
E27 max 1 x 60W

(RECOMMENDED)

LUMEN	CCT	CODE	€
900 lm	3000 K	123899	6

FINISH	CODE	€
White	259918	78
Nickel	259949	78
Black	259925	78
Brass	259956	78



0,680 Kg
0,0061 m³
E27 max 1 x 60W

(RECOMMENDED)

LUMEN	CCT	CODE	€
900 lm	3000 K	123899	6

FINISH	CODE	€
White	259864	61
Nickel	259895	61
Black	259871	61
Brass	259901	61



SET UP

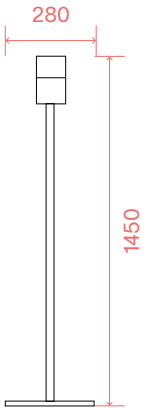
FLOOR



IP20



PHOTO p. 276



(RECOMMENDED)

LUMEN	CCT	CODE	€
900 lm	3000 K	123899	6

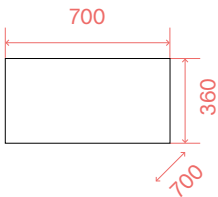
FINISH	CODE	€
White	259963	145
Nickel	259994	145
Black	259970	145
Brass	260006	145



2,640 Kg
0,0251 m³
E27 max 1 x 60W

SET UP

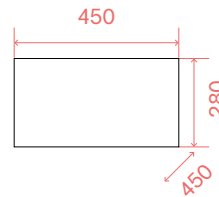
SHADE OPTIONS



(COMPATIBLE WITH SUSPENSION AND CEILING VERSIONS)

FINISH	CODE	€
White	260471	116
Dove Grey	304632	116
Black	270029	116
Beige	260488	116

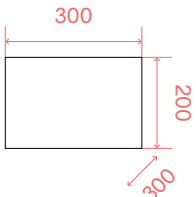
1,260 Kg
0,2131 m³



(COMPATIBLE WITH SUSPENSION, CEILING AND FLOOR VERSIONS)

FINISH	CODE	€
White	260457	85
Dove Grey	304625	85
Black	270012	85
Beige	260464	85

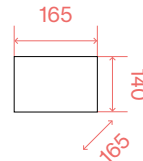
0,470 Kg
0,0221 m³



(COMPATIBLE WITH CEILING, WALL AND TABLE VERSIONS)

FINISH	CODE	€
White	260433	55
Dove Grey	304618	55
Black	270005	55
Beige	260440	55

0,230 Kg
0,0238 m³



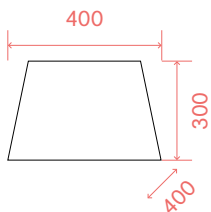
(COMPATIBLE WITH WALL AND TABLE VERSIONS)

FINISH	CODE	€
White	260327	28
Dove Grey	304601	28
Black	269986	28
Beige	260334	28

0,012 Kg
0,0180 m³

SET UP

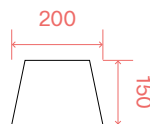
SHADE OPTIONS



(COMPATIBLE WITH FLOOR VERSIONS)

FINISH	CODE	€
White	260136	65
Dove Grey	304120	65
Black	260235	65
Beige	260242	65

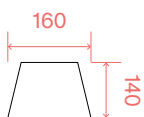
0,460 Kg
0,0709 m³



(COMPATIBLE WITH WALL AND TABLE VERSIONS)

FINISH	CODE	€
White	260068	29
Dove Grey	304113	29
Black	260075	29
Beige	260082	29

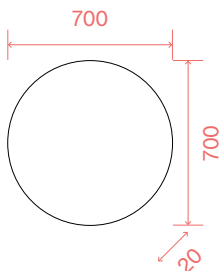
0,130 Kg
0,0180 m³



(COMPATIBLE WITH WALL AND TABLE VERSIONS)

FINISH	CODE	€
White	260341	25
Dove Grey	293004	25
Black	270036	25
Beige	260358	25

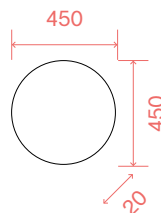
0,110 Kg
0,0180 m³



(COMPATIBLE WITH SUSPENSIONS AND CEILING VERSIONS)

FINISH	CODE	€
Clear	270050	50

0,700 Kg
0,0259 m³



(COMPATIBLE WITH SUSPENSIONS AND CEILING VERSIONS)

FINISH	CODE	€
Clear	270043	30

0,280 Kg
0,0108 m³

SPIKE

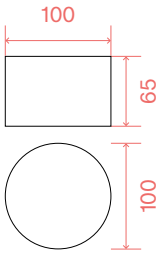
CEILING



IP20



PHOTO p. 146



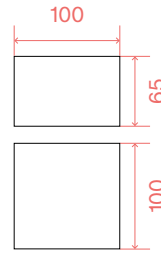
0,240 Kg
0,0017 m³
GX53 max 1 x 15W

(RECOMMENDED)

LUMEN	CCT	CODE	€
910 lm	3000 K	123936	5,50

FINISH	CODE	€
White	277417	80
Chrome	310886	80
Nickel	314303	80
Black	278704	80
Brass	285238	80
Copper	310893	80

Bulbs LED GX53 9W 3000 K included. Cod. 123936



0,220 Kg
0,0014 m³
GX53 max 1 x 15W

(RECOMMENDED)

LUMEN	CCT	CODE	€
910 lm	3000 K	123936	5,50

FINISH	CODE	€
White	317489	85
Chrome	328799	85
Nickel	328805	85
Black	317496	85
Brass	317502	85
Copper	328812	85

Bulbs LED GX53 9W 3000 K included. Cod. 123936

ULTRATHIN

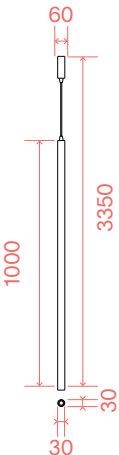
SUSPENSION



IP20



PHOTO p. 114



0,670 Kg
0,0036 m³
LED 11,5W / 1150 lm / 51°

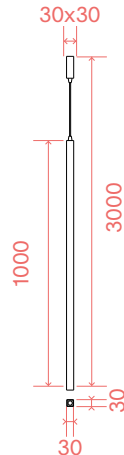
ON-OFF

FINISH	CODE	€
White	142906	130
Chrome	164878	130
Black	142913	130

DALI/PUSH

FINISH	CODE	€
Black	321783	185

LED source 3000 K, 20.000 h life.



0,860 Kg
0,0036 m³
LED 11,5W / 1150 lm / 51°

ON-OFF

FINISH	CODE	€
White	194172	190
Black	194196	190

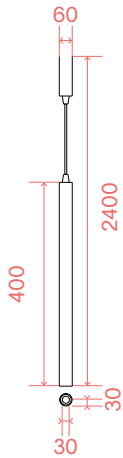
LED source 3000 K, 20.000 h life.

ULTRATHIN

SUSPENSION



IP20



ON-OFF

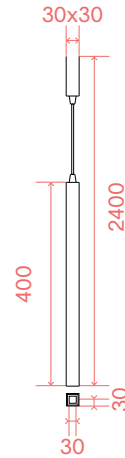
FINISH	CODE	€
White	156682	98
Chrome	187662	98
Black	156699	98

DALI/PUSH

FINISH	CODE	€
Black	321813	160

LED source 3000 K, 20.000 h life.

0,760 Kg
0,0037 m³
LED 11,5W / 1150 lm / 51°



ON-OFF

FINISH	CODE	€
White	194189	155
Black	194202	155

LED source 3000 K, 20.000 h life.

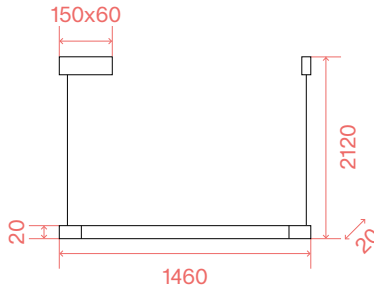
0,450 Kg
0,0019 m³
LED 11,5W / 1150 lm / 51°

YOKO

SUSPENSION



IP20



FINISH	CODE	€
White	258898	130
Black	258928	130

LED source 3000 K, 30.000 h life.

0,700 Kg
0,0383 m³
LED 16W / 1450 lm

YOKO

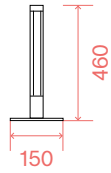
TABLE



IP20



PHOTO p. 230



0,860 Kg
0,247 m³
LED 5W / 410 lm

FINISH	CODE	€
White	258881	85
Black	258911	85

LED source 3000 K,
30.000 h life.



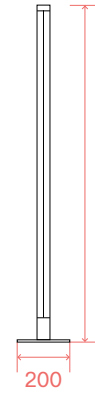
FLOOR



IP20



PHOTO p. 280



1,650 Kg
0,0534 m³
LED 16W / 1350 lm

FINISH	CODE	€
White	258874	135
Black	258904	135

LED source 3000 K,
30.000 h life.



ZIG ZAG

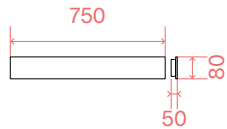
WALL



IP20



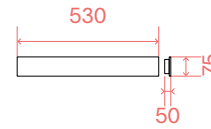
PHOTO p. 190



1,040 Kg
0,0047 m³
LED 30W
4100/4300 lm

FINISH	CCT	CODE	€
White	3000 K	277219	135
White	4000 K	277257	135
Chrome	3000 K	307183	135
Black	3000 K	277226	135
Brass	3000 K	287072	135
Copper	3000 K	307190	135

LED source 3000/4000 K,
50.000 h life.



0,760 Kg
0,0034 m³
LED 23W
2900/3050 lm

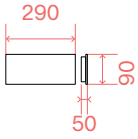
FINISH	CCT	CODE	€
White	3000 K	179308	103
White	4000 K	277240	103
Chrome	3000 K	282152	103
Black	3000 K	179322	103
Brass	3000 K	282138	103
Copper	3000 K	282176	103

LED source 3000/4000 K,
50.000 h life.

ZIG ZAG

WALL

⊕ IP20



0,450 Kg
0,0020 m³
LED 12,5W
1450/1550 lm

FINISH	CCT	CODE	€
White	3000 K	179292	90
White	4000 K	277233	90
Chrome	3000 K	282145	90
Black	3000 K	179315	90
Brass	3000 K	282121	90
Copper	3000 K	282169	90

Ⓛ LED LED source 3000/4000 K,
50.000 h life.

BENTO

RECESSED LIGHTS



IP20 MacAdam: SDCM 3 UGR: <19 CRI: ≥90 LED LIFE: 50.000 h



↑ PHOTO p. 352

	REQUIRED	BEAM	FINISH	CODE	€
LENS	No	18°	Clear	287942	4
LENS	No	45°	Clear	279626	4
FILTER HONEYCOMB	No		Black	279718	4
DIFFUSER	No		Black	279725	3
SNOOT	No		Black	279701	4
ANTI-GLARE RING	No		White	288147	3
ANTI-GLARE RING	No		Black	279695	3

LED COB CITIZEN (REQUIRED - DRIVER TRIDONIC ON/OFF INCLUDED)

POWER	BEAM	LUMEN	CCT	FINISH	CODE	€
9 W	36°	730 lm	3000 K	Black	279596	45

DIMMABLE DRIVER* (NOT INCLUDED/OPTIONAL)

	POWER	OUTPUT	MEASURE	CODE	€
1-10V	12 W	250 mA	122 x 25 x 40 mm	287843	58
DALI / Push	20 W	250 mA	120 x 29 x 51 mm	287850	87

*The dimmable power supplies must be ordered in concomitance with the product and will be included inside the fittings by replacing the on-off power supply.

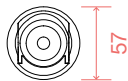
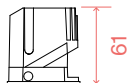
LED COB CITIZEN (REQUIRED - DRIVER TRIDONIC ON/OFF INCLUDED)

POWER	BEAM	LUMEN	CCT	FINISH	CODE	€
13 W	36°	1000 lm	3000 K	Black	279602	50

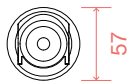
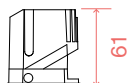
DIMMABLE DRIVER (NOT INCLUDED/OPTIONAL)

	POWER	OUTPUT	MEASURE	CODE	€
1-10V / Push	20 W	350 mA	108 x 22 x 52 mm	287867	75
DALI / Push	20 W	350 mA	120 x 29 x 51 mm	287874	80

*The dimmable power supplies must be ordered in concomitance with the product and will be included inside the fittings by replacing the on-off power supply.



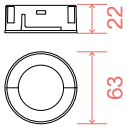
0,400 Kg
0,0030 m³



0,400 Kg
0,0030 m³

BENTO

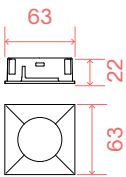
FRAME AND REFLECTOR



ROUND - REFLECTOR
(REQUIRED)

FINISH	CODE	€
White	279633	6
Black	279640	6

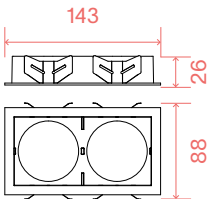
0,020 Kg
0,0001 m³



SQUARE - REFLECTOR
(REQUIRED)

FINISH	CODE	€
White	279671	8
Black	279688	8

0,020 Kg
0,0001 m³

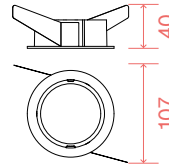


SQUARE - FRAME TWIN
(REQUIRED)

FINISH	CODE	€
White	287935	24
Black	280233	24

134x71

0,110 Kg
0,0004 m³

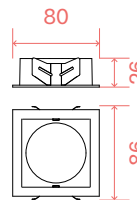


ROUND - FRAME SINGLE
(REQUIRED)

FINISH	CODE	€
White	287898	12
Black	287881	12

68

0,060 Kg
0,0007 m³

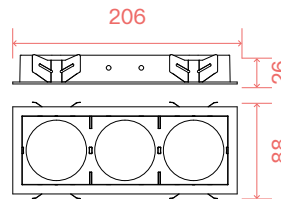


SQUARE - FRAME SINGLE
(REQUIRED)

FINISH	CODE	€
White	287911	14
Black	287904	14

68x68

0,050 Kg
0,0002 m³



SQUARE - FRAME TRIPLE
(REQUIRED)

FINISH	CODE	€
White	287928	30
Black	280240	30

197x71

0,300 Kg
0,0006 m³

DISPLAY ACCENT

PROJECTORS

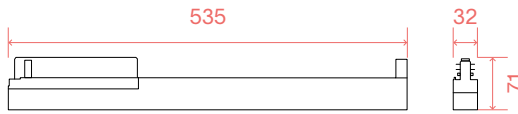


IP20 MacAdam: SDCM 3 UGR: <16 CRI: ≥80 LED LIFE: 50.000 h



↑ PHOTO p. 295

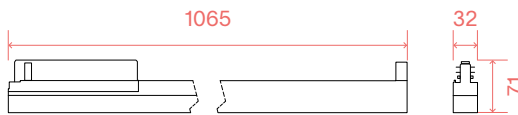
0,400 Kg
0,0064 m³



LED SMD SAMSUNG (DRIVER ON/OFF INCLUDED)

POWER	BEAM	LUMEN	CCT	FINISH	CODE	€
14 W	60°	1800 lm	3000 K	White	283593	210
14 W	60°	1800 lm	3000 K	Black	283609	210
14 W	60°	1900 lm	4000 K	White	283616	210
14 W	60°	1900 lm	4000 K	Black	283623	210

1,120 Kg
0,0112 m³



LED SMD SAMSUNG (DRIVER ON/OFF INCLUDED)

POWER	BEAM	LUMEN	CCT	FINISH	CODE	€
28 W	60°	3500 lm	3000 K	White	283524	330
28 W	60°	3500 lm	3000 K	Black	276267	330
28 W	60°	3700 lm	4000 K	White	283531	330
28 W	60°	3700 lm	4000 K	Black	283548	330

1,570 Kg
0,0173 m³



LED SMD SAMSUNG (DRIVER ON/OFF INCLUDED)

POWER	BEAM	LUMEN	CCT	FINISH	CODE	€
40 W	60°	5300 lm	3000 K	White	283555	455
40 W	60°	5300 lm	3000 K	Black	283562	455
40 W	60°	5600 lm	4000 K	White	283579	455
40 W	60°	5600 lm	4000 K	Black	283586	455

DISPLAY WIDE

PROJECTORS

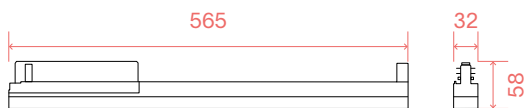


IP20 MacAdam: SDCM 3 CRI: ≥80 LED LIFE: 50.000 h



↑ PHOTO p. 288

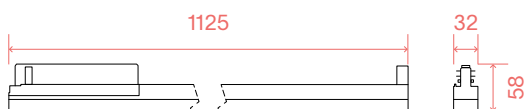
0,420 Kg
0,0067 m³



LED SMD SAMSUNG (DRIVER ON/OFF INCLUDED)

POWER	BEAM	LUMEN	CCT	FINISH	CODE	€
21 W	125°	2700 lm	3000 K	White	283753	175
21 W	125°	2700 lm	3000 K	Black	283760	175
21 W	125°	2850 lm	4000 K	White	276274	175
21 W	125°	2850 lm	4000 K	Black	283777	175

0,770 Kg
0,0124 m³



LED SMD SAMSUNG (DRIVER ON/OFF INCLUDED)

POWER	BEAM	LUMEN	CCT	FINISH	CODE	€
40 W	125°	5700 lm	3000 K	White	283722	265
40 W	125°	5700 lm	3000 K	Black	283050	265
40 W	125°	5850 lm	4000 K	White	283739	265
40 W	125°	5850 lm	4000 K	Black	283746	265

DISPLAY UGR

PROJECTORS

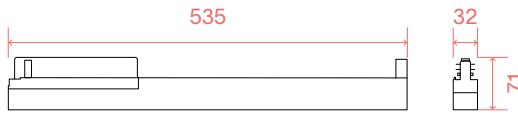


IP20 MacAdam: SDCM 3 UGR: <22 CRI: ≥80 LED LIFE: 50.000 h



↑ PHOTO p. 290

0,400 Kg
0,0064 m³



LED SMD SAMSUNG (DRIVER ON/OFF INCLUDED)

POWER	BEAM	LUMEN	CCT	FINISH	CODE	€
14 W	70°	2000 lm	3000 K	White	283685	185
14 W	70°	2000 lm	3000 K	Black	283692	185
14 W	70°	2100 lm	4000 K	White	283708	185
14 W	70°	2100 lm	4000 K	Black	283715	185

1,120 Kg
0,0112 m³



LED SMD SAMSUNG (DRIVER ON/OFF INCLUDED)

POWER	BEAM	LUMEN	CCT	FINISH	CODE	€
27 W	70°	4000 lm	3000 K	White	283647	290
27 W	70°	4000 lm	3000 K	Black	283630	290
27 W	70°	4300 lm	4000 K	White	276281	290
27 W	70°	4300 lm	4000 K	Black	283258	290

1,570 Kg
0,0173 m³



LED SMD SAMSUNG (DRIVER ON/OFF INCLUDED)

POWER	BEAM	LUMEN	CCT	FINISH	CODE	€
40 W	70°	6050 lm	3000 K	White	283654	410
40 W	70°	6050 lm	3000 K	Black	283067	410
40 W	70°	6450 lm	4000 K	White	283661	410
40 W	70°	6450 lm	4000 K	Black	283678	410

EGO TRACK SINGLE

SYSTEMS

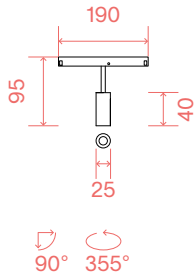


IP20 MacAdam: SDCM 3 CRI: ≥90 LED LIFE: 50.000 h



↑ PHOTO p. 298

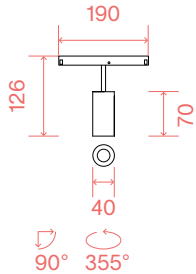
LED SMD OSRAM



0,080 Kg
0,0041 m³

POWER	BEAM	CONTROL	LUMEN	CCT	FINISH	CODE	€
3 W	30°	On-Off	200 lm	3000 K	White	282978	85
3 W	30°	On-Off	200 lm	3000 K	Black	257617	85
3 W	30°	On-Off	200 lm	3000 K	Brass	282039	85
3 W	30°	On-Off	220 lm	4000 K	Black	321912	85
3 W	30°	1-10V	200 lm	3000 K	White	303673	120
3 W	30°	1-10V	200 lm	3000 K	Black	303666	120
3 W	30°	DALI	200 lm	3000 K	White	286402	140
3 W	30°	DALI	200 lm	3000 K	Black	286396	140
3 W	30°	DALI	220 lm	4000 K	Black	317977	140

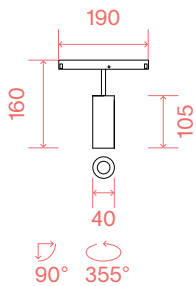
LED COB CITIZEN



0,150 Kg
0,0041 m³

POWER	BEAM	CONTROL	LUMEN	CCT	FINISH	CODE	€
8 W	30°	On-Off	850 lm	3000 K	White	282985	107
8 W	30°	On-Off	850 lm	3000 K	Black	257631	107
8 W	30°	On-Off	850 lm	3000 K	Brass	282046	107
8 W	30°	On-Off	900 lm	4000 K	Black	317984	107
8 W	30°	1-10V	850 lm	3000 K	White	303697	130
8 W	30°	1-10V	850 lm	3000 K	Black	303680	130
8 W	30°	DALI	850 lm	3000 K	White	286426	160
8 W	30°	DALI	850 lm	3000 K	Black	286419	160
8 W	30°	DALI	900 lm	4000 K	Black	321936	160

LED COB CITIZEN



0,190 Kg
0,0041 m³

POWER	BEAM	CONTROL	LUMEN	CCT	FINISH	CODE	€
12 W	30°	On-Off	1200 lm	3000 K	White	282992	115
12 W	30°	On-Off	1200 lm	3000 K	Black	257655	115
12 W	30°	On-Off	1200 lm	3000 K	Brass	282053	115
12 W	30°	On-Off	1250 lm	4000 K	Black	321967	115
12 W	30°	1-10V	1200 lm	3000 K	White	303710	135
12 W	30°	1-10V	1200 lm	3000 K	Black	303703	135
12 W	30°	DALI	1200 lm	3000 K	White	286440	165
12 W	30°	DALI	1200 lm	3000 K	Black	286433	165
12 W	30°	DALI	1250 lm	4000 K	Black	321943	165

FILTER HONEYCOMB

MODEL	REQUIRED	CODE	€
Ego 3 W	No	260853	5
Ego 8 W	No	260860	5
Ego 12 W	No	260860	5

EGO TRACK SINGLE

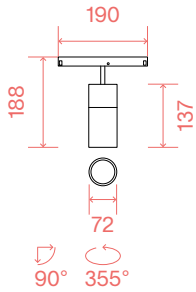
SYSTEMS



IP20 MacAdam: SDCM 3 CRI: ≥90 LED LIFE: 50.000 h



↑ PHOTO p. 298

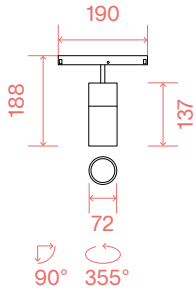


0,700 Kg
0,0035 m³

LED COB CITIZEN

POWER	BEAM	CONTROL	LUMEN	CCT	FINISH	CODE	€
19 W	35°	On-Off	2200 lm	3000 K	White	307558	175
19 W	35°	On-Off	2200 lm	3000 K	Black	305608	175
19 W	35°	On-Off	2350 lm	4000 K	Black	321998	175
19 W	35°	1-10V	2200 lm	3000 K	White	307527	195
19 W	35°	1-10V	2200 lm	3000 K	Black	307510	195
19 W	35°	DALI	2200 lm	3000 K	White	307541	230
19 W	35°	DALI	2200 lm	3000 K	Black	307534	230
19 W	35°	DALI	2350 lm	4000 K	Black	321974	230

LED COB CITIZEN



0,700 Kg
0,0035 m³

POWER	BEAM	CONTROL	LUMEN	CCT	FINISH	CODE	€
26 W	35°	On-Off	3050 lm	3000 K	White	307602	180
26 W	35°	On-Off	3050 lm	3000 K	Black	305615	180
26 W	35°	On-Off	3150 lm	4000 K	Black	317991	180
26 W	35°	1-10V	3050 lm	3000 K	White	307572	200
26 W	35°	1-10V	3050 lm	3000 K	Black	307565	200
26 W	35°	DALI	3050 lm	3000 K	White	307596	235
26 W	35°	DALI	3050 lm	3000 K	Black	307589	235
26 W	35°	DALI	3150 lm	4000 K	Black	322001	235

EGO TRACK DOUBLE

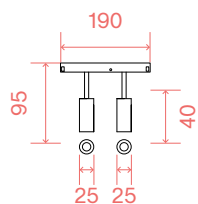
SYSTEMS



IP20 MacAdam: SDCM 3 CRI: ≥90 LED LIFE: 50.000 h



LED SMD OSRAM

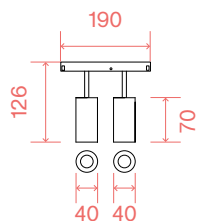


90° 355°

0,120 Kg
0,0041 m³

POWER	BEAM	CONTROL	LUMEN	CCT	FINISH	CODE	€
5 W	30°	On-Off	400 lm	3000 K	White	282947	120
5 W	30°	On-Off	400 lm	3000 K	Black	257624	120
5 W	30°	On-Off	400 lm	3000 K	Brass	282008	120
5 W	30°	On-Off	430 lm	4000 K	Black	321714	120
5 W	30°	1-10V	400 lm	3000 K	White	303611	145
5 W	30°	1-10V	400 lm	3000 K	Black	303604	145
5 W	30°	DALI	400 lm	3000 K	White	286341	170
5 W	30°	DALI	400 lm	3000 K	Black	286334	170
5 W	30°	DALI	430 lm	4000 K	Black	321677	170

LED COB CITIZEN

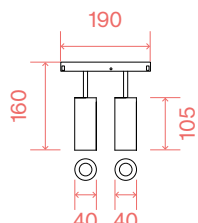


90° 355°

0,260 Kg
0,0041 m³

POWER	BEAM	CONTROL	LUMEN	CCT	FINISH	CODE	€
16 W	30°	On-Off	1500 lm	3000 K	White	282954	160
16 W	30°	On-Off	1500 lm	3000 K	Black	257648	160
16 W	30°	On-Off	1500 lm	3000 K	Brass	282015	160
16 W	30°	On-Off	1550 lm	4000 K	Black	321806	160
16 W	30°	1-10V	1500 lm	3000 K	White	303635	190
16 W	30°	1-10V	1500 lm	3000 K	Black	303628	190
16 W	30°	DALI	1500 lm	3000 K	White	286365	210
16 W	30°	DALI	1500 lm	3000 K	Black	286358	210
16 W	30°	DALI	1550 lm	4000 K	Black	321721	210

LED COB CITIZEN



90° 355°

0,340 Kg
0,0041 m³

POWER	BEAM	CONTROL	LUMEN	CCT	FINISH	CODE	€
24 W	30°	On-Off	2400 lm	3000 K	White	282961	170
24 W	30°	On-Off	2400 lm	3000 K	Black	257662	170
24 W	30°	On-Off	2400 lm	3000 K	Brass	282022	170
24 W	30°	On-Off	2500 lm	4000 K	Black	321844	170
24 W	30°	1-10V	2400 lm	3000 K	White	303659	195
24 W	30°	1-10V	2400 lm	3000 K	Black	303642	195
24 W	30°	DALI	2400 lm	3000 K	White	286389	220
24 W	30°	DALI	2400 lm	3000 K	Black	286372	220
24 W	30°	DALI	2500 lm	4000 K	Black	321899	220

FILTER HONEYCOMB

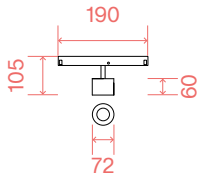
MODEL	REQUIRED	CODE	€
Ego 5 W	No	260853	5
Ego 16 W	No	260860	5
Ego 24 W	No	260860	5

EGO TRACK BIG

SYSTEMS



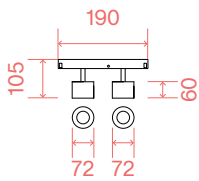
IP20 MacAdam: SDCM 3 UGR: <19 CRI: ≥90 LED LIFE: 50.000 h



0,350 Kg
0,0035 m³

LED COB CITIZEN

POWER	BEAM	CONTROL	LUMEN	CCT	FINISH	CODE	€
10 W	38°	On-Off	1000 lm	3000 K	White	327556	140
10 W	38°	On-Off	1000 lm	3000 K	Black	300764	140



0,750 Kg
0,0026 m³

LED COB CITIZEN

POWER	BEAM	CONTROL	LUMEN	CCT	FINISH	CODE	€
20 W	38°	On-Off	2000 lm	3000 K	White	327549	240
20 W	38°	On-Off	2000 lm	3000 K	Black	316307	240

EGO TRACK FLAT

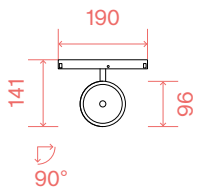
SYSTEMS



IP20 MacAdam: SDCM 3 CRI: ≥90 LED LIFE: 50.000 h



↑ PHOTO p. 306



0,350 Kg
0,0060 m³

LED COB CITIZEN

POWER	BEAM	CONTROL	LUMEN	CCT	FINISH	CODE	€
9 W	36°	On-Off	1100 lm	3000 K	White	300504	125
9 W	36°	On-Off	1100 lm	3000 K	Black	290614	125
9 W	36°	On-Off	1100 lm	3000 K	Brass	300511	125
9 W	36°	1-10V	1100 lm	3000 K	White	303741	140
9 W	36°	1-10V	1100 lm	3000 K	Black	303727	140
9 W	36°	1-10V	1100 lm	3000 K	Brass	303734	140
9 W	36°	DALI	1100 lm	3000 K	White	300535	175
9 W	36°	DALI	1100 lm	3000 K	Black	300528	175
9 W	36°	DALI	1100 lm	3000 K	Brass	300542	175

EGO ACCENT

SYSTEMS

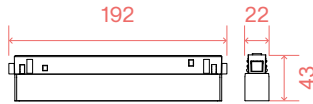


IP20 MacAdam: SDCM 3 UGR: <19 CRI: ≥90 LED LIFE: 50.000 h



↑ PHOTO p. 313

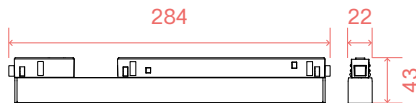
0,140 Kg
0,0013 m³



LED SMD OSRAM

POWER	BEAM	CONTROL	LUMEN	CCT	FINISH	CODE	€
7 W	35°	On-Off	700 lm	3000 K	White	282633	115
7 W	35°	On-Off	700 lm	3000 K	Black	257792	115
7 W	35°	On-Off	730 lm	4000 K	Black	323596	115
7 W	35°	1-10V	700 lm	3000 K	White	303505	155
7 W	35°	1-10V	700 lm	3000 K	Black	303499	155
7 W	35°	DALI	700 lm	3000 K	White	286068	170
7 W	35°	DALI	700 lm	3000 K	Black	286051	170
7 W	35°	DALI	730 lm	4000 K	Black	321790	170

0,210 Kg
0,0019 m³



LED SMD OSRAM

POWER	BEAM	CONTROL	LUMEN	CCT	FINISH	CODE	€
13 W	35°	On-Off	1300 lm	3000 K	White	282640	165
13 W	35°	On-Off	1300 lm	3000 K	Black	257686	165
13 W	35°	On-Off	1350 lm	4000 K	Black	317953	165
13 W	35°	1-10V	1300 lm	3000 K	White	303529	190
13 W	35°	1-10V	1300 lm	3000 K	Black	303512	190
13 W	35°	DALI	1300 lm	3000 K	White	286082	230
13 W	35°	DALI	1300 lm	3000 K	Black	286075	230
13 W	35°	DALI	1350 lm	4000 K	Black	321820	230

EGO WIDE

SYSTEMS

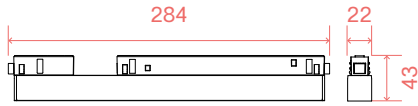


IP20 MacAdam: SDCM 3 CRI: ≥90 LED LIFE: 50.000 h



↑ PHOTO p. 310

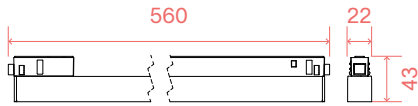
0,200 Kg
0,0004 m³



LED SMD SAMSUNG

POWER	BEAM	CONTROL	LUMEN	CCT	FINISH	CODE	€
7 W	110°	On-Off	850 lm	3000 K	White	283029	85
7 W	110°	On-Off	850 lm	3000 K	Black	257709	85
7 W	110°	On-Off	880 lm	4000 K	Black	317960	85
7 W	110°	1-10V	850 lm	3000 K	White	303796	130
7 W	110°	1-10V	850 lm	3000 K	Black	303789	130
7 W	110°	DALI	850 lm	3000 K	White	286501	145
7 W	110°	DALI	850 lm	3000 K	Black	286495	145
7 W	110°	DALI	880 lm	4000 K	Black	322025	145

0,340 Kg
0,0006 m³



LED SMD SAMSUNG

POWER	BEAM	CONTROL	LUMEN	CCT	FINISH	CODE	€
13 W	110°	On-Off	1700 lm	3000 K	White	283036	118
13 W	110°	On-Off	1700 lm	3000 K	Black	257716	118
13 W	110°	On-Off	1750 lm	4000 K	Black	322056	118
13 W	110°	1-10V	1700 lm	3000 K	White	303819	165
13 W	110°	1-10V	1700 lm	3000 K	Black	303802	165
13 W	110°	DALI	1700 lm	3000 K	White	286525	170
13 W	110°	DALI	1700 lm	3000 K	Black	286518	170
13 W	110°	DALI	1750 lm	4000 K	Black	322032	170

EGO WIDE

SYSTEMS



IP20

MacAdam: SDCM 3

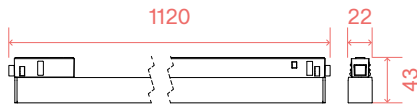
CRI: ≥90

LED LIFE: 50.000 h



PHOTO p. 310

0,620 Kg
0,0013 m³



LED SMD SAMSUNG

POWER	BEAM	CONTROL	LUMEN	CCT	FINISH	CODE	€
26 W	110°	On-Off	3400 lm	3000 K	White	283043	170
26 W	110°	On-Off	3400 lm	3000 K	Black	257730	170
26 W	110°	On-Off	3500 lm	4000 K	Black	322070	170
26 W	110°	1-10V	3400 lm	3000 K	White	303833	200
26 W	110°	1-10V	3400 lm	3000 K	Black	303826	200
26 W	110°	DALI	3400 lm	3000 K	White	286549	215
26 W	110°	DALI	3400 lm	3000 K	Black	286532	215
26 W	110°	DALI	3500 lm	4000 K	Black	322063	215

EGO FLEXIBLE ACCENT

SYSTEMS



IP20

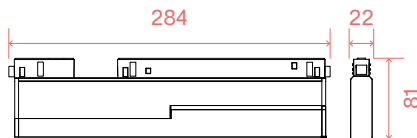
MacAdam: SDCM 3

CRI: ≥90

UGR <19 LED LIFE: 50.000 h



0,470 Kg
0,0031 m³



90°

LED SMD SAMSUNG

POWER	BEAM	CONTROL	LUMEN	CCT	FINISH	CODE	€
13 W	35°	On-Off	1300 lm	3000 K	White	282718	200
13 W	35°	On-Off	1300 lm	3000 K	Black	257846	200
13 W	35°	1-10V	1300 lm	3000 K	White	303543	225
13 W	35°	1-10V	1300 lm	3000 K	Black	303536	225
13 W	35°	DALI	1300 lm	3000 K	White	286105	250
13 W	35°	DALI	1300 lm	3000 K	Black	286099	250

EGO FLEXIBLE WIDE

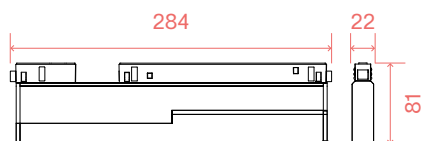
SYSTEMS



IP20 MacAdam: SDCM 3 CRI: ≥ 90 LED LIFE: 50.000 h



0,490 Kg
0,0032 m³



LED SMD SAMSUNG

POWER	BEAM	CONTROL	LUMEN	CCT	FINISH	CODE	€
7 W	110°	On-Off	850 lm	3000 K	White	282725	135
7 W	110°	On-Off	850 lm	3000 K	Black	257839	135
7 W	110°	1-10V	850 lm	3000 K	White	303567	165
7 W	110°	1-10V	850 lm	3000 K	Black	303550	165
7 W	110°	DALI	850 lm	3000 K	White	286129	185
7 W	110°	DALI	850 lm	3000 K	Black	286112	185

EGO PENDANT

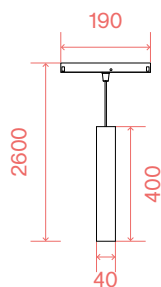
SYSTEMS



IP20 MacAdam: SDCM 3 UGR: <19 CRI: ≥90 LED LIFE: 50.000 h



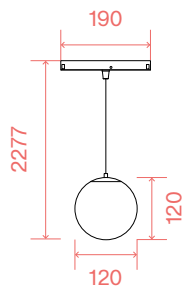
LED COB CITIZEN (UGR <19)



0,540 Kg
0,0038 m³

POWER	BEAM	CONTROL	LUMEN	CCT	FINISH	CODE	€
12 W	30°	On-Off	1100 lm	3000 K	White	282879	165
12 W	30°	On-Off	1100 lm	3000 K	Black	257747	165
12 W	30°	On-Off	1100 lm	3000 K	Brass	283852	165
12 W	30°	On-Off	1150 lm	4000 K	Black	321653	165
12 W	30°	1-10V	1100 lm	3000 K	White	303598	200
12 W	30°	1-10V	1100 lm	3000 K	Black	303574	200
12 W	30°	1-10V	1100 lm	3000 K	Brass	303581	200
12 W	30°	DALI	1100 lm	3000 K	White	286327	215
12 W	30°	DALI	1100 lm	3000 K	Black	286310	215
12 W	30°	DALI	1100 lm	3000 K	Brass	300498	215
12 W	30°	DALI	1150 lm	4000 K	Black	321837	215

LED COB CITIZEN

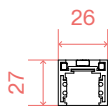


0,650 Kg
0,0125 m³

POWER	BEAM	CONTROL	LUMEN	CCT	FINISH	CODE	€
10 W	-	On-Off	1000 lm	3000 K	White	327532	170
10 W	-	On-Off	1000 lm	3000 K	Black	327525	170

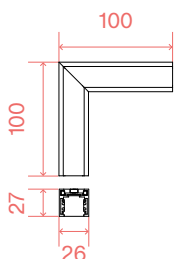
EGO - LOW

SYSTEMS



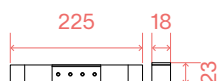
TRACK LOW (NO MOUNTING KIT REQUIRED, DIRECT CEILING INSTALLATION)
MAXIMUM LENGTH PER POWER SOURCE: 25 METERS)

LENGTH	WEIGHT	VOLUME	FINISH	CODE	€
1000 mm	0,68 Kg	0,0013 m ³	White	282909	57
1000 mm	0,68 Kg	0,0013 m ³	Black	257877	57
2000 mm	1,36 Kg	0,0026 m ³	White	282916	115
2000 mm	1,36 Kg	0,0026 m ³	Black	266121	115



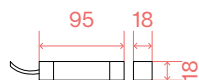
CONNECTOR HORIZONTAL LOW (OPTIONAL)

WEIGHT	VOLUME	CONTROL	FINISH	CODE	€
0,07 Kg	0,0015 m ³	On-Off	White	282848	95
0,07 Kg	0,0015 m ³	On-Off	Black	257990	95
0,07 Kg	0,0015 m ³	1-10V / DALI	White	286266	100
0,07 Kg	0,0015 m ³	1-10V / DALI	Black	286259	100



LINEAR CONNECTOR (REQUIRED - 1 KIT X LINEAR CONNECTION)

WEIGHT	VOLUME	CONTROL	FINISH	CODE	€
0,16 Kg	0,0005 m ³	On-Off	White	285993	50
0,16 Kg	0,0005 m ³	On-Off	Black	283104	50
0,16 Kg	0,0005 m ³	1-10V / DALI	White	288338	55
0,16 Kg	0,0005 m ³	1-10V / DALI	Black	289281	55



MAIN CONNECTOR (REQUIRED - YES - 1 KIT X POWER SOURCE MAX 210 W)

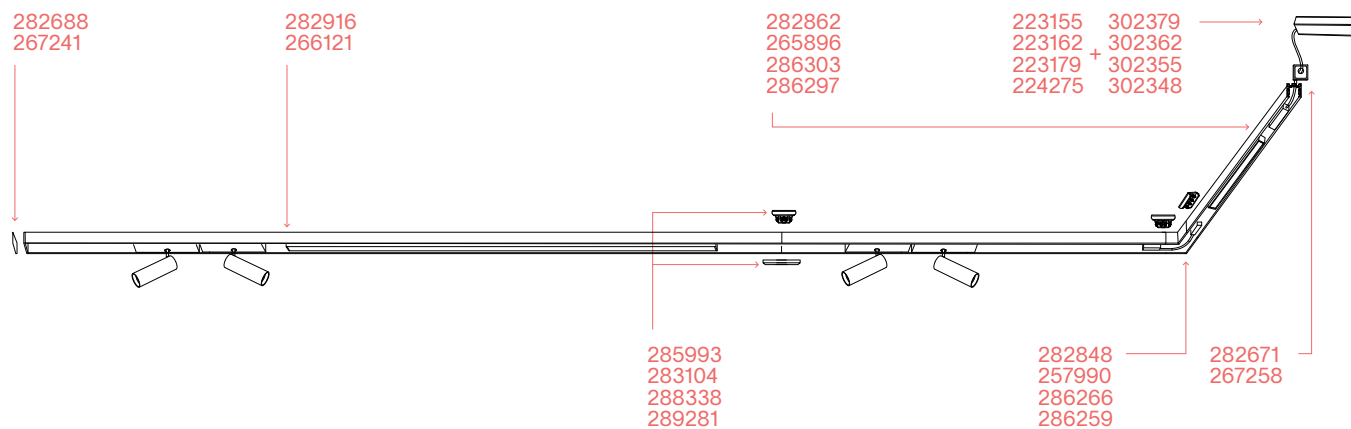
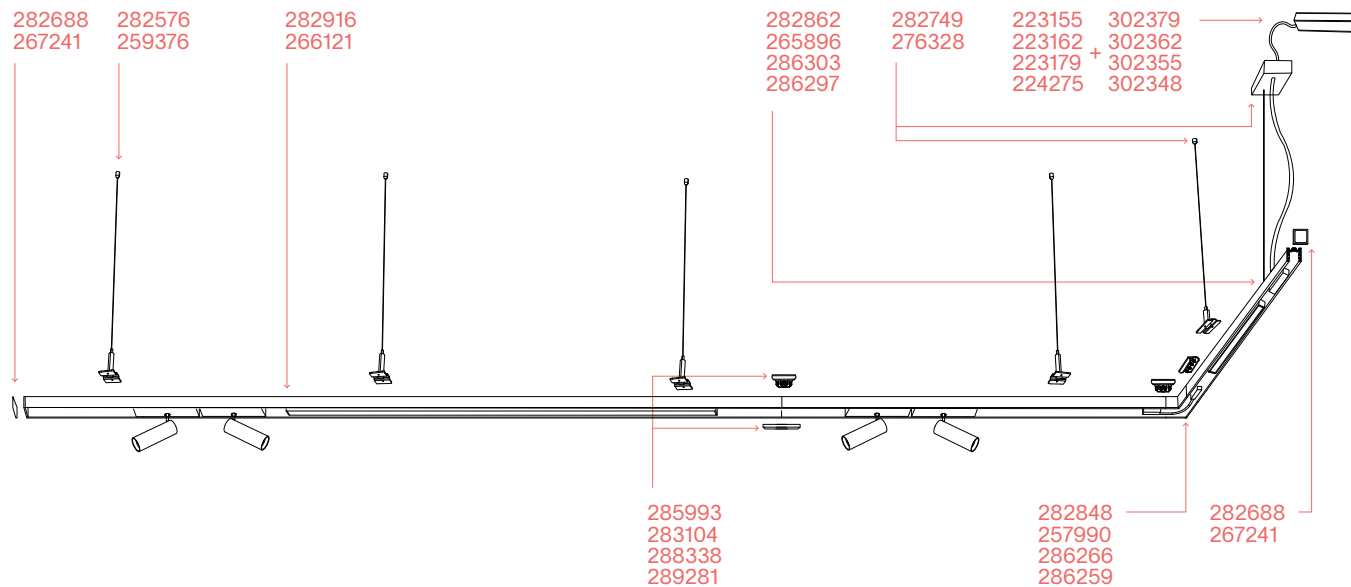
WEIGHT	VOLUME	CONTROL	FINISH	CODE	€
0,12 Kg	0,0005 m ³	On-Off	White	282862	36
0,12 Kg	0,0005 m ³	On-Off	Black	265896	36
0,12 Kg	0,0005 m ³	1-10V / DALI	White	286303	50
0,12 Kg	0,0005 m ³	1-10V / DALI	Black	286297	50

Cable length
2000 mm

	REQUIRED	MEASURE (L X H X W)	FINISH	CODE	€
END CAP NO HOLE	YES	26 x 11 x 27 mm	White	282688	6
END CAP NO HOLE	YES	26 x 11 x 27 mm	Black	267241	6
END CAP WITH HOLE	YES	26 x 11 x 27 mm	White	282671	6
END CAP WITH HOLE	YES	26 x 11 x 27 mm	Black	267258	6
SUSPENSION KIT	YES - 1 Kit x power source max 210 W	2000 mm	White	282749	55
SUSPENSION KIT	YES - 1 Kit x power source max 210 W	2000 mm	Black	276328	55
KIT SINGLE CABLE	YES - 1 Kit x 900 mm	2000 mm	White	282756	17
KIT SINGLE CABLE	YES - 1 Kit x 900 mm	2000 mm	Black	259376	17

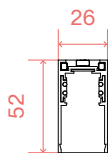
EGO - LOW - ASSEMBLY PLANS

SYSTEMS



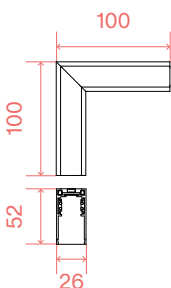
EGO - HIGH

SYSTEMS



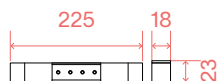
TRACK HIGH (NO MOUNTING KIT REQUIRED, DIRECT CEILING INSTALLATION
MAXIMUM LENGTH PER POWER SOURCE: 25 METERS)

LENGTH	WEIGHT	VOLUME	FINISH	CODE	€
1000 mm	0,80 Kg	0,0023 m ³	White	282886	62
1000 mm	0,80 Kg	0,0023 m ³	Black	258027	62
2000 mm	1,60 Kg	0,0046 m ³	White	282893	125
2000 mm	1,60 Kg	0,0046 m ³	Black	266145	125



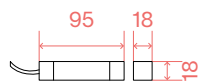
CONNECTOR HORIZONTAL HIGH (OPTIONAL)

WEIGHT	VOLUME	CONTROL	FINISH	CODE	€
0,10 Kg	0,0015 m ³	On-Off	White	282824	90
0,10 Kg	0,0015 m ³	On-Off	Black	258140	90
0,10 Kg	0,0015 m ³	1-10V / DALI	White	286228	100
0,10 Kg	0,0015 m ³	1-10V / DALI	Black	286211	100



LINEAR CONNECTOR (REQUIRED - 1 KIT X LINEAR CONNECTION)

WEIGHT	VOLUME	CONTROL	FINISH	CODE	€
0,16 Kg	0,0005 m ³	On-Off	White	285993	50
0,16 Kg	0,0005 m ³	On-Off	Black	283104	50
0,16 Kg	0,0005 m ³	1-10V / DALI	White	288338	55
0,16 Kg	0,0005 m ³	1-10V / DALI	Black	289281	55



MAIN CONNECTOR (REQUIRED - 1 KIT X POWER SOURCE MAX 210W)

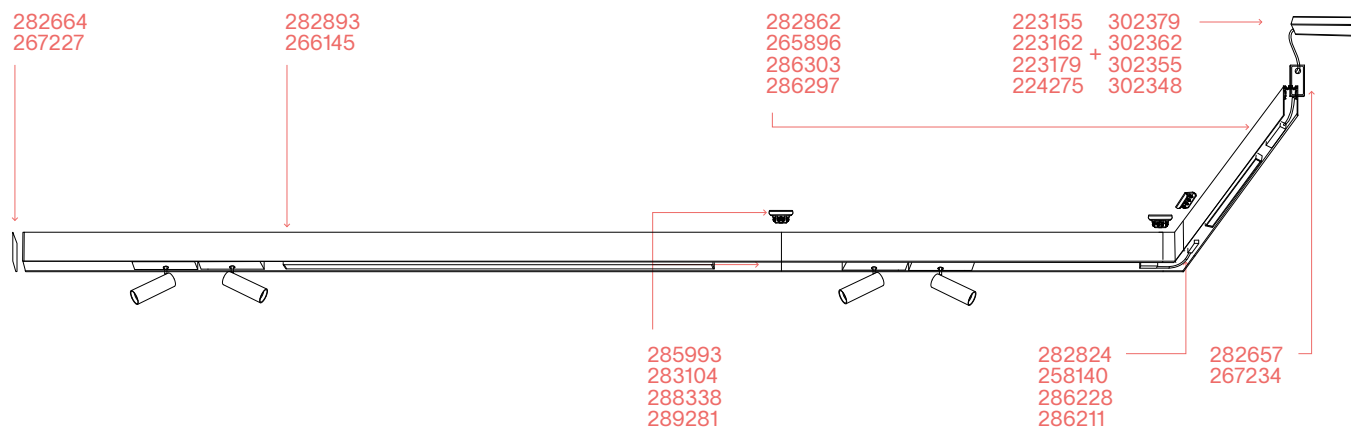
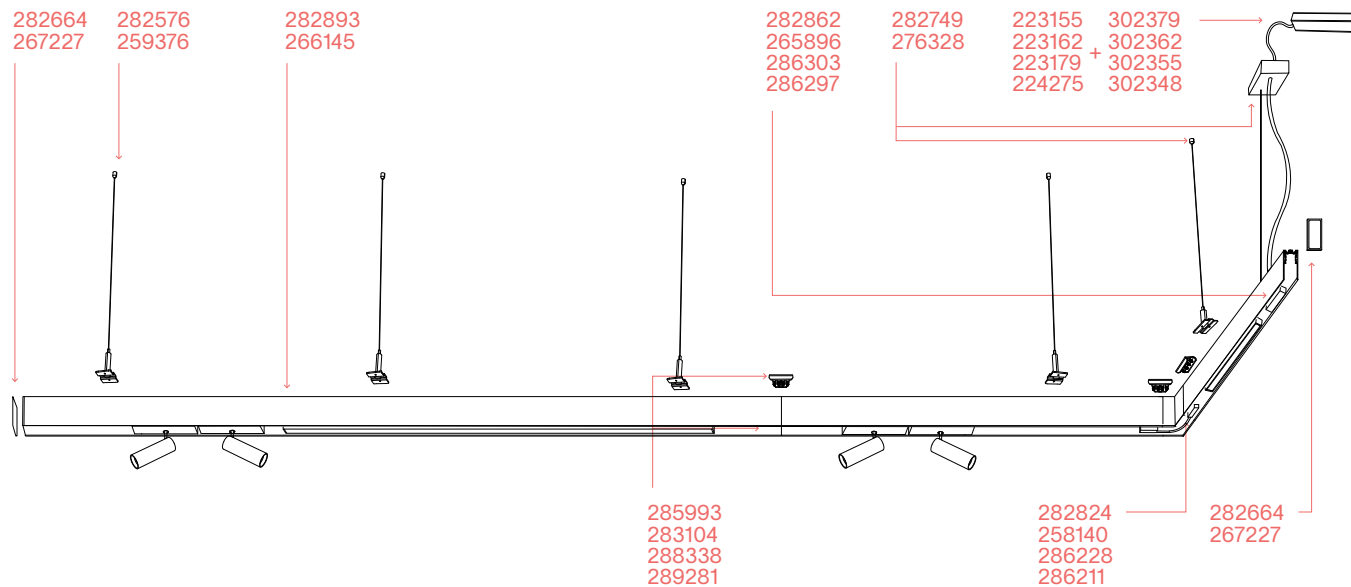
WEIGHT	VOLUME	CONTROL	FINISH	CODE	€
0,12 Kg	0,0005 m ³	On-Off	White	282862	36
0,12 Kg	0,0005 m ³	On-Off	Black	265896	36
0,12 Kg	0,0005 m ³	1-10V / DALI	White	286303	50
0,12 Kg	0,0005 m ³	1-10V / DALI	Black	286297	50

Cable length
2000 mm

	REQUIRED	MEASURE (L X H X W)	FINISH	CODE	€
END CAP NO HOLE	YES	26 x 11 x 52 mm	White	282664	6
END CAP NO HOLE	YES	26 x 11 x 52 mm	Black	267227	6
END CAP WITH HOLE	YES	26 x 11 x 52 mm	White	282657	6
END CAP WITH HOLE	YES	26 x 11 x 52 mm	Black	267234	6
SUSPENSION KIT	YES - 1 Kit x power source max 210W	2000 mm	White	282749	55
SUSPENSION KIT		2000 mm	Black	276328	55
KIT SINGLE CABLE	YES - 1 Kit x 900 mm	2000 mm	White	282756	17
KIT SINGLE CABLE		2000 mm	Black	259376	17
BLINDED COVER	NO	1000 x 5 x 24 mm	White	282770	17
BLINDED COVER	NO	1000 x 5 x 24 mm	Black	258256	17

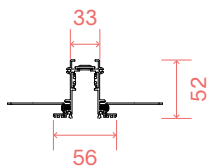
EGO - HIGH - ASSEMBLY PLANS

SYSTEMS



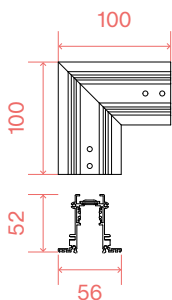
EGO - RECESSED

SYSTEMS



TRACK (KIT FOR ASSEMBLY PROFILE INCLUDED)
MAXIMUM LENGHT PER POWER SOURCE: 25 METERS)

LENGTH	WEIGHT	VOLUME	FINISH	CODE	€
1000 mm	1,13 Kg	0,0039 m ³	White	282923	71
1000 mm	1,13 Kg	0,0039 m ³	Black	258171	71
2000 mm	2,26 Kg	0,0078 m ³	White	282930	150
2000 mm	2,26 Kg	0,0078 m ³	Black	266183	150



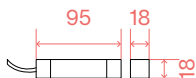
CONNECTOR HORIZONTAL (OPTIONAL)

WEIGHT	VOLUME	CONTROL	FINISH	CODE	€
0,13 Kg	0,0015 m ³	On-Off	White	282787	90
0,13 Kg	0,0015 m ³	On-Off	Black	258232	90
0,13 Kg	0,0015 m ³	1-10V / DALI	White	286204	125
0,13 Kg	0,0015 m ³	1-10V / DALI	Black	286167	125



LINEAR CONNECTOR (REQUIRED - 1 KIT X LINEAR CONNECTION)

WEIGHT	VOLUME	CONTROL	FINISH	CODE	€
0,16 Kg	0,0005 m ³	On-Off	White	286006	50
0,16 Kg	0,0005 m ³	On-Off	Black	283111	50
0,16 Kg	0,0005 m ³	1-10V / DALI	White	289298	55
0,16 Kg	0,0005 m ³	1-10V / DALI	Black	289304	55



MAIN CONNECTOR (REQUIRED - 1 KIT X POWER SOURCE MAX 210W)

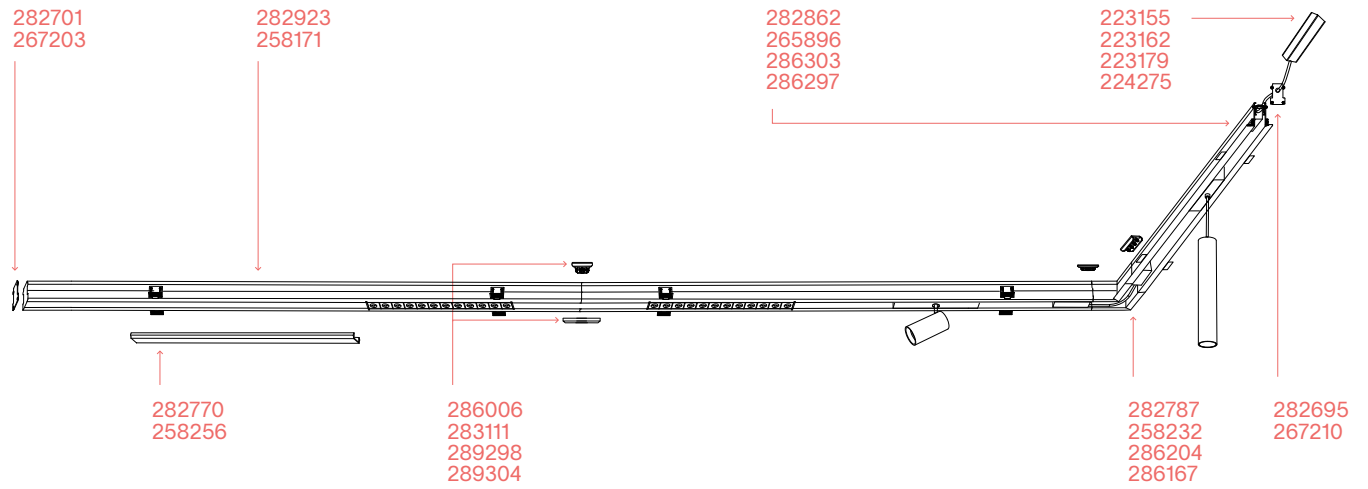
WEIGHT	VOLUME	CONTROL	FINISH	CODE	€
0,12 Kg	0,0005 m ³	On-Off	White	282862	36
0,12 Kg	0,0005 m ³	On-Off	Black	265896	36
0,12 Kg	0,0005 m ³	1-10V / DALI	White	286303	50
0,12 Kg	0,0005 m ³	1-10V / DALI	Black	286297	50

Cable length
2000 mm

	REQUIRED	MEASURE (L X H X W)	FINISH	CODE	€
END CAP NO HOLE	YES	36 x 4 x 52 mm	White	282701	5
END CAP NO HOLE	YES	36 x 4 x 52 mm	Black	267203	5
END CAP WITH HOLE	YES	36 x 4 x 52 mm	White	282695	6
END CAP WITH HOLE	YES	36 x 4 x 52 mm	Black	267210	6
BLINDED COVER	NO	1000 x 5 x 24 mm	White	282770	17
BLINDED COVER	NO	1000 x 5 x 24 mm	Black	258256	17
INSTALLATION TOOL	NO		Black	292922	31

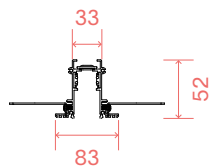
EGO - RECESSED - ASSEMBLY PLANS

SYSTEMS



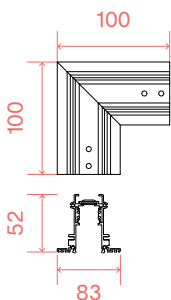
EGO - RECESSED EASY

SYSTEMS



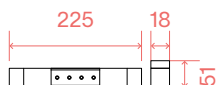
TRACK (NO MOUNTING KIT REQUIRED, DIRECT CEILING INSTALLATION)
MAXIMUM LENGTH PER POWER SOURCE: 25 METERS)

LENGTH	WEIGHT	VOLUME	FINISH	CODE	€
1000 mm	1,16 Kg	0,0058 m ³	White	320489	85
1000 mm	1,16 Kg	0,0058 m ³	Black	320472	85
2000 mm	2,40 Kg	0,0122 m ³	White	320502	170
2000 mm	2,40 Kg	0,0122 m ³	Black	320496	170



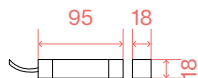
CONNECTOR HORIZONTAL (OPTIONAL)

WEIGHT	VOLUME	CONTROL	FINISH	CODE	€
0,30 Kg	0,0010 m ³	On-Off	White	320748	115
0,30 Kg	0,0010 m ³	On-Off	Black	320731	115
0,30 Kg	0,0010 m ³	1-10V / DALI	White	320724	135
0,30 Kg	0,0010 m ³	1-10V / DALI	Black	320717	135



LINEAR CONNECTOR (REQUIRED - 1 KIT X LINEAR CONNECTION)

WEIGHT	VOLUME	CONTROL	FINISH	CODE	€
0,16 Kg	0,0005 m ³	On-Off	White	286006	50
0,16 Kg	0,0005 m ³	On-Off	Black	283111	50
0,16 Kg	0,0005 m ³	1-10V / DALI	White	289298	55
0,16 Kg	0,0005 m ³	1-10V / DALI	Black	289304	55



MAIN CONNECTOR (REQUIRED - 1 KIT X POWER SOURCE MAX 210W)

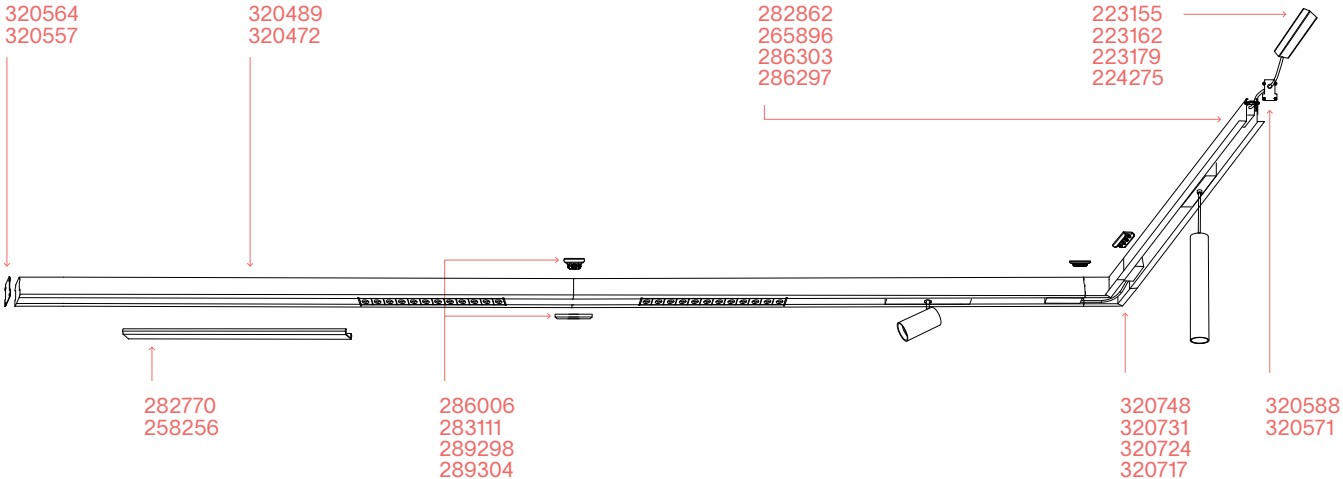
WEIGHT	VOLUME	CONTROL	FINISH	CODE	€
0,12 Kg	0,0005 m ³	On-Off	White	282862	36
0,12 Kg	0,0005 m ³	On-Off	Black	265896	36
0,12 Kg	0,0005 m ³	1-10V / DALI	White	286303	50
0,12 Kg	0,0005 m ³	1-10V / DALI	Black	286297	50

Cable length
2000 mm

	REQUIRED	MEASURE (L X H X W)	FINISH	CODE	€
END CAP NO HOLE	YES	83 x 52 x 30 mm	White	320564	8
END CAP NO HOLE	YES	83 x 52 x 30 mm	Black	320557	8
END CAP WITH HOLE	YES	83 x 52 x 30 mm	White	320588	10
END CAP WITH HOLE	YES	83 x 52 x 30 mm	Black	320571	10
BLINDED COVER	NO	1000 x 5 x 24 mm	White	282770	17
BLINDED COVER	NO	1000 x 5 x 24 mm	Black	258256	17

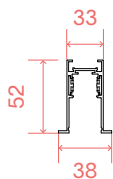
EGO - RECESSED EASY - ASSEMBLY PLANS

SYSTEMS



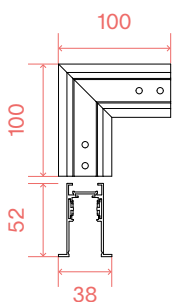
EGO - RECESSED TRIM

SYSTEMS



TRACK (KIT FOR ASSEMBLY PROFILE INCLUDED)
MAXIMUM LENGHT PER POWER SOURCE: 25 METERS)

LENGTH	WEIGHT	VOLUME	FINISH	CODE	€
1000 mm	1,13 Kg	0,0058 m ³	White	320441	85
1000 mm	1,13 Kg	0,0058 m ³	Black	320434	85
2000 mm	2,25 Kg	0,0122 m ³	White	320465	170
2000 mm	2,25 Kg	0,0122 m ³	Black	320458	170



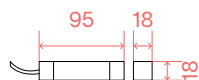
CONNECTOR HORIZONTAL (OPTIONAL)

WEIGHT	VOLUME	CONTROL	FINISH	CODE	€
0,30 Kg	0,0010 m ³	On-Off	White	320625	125
0,30 Kg	0,0010 m ³	On-Off	Black	320618	125
0,30 Kg	0,0010 m ³	1-10V / DALI	White	320601	145
0,30 Kg	0,0010 m ³	1-10V / DALI	Black	320595	145



LINEAR CONNECTOR (REQUIRED - 1 KIT X LINEAR CONNECTION)

WEIGHT	VOLUME	CONTROL	FINISH	CODE	€
0,16 Kg	0,0005 m ³	On-Off	White	286006	50
0,16 Kg	0,0005 m ³	On-Off	Black	283111	50
0,16 Kg	0,0005 m ³	1-10V / DALI	White	289298	55
0,16 Kg	0,0005 m ³	1-10V / DALI	Black	289304	55



MAIN CONNECTOR (REQUIRED - 1 KIT X POWER SOURCE MAX 210W)

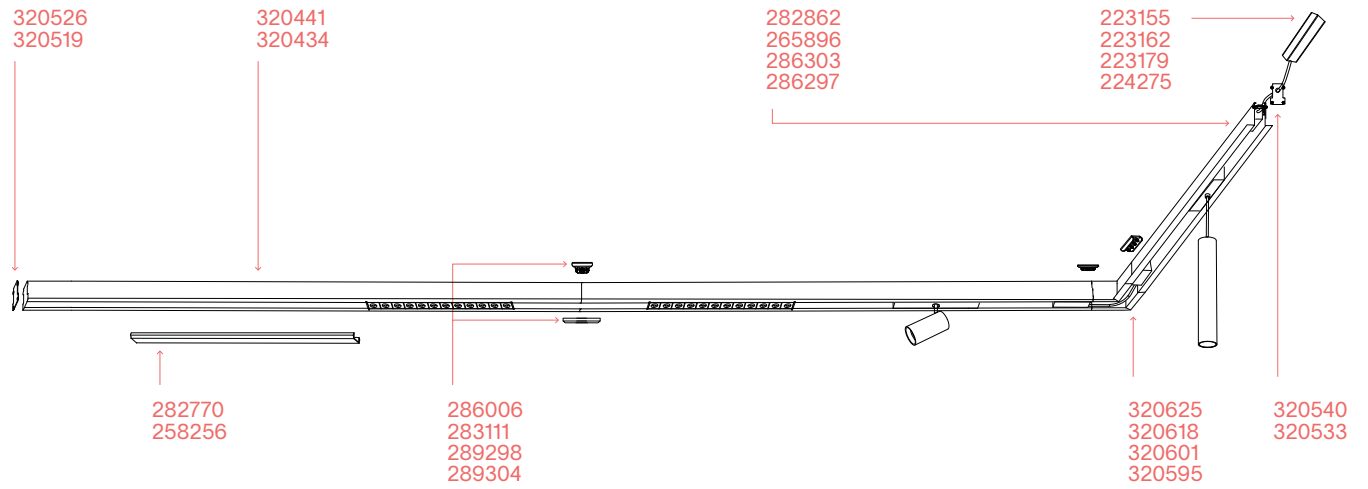
WEIGHT	VOLUME	CONTROL	FINISH	CODE	€
0,12 Kg	0,0005 m ³	On-Off	White	282862	36
0,12 Kg	0,0005 m ³	On-Off	Black	265896	36
0,12 Kg	0,0005 m ³	1-10V / DALI	White	286303	50
0,12 Kg	0,0005 m ³	1-10V / DALI	Black	286297	50

Cable length
2000 mm

	REQUIRED	MEASURE (L X H X W)	FINISH	CODE	€
END CAP NO HOLE	YES	38 x 52 x 17 mm	White	320526	6
END CAP NO HOLE	YES	38 x 52 x 17 mm	Black	320519	6
END CAP WITH HOLE	YES	38 x 52 x 17 mm	White	320540	9
END CAP WITH HOLE	YES	38 x 52 x 17 mm	Black	320533	9
BLINDED COVER	NO	1000 x 5 x 24 mm	White	282770	17
BLINDED COVER	NO	1000 x 5 x 24 mm	Black	258256	17

EGO - RECESSED TRIM - ASSEMBLY PLANS

SYSTEMS



EGO - DRIVERS

SYSTEMS

DRIVER MEANWELL ON/OFF (REQUIRED)



POWER	OUTPUT	MEASURE (L X H X W)	DRIVER BOX	CODE	€
75 W	48 Vdc	171x37x62 mm	255x55x75 mm	223155	140
100 W	48 Vdc	220x37x68 mm	330x60x80 mm	223162	185
150 W	48 Vdc	228x37x68 mm	330x60x80 mm	223179	205
240 W	48 Vdc	244x39x68 mm	330x60x80 mm	224275	230

DRIVER BOX (OPTIONAL)

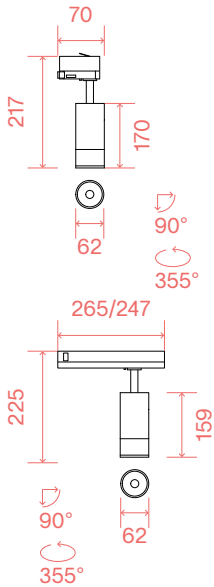
MATERIALE	MEASURE	FINISH	CODE	€
Metal	255x55x75 mm	White	302379	25
Metal	255x55x75 mm	Black	302362	25
Metal	330x60x80 mm	White	302355	30
Metal	330x60x80 mm	Black	302348	30

MAGNETIC DRIVER (REQUIRED - CABLE LENGTH 2000 MM IT REPLACES DRIVER + MAIN CONNECTOR*)

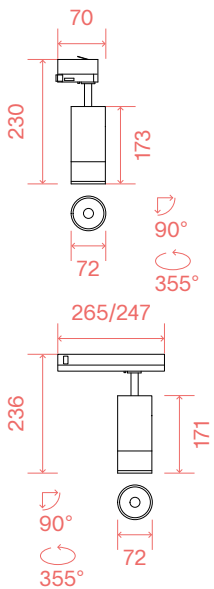


POWER	OUTPUT	MEASURE (L X H X W)	CODE	€
100 W	48 Vdc	297x20x16 mm	296302	90
150 W	48 Vdc	268x43x16 mm	325750	95
250 W	48 Vdc	268x43x16 mm	325767	110

*Codes 325750 and 325767 suggested use with HIGH and RECESSED versions.



0,710 Kg
0,0042 m³



1,100 Kg
0,0050 m³

LED COB BRIDGELUX (DRIVER INCLUDED)

POWER	BEAM	CONTROL	LUMEN	CCT	FINISH	CODE	€
15 W	20-55°	On-Off	1550 lm	3000 K	White	286594	73
15 W	20-55°	On-Off	1550 lm	3000 K	Black	276182	73
15 W	20-55°	On-Off	1600 lm	4000 K	White	322094	73
15 W	20-55°	On-Off	1600 lm	4000 K	Black	322087	73
15 W	20-55°	1-10V	1550 lm	3000 K	White	302959	116
15 W	20-55°	1-10V	1550 lm	3000 K	Black	302942	116
15 W	20-55°	DALI	1550 lm	3000 K	White	302997	135
15 W	20-55°	DALI	1550 lm	3000 K	Black	302980	135

LED COB BRIDGELUX (DRIVER INCLUDED)

POWER	BEAM	CONTROL	LUMEN	CCT	FINISH	CODE	€
25 W	20-55°	On-Off	2250 lm	3000 K	White	286600	92
25 W	20-55°	On-Off	2250 lm	3000 K	Black	276243	92
25 W	20-55°	On-Off	2700 lm	4000 K	White	322124	92
25 W	20-55°	On-Off	2700 lm	4000 K	Black	322100	92
25 W	20-55°	1-10V	2550 lm	3000 K	White	302973	135
25 W	20-55°	1-10V	2550 lm	3000 K	Black	302966	135
25 W	20-55°	DALI	2550 lm	3000 K	White	303017	155
25 W	20-55°	DALI	2550 lm	3000 K	Black	303000	155

	REQUIRED	DRIVER	FINISH	CODE	€
SINGLE CONNECTION	NO	On/Off	White	170145	27
SINGLE CONNECTION	NO	On/Off	Black	170152	27

FLUO ACCENT

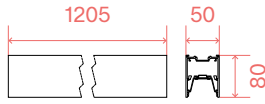
SYSTEMS



IP20 MacAdam: SDCM 3 UGR: <13 CRI: ≥80 LED LIFE: 50.000 h



2,760 Kg
0,0183 m³
Cable length
2150 mm



LED SMD OSRAM (DRIVER TRIDONIC ON/OFF INCLUDED)

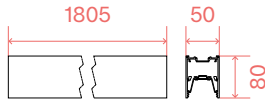
POWER	BEAM	LUMEN	CCT	FINISH	CODE	€
30 W	30°	2750 lm	3000 K	White	192611	360
30 W	30°	2750 lm	3000 K	Black	192581	360
30 W	30°	2900 lm	4000 K	White	192543	360
30 W	30°	2900 lm	4000 K	Black	192529	360

DIMMABLE DRIVER* (NOT INCLUDED/OPTIONAL)

	POWER	OUTPUT	MEASURE	CODE	€
1-10V	39 W	700 mA	280 x 21 x 30 mm	216416	145
DALI/Push	38 W	700 mA	280 x 21 x 30 mm	216270	160

*The dimmable power supplies must be ordered in concomitance with the product and will be included inside the fittings by replacing the on-off power supply. The linear connection is available only for the on-off versions of the products.

3,860 Kg
0,0257 m³
Cable length
2150 mm



LED SMD OSRAM (DRIVER TRIDONIC ON/OFF INCLUDED)

POWER	BEAM	LUMEN	CCT	FINISH	CODE	€
30 W	30°	2750 lm	3000 K	White	192499	430
30 W	30°	2750 lm	3000 K	Black	192475	430
30 W	30°	2900 lm	4000 K	White	192444	430
30 W	30°	2900 lm	4000 K	Black	192420	430

DIMMABLE DRIVER* (NOT INCLUDED/OPTIONAL)

	POWER	OUTPUT	MEASURE	CODE	€
1-10V	39 W	700 mA	280 x 21 x 30 mm	216416	145
DALI/Push	38 W	700 mA	280 x 21 x 30 mm	216270	160

*The dimmable power supplies must be ordered in concomitance with the product and will be included inside the fittings by replacing the on-off power supply. The linear connection is available only for the on-off versions of the products.

FLUO WIDE

SYSTEMS

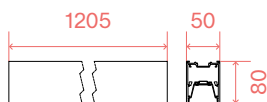


IP20 MacAdam: SDCM 3 CRI: ≥80 LED LIFE: 50.000 h



PHOTO p. 324

2,890 Kg
0,0183 m³
Cable length
2150 mm



LED SMD SAMSUNG (DRIVER TRIDONIC ON/OFF INCLUDED)

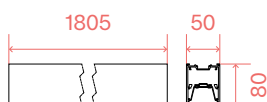
POWER	BEAM	LUMEN	CCT	FINISH	CODE	€
27 W	105°	3750 lm	3000 K	White	192437	330
27 W	105°	3750 lm	3000 K	Black	191997	330
27 W	105°	4050 lm	4000 K	White	192482	330
27 W	105°	4050 lm	4000 K	Black	192505	330

DIMMABLE DRIVER* (NOT INCLUDED/OPTIONAL)

	POWER	OUTPUT	MEASURE	CODE	€
1-10V	28 W	500 mA	280 x 21 x 30 mm	216423	145
DALI/Push	27 W	500 mA	280 x 21 x 30 mm	216287	160

*The dimmable power supplies must be ordered in concomitance with the product and will be included inside the fittings by replacing the on-off power supply. The linear connection is available only for the on-off versions of the products.

4,420 Kg
0,0257 m³
Cable length
2150 mm



LED SMD SAMSUNG (DRIVER TRIDONIC ON/OFF INCLUDED)

POWER	BEAM	LUMEN	CCT	FINISH	CODE	€
36 W	105°	5050 lm	3000 K	White	192550	425
36 W	105°	5050 lm	3000 K	Black	192567	425
36 W	105°	5300 lm	4000 K	White	192604	425
36 W	105°	5300 lm	4000 K	Black	192628	425

DIMMABLE DRIVER* (NOT INCLUDED/OPTIONAL)

	POWER	OUTPUT	MEASURE	CODE	€
1-10V	39 W	700 mA	280 x 21 x 30 mm	216416	145
DALI/Push	38 W	700 mA	280 x 21 x 30 mm	216270	160

*The dimmable power supplies must be ordered in concomitance with the product and will be included inside the fittings by replacing the on-off power supply. The linear connection is available only for the on-off versions of the products.

FLUO BI-EMISSION*

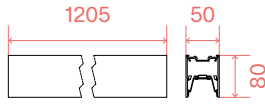
SYSTEMS



IP20 MacAdam: SDCM 3 CRI: ≥80 LED LIFE: 50.000 h



2,890 Kg
0,0183 m³
Cable length
2150 mm



LED SMD SAMSUNG (UP-LIGHT INCLUDED - DRIVER TRIDONIC ON/OFF INCLUDED)

POWER	BEAM	LUMEN	CCT	FINISH	CODE	€
27 W	105°	3250 lm	3000 K	White	192666	425
27 W	105°	3250 lm	3000 K	Black	192710	425
27 W	105°	4050 lm	4000 K	White	192741	425
27 W	105°	4050 lm	4000 K	Black	192758	425

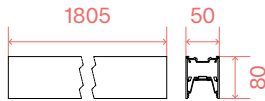
UP-LIGHT INFO

KIT DIMMABLE DRIVER*

POWER	BEAM	LUMEN	CCT		CODE	€
13 W	105°	1750 lm	3000 K	1-10V	270692	230
13 W	105°	2050 lm	4000 K	DALI/Push	270876	260

*Separate switching on of direct and indirect output (available only for on-off versions). Control of the direct and indirect output in synchrony (versions with 1-10V and Push dimming). The dimmable power supplies must be ordered in concomitance with the product and will be included inside the fittings by replacing the on-off power supply. The linear connection is available only for the on-off versions of the products.

4,420 Kg
0,0269 m³
Cable length
2150 mm



LED SMD SAMSUNG (UP-LIGHT INCLUDED - DRIVER TRIDONIC ON/OFF INCLUDED)

POWER	BEAM	LUMEN	CCT	FINISH	CODE	€
36 W	105°	5050 lm	3000 K	White	192703	580
36 W	105°	5050 lm	3000 K	Black	192697	580
36 W	105°	5350 lm	4000 K	White	192673	580
36 W	105°	5350 lm	4000 K	Black	192642	580

UP-LIGHT INFO

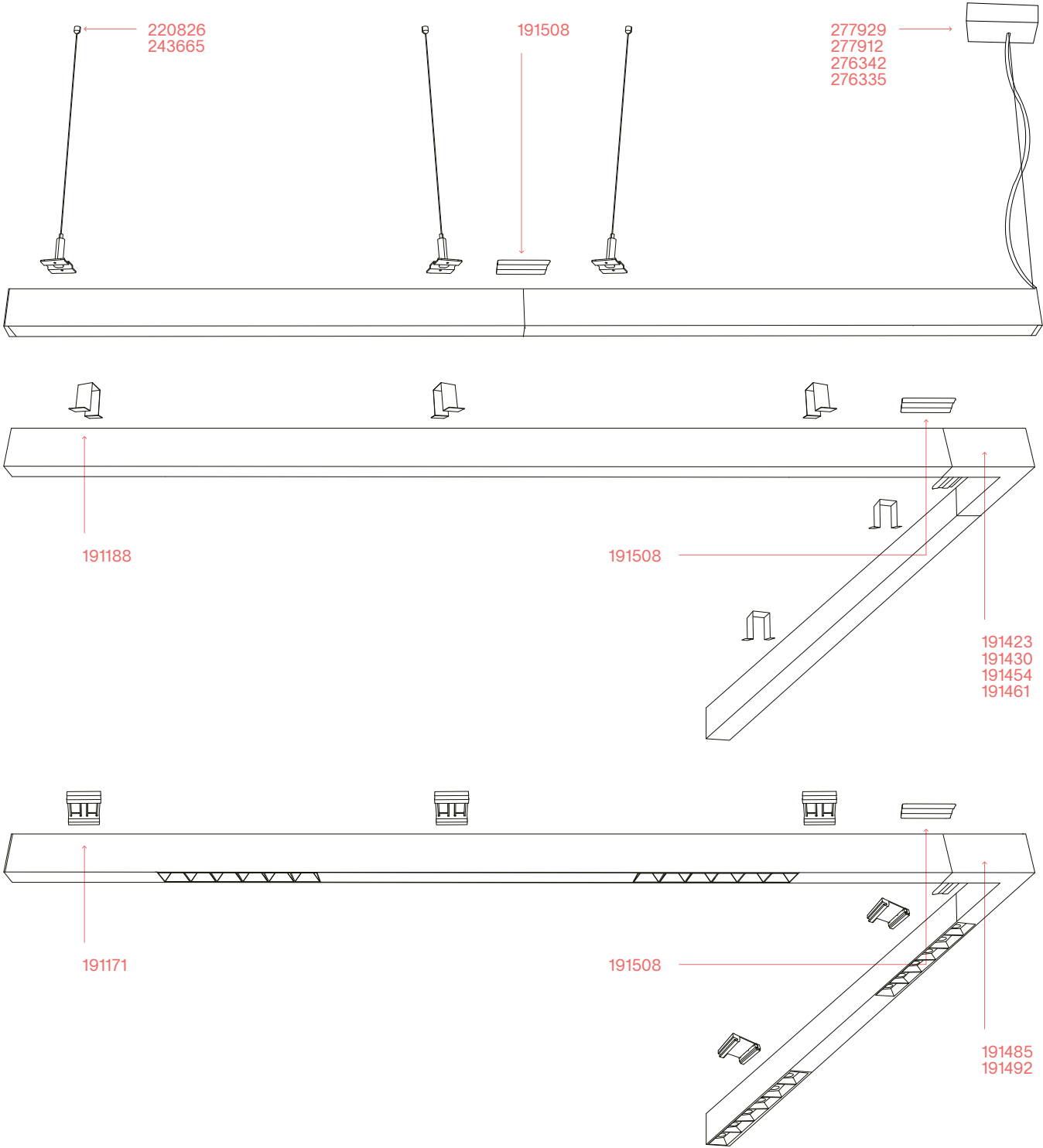
KIT DIMMABLE DRIVER*

POWER	BEAM	LUMEN	CCT		CODE	€
18 W	105°	2550 lm	3000 K	1-10V	270883	230
18 W	105°	2800 lm	4000 K	DALI/Push	270937	260

*Separate switching on of direct and indirect output (available only for on-off versions). Control of the direct and indirect output in synchrony (versions with 1-10V and Push dimming). The dimmable power supplies must be ordered in concomitance with the product and will be included inside the fittings by replacing the on-off power supply. The linear connection is available only for the on-off versions of the products.

FLUO - ASSEMBLY PLANS

SYSTEMS



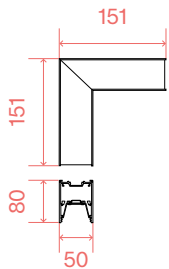
FLUO - MOUNTING KIT

SYSTEMS

	REQUIRED	N' CABLES	CABLES LENGTH	FINISH	CODE	€
KIT SUSPENSION		1	2000 mm	White	277929	32
KIT SUSPENSION	YES	1	2000 mm	Black	277912	32
KIT SUSPENSION	1 Kit x power source	1	5000 mm	White	276342	43
KIT SUSPENSION		1	5000 mm	Black	276335	43
KIT SINGLE CABLE	YES - 1 Kit x 600 mm	1	2000 mm		220826	13
KIT SINGLE CABLE	YES - 1 Kit x 600 mm	1	5000 mm		243665	20
KIT RECESSED	YES - 1 Kit x 600 mm	1			191188	25
KIT SURFACE	YES - 1 Kit x 600 mm	1			191171	25

FLUO - OPTIONAL

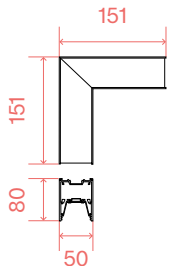
SYSTEMS



CORNER (OPTIONAL - DRIVER ON/OFF INCLUDED - COMPATIBLE WITH WIDE VERSIONS)

POWER	BEAM	LUMEN	CCT	FINISH	CODE	€
8 W	105°	950 lm	3000 K	White	191423	120
8 W	105°	950 lm	3000 K	Black	191430	120
8 W	105°	1000 lm	4000 K	White	191454	120
8 W	105°	1000 lm	4000 K	Black	191461	120

0,580 Kg
0,0023 m³



BLINDED CORNER (OPTIONAL - COMPATIBLE WITH ACCENT VERSIONS)

FINISH	CODE	€
White	191485	65
Black	191492	65

STRUCTURE CONNECTOR (MAXIMUM LENGTH PER POWER SOURCE: 30 METERS)

REQUIRED	CODE	€
YES - 1 Kit x connection	191508	12

0,580 Kg
0,0023 m³

FOX 8W

 **ON-OFF**
 **1-10V/DALI**

PROJECTORS

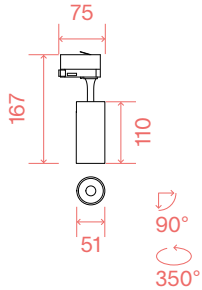
IP20 MacAdam: SDCM 3 CRI: $\geq 80 / \geq 90$ LED LIFE: 30.000 h

 **PHOTO** p. 330

ON/OFF

LED COB BRIDGELUX (DRIVER INCLUDED)

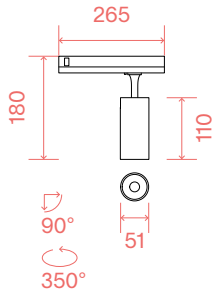
CRI ≥ 80



POWER	BEAM	CONTROL	LUMEN	CCT	FINISH	CODE	€
8 W	41°	On-Off	1050 lm	3000 K	White	250410	49
8 W	41°	On-Off	1050 lm	3000 K	Black	250403	49
8 W	41°	On-Off	1050 lm	3000 K	Brass	283920	49
8 W	41°	On-Off	1100 lm	4000 K	White	271453	49
8 W	41°	On-Off	1100 lm	4000 K	Black	271446	49

1-10V

CRI ≥ 80



POWER	BEAM	CONTROL	LUMEN	CCT	FINISH	CODE	€
8 W	41°	On-Off	850 lm	3000 K	White	285368	49
8 W	41°	On-Off	850 lm	3000 K	Black	285351	49
8 W	41°	On-Off	950 lm	4000 K	White	322339	49
8 W	41°	On-Off	950 lm	4000 K	Black	322322	49
8 W	41°	1-10V	850 lm	3000 K	White	302546	85
8 W	41°	1-10V	850 lm	3000 K	Black	302539	85

0,300 Kg
0,0015 m³

	REQUIRED	BEAM	DRIVER	FINISH	CODE	€
LENS*	NO	23°		Clear	302744	5
SINGLE CONNECTION	NO		On/Off	White	170145	27
SINGLE CONNECTION	NO		On/Off	Black	170152	27

*The optional lens must be ordered in concomitance with the product and will be mounted inside the product as replacement for the default one.

FOX 15W

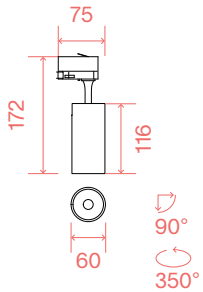
 **ON-OFF**
 **1-10V/DALI**

PROJECTORS

IP20 MacAdam: SDCM 3 CRI: $\geq 80 / \geq 90$ LED LIFE: 30.000 h

ON/OFF

LED COB BRIDGELUX (DRIVER INCLUDED)

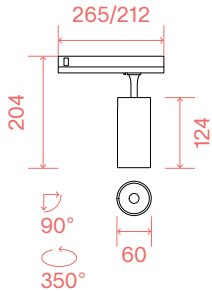


CRI ≥ 80

POWER	BEAM	CONTROL	LUMEN	CCT	FINISH	CODE	€
15 W	41°	On-Off	1700 lm	3000 K	White	250434	55
15 W	41°	On-Off	1700 lm	3000 K	Black	250427	55
15 W	41°	On-Off	1700 lm	3000 K	Brass	283937	55
15 W	41°	On-Off	1750 lm	4000 K	White	267784	55
15 W	41°	On-Off	1750 lm	4000 K	Black	267777	55

1-10V/DALI

CRI ≥ 90



POWER	BEAM	CONTROL	LUMEN	CCT	FINISH	CODE	€
15 W	41°	On-Off	1550 lm	3000 K	White	285382	55
15 W	41°	On-Off	1550 lm	3000 K	Black	285375	55
15 W	41°	On-Off	1600 lm	4000 K	White	322360	55
15 W	41°	On-Off	1600 lm	4000 K	Black	322346	55
15 W	41°	1-10V	1550 lm	3000 K	White	302560	90
15 W	41°	1-10V	1550 lm	3000 K	Black	302553	90
15 W	41°	DALI	1550 lm	3000 K	White	302584	110
15 W	41°	DALI	1550 lm	3000 K	Black	302577	110

0,380 Kg
0,0020 m³

	REQUIRED	BEAM	DRIVER	FINISH	CODE	€
LENS*	NO	15°		Clear	302751	5
SINGLE CONNECTION	NO		On/Off	White	170145	27
SINGLE CONNECTION	NO		On/Off	Black	170152	27

*The optional lens must be ordered in concomitance with the product and will be mounted inside the product as replacement for the default one.

FOX 25W

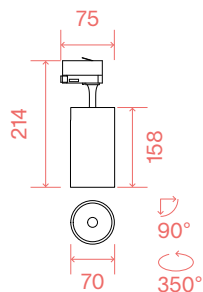
 **ON-OFF**
 **1-10V/DALI**

PROJECTORS

IP20 MacAdam: SDCM 3 CRI: $\geq 80 / \geq 90$ LED LIFE: 30.000 h

ON/OFF

LED COB BRIDGELUX (DRIVER INCLUDED)

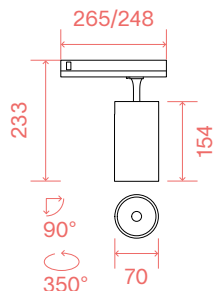


CRI ≥ 80

POWER	BEAM	CONTROL	LUMEN	CCT	FINISH	CODE	€
25 W	35°	On-Off	2950 lm	3000 K	White	250458	60
25 W	35°	On-Off	2950 lm	3000 K	Black	250441	60
25 W	35°	On-Off	2950 lm	3000 K	Brass	283944	60
25 W	35°	On-Off	3050 lm	4000 K	White	267807	60
25 W	35°	On-Off	3050 lm	4000 K	Black	267791	60

1-10V/DALI

CRI ≥ 90



POWER	BEAM	CONTROL	LUMEN	CCT	FINISH	CODE	€
25 W	35°	On-Off	2550 lm	3000 K	White	285405	60
25 W	35°	On-Off	2550 lm	3000 K	Black	285399	60
25 W	35°	On-Off	2700 lm	4000 K	White	322391	60
25 W	35°	On-Off	2700 lm	4000 K	Black	322377	60
25 W	35°	1-10V	2550 lm	3000 K	White	302607	100
25 W	35°	1-10V	2550 lm	3000 K	Black	302591	100
25 W	35°	DALI	2550 lm	3000 K	White	302621	115
25 W	35°	DALI	2550 lm	3000 K	Black	302614	115

0,540 Kg
0,0027 m³

	REQUIRED	BEAM	DRIVER	FINISH	CODE	€
LENS*	NO	15°		Clear	302768	5
SINGLE CONNECTION	NO		On/Off	White	170145	27
SINGLE CONNECTION	NO		On/Off	Black	170152	27

*The optional lens must be ordered in concomitance with the product and will be mounted inside the product as replacement for the default one.

GAME TRIM ROUND

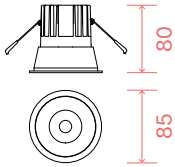
RECESSED LIGHTS



IP20 / 65 UGR:<19 CRI: ≥80 / ≥90 LED LIFE: 50.000 h



PHOTO p. 358



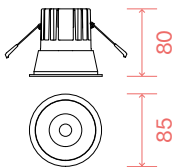
75

0,350 Kg
0,0016 m³

LED COB CREE (DRIVER ON/OFF INCLUDED - CRI ≥80)

WHITE FRAME

POWER	BEAM	LUMEN	CCT	FINISH	CODE	€
11 W	36°	1000 lm	2700 K	White	285429	47
11 W	36°	1100 lm	3000 K	Silver	192284	47
11 W	36°	1100 lm	3000 K	White	192291	47
11 W	36°	1100 lm	3000 K	Black	192277	47
11 W	36°	1100 lm	3000 K	Gold	192307	47
11 W	36°	1250 lm	4000 K	White	267975	47



75

0,350 Kg
0,0016 m³

LED COB CREE (DRIVER ON/OFF INCLUDED - CRI ≥80)

BLACK FRAME

POWER	BEAM	LUMEN	CCT	FINISH	CODE	€
11 W	36°	1000 lm	2700 K	Black	285412	47
11 W	36°	1100 lm	3000 K	Silver	192321	47
11 W	36°	1100 lm	3000 K	White	192338	47
11 W	36°	1100 lm	3000 K	Black	192314	47
11 W	36°	1100 lm	3000 K	Gold	192345	47
11 W	36°	1250 lm	4000 K	Black	267968	47

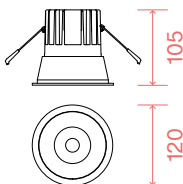
IP65

POWER	BEAM	LUMEN	CCT	FINISH	CODE	€
11 W	36°	1100 lm	3000 K	White	313191	75
11 W	36°	1100 lm	3000 K	Black	327754	75

DIMMABLE DRIVER* (NOT INCLUDED/OPTIONAL)

	POWER	OUTPUT	MEASURE	CODE	€
1-10V/Push	20 W	250 mA	111 x 22 x 52 mm	217253	60
DALI/Push	12 W	250 mA	132 x 20 x 30 mm	202396	60

*The dimmable power supplies must be ordered in concomitance with the product and will be included inside the fittings by replacing the on-off power supply.



110

0,660 Kg
0,0033 m³

LED COB BRIDGELUX (DRIVER ON/OFF INCLUDED - CRI ≥90)

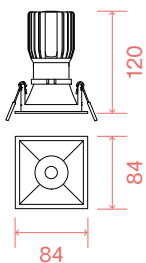
POWER	BEAM	LUMEN	CCT	FINISH	CODE	€
20W	24°	2350 lm	3000 K	White	273174	90
20W	24°	2350 lm	3000 K	Black	273167	90

GAME TRIM SQUARE

RECESSED LIGHTS



IP20 / 65 UGR:<19 CRI:≥80 LED LIFE: 50.000 h



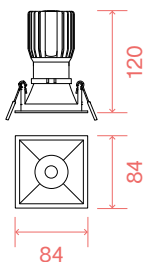
LED COB CREE (DRIVER ON/OFF INCLUDED - CRI ≥80)

WHITE FRAME

POWER	BEAM	LUMEN	CCT	FINISH	CODE	€
11 W	36°	1000 lm	2700 K	White	285443	47
11 W	36°	1100 lm	3000 K	White	192376	47
11 W	36°	1100 lm	3000 K	Black	192352	47

75x75

0,310 Kg
0,0016 m³



LED COB CREE (DRIVER ON/OFF INCLUDED - CRI ≥80)

BLACK FRAME

POWER	BEAM	LUMEN	CCT	FINISH	CODE	€
11 W	36°	1000 lm	2700 K	Black	285436	47
11 W	36°	1100 lm	3000 K	White	192406	47
11 W	36°	1100 lm	3000 K	Black	192383	47

75x75

0,310 Kg
0,0016 m³

IP65

POWER	BEAM	LUMEN	CCT	FINISH	CODE	€
11 W	36°	1100 lm	3000 K	White	313207	75
11 W	36°	1100 lm	3000 K	Black	327761	75

DIMMABLE DRIVER* (NOT INCLUDED/OPTIONAL)

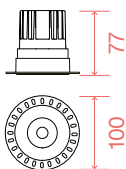
	POWER	OUTPUT	MEASURE	CODE	€
1-10V/Push	20 W	250 mA	111 x 22 x 52 mm	217253	60
DALI/Push	12 W	250 mA	132 x 20 x 30 mm	202396	60

*The dimmable power supplies must be ordered in concomitance with the product and will be included inside the fittings by replacing the on-off power supply.

GAME TRIMLESS

RECESSED LIGHTS

□ IP20 UGR:<19 CRI:≥80 LED LIFE: 50.000 h

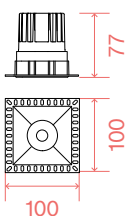


① 75

LED COB CREE (DRIVER ON/OFF INCLUDED - CRI ≥80)

POWER	BEAM	LUMEN	CCT	FINISH	CODE	€
11 W	36°	1100 lm	3000 K	White	319667	50
11 W	36°	1100 lm	3000 K	Black	319650	50

0,300 Kg
0,0011 m³



① 75x75

0,300 Kg
0,0011 m³

LED COB CREE (DRIVER ON/OFF INCLUDED - CRI ≥80)

POWER	BEAM	LUMEN	CCT	FINISH	CODE	€
11 W	36°	1100 lm	3000 K	White	319681	50
11 W	36°	1100 lm	3000 K	Black	319674	50

DIMMABLE DRIVER* (NOT INCLUDED/OPTIONAL)

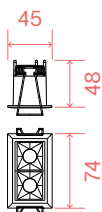
	POWER	OUTPUT	MEASURE	CODE	€
1-10V/Push	20 W	250 mA	111 x 22 x 52 mm	217253	60
DALI/Push	12 W	250 mA	132 x 20 x 30 mm	202396	60

*The dimmable power supplies must be ordered in concomitance with the product and will be included inside the fittings by replacing the on-off power supply.

LIKA TRIM

RECESSED LIGHTS

□ IP20 UGR:<16 CRI: ≥90 LED LIFE: 50.000 h

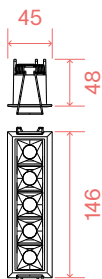


□ 68x37

0,130 Kg
0,0005 m³

LED SMD OSRAM (DRIVER ON/OFF INCLUDED)

POWER	BEAM	LUMEN	CCT	FINISH	CODE	€
6 W	29°	480 lm	3000 K	White + Black	206196	45
6 W	29°	520 lm	4000 K	White + Black	267869	45

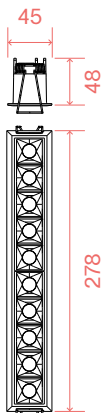


□ 140x37

0,320 Kg
0,0013 m³

LED SMD OSRAM (DRIVER ON/OFF INCLUDED)

POWER	BEAM	LUMEN	CCT	FINISH	CODE	€
12 W	29°	1200 lm	3000 K	White + Black	206219	65
12 W	29°	1250 lm	4000 K	White + Black	267876	65



□ 273x37

0,480 Kg
0,0016 m³

LED SMD OSRAM (DRIVER ON/OFF INCLUDED)

POWER	BEAM	LUMEN	CCT	FINISH	CODE	€
20 W	29°	1750 lm	3000 K	White + Black	206233	110
20 W	29°	1850 lm	4000 K	White + Black	267883	110

DIMMABLE DRIVER* (NOT INCLUDED/OPTIONAL)

MODEL	CONTROL	POWER	OUTPUT	MEASURE	CODE	€
Lika 6 W	DALI	10 W	700 mA	132 x 20 x 30 mm	267982	56
Lika 12 W	DALI	12 W	700 mA	135 x 24 x 72 mm	267999	56
Lika 20 W	DALI/Push	25 W	600 mA	135 x 24 x 72 mm	268002	104

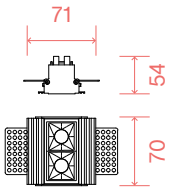
* The dimmable power supplies must be ordered in concomitance with the product and will be included inside the fittings by replacing the on-off power supply.

LIKA TRIMLESS

RECESSED LIGHTS



IP20 UGR:<16 CRI: ≥90 LED LIFE: 50.000 h ↑ PHOTO p. 364

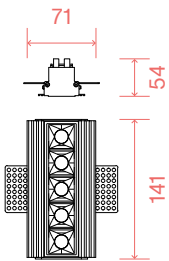


75x70

0,220 Kg
0,0005 m³

LED SMD OSRAM (DRIVER ON/OFF INCLUDED)

POWER	BEAM	LUMEN	CCT	FINISH	CODE	€
6 W	29°	480 lm	3000 K	Black	206202	60
6 W	29°	520 lm	4000 K	Black	267890	60

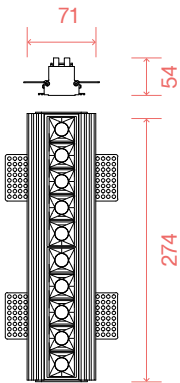


145x70

0,390 Kg
0,0013 m³

LED SMD OSRAM (DRIVER ON/OFF INCLUDED)

POWER	BEAM	LUMEN	CCT	FINISH	CODE	€
12 W	29°	1200 lm	3000 K	Black	206226	95
12 W	29°	1250 lm	4000 K	Black	267906	95



278x70

0,720 Kg
0,0023 m³

LED SMD OSRAM (DRIVER ON/OFF INCLUDED)

POWER	BEAM	LUMEN	CCT	FINISH	CODE	€
20 W	29°	1750 lm	3000 K	Black	206240	151
20 W	29°	1850 lm	4000 K	Black	267913	151

DIMMABLE DRIVER* (NOT INCLUDED/OPTIONAL)

MODEL	CONTROL	POWER	OUTPUT	MEASURE	CODE	€
Lika 6 W	DALI	10 W	700 mA	132 x 20 x 30 mm	267982	56
Lika 12 W	DALI	12 W	700 mA	135 x 24 x 72 mm	267999	56
Lika 20 W	DALI/Push	25 W	600 mA	135 x 24 x 72 mm	268002	104

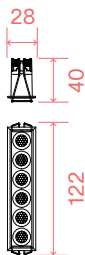
* The dimmable power supplies must be ordered in concomitance with the product and will be included inside the fittings by replacing the on-off power supply.

LIKA SLIM

RECESSED LIGHTS



IP20 UGR:<19 CRI: ≥90 LED LIFE: 30.000 h

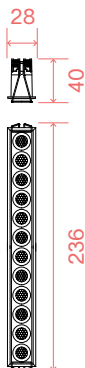


117x23

0,180 Kg
0,0013 m³

LED SMD (DRIVER ON/OFF INCLUDED)

POWER	BEAM	LUMEN	CCT	FINISH	CODE	€
10 W	32°	1000 lm	3000 K	White	327501	65
10 W	32°	1000 lm	3000 K	Black	305813	65



231x23

0,300 Kg
0,0022 m³

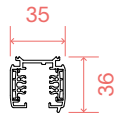
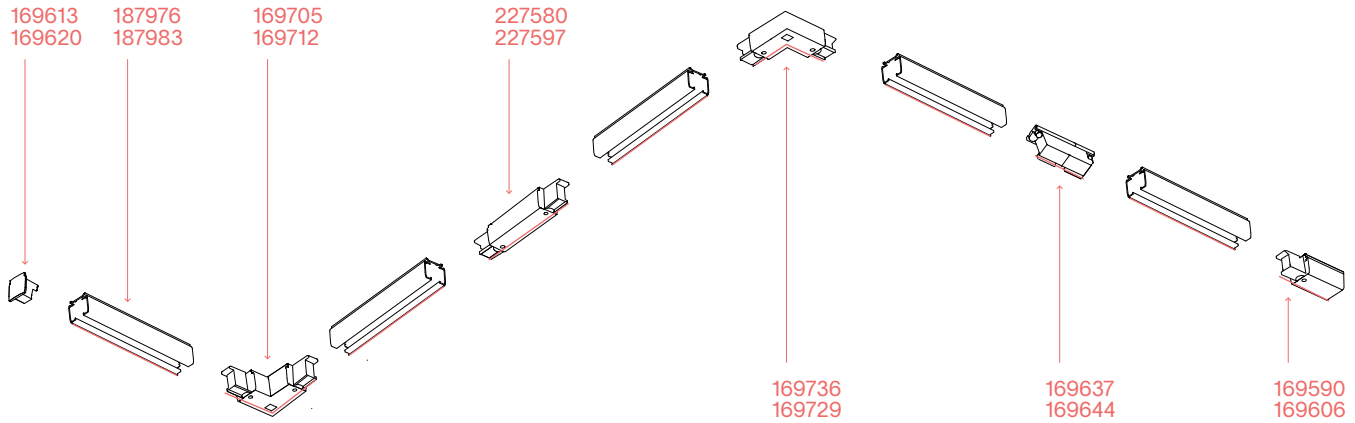
LED SMD (DRIVER ON/OFF INCLUDED)

POWER	BEAM	LUMEN	CCT	FINISH	CODE	€
19 W	32°	2000 lm	3000 K	White	327518	110
19 W	32°	2000 lm	3000 K	Black	305837	110

LINK TRIMLESS ON/OFF

TRACKS

IP20



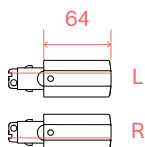
TRACK

LENGTH	WEIGHT	VOLUME	FINISH	CODE	€
1000 mm	0,94 Kg	0,0016 m ³	White	243269	35
1000 mm	0,94 Kg	0,0016 m ³	Black	243252	35
2000 mm	1,72 Kg	0,0074 m ³	White	187976	65
2000 mm	1,72 Kg	0,0074 m ³	Black	187983	65
3000 mm	2,55 Kg	0,0110 m ³	White	187990	105
3000 mm	2,55 Kg	0,0110 m ³	Black	188003	105

	REQUIRED	N° CABLES	CABLES LENGTH	FINISH	CODE	€
KIT SURFACE	YES - 1 Kit x 1000 mm			White	169972	7
KIT SURFACE	YES - 1 Kit x 1000 mm			Black	169989	7
SUSPENSION KIT	YES - 1 Kit x 1000 mm	1	3000 mm	White	242705	16
SUSPENSION KIT	YES - 1 Kit x 1000 mm	1	3000 mm	Black	243283	16
SUSPENSION KIT	YES - 1 Kit x 1000 mm	1	5000 mm	White	243245	18
SUSPENSION KIT	YES - 1 Kit x 1000 mm	1	5000 mm	Black	243238	18
END CAP	YES			White	169613	4
END CAP	YES			Black	169620	4

LINK TRIMLESS ON/OFF

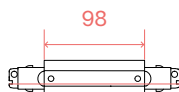
TRACKS



MAIN CONNECTOR END

SIDE	FINISH	CODE	€
L	White	169583	16
L	Black	169576	16
R	White	169590	16
R	Black	169606	16

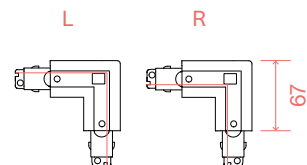
0,060 Kg
0,0002 m³



MAIN CONNECTOR MIDDLE

FINISH	CODE	€
White	227580	26
Black	227597	26

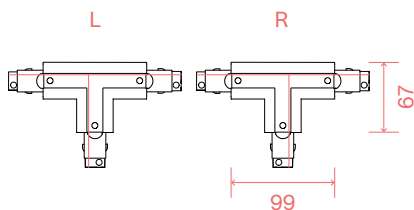
0,120 Kg
0,0004 m³



MAIN CONNECTOR CORNER

SIDE	FINISH	CODE	€
L	White	169705	27
L	Black	169712	27
R	White	169736	27
R	Black	169729	27

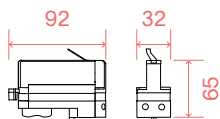
0,110 Kg
0,0005 m³



MAIN CONNECTOR T

SIDE	FINISH	CODE	€
L	White	324289	45
L	Black	324272	45
R	White	324302	45
R	Black	324296	45

0,190 Kg
0,0005 m³



TRACK ADAPTOR

FINISH	CODE	€
White	194257	12
Black	194301	12

0,080 Kg
0,0002 m³



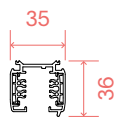
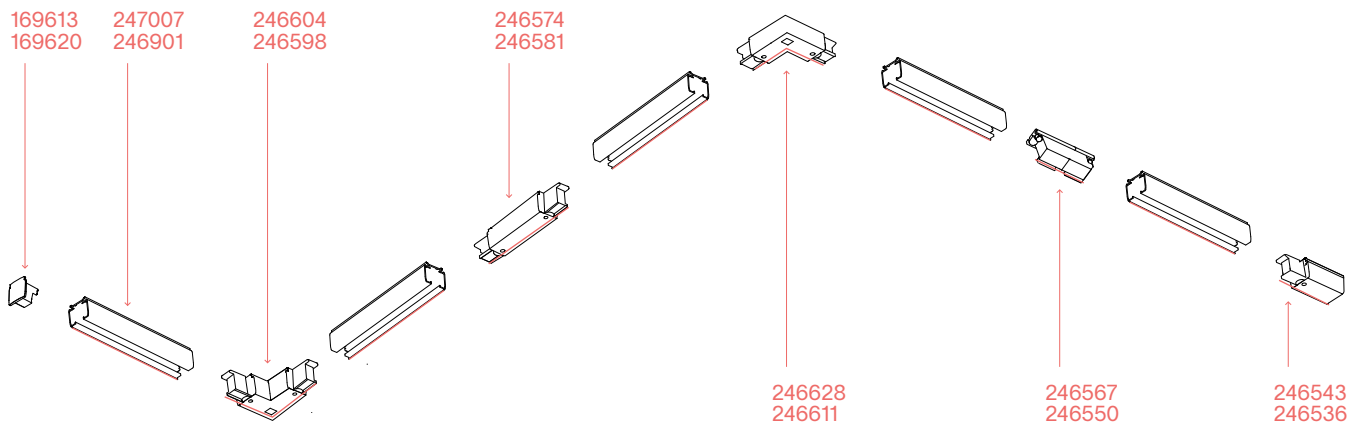
ELECTRIFIED CONNECTOR

FINISH	CODE	€
White	169637	8
Black	169644	8

0,030 Kg
0,0001 m³

LINK TRIMLESS DALI - 1-10V

TRACKS



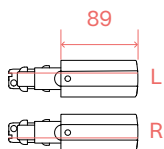
TRACK

LENGTH	WEIGHT	VOLUME	FINISH	CODE	€
1000 mm	0,94 Kg	0,0016 m ³	White	246468	38
1000 mm	0,94 Kg	0,0016 m ³	Black	246451	38
2000 mm	1,93 Kg	0,0032 m ³	White	247007	75
2000 mm	1,93 Kg	0,0032 m ³	Black	246901	75
3000 mm	2,87 Kg	0,0048 m ³	White	247625	115
3000 mm	2,87 Kg	0,0048 m ³	Black	247618	115

	REQUIRED	N° CABLES	CABLES LENGTH	FINISH	CODE	€
KIT SURFACE	YES - 1 Kit x 1000 mm			White	169972	7
KIT SURFACE	YES - 1 Kit x 1000 mm			Black	169989	7
SUSPENSION KIT	YES - 1 Kit x 1000 mm	1	3000 mm	White	242705	16
SUSPENSION KIT	YES - 1 Kit x 1000 mm	1	3000 mm	Black	243283	16
SUSPENSION KIT	YES - 1 Kit x 1000 mm	1	5000 mm	White	243245	18
SUSPENSION KIT	YES - 1 Kit x 1000 mm	1	5000 mm	Black	243238	18
END CAP	YES			White	169613	4
END CAP	YES			Black	169620	4

LINK TRIMLESS DALI - 1-10V

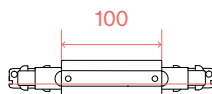
TRACKS



MAIN CONNECTOR END

SIDE	FINISH	CODE	€
L	White	246529	19
L	Black	246512	19
R	White	246543	19
R	Black	246536	19

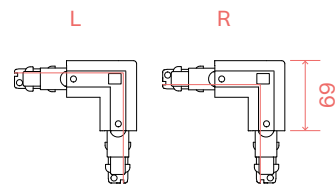
0,079 Kg
0,0002 m³



MAIN CONNECTOR MIDDLE

FINISH	CODE	€
White	246581	31
Black	246574	31

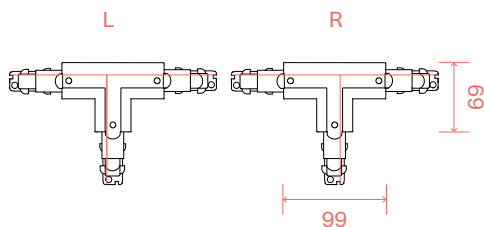
0,129 Kg
0,0004 m³



MAIN CONNECTOR CORNER

SIDE	FINISH	CODE	€
L	White	246604	33
L	Black	246598	33
R	White	246628	33
R	Black	246611	33

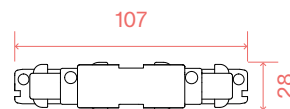
0,130 Kg
0,0006 m³



MAIN CONNECTOR T

SIDE	FINISH	CODE	€
L	White	324326	60
L	Black	324319	60
R	White	324340	60
R	Black	324333	60

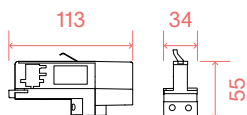
0,200 Kg
0,0007 m³



ELECTRIFIED CONNECTOR

FINISH	CODE	€
White	246567	12
Black	246550	12

0,050 Kg
0,0001 m³



TRACK ADAPTOR

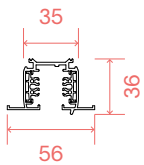
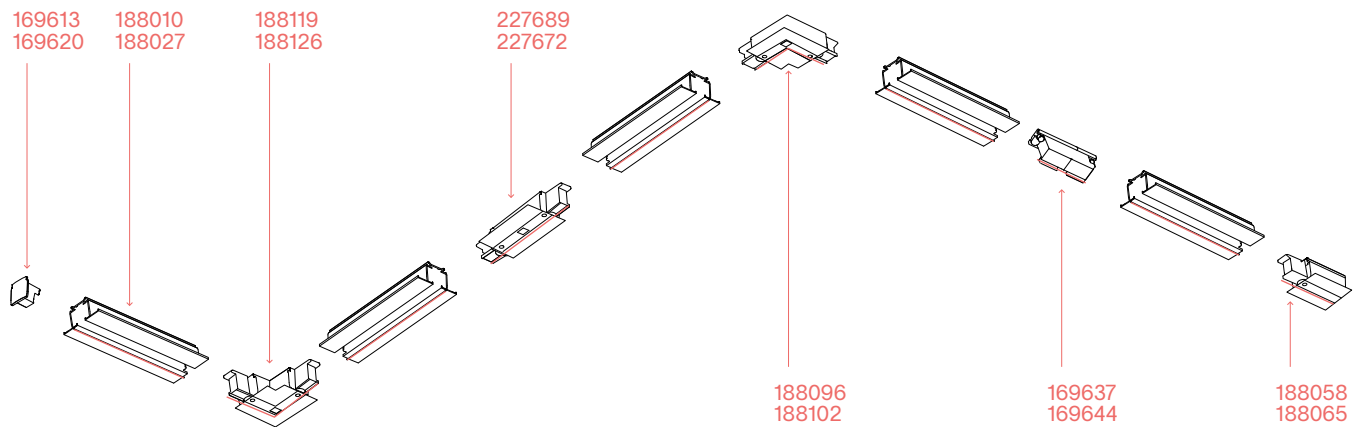
FINISH	CODE	€
White	246505	20
Black	246499	20

0,063 Kg
0,0003 m³

LINK TRIM ON/OFF

TRACKS

IP20



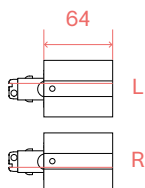
TRACK

LENGTH	WEIGHT	VOLUME	FINISH	CODE	€
2000 mm	1,92 Kg	0,0132 m ³	White	188010	68
2000 mm	1,92 Kg	0,0132 m ³	Black	188027	68

	REQUIRED	FINISH	CODE	€
KIT RECESSED	YES - 1 Kit x 1000 mm	Aluminum	188195	6
END CAP	YES	White	169613	4
END CAP	YES	Black	169620	4

LINK TRIM ON/OFF

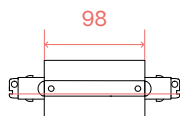
TRACKS



MAIN CONNECTOR END

SIDE	FINISH	CODE	€
L	White	188072	18
L	Black	188089	18
R	White	188058	18
R	Black	188065	18

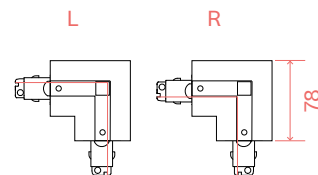
0,070 Kg
0,0002 m³



MAIN CONNECTOR MIDDLE

FINISH	CODE	€
White	227689	29
Black	227672	29

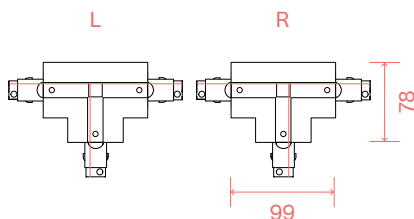
0,130 Kg
0,0004 m³



MAIN CONNECTOR CORNER

SIDE	FINISH	CODE	€
L	White	188119	30
L	Black	188126	30
R	White	188096	30
R	Black	188102	30

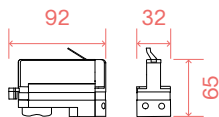
0,120 Kg
0,0006 m³



MAIN CONNECTOR T

SIDE	FINISH	CODE	€
L	White	324364	48
L	Black	324357	48
R	White	324388	48
R	Black	324371	48

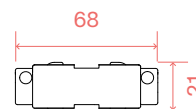
0,200 Kg
0,0051 m³



TRACK ADAPTOR

FINISH	CODE	€
White	194257	12
Black	194301	12

0,080 Kg
0,0002 m³



ELECTRIFIED CONNECTOR

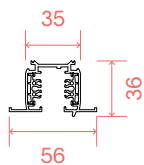
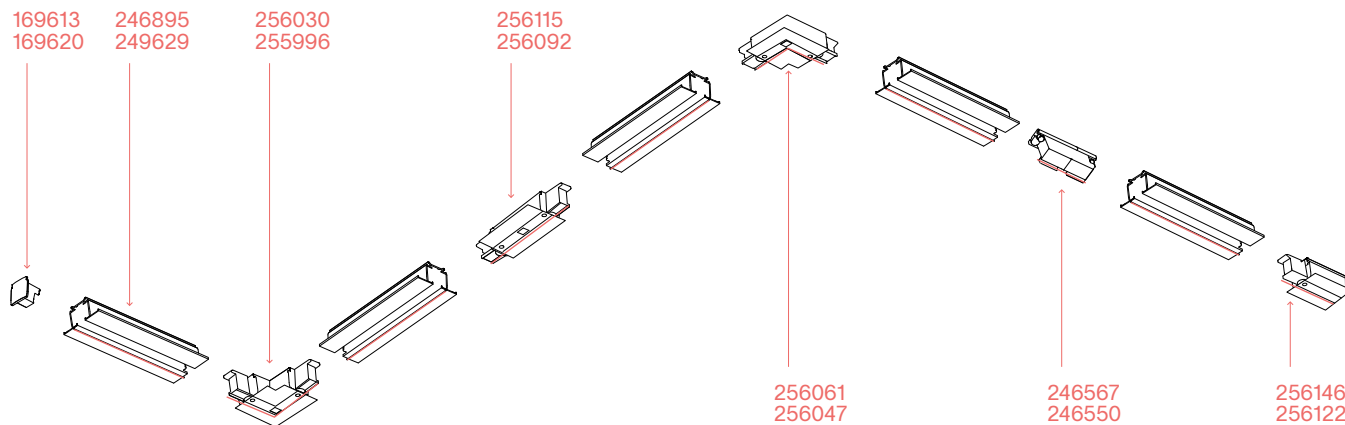
FINISH	CODE	€
White	169637	8
Black	169644	8

0,030 Kg
0,0001 m³

LINK TRIM DALI - 1-10V

TRACKS

IP20



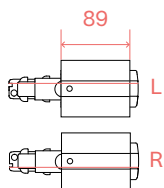
TRACK

LENGTH	WEIGHT	VOLUME	FINISH	CODE	€
2000 mm	2,11 Kg	0,0048 m ³	White	246895	76
2000 mm	2,11 Kg	0,0048 m ³	Black	249629	76

	REQUIRED	FINISH	CODE	€
KIT RECESSED	YES - 1 Kit x 1000 mm	Aluminum	188195	6
END CAP	YES	White	169613	4
END CAP	YES	Black	169620	4

LINK TRIM DALI - 1-10V

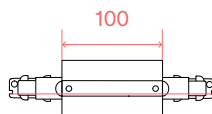
TRACKS



MAIN CONNECTOR END

SIDE	FINISH	CODE	€
L	White	256085	21
L	Black	256078	21
R	White	256146	21
R	Black	256122	21

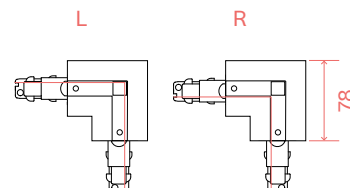
0,089 Kg
0,0004 m³



MAIN CONNECTOR MIDDLE

FINISH	CODE	€
White	256115	34
Black	256092	34

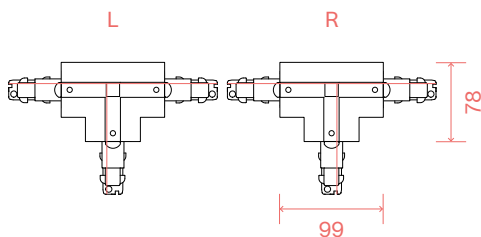
0,150 Kg
0,0005 m³



MAIN CONNECTOR CORNER

SIDE	FINISH	CODE	€
L	White	256030	36
L	Black	255996	36
R	White	256061	36
R	Black	256047	36

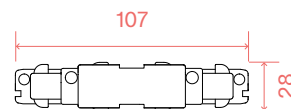
0,150 Kg
0,0006 m³



MAIN CONNECTOR T

SIDE	FINISH	CODE	€
L	White	324401	63
L	Black	324395	63
R	White	324425	63
R	Black	324418	63

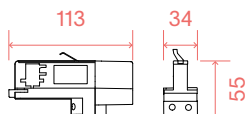
0,200 Kg
0,0051 m³



ELECTRIFIED CONNECTOR

FINISH	CODE	€
White	246567	12
Black	246550	12

0,050 Kg
0,0001 m³



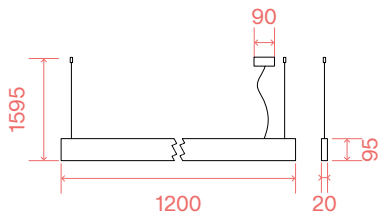
TRACK ADAPTOR

FINISH	CODE	€
White	246505	20
Black	246499	20

0,063 Kg
0,0003 m³



2,550 Kg
0,0158 m³
Cable length
1500 mm



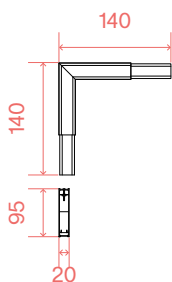
LED SMD (UP-LIGHT INCLUDED - DRIVER 1-10V INCLUDED)

POWER	BEAM	LUMEN	CCT	FINISH	CODE	€
32 W	104°	3450 lm	3000 K	White	241968	220
32 W	104°	3450 lm	3000 K	Black	241975	220
32 W	104°	3600 lm	4000 K	White	268231	220
32 W	104°	3600 lm	4000 K	Black	268217	220

UP-LIGHT INFO

POWER	BEAM	LUMEN	CCT
32 W	104°	3450 lm	3000 K
32 W	104°	3600 lm	4000 K

CORNER (OPTIONAL - UP-LIGHT NOT INCLUDED)

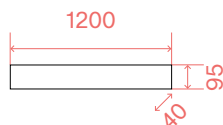


POWER	BEAM	LUMEN	CCT	FINISH	CODE	€
4 W	104°	430 lm	3000 K	White	241999	46
4 W	104°	430 lm	3000 K	Black	242002	46
4 W	104°	450 lm	4000 K	White	268149	46
4 W	104°	450 lm	4000 K	Black	268118	46

STRUCTURE CONNECTOR

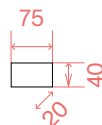
0,260 Kg
0,0023 m³

REQUIRED	CODE	€
YES - 1 Kit x connection	241982	6



1,250 Kg
0,0158 m³
LED 32W
3450/3600 lm

FINISH	LUMEN	CODE	€
White	3000K	233840	210
White	4000K	268095	210
Black	3000K	242019	210
Black	4000K	268071	210



CONNECTOR
(NOT INCLUDED/OPTIONAL)
cod. 233666, € 6

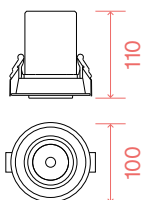


NOVA

RECESSED LIGHTS



IP20 CRI: ≥90 LED LIFE: 50.000 h PHOTO p. 368



① 90

0,550 Kg
0,0016 m³

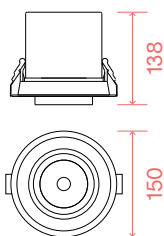
LED COB PHILIPS (DRIVER ON/OFF INCLUDED - UGR <19)

POWER	BEAM	LUMEN	CCT	FINISH	CODE	€
12 W	38°	1000 lm	3000 K	White	248165	75
12 W	38°	1000 lm	3000 K	Black	248189	75
12 W	38°	1100 lm	4000 K	White	267937	75
12 W	38°	1100 lm	4000 K	Black	267920	75

DIMMABLE DRIVER* (NOT INCLUDED/OPTIONAL)

	POWER	OUTPUT	MEASURE	CODE	€
1-10V / Push	15 W	300 mA	111 x 22 x 52 mm	243993	60
DALI/ Push	12 W	300 mA	132 x 20 x 30 mm	243986	60

* The dimmable power supplies must be ordered in concomitance with the product and will be included inside the fittings by replacing the on-off power supply.



① 140

1,160 Kg
0,0039 m³

LED COB PHILIPS (DRIVER ON/OFF INCLUDED - UGR <22)

POWER	BEAM	LUMEN	CCT	FINISH	CODE	€
30 W	38°	3000 lm	3000 K	White	248172	125
30 W	38°	3000 lm	3000 K	Black	248196	125
30 W	38°	3250 lm	4000 K	White	267951	125
30 W	38°	3250 lm	4000 K	Black	267944	125

DIMMABLE DRIVER* (NOT INCLUDED/OPTIONAL)

	POWER	OUTPUT	MEASURE	CODE	€
1-10V / Push	36 W	700 mA	167 x 32 x 41 mm	248370	110
DALI/ Push	36 W	700 mA	135 x 24 x 72 mm	248592	110

* The dimmable power supplies must be ordered in concomitance with the product and will be included inside the fittings by replacing the on-off power supply.

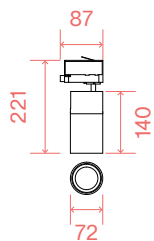
	MODEL	REQUIRED	BEAM	CODE	€
LENS	Nova 12W	NO	15°	244013	6
LENS	Nova 30W	NO	15°	248608	12

QUICK 15W

PROJECTORS



IP20 MacAdam: SDCM 3 CRI: ≥ 80 / ≥ 90 LED LIFE: 50.000 h



0,760 Kg
0,0038 m³

LED COB CITIZEN

CRI ≥ 80

POWER	BEAM	LUMEN	CCT	FINISH	CODE	€
15 W	30°	1800 lm	3000 K	White	222509	145
15 W	30°	1800 lm	3000 K	Black	222523	145
15 W	30°	1950 lm	4000 K	White	222530	145
15 W	30°	1950 lm	4000 K	Black	222547	145

CRI ≥ 90

POWER	BEAM	LUMEN	CCT	FINISH	CODE	€
15 W	30°	1550 lm	3000 K	White	222554	145
15 W	30°	1550 lm	3000 K	Black	222561	145
15 W	30°	1700 lm	4000 K	White	222578	145
15 W	30°	1700 lm	4000 K	Black	222585	145

	REQUIRED	BEAM	FINISH	CODE	€
FILTER HONEYCOMB	NO		Black	222608	9
LENS*	NO	15°	Clear	222592	9
LENS*	NO	45°	Clear	253558	9
SINGLE CONNECTION	NO		White	170145	27
SINGLE CONNECTION	NO		Black	170152	27

* The optional lens must be ordered in concomitance with the product and will be mounted inside the product as replacement for the default one.

QUICK 21W

PROJECTORS

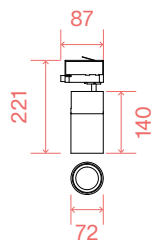


IP20

MacAdam: SDCM 3

CRI: ≥ 80 / ≥ 90

LED LIFE: 50.000 h



0,760 Kg
0,0038 m³

LED COB CITIZEN

CRI ≥ 80

POWER	BEAM	LUMEN	CCT	FINISH	CODE	€
21 W	30°	2450 lm	3000 K	White	247946	155
21 W	30°	2450 lm	3000 K	Black	247939	155
21 W	30°	2700 lm	4000 K	White	247960	155
21 W	30°	2700 lm	4000 K	Black	247953	155

CRI ≥ 90

POWER	BEAM	LUMEN	CCT	FINISH	CODE	€
21 W	30°	2150 lm	3000 K	White	247977	155
21 W	30°	2150 lm	3000 K	Black	225364	155
21 W	30°	2350 lm	4000 K	White	247991	155
21 W	30°	2350 lm	4000 K	Black	247984	155

	REQUIRED	BEAM	FINISH	CODE	€
FILTER HONEYCOMB	NO		Black	222608	9
LENS*	NO	15°	Clear	222592	9
LENS*	NO	45°	Clear	253558	9
SINGLE CONNECTION	NO		White	170145	27
SINGLE CONNECTION	NO		Black	170152	27

* The optional lens must be ordered in concomitance with the product and will be mounted inside the product as replacement for the default one.

QUICK 28W

PROJECTORS



IP20

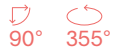
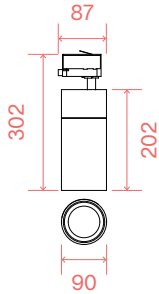
MacAdam: SDCM 3

CRI: ≥ 80 / ≥ 90

LED LIFE: 50.000 h



PHOTO p. 340



1,200 Kg
0,0063 m³

LED COB CITIZEN

CRI ≥ 80

POWER	BEAM	LUMEN	CCT	FINISH	CODE	€
28 W	30°	3550 lm	3000 K	White	222615	185
28 W	30°	3550 lm	3000 K	Black	222622	185
28 W	30°	3800 lm	4000 K	White	222639	185
28 W	30°	3800 lm	4000 K	Black	222646	185

CRI ≥ 90

POWER	BEAM	LUMEN	CCT	FINISH	CODE	€
28 W	30°	3100 lm	3000 K	White	222653	185
28 W	30°	3100 lm	3000 K	Black	222660	185
28 W	30°	3300 lm	4000 K	White	222677	185
28 W	30°	3300 lm	4000 K	Black	222684	185

	REQUIRED	BEAM	FINISH	CODE	€
FILTER HONEYCOMB	NO		Black	222714	10
LENS*	NO	18°	Clear	222691	10
LENS*	NO	45°	Clear	222707	10
SINGLE CONNECTION	NO		White	170145	27
SINGLE CONNECTION	NO		Black	170152	27

* The optional lens must be ordered in concomitance with the product and will be mounted inside the product as replacement for the default one.



STRIP LED SUPPORT

LENGTH	WEIGHT	VOLUME	FINISH	CODE	€
5000 mm	0,35 Kg	0,0234 m ³	Steel	258300	130
5000 mm	0,35 Kg	0,0234 m ³	White	302256	130
5000 mm	0,35 Kg	0,0234 m ³	Black	302263	130



LENGTH	WEIGHT	VOLUME	FINISH	CODE	€
10000 mm	0,45 Kg	0,0029 m ³	Steel	302270	165
10000 mm	0,45 Kg	0,0029 m ³	White	302287	165
10000 mm	0,45 Kg	0,0029 m ³	Black	302294	165

RECOMMENDED STRIP LED AND DRIVER

STRIP LED (SMD 2835 120 LED/M CRI ≥90)

POWER	IP	LUMEN	CCT	LENGTH	CODE	€
15 W/m	IP20	1400 lm/m	2700 K	5000 mm	272498	50
15 W/m	IP20	1450 lm/m	3000 K	5000 mm	272481	50
15 W/m	IP20	1600 lm/m	4000 K	5000 mm	272474	50
15 W/m	IP65	1400 lm/m	3000 K	5000 mm	272504	65
15 W/m	IP65	1480 lm/m	4000 K	5000 mm	287959	65

DRIVER (ON/OFF)

POWER	OUTPUT	CLASS	MEASURE (L X H X W)	DRIVER BOX	CODE	€
30 W	24 Vdc	□	140 x 28 x 45 mm	255 x 55 x 75 mm	124070	17,50
60 W	24 Vdc	□	186 x 33 x 50 mm	255 x 55 x 75 mm	124087	30
150 W	24 Vdc	⊕	268 x 31 x 45 mm	330 x 60 x 80 mm	124117	50

VIRUS

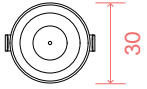
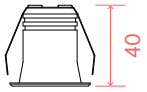
RECESSED LIGHTS



IP20 CRI: ≥90 LED LIFE: 50.000 h



PHOTO p. 374



① 30

0,070 Kg
0,0003 m³

LED SMD OSRAM (DRIVER ON/OFF INCLUDED)

WHITE FRAME

POWER	BEAM	LUMEN	CCT	FINISH	CODE	€
3 W	20°	210 lm	3000 K	White	244808	32
3 W	20°	210 lm	3000 K	Gold	244822	32

LED SMD OSRAM (DRIVER ON/OFF INCLUDED)

BLACK FRAME

POWER	BEAM	LUMEN	CCT	FINISH	CODE	€
3 W	20°	210 lm	3000 K	Black	244846	32
3 W	20°	210 lm	3000 K	Gold	244853	32

AGOS

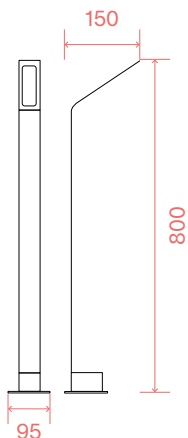
FLOOR



IP54



PHOTO p. 380

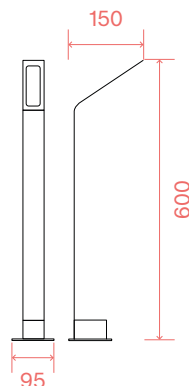


FINISH	CCT	CODE	€
Anthracite	3000 K	254319	140
Anthracite	4000 K	268422	140
Black	3000 K	326733	140
Black	4000 K	326757	140
Coffee	3000 K	326726	140
Coffee	4000 K	326740	140



LED source 3000/4000 K,
25.000 h life.

1,100 Kg
0,0127 m³
LED 6,5W / 670/730 lm



FINISH	CCT	CODE	€
Anthracite	3000 K	254388	120
Anthracite	4000 K	268439	120
Black	3000 K	326696	120
Black	4000 K	326719	120
Coffee	3000 K	326689	120
Coffee	4000 K	326702	120



LED source 3000/4000 K,
25.000 h life.

0,950 Kg
0,0096 m³
LED 6,5W / 670/730 lm

ANDROMEDA

WALL

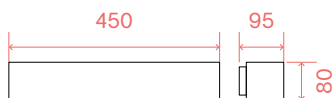


IP55



PHOTO p. 388

1,630 Kg
0,0052 m³
E27 max 2 x 60W

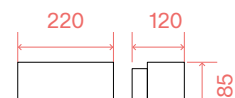


(RECOMMENDED)

LUMEN	CCT	CODE	€
600 lm	4000 K	151960	2

FINISH	CODE	€
White	100364	85
Grey	163543	85
Anthracite	092355	85
Black	100371	85
Coffee	163550	85

1,000 Kg
0,0039 m³
E27 max 1 x 60W



(RECOMMENDED)

LUMEN	CCT	CODE	€
600 lm	4000 K	151960	2

FINISH	CODE	€
White	066868	55
Grey	158822	55
Anthracite	061580	55
Black	061597	55
Coffee	163536	55

DJAMBE

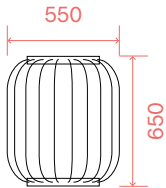
FLOOR



IP44



PHOTO p. 392

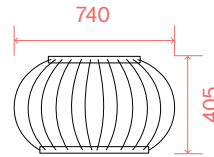


FINISH	CODE	€
Black	293394	397
Coffee	293387	397



LED source 3000 K,
30.000 h life.

6,300 Kg
0,1884 m³
LED 18W / 2300 lm



FINISH	CODE	€
Black	293424	479
Coffee	293417	479



LED source 3000 K,
30.000 h life.

8,000 Kg
0,1654 m³
LED 18W / 2300 lm

GUN

WALL



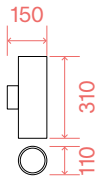
IP54



PHOTO p. 400



IP44

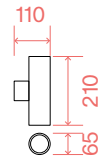


(RECOMMENDED)

LUMEN	CCT	CODE	€
600 lm	4000 K	151960	2

FINISH	CODE	€
White	092300	72
Aluminum	033020	72
Grey	163604	72
Anthracite	236858	72
Black	092317	72
Coffee	163611	72

1,350 Kg
0,0071 m³
E27 max 2 x 60W



(RECOMMENDED)

LUMEN	CCT	CODE	€
430 lm	4000 K	253497	3

FINISH	CODE	€
White	100388	65
Aluminum	033013	65
Grey	163628	65
Anthracite	236841	65
Black	100395	65
Coffee	163635	65

0,720 Kg
0,0024 m³
GU10 max 2 x 35W

CEILING

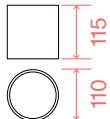


IP44

(RECOMMENDED)

LUMEN	CCT	CODE	€
430 lm	4000 K	253497	3

FINISH	CODE	€
White	122663	54
Aluminum	092324	54
Grey	163642	54
Anthracite	236865	54
Black	122687	54
Coffee	163666	54



0,490 Kg
0,0030 m³
GU10 max 1 x 28W

IPOSTESI

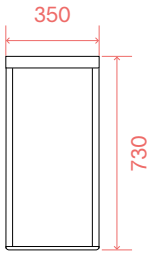
FLOOR



IP44



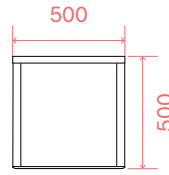
PHOTO p. 408



FINISH	CODE	€
White	282244	335
Black	282251	335

LED source 3000 K, 30.000 h life.

5,100 Kg
0,1041 m³
LED 16W / 1800 lm



FINISH	CODE	€
White	300641	435
Black	300658	435

LED source 3000 K, 30.000 h life.

4,940 Kg
0,1379 m³
LED 16W / 1800 lm

JEDI

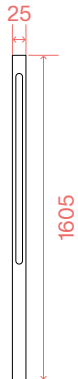
FLOOR



IP65



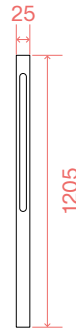
PHOTO p. 414



FINISH	CODE	€
Anthracite	306803	135
Black	293202	135

LED source 3000 K, 30.000 h life.

1,280 Kg
0,0065 m³
LED 25W / 2900 lm



FINISH	CODE	€
Anthracite	306797	110
Black	293196	110

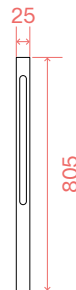
LED source 3000 K, 30.000 h life.

1,030 Kg
0,0150 m³
LED 19W / 2250 lm



FINISH	CODE	€
Anthracite	308227	10
Black	308234	10

Base
Not included
Optional



FINISH	CODE	€
Anthracite	306780	80
Black	293189	80

LED source 3000 K, 30.000 h life.

0,760 Kg
0,0036 m³
LED 12W / 1400 lm

LOLITA

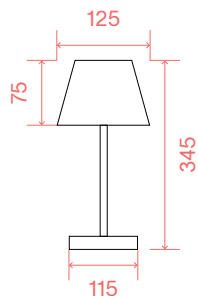
TABLE



IP54



PHOTO p. 420



0,550 Kg
0,0078 m³
LED 2,8W / 250 lm

FINISH	CODE	€
White	286723	55
Grey	286730	55
Black	286716	55
Coffee	286747	55

LED source 3000 K,
25.000 h life.

14 h life.



SIRIO

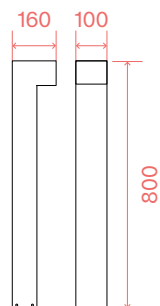
FLOOR



IP44



PHOTO p. 428

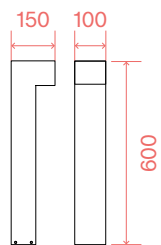


1,880 Kg
0,0181 m³
G9 max 2 x 15W

(RECOMMENDED)

LUMEN	CCT	CODE	€
530 lm	4000 K	307879	6

FINISH	CODE	€
White	115085	165
Grey	246963	165
Anthracite	115061	165
Black	115108	165
Coffee	213262	165



1,550 Kg
0,0136 m³
G9 max 2 x 15W

(RECOMMENDED)

LUMEN	CCT	CODE	€
530 lm	4000 K	307879	6

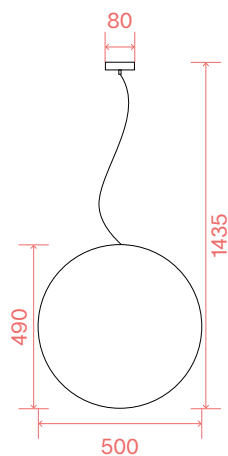
FINISH	CODE	€
White	115092	130
Grey	246970	130
Anthracite	115078	130
Black	115115	130
Coffee	213279	130

SOLE

SUSPENSION



IP44

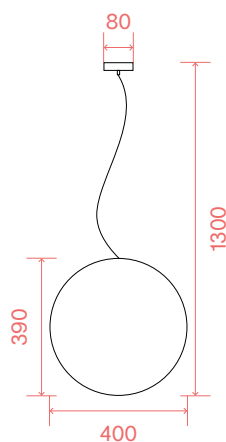


(RECOMMENDED)

LUMEN	CCT	CODE	€
1000 lm	4000 K	151991	2

FINISH	CODE	€
White	136011	180

2,970 Kg
0,1327 m³
E27 max 1 x 60W

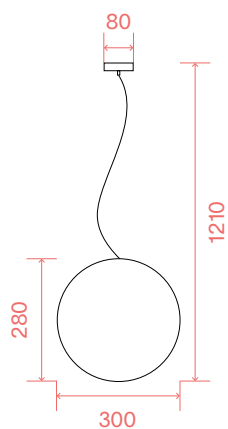


(RECOMMENDED)

LUMEN	CCT	CODE	€
1000 lm	4000 K	151991	2

FINISH	CODE	€
White	136004	110

1,690 Kg
0,0776 m³
E27 max 1 x 60W

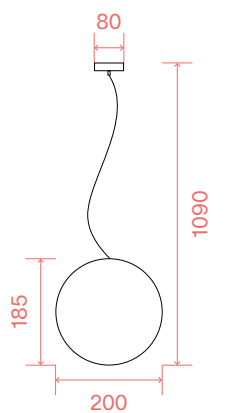


(RECOMMENDED)

LUMEN	CCT	CODE	€
1000 lm	4000 K	151991	2

FINISH	CODE	€
White	135991	95

1,360 Kg
0,0338 m³
E27 max 1 x 60W



(RECOMMENDED)

LUMEN	CCT	CODE	€
600 lm	4000 K	151960	2

FINISH	CODE	€
White	318837	90

1,300 Kg
0,0111 m³
E27 max 1 x 60W

SOLE

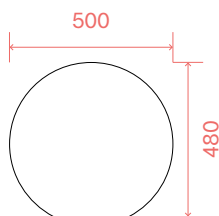
FLOOR



IP44



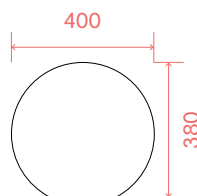
PHOTO p. 436



(RECOMMENDED)

LUMEN	CCT	CODE	€
1000 lm	4000 K	151991	2
FINISH		CODE	€
White		191614	225

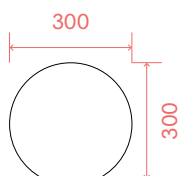
4,500 Kg
0,1460 m³
E27 max 1 x 60W



(RECOMMENDED)

LUMEN	CCT	CODE	€
1000 lm	4000 K	151991	2
FINISH		CODE	€
White		191621	150

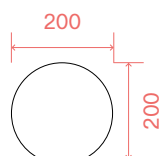
3,900 Kg
0,0741 m³
E27 max 1 x 60W



(RECOMMENDED)

LUMEN	CCT	CODE	€
1000 lm	4000 K	151991	2
FINISH		CODE	€
White		191638	120

2,700 Kg
0,0322 m³
E27 max 1 x 60W



(RECOMMENDED)

LUMEN	CCT	CODE	€
600 lm	4000 K	151960	2
FINISH		CODE	€
White		318820	110

1,200 Kg
0,0139 m³
E27 max 1 x 60W

STARLIGHT

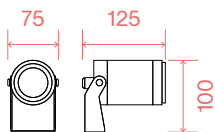
PROJECTORS



MacAdam: SDCM 3 IP68 CRI: ≥80 LED LIFE: 50.000 h



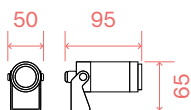
PHOTO p. 442



LED COB BRIDGELUX (DRIVER NOT INCLUDED)

POWER	BEAM	LUMEN	CCT	FINISH	CODE	€
10 W	30°	1000 lm	3000 K	Grigio Scuro	248387	250
10 W	30°	1050 lm	4000 K	Grigio Scuro	245072	250

0,950 Kg
0,0014 m³



LED COB BRIDGELUX (DRIVER NOT INCLUDED)

POWER	BEAM	LUMEN	CCT	FINISH	CODE	€
5,5 W	30°	600 lm	3000 K	Grigio Scuro	248394	120
5,5 W	30°	670 lm	4000 K	Grigio Scuro	245041	120

0,280 Kg
0,0005 m³

OPTIONAL (NOT INCLUDED)

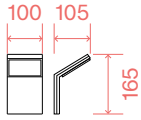
	POWER	FINISH	CODE	€
Visor	5,5 W	Grigio Scuro	245096	34
Visor	10 W	Grigio Scuro	245102	34
IP68 connector		Black	248615	22
Peg		Grigio Scuro	245089	17

ON/OFF DRIVER (NOT INCLUDED/REQUIRED)

OUTPUT	POWER	MISURA	CODE	€
24 Vdc	20 W	118 x 26 x 35 mm	226187	75
24 Vdc	35 W	148 x 30 x 40 mm	226194	80
24 Vdc	100 W	220 x 39 x 68 mm	226200	190
24 Vdc	185 W	220 x 39 x 68 mm	226217	210

STYLE

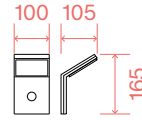
WALL



0,390 Kg
0,0018 m³
LED 9W
1050/1100 lm

FINISH	CCT	CODE	€
White	3000 K	269139	135
White	4000 K	221502	135
Grey	3000 K	322650	135
Grey	4000 K	322643	135
Anthracite	3000 K	246857	135
Anthracite	4000 K	209845	135
Black	3000 K	322636	135
Black	4000 K	322629	135
Coffee	3000 K	322704	135
Coffee	4000 K	322681	135

LED source 3000/4000 K,
30.000 h life.



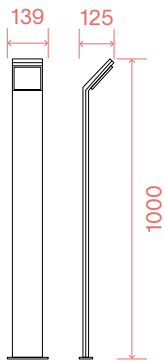
0,400 Kg
0,0018 m³
LED 9,5W
1050/1100 lm

FINISH	CCT	CODE	€
White	3000 K	269146	165
White	4000 K	209852	165
Anthracite	3000 K	246864	165
Anthracite	4000 K	221519	165

LED source 3000/4000 K,
30.000 h life.



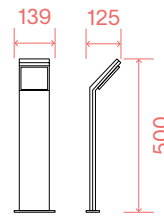
FLOOR



1,680 Kg
0,0239 m³
LED 9W
1050/1100 lm

FINISH	CCT	CODE	€
White	3000 K	318707	190
White	4000 K	322483	190
Grey	3000 K	322384	190
Grey	4000 K	322353	190
Anthracite	3000 K	246871	190
Anthracite	4000 K	209906	190
Black	3000 K	322230	190
Black	4000 K	322216	190
Coffee	3000 K	322452	190
Coffee	4000 K	322438	190

LED source 3000/4000 K,
30.000 h life.



0,020 Kg
0,0122 m³
LED 9W
1050/1100 lm

FINISH	CCT	CODE	€
White	3000 K	318691	145
White	4000 K	322582	145
Grey	3000 K	322551	145
Grey	4000 K	322544	145
Anthracite	3000 K	322612	145
Anthracite	4000 K	322599	145
Black	3000 K	322537	145
Black	4000 K	322506	145
Coffee	3000 K	322575	145
Coffee	4000 K	322568	145

LED source 3000/4000 K,
30.000 h life.

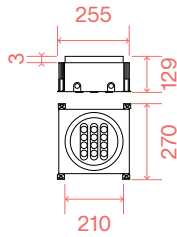
TAURUS ACCENT

RECESSED LIGHTS

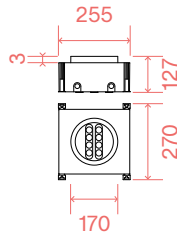


IP67 CRI: ≥80 LED LIFE: 50.000 h (S316)

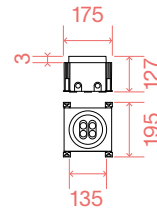
↑ PHOTO p. 454



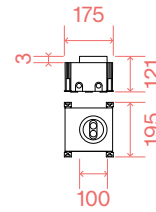
3,500 Kg
0,0242 m³



3,250 Kg
0,0133 m³



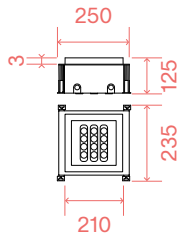
1,980 Kg
0,0071 m³



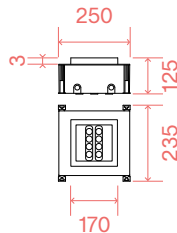
1,460 Kg
0,0129 m³

LED SMD OSRAM (DRIVER ON/OFF INCLUDED)

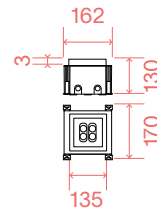
MEASURE	POWER	LUMEN	CCT	FINISH	CODE	€
ø 210	20 W	1900 lm	3000 K	Steel	277035	530
ø 170	14 W	1300 lm	3000 K	Steel	277028	405
ø 135	11 W	840 lm	3000 K	Steel	277011	320
ø 100	6 W	420 lm	3000 K	Steel	277004	210



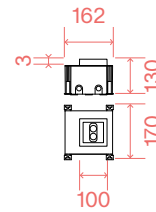
3,000 Kg
0,0168 m³



2,050 Kg
0,0141 m³



1,700 Kg
0,0080 m³





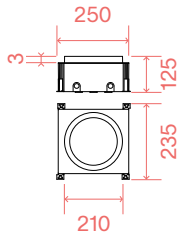
1,100 Kg
0,0067 m³

LED SMD OSRAM (DRIVER ON/OFF INCLUDED)

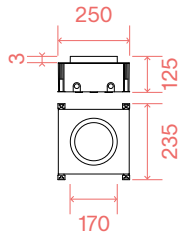
MEASURE	POWER	LUMEN	CCT	FINISH	CODE	€
210	20 W	1900 lm	3000 K	Steel	325712	575
170	14 W	1300 lm	3000 K	Steel	325682	435
135	11 W	840 lm	3000 K	Steel	325651	355
100	6 W	420 lm	3000 K	Steel	325620	235

TAURUS WIDE

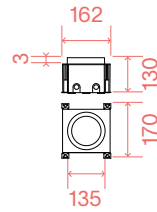
RECESSED LIGHTS  IP67 CRI: ≥80 LED LIFE: 50.000 h 



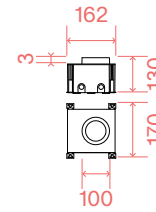
3,000 Kg
0,0183 m³



2,100 Kg
0,0137 m³



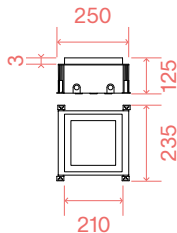
1,400 Kg
0,0091 m³



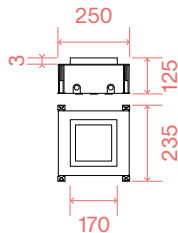
1,100 Kg
0,0077 m³

LED SMD BRIDGELUX (DRIVER ON/OFF INCLUDED)

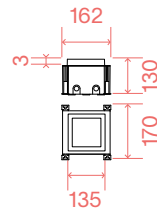
MEASURE	POWER	LUMEN	CCT	FINISH	CODE	€
ø 210	21 W	2700 lm	3000 K	Steel	325729	420
ø 170	16 W	1750 lm	3000 K	Steel	325699	320
ø 135	11 W	1250 lm	3000 K	Steel	325668	275
ø 100	6 W	620 lm	3000 K	Steel	325637	195



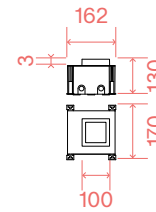
3,000 Kg
0,0168 m³



2,380 Kg
0,0141 m³



1,580 Kg
0,0080 m³



1,100 Kg
0,0067 m³

LED SMD BRIDGELUX (DRIVER ON/OFF INCLUDED)

MEASURE	POWER	LUMEN	CCT	FINISH	CODE	€
210	21 W	2700 lm	3000 K	Steel	325736	450
170	16 W	1750 lm	3000 K	Steel	325705	340
135	11 W	1230 lm	3000 K	Steel	325675	285
100	6 W	620 lm	3000 K	Steel	325644	205

TECHO

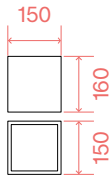
CEILING



IP54



PHOTO p. 460

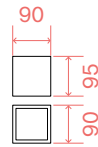


(RECOMMENDED)

LUMEN	CCT	CODE	€
820 lm	4000 K	253398	15

FINISH	CODE	€
White	251523	115
Grey	326887	115
Anthracite	251516	115
Black	251530	115
Coffee	251547	115

1,700 Kg
0,0049 m³
GU10 max 1 x 20W



(RECOMMENDED)

LUMEN	CCT	CODE	€
430 lm	4000 K	253497	3

FINISH	CODE	€
White	251561	64
Grey	326894	64
Anthracite	251554	64
Black	251578	64
Coffee	251592	64

0,600 Kg
0,0012 m³
GU10 max 1 x 20W

TESLA

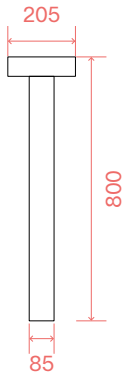
FLOOR



IP44



PHOTO p. 466

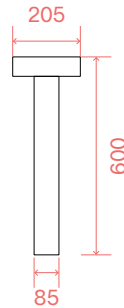


(RECOMMENDED)

LUMEN	CCT	CODE	€
530 lm	4000 K	307879	6

FINISH	CODE	€
White	153179	155
Grey	326931	155
Anthracite	153162	155
Black	316055	155
Coffee	326924	155

3,000 Kg
0,0379 m³
G9 max 4 x 15W



(RECOMMENDED)

LUMEN	CCT	CODE	€
530 lm	4000 K	307879	6

FINISH	CODE	€
White	153209	145
Grey	326900	145
Anthracite	153193	145
Black	326917	145
Coffee	316048	145

2,560 Kg
0,0273 m³
G9 max 4 x 15W

VEGA

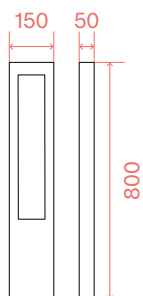
FLOOR



IP44



PHOTO p. 472



1,150 Kg
0,0092 m³
G9 max 1 x 15W

(RECOMMENDED)

LUMEN	CCT	CODE	€
530 lm	4000 K	307879	6

FINISH	CODE	€
White	136035	180
Grey	136042	180
Anthracite	136028	180
Black	136059	180
Coffee	213361	180

Technical icons



Class I Electrical safety guaranteed by main insulation and additional protective conductor (earthing) connected with metal lamp frame. Earthing is obligatory.



Class III Electrical safety guaranteed by very low power supply (less than 50 Volt). Earthing excluded.



Class II Electrical safety guaranteed by main insulation and double or reinforced insulation. Earthing not necessary.



Mark of conformity to European Community Safety regulations.

Symbols



Items with LED lights: very low consumption, highly bright and focused light, strength and durability.



Luminaire with dimmer.



Integrated switch button.



Lamp with integrated USB socket.



Lamp with touch switch: switching on and dimming by touching the base with a finger.



Lamp with rechargeable battery included.



Lamp with presence detector included PIR (Passive InfraRed).



Item made of stainless steel 316.



High-tech product with high quality materials, intended for professional use.

NOTES:

-The indicated prices are public prices VAT excluded.

-Ideal lux s.r.l. reserves the right to make, at any time and without notice, all the changes necessary to improve the quality of the items included in this catalogue. For the most updated features, please check the documentation available on our website (www.ideal-lux.com).

-Our products with Class I and II work with nominal Voltage of 220-240 Vac 50/60 Hz. All our products comply with EU legislation.

-Whenever purchased separately as "optional", the DIMMABLE DRIVER will be already included in the product as replacement for the default on-off driver: only one driver will be supplied.

-The Watt indicated in the catalogue express the NOMINAL power of the lighting fitting including

source and driver, when present. The Lumen measures referred to the lighting fittings with integrated LED source are nominal, namely referred to the source.

We kindly invite you to check photometry files for the actual Lumen of the single lighting fittings. For further information and updates.

-The UGR rate is not a characteristic of the fitting itself, but of the installation. The UGR values reported in this catalogue are calculated taking into consideration an ideal installation and are regrouped into blocks <10 <13 <16 <19 <22. It is recommended to calculate the specific UGR according to your installation.

-The useful life of the LED sources of all the products in the catalogue refers, when it is not differently declared, to the L70B50 value.

Photography: Tiziano Sartorio - tizianosartorio.com

Setup & styling: Alessandro Pasinelli - alessandropasinelli.com

Art direction and graphic design: jekyll & hyde - jeh.it

Pictures: page 5, 7, 150, 286, 350, 378, Stocksy; page 120, iStock;
page 14, Shutterstock; page 196, DTS; page 236, 296, Unsplash.

Agos, Andromeda, Bean, Bento, Birds, Clip, Cover, Delta,
Diesis, Display, Djambe, Dorsale, Dot, Dynamite, Ego, Eos
Equinoxe, Essence, Fade, Filo, Fluo, Fly, Focus, Fox, Frame,
Futura, Game, Gemini, Gun, Ipotesi, Jedi, Lika, Link, Linus,
Lolita, Look, Mapa Bianco, Mint, Mix Up, Moby, Nemo, Nova,
Onion, Oracle Slim, Oz, Perlage, Piano, Pivot, Quick,
Set Up, Sirio, Sole, Spike, Starlight, Style, Taurus, Techo,
Tesi, Tesla, Ultrathin , Vega, Virus, Yoko, Zig Zag.