



InLight

Ένας κόσμος γεμάτος φως

Αφουγκραζόμενοι τις τάσεις της αγοράς, δημιουργήσαμε τον παρόντα κατάλογο, με σκοπό να εμπλουτίσουμε τη συλλογή των προϊόντων μας. Μοντέρνα φωτιστικά αλλά και πιο κλασικά καθώς και λαμπτήρες Led περιέχονται σε αυτόν.

Θα θέλαμε να υπογραμμίσουμε ότι ο κατάλογος αυτός λειτουργεί συμπληρωματικά με τον προηγούμενο και σε καμία περίπτωση δεν τον καταργεί.

Following the market trends, we have created this catalog in order to enrich our product collection. Modern lamps but also more classic ones as well as Led lamps are contained in it.

We would like to underline that **this catalog works in addition to the previous one.**

Track light and accessories



T01801-BL / T01802-BL
page 14



T01701-BL / T01702-BL
page 14



T01301-BL / T01302-BL
page 15



T01401-BL / T01402-BL
page 15



T01501-BL / T01502-BL
page 15



T01601-BL / T01602-BL
page 15



T02501-BL / T02502-BL
page 16



T02301-BL / T02302-BL
page 17



T02401-BL / T02402-BL
page 17



T01901-BL / T01902-BL
page 18



T02001-BL / T02002-BL
page 19



T02101-BL / T02102-BL
page 19



TR006 / TR005
page 21



TC016
page 21



TC017
page 21



TC018
page 21



TD001 / TD002
page 21



TC021
page 21



TC019
page 21



TC020
page 21



T00901-BL / T00902-BL
page 22



T01001-BL / T01002-BL
page 23



T00801-BL / T00802-BL
page 23



TR003-BL / TR004-BL
page 24



T00501-WH / T00502-WH
page 29



T00101-WH / T00102-WH
page 30



T00201-WH / T00202-WH
page 30



T00101-BL / T00102-BL
page 31



T00201-BL / T00202-BL
page 31



T02601-BL / T02602-BL
T02701-BL / T02702-BL
page 32 / 33



T02601-WH / T02602-WH
T02701-WH / T02702-WH
page 32 / 33



TC005-BL
page 34



TC005-WH
page 34



TC008-BL
page 34



TC008-WH
page 34



TR001-BL / TR002-BL
page 34



TC011-BL
page 24



TC012-BL
page 24



TC010-BL
page 24



TC015-BL
page 24



TC009-BL
page 24



TC013-BL
page 24



TR001-WH / TR002-WH
page 34



TC001-BL
page 35



TC001-WH
page 35



TC002-BL
page 35



TC002-WH
page 35



TC003-BL
page 35

Track light and accessories



TC014-BL
page 24



T0110-BL
page 25



T01200-BL
page 25



T00600-BL
page 26



T00700-BL
page 26



T00300-BL
page 26



T00600-WH
page 27



T00700-WH
page 27



T00300-WH
page 27



T00501-BL / T00502-BL
page 28



T00401-BL / T00402-BL
page 28



T00401-WH / T00402-WH
page 29



T00501-WH / T00502-WH
page 29



T00101-WH / T00102-WH
page 30



T00201-WH / T00202-WH
page 30



T00101-BL / T00102-BL
page 31



T00201-BL / T00202-BL
page 31



T02601-BL / T02602-BL
T02701-BL / T02702-BL
page 32 / 33



T02601-WH / T02602-WH
T02701-WH / T02702-WH
page 32 / 33



TC005-BL
page 34



TC005-WH
page 34



TC008-BL
page 34



TC008-WH
page 34



TR001-BL / TR002-BL
page 34

Track light and accessories



TC003-WH
page 35



TC006-BL
page 35



TC006-WH
page 35



TC004
page 35

Linear lights & accessories



6042-180cm,
120cm, 90cm- BL
page 36



6172-180cm,
120cm, 90cm - BL
page 37



L004-BL / L002-BL
page 38



L002-WH
page 38



L001-BL
page 38



L001-WH
page 38



L003-180cm,
120cm, 90cm-BL
page 38



L003-180cm,
120cm, 90cm-BL
page 38



6172-180cm,
120cm, 90cm - WH
page 38

Pendant lights



6171-120-BL
6171-100-BL
page 40



6171-80-BL
6171-60-BL
page 40



6171-120-BL
6171-100-BL
page 41



6171-80-BL
6171-60-BL
page 41



6041-120-BL
6041-100-BL
page 43



6041-80-BL
6041-60-BL
page 43



6045
page 46



6043
page 58



6052-BL
page 59



6057-BL
page 60



6058-BL
page 61



6059-CH
page 63

Pendant lights



6059-GL
page 63



4018-BL
page 65



4018-WH
page 65



4019-GL
page 65



42024-A Golden
42024-B Golden
page 74



42023-A White
42023-B White
page 75



42023-A Black
42023-B Black
page 75



6063
page 81



6062-BL
page 82



6061-BL
page 83



6060-BL
page 83



6064 - BL
page 84



4020 - BL
page 85



4023-BL
page 86



4021-BL
page 87



4022- CH
page 89



4023-CH
page 89



4022- GL
page 90



4023-GL
page 90



4016-4/ROSETTE
page 92



4016-3/ROSETTE
page 92



4016-4/RAIL
page 93



4016-1
page 93



4016-3/RAIL
page 93



6069-12
page 95



6068-4
page 97



6068-8
page 97



6068-12
page 99



4030
page 101



4029B / 4029A
page 102, 103

Pendant lights



4025B / 4025A
page 104



4026B / 4026A
page 105



4027B / 4027A
page 107



4028B / 4028A
page 109



4024-3-BL/ROSETTE
page 110



4024-2-BL/ROSETTE
page 110



4024-BL
page 110



4024-3-BL/RAIL
page 111



4024-2-BL/RAIL
page 111



4024-3-WH/RAIL
page 112



4024-2-WH/RAIL
page 112



4024-3-WH/ROSETTE
page 113



4024-2-WH/ROSETTE
page 113



4024-WH
page 113



4017-BL
page 115



4017-WH
page 115



4036
page 130



4034
page 131



4035
page 132



4038
page 133



4037
page 135

Ceiling Lights



6171-120-BL
6171-100-BL
page 40



6171-80-BL
6171-60-BL
page 40



6171-120-WH
6171-100-WH
page 40



6171-80-WH
6171-60-WH
page 41



6041-120-BL
6041-100-BL
page 43



6041-80-BL
6041-60-BL
page 43

Ceiling Lights



6044
page 44



6047
page 45



6046
page 47



6050-BL
page 49



6051-CH
page 49



6051-GL
page 49



6048-BL
page 51



6049-CH
page 51



6049-GL
page 51



6055-BL
page 52



6056-GL
page 52



6053-BL
page 53



6054-GL
page 53



6066-CH
page 54



6065-BL
page 55



6066-GL
page 55



42027-BL
page 67



42028-CH
page 67



42028-GL
page 67



42016-A / 42016-B
42016-C
page 71



42014
page 71



42015
page 73



42021-A Golden
42021-B Golden
page 76



42020-A Black
42020-B Black
page 76



42020-A White
42020-B White
page 76



42018
page 78



42019
page 79



43030-BL
page 86



43031-CH
page 89



43031-GL
page 91

Spot Lamp



9086-6
page 120



9086-1
page 121



9086-4
page 121



X0010-WH
page 122



X0010-BL
page 122



42025-WH
page 123



42025-BL
page 123



42026-WH
page 123



42026-BL
page 123



X0009-BL
page 124



X0009-CH
page 124



X0009-WH
page 124



X0008-BL
page 125



X0008-CH
page 125



X0008-WH
page 125

Wall Lamp



43034
page 57



43029-A / 43029-B
page 69



43030-BL
page 86



43031-CH
page 88



43031-GL
page 91



43028-BL
page 119



43028-WH
page 119



43418-BL
page 126



43418-WH
page 126



43037-WH
page 127



43037-BL
page 127



43036
page 127

Wall Lamp



43035
page 95



43033
page 129



43032
page 129

Table Lamp



3020
page 56



3019-BL
page 68



3018-BL
page 85



3016-BL
page 87



3017-CH
page 88



3017-GL
page 90



3015-WH
page 117



3015-BL
page 117



3026
page 130



3024
page 131



3025
page 132



3028
page 133



3027
page 135

Floor Lamp



45022
page 57



45019-BL
page 68



45015-BL
page 87



45016-CH
page 89



45016-GL
page 91



45023
page 137

Led Bulbs



7.27.10.01.7
page 136



7.27.08.25.1 /
7.27.08.42.1
page 138



7.27.10.28.1
page 138



7.14.05.20.1
7.14.05.40.1
page 139



7.27.08.23.1
7.27.08.41.1
page 139



7.27.08.24.1
page 139



7.14.06.17.1
page 140



7.14.05.17.2
7.14.05.16.1 \ 7.14.05.17.1
page 140



7.14.06.18.1
page 140



7.14.06.19.1
page 140



7.27.06.13.1
7.27.05.13.1
7.27.05.13.2
page 141



7.27.10.22.1
7.27.10.18.1
page 142



7.27.10.22.2
7.27.10.18.2
page 142



7.27.08.26.1
7.27.10.26.1
7.27.10.26.2
page 143



7.27.08.16.1 / 7.27.08.21.1
7.27.12.21.2 / 7.27.12.21.1
page 143



7.27.08.39.1
page 144



7.27.12.27.1
page 144



7.27.15.14.1
7.27.15.14.2
7.27.15.14.3
page 145

Led Bulbs



7.27.12.03.1
7.27.12.03.2
7.27.12.03.3
page 149



7.10.05.09.1
7.10.05.09.2
7.10.05.09.3
page 150



7.10.08.10.1
7.10.08.10.2
7.10.08.10.3
page 150



7.10.08.09.1
7.10.08.09.2
page 150



7.09.03.09.1
7.09.03.09.2
7.09.03.09.3
page 151



7.09.06.09.1
7.09.06.09.2
7.09.06.09.3
page 151



7.09.08.09.1
7.09.08.09.2
7.09.08.09.3
page 151



7.09.10.09.1
7.09.10.09.2
7.09.10.09.3
page 151

Led Panel & Accessories



2.20.02.1
2.20.02.2 / 2.20.02.3
page 152



2.20.04.1
2.20.04.2
page 152



2.24.04.2 / 2.30.04.2
2.36.04.2 / 2.48.04.2
page 152



2.20.01.1 / 2.20.01.2
2.20.01.3
page 153



2.20.03.1 / 2.20.03.2
2.24.03.2
page 153



2.50.01.2
page 154



7.27.18.14.1
7.27.18.14.2
7.27.18.14.3
page 145



7.27.08.08.1
7.27.08.08.2
7.27.08.08.3
page 146



7.27.18.04.1
7.27.18.04.2
7.27.18.04.3
page 146



7.27.12.44.1
7.27.12.44.2
page 147



7.27.09.43.1
7.27.09.43.2
page 147



7.14.05.14.1
7.14.05.14.2
7.14.05.14.3
page 148



2.48.01.1 / 2.48.01.2
2.48.01.3
page 154



2.48.03.2
page 155



2.48.02.2
page 155



BAPAN 001
page 156



METPAN 020 / METPAN 024
METPAN 030 / METPAN 036
page 156



METPAN 048 /
METPAN 020 DIM
METPAN 048 DIM
page 156



7.14.08.14.1
7.14.08.14.2
7.14.08.14.3
page 148



7.14.05.13.1
7.14.05.13.2
7.14.05.13.3
page 148



7.14.08.13.1
7.14.08.13.2
7.14.08.13.3
page 148



7.27.05.12.1
7.27.05.12.2
7.27.05.12.3
page 149



7.27.08.12.1
7.27.08.12.2
7.27.08.12.3
page 149



7.27.15.04.1
7.27.15.04.2
7.27.15.04.3
page 149



BAPAN 004
BAPAN 005
page 156



BAPAN 002
page 157



BAPAN 003
page 157



BAPAN 006
page 157



BAPAN 007
page 157

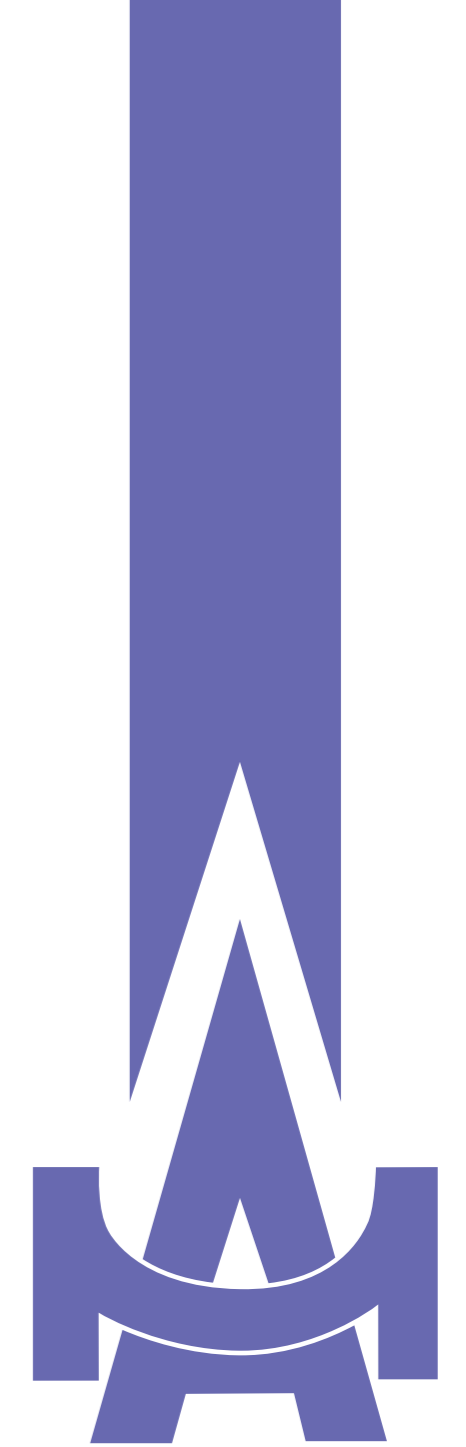

InLight

Ένας κόσμος γεμάτος φως





LED



- Φωτιστικά για μαγνητική ράγα.
- Lighting fixtures for magnetic track.

IP20 |  | NON DIMMABLE



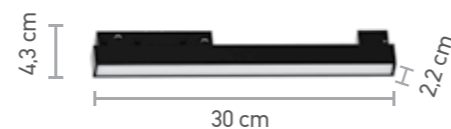

No	T01801-BL	T01802-BL
Power	18W LED	18W LED
Lumens	1100 Lm	1100 Lm
Color temperature	3000 K	4000 K
Dimension	40cm x 4,3cm	40cm x 4,3cm
Color	Black 	Black 
	22-20-50	22-20-50



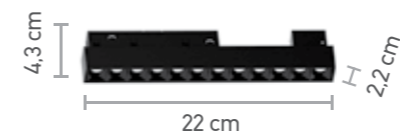

No	T01701-BL	T01702-BL
Power	12W LED	12W LED
Lumens	720 Lm	720 Lm
Color temperature	3000 K	4000 K
Dimension	30cm x 4,3cm	30cm x 4,3cm
Color	Black 	Black 
	22-18-50	22-18-50



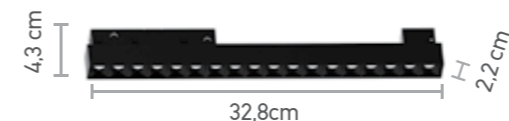

No	T01301-BL	T01302-BL
Power	12W LED	12W LED
Lumens	790 Lm	790 Lm
Color temperature	3000 K	4000 K
Dimension	22cm x 4,3cm	22cm x 4,3cm
Color	Black 	Black 
	22-22-00	22-22-00



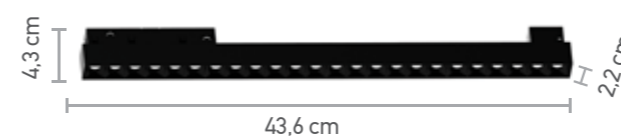

No	T01401-BL	T01402-BL
Power	18W LED	18W LED
Lumens	1350 Lm	1350 Lm
Color temperature	3000 K	4000 K
Dimension	32,8cm x 4,3cm	32,8cm x 4,3cm
Color	Black 	Black 
	22-28-00	22-28-00

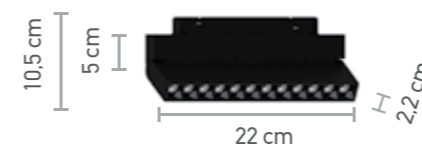

No	T01501-BL	T01502-BL
Power	24W LED	24W LED
Lumens	1800 Lm	1800 Lm
Color temperature	3000 K	4000 K
Dimension	43,6cm x 4,3cm	43,6cm x 4,3cm
Color	Black 	Black 
	22-38-50	22-38-50



No	T01601-BL	T01602-BL
Power	12W LED	12W LED
Lumens	790 Lm	790 Lm
Color temperature	3000 K	4000 K
Dimension	22cm x 10,5cm	22cm x 10,5cm
Color	Black 	Black 
	22-34-50	22-34-50

LED

- Φωτιστικά για μαγνητική ράγα.
- Lighting fixtures for magnetic track.

IP20 |  | NON DIMMABLE





LED

- Κρεμαστά φωτιστικά για μαγνητική ράγα.
- Pendant lights for magnetic.

IP20



35°

NON DIMMABLE

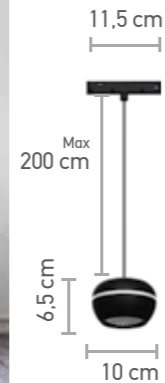
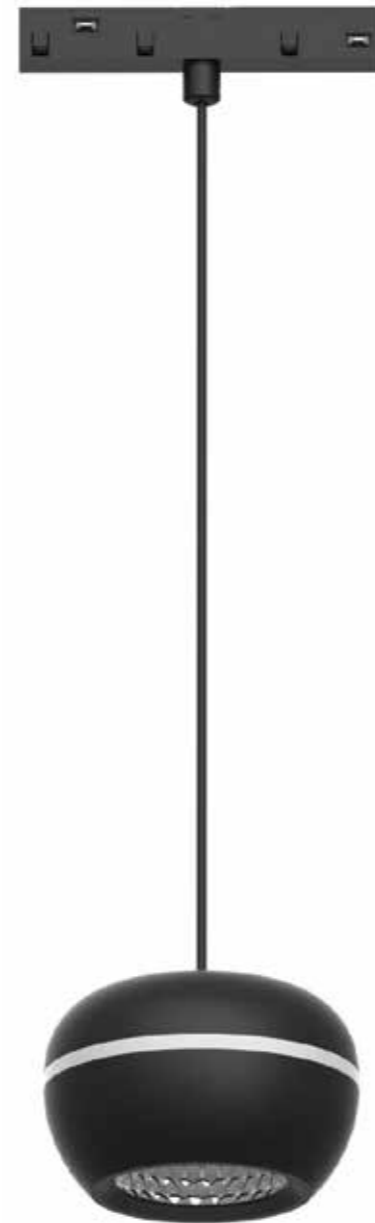

No	T02501-BL	T02502-BL
Power	6W LED	6W LED
Lumens	480 Lm	480 Lm
Color temperature	3000 K	4000 K
Dimension	10cm x 6,5cm	10cm x 6,5cm
Color	Black	Black
	22-36-50	22-36-50

LED

- Κρεμαστά φωτιστικά για μαγνητική ράγα.
- Pendant lights for magnetic.

IP20



35°

NON DIMMABLE

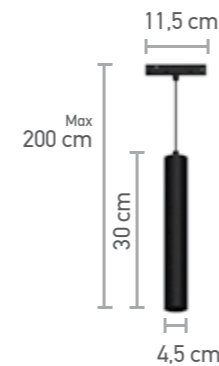

No	T02301-BL	T02302-BL
Power	5W LED	5W LED
Lumens	450 Lm	450 Lm
Color temperature	3000 K	4000 K
Dimension	4,5cm x 30cm	4,5cm x 30cm
Color	Black	Black
	22-41-00	22-41-00

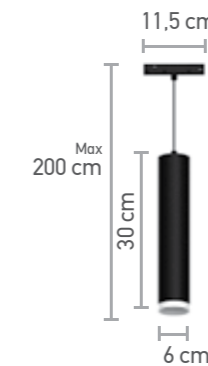

No	T02401-BL	T02402-BL
Power	10W LED	10W LED
Lumens	800Lm	800 Lm
Color temperature	3000 K	4000 K
Dimension	6cm x 30cm	6cm x 30cm
Color	Black	Black
	22-47-00	22-47-00



LED

- Σποτ μαγνητικής ράγας.
- Spot Lights for magnetic track.

IP20



NON DIMMABLE



No	T01901-BL	T01902-BL
Power	10W LED	10W LED
Lumens	800 Lm	800 Lm
Color temperature	3000 K	4000 K
Dimension	14,5cm x 14,5cm	14,5cm x 14,5cm
Color	Black	Black
	22-24-90	22-24-90



LED

- Σποτ μαγνητικής ράγας.
- Spot Lights for magnetic track.

IP20



NON DIMMABLE



No	T02001-BL	T02002-BL
Power	20W LED	20W LED
Lumens	1600 Lm	1600 Lm
Color temperature	3000 K	4000 K
Dimension	16cm x 16,8cm	16cm x 16,8cm
Color	Black	Black
	22-33-40	22-33-40



No	T02101-BL	T02102-BL
Power	10W LED	10W LED
Lumens	800 Lm	800 Lm
Color temperature	3000 K	4000 K
Dimension	8cm x 12,7cm	8cm x 12,7cm
Color	Black	Black
	22-26-50	22-26-50



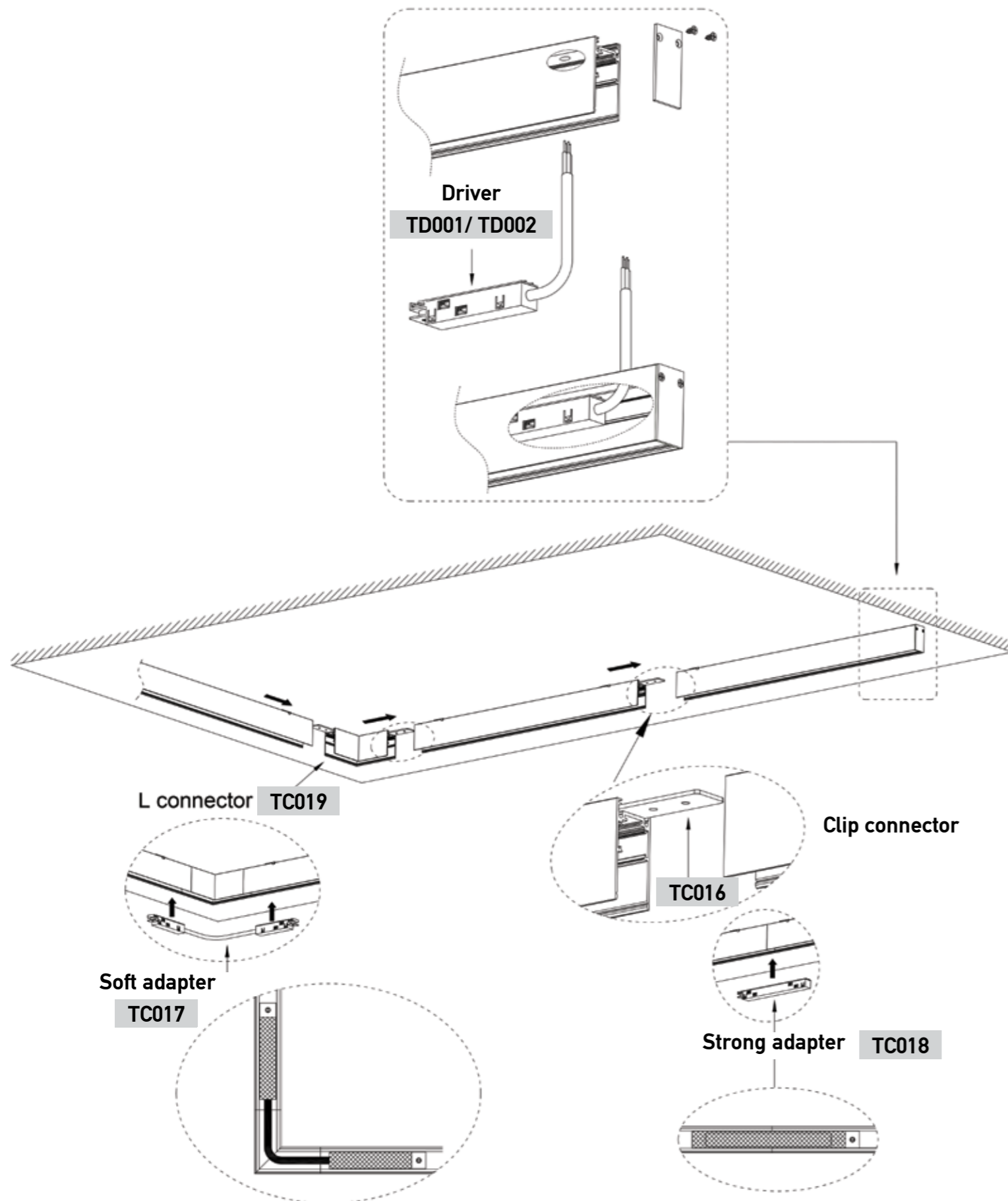

Noted: The soft connector must be on the rails on both sides, not on the L connector, otherwise it will short-circuit and cause a fire.

Noted: The strong connector must be installed in the center of the rails interface otherwise the connection is invalid and may cause a fire.

TR006

Description	Mounted magnetic track 2m with end cap & cover
Color	Black
	22-36-00

TR005

Description	Mounted magnetic track 1m with end cap & cover
Color	Black
	22-18-00

TC016

Description	Clip connector
Color	Black
	22-01-50

TC017

Description	Soft connector adapter
Color	Black
	22-09-00

TC018

Description	Strong connector adapter
Color	Black
	22-08-00

TD001

Power	100W
Supply	48V driver
Color	Black
	22-38-00

TD002

Power	200W
Supply	48V driver
Color	Black
	22-59-00

TC021

Description	Wire ropes for hanging rails 2 meters long set of 2 pcs
	22-05-20

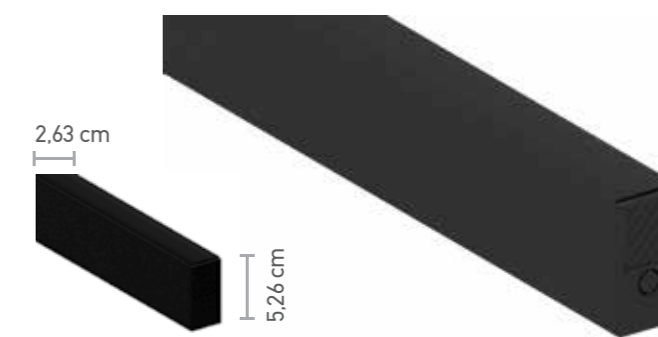

- Μαγνητικές ράγες και εξαρτήματα για μαγνητικές ράγες.
- Magnetic track & accessories for magnetic tracks.



TC019

Description	Connector "L" shape with 2pcs fixed clips
Color	Black
	22-07-50

TC020

Description	Internal connector (between ceiling and wall) with 2pcs fixed clips
Color	Black
	22-08-50



3Phase - 4wires

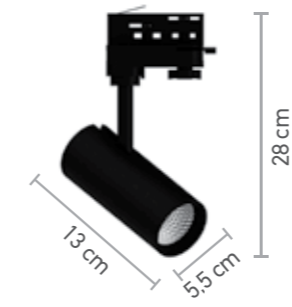

No	T01001-BL	T01002-BL
Power	10W LED	10W LED
Lumens	850 Lm	850 Lm
Color temperature	3000 K	4000 K
Dimension	10cm x 15,5cm	10cm x 15,5cm
Color	Black	Black
	22-25-90	22-25-90

LED
 - Σποτ τριφασικής ράγας.
 - Three phase spot Lights.

35° | 170V / 265V | IP20 | NON DIMMABLE



INLIGHT

3Phase - 4wires

LED
 - Σποτ τριφασικής ράγας.
 - Three phase spot Lights.

35° | 170V / 265V | IP20 | NON DIMMABLE



No	T00901-BL	T00902-BL
Power	30W LED	30W LED
Lumens	2500 Lm	2500 Lm
Color temperature	3000 K	4000 K
Dimension	10cm x 28cm	10cm x 28cm
Color	Black	Black
	22-29-60	22-29-60



No	T00801-BL	T00802-BL
Power	30W LED	30W LED
Lumens	850 Lm	850 Lm
Color temperature	3000 K	4000 K
Dimension	10cm x 20cm	10cm x 20cm
Color	Black	Black
	22-41-60	22-41-60



- Τριφασική ράγα.
- 3phase - 4wires track.



- Εξαρτήματα για τριφασική ράγα.
- Accessories for three phase track.



No TC009-BL	
Description	Connector Straight
Color	Black
22-05-50	

No TC013-BL	
Description	Connector Shape "T"
Color	Black
22-13-60	

3Phase - 4wires

No	TR003-BL	TR004-BL
Description	1m track with power feed and end cap	2m track with power feed and end cap
Color	Black	Black
22-24-00		22-46-60

No TC011-BL	
Description	Connector corner
Color	Black
22-09-00	

No TC012-BL	
Description	Connector flex corner
Color	Black
22-15-50	

No TC010-BL	
Description	Connector Straight
Color	Black
22-09-00	

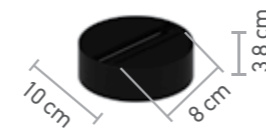

No TC015-BL	
Description	Connector Straight base for track lights
Color	Black
22-10-00	



No TC014	
Description	Wire rops for hanging rails 2m long set 2 pcs
Color	Black
22-09-80	

- Σποτ τριφασικής ράγας.
- Three phase spot Lights

3Phase - 4wires

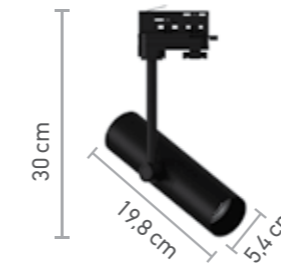

No T01100-BL	
Bulb	1xGU10
Dimension	5,4cm x 30cm
Color	Black
22-26-30	

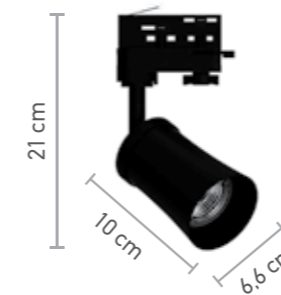

No T01200-BL	
Bulb	1xGU10
Dimension	6,6cm x 21cm
Color	Black
22-18-50	



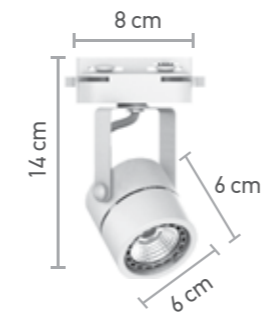

No T00600-WH	
Bulb	1xGU10
Dimension	8cm x 14cm
Color	White
22-08-50	



- Σποτ μονοφασικής ράγας.
- Single phase spot Lights.

GU10 | IP20

1Phase

1Phase

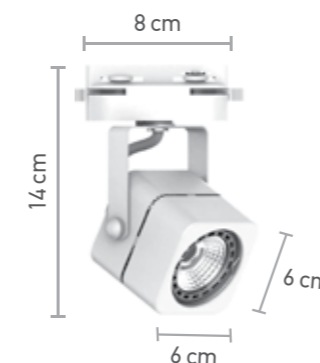

No T00700-WH	
Bulb	1xGU10
Dimension	8cm x 14cm
Color	White
22-08-50	



No T00600-BL	
Bulb	1xGU10
Dimension	8cm x 14cm
Color	Black
22-08-50	

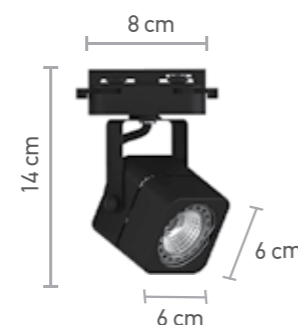

No T00700-BL	
Bulb	1xGU10
Dimension	8cm x 14cm
Color	Black
22-08-50	



No T00300-BL	
Bulb	1xGU10
Dimension	5,6cm x 19cm
Color	Black
22-12-80	



No T00300-WH	
Bulb	1xGU10
Dimension	5,6cm x 25cm
Color	White
22-12-80	





LED

- Σποτ μονοφασικής ράγας.
- Single phase spot Lights.

IP20 | 170V
265V



NON
DIMMABLE

1Phase



No	T00501-BL	T00502-BL
Power	10W LED	10W LED
Lumens	800 Lm	800 Lm
Color temperature	3000 K	4000 K
Dimension	5,5cm x 10,5cm	5,5cm x 10,5cm
Color	Black	Black
	22-20-10	22-20-10



No	T00401-BL	T00402-BL
Power	20W LED	20W LED
Lumens	1600 Lm	1600 Lm
Color temperature	3000 K	4000 K
Dimension	7cm x17cm	7cm x17cm
Color	Black	Black
	22-27-20	22-27-20



No	T00401-WH	T00402-WH
Power	20W LED	20W LED
Lumens	1600 Lm	1600 Lm
Color temperature	3000 K	4000 K
Dimension	7cm x 17cm	7cm x 17cm
Color	White	White
	22-27-20	22-27-20

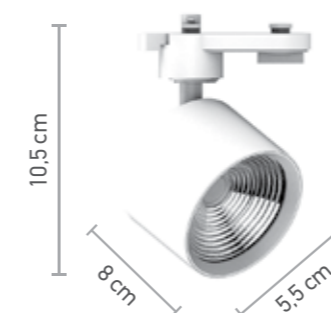

No	T00501-WH	T00502-WH
Power	10W LED	10W LED
Lumens	800 Lm	800 Lm
Color temperature	3000 K	4000 K
Dimension	5,5cm x 10,5cm	5,5cm x 10,5cm
Color	White	White
	22-20-10	22-20-10

1Phase

LED

- Σποτ μονοφασικής ράγας.
- Single phase spot Lights

IP20 | 170V
265V



NON
DIMMABLE



1Phase

LED

- Σποτ μονοφασικής ράγας.
- Single phase spot Lights.

	170V 265V	IP20	NON DIMMABLE
--	----------------------------	-------------	-------------------------------



No	T00101-WH	T00102-WH
Power	30W LED	30W LED
Lumens	2500 Lm	2500 Lm
Color temperature	3000 K	4000 K
Dimension	15,5cm x 23cm	15,5cm x 23cm
Color	White	White
	22-33-50	22-33-50

1Phase

LED

- Σποτ μονοφασικής ράγας.
- Single phase spot Lights.

	170V 265V	IP20	NON DIMMABLE
---	----------------------------	-------------	-------------------------------



No	T00101-BL	T00102-BL
Power	30W LED	30W LED
Lumens	2500 Lm	2500 Lm
Color temperature	3000 K	4000 K
Dimension	15,5cm x 23cm	15,5cm x 23cm
Color	Black	Black
	22-33-50	22-33-50

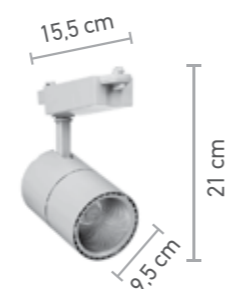

No	T00201-WH	T00202-WH
Power	30W LED	30W LED
Lumens	2500 Lm	2500 Lm
Color temperature	3000 K	4000 K
Dimension	15,5cm x 21cm	15,5cm x 21cm
Color	White	White
	22-37-60	22-37-60



No	T00201-BL	T00202-BL
Power	30W LED	30W LED
Lumens	2500 Lm	2500 Lm
Color temperature	3000 K	4000 K
Dimension	15,5cm x 21cm	15,5cm x 21cm
Color	Black	Black
	22-37-60	22-37-60





1Phase

LED
 - Γραμμικό φωτιστικό μονοφασικής ράγας.
 - Linear Light for single phase track

110° | 170V / 265V | IP20 | NON DIMMABLE

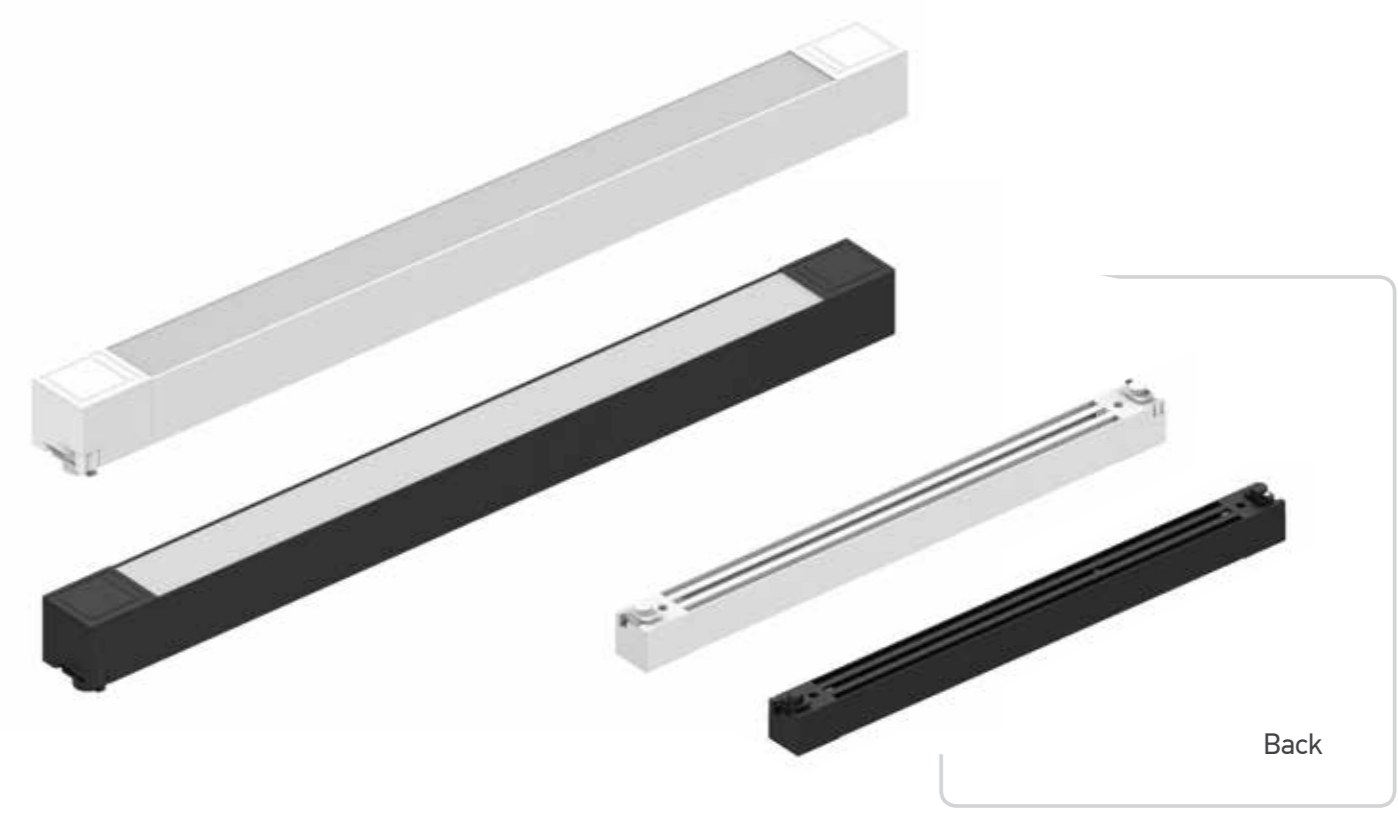

Back

1Phase

LED
 - Γραμμικό φωτιστικό μονοφασικής ράγας.
 - Linear Light for single phase track

110° | 170V / 265V | IP20 | NON DIMMABLE

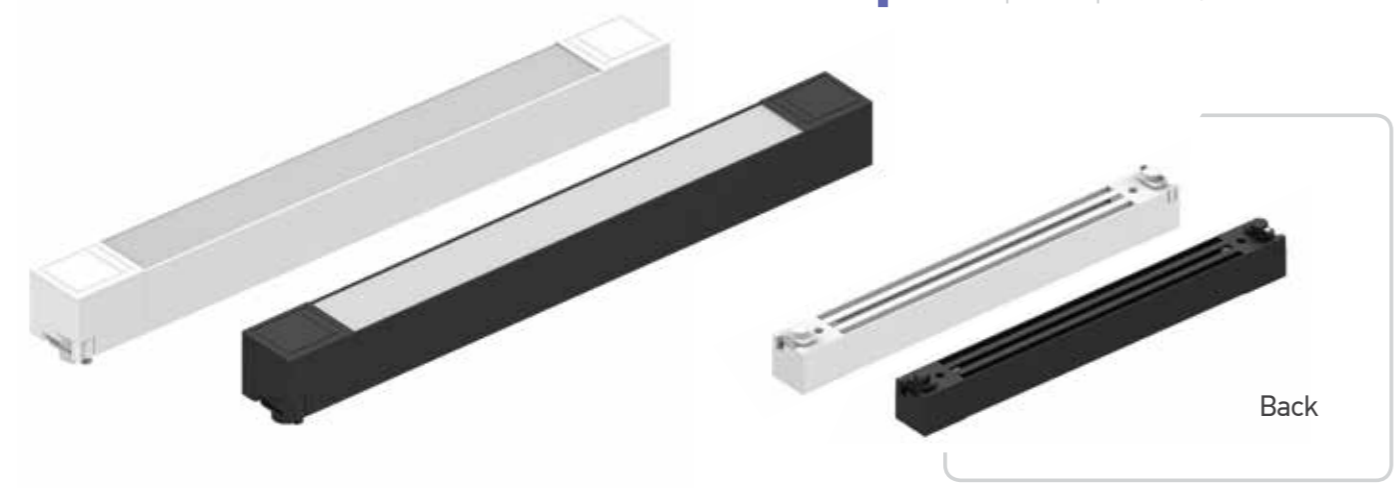

Back

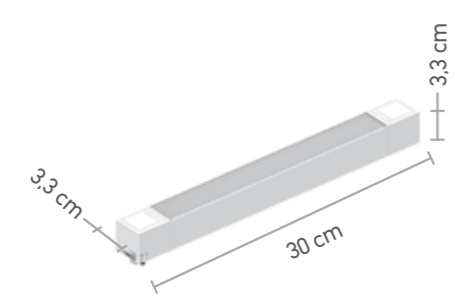

No	T02601-BL	T02602-BL	T02601-WH	T02602-WH
Power	20W LED	20W LED	20W LED	20W LED
Lumens	1200 Lm	1200 Lm	1200 Lm	1200 Lm
Color temperature	3000 K	4000 K	3000 K	4000 K
Dimension	30cm x 3,3cm	30cm x 3,3cm	30cm x 3,3cm	30cm x 3,3cm
Color	Black	Black	White	White
	22-15-00	22-15-00	22-15-00	22-15-00

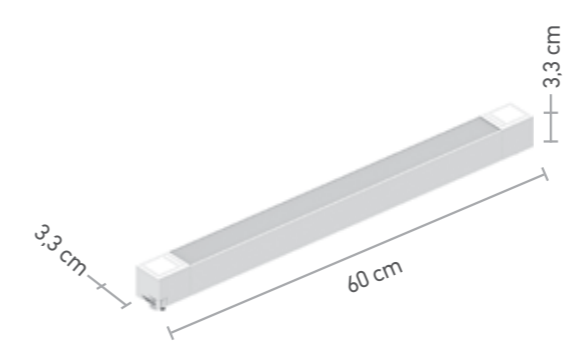

No	T02701-BL	T02702-BL	T02701-WH	T02702-WH
Power	35W LED	35W LED	35W LED	35W LED
Lumens	2100 Lm	2100 Lm	2100 Lm	2100 Lm
Color temperature	3000 K	4000 K	3000 K	4000 K
Dimension	60cm x 3,3cm	60cm x 3,3cm	60cm x 3,3cm	60cm x 3,3cm
Color	Black	Black	White	White
	22-22-00	22-22-00	22-22-00	22-22-00

- Εξαρτήματα για μονοφασική ράγα.
- Accessories for single phase track.

1Phase



No TC005-BL	
Description	Connector for luminaires on a rail
Color	Black
22-01-70	



No TC005-WH	
Description	Connector for luminaires on a rail
Color	White
22-01-70	

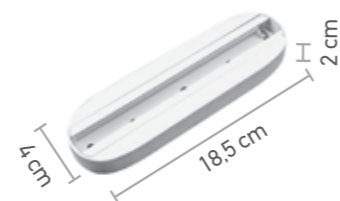

No	TC008-BL	TC008-WH
Description	Base for track lights	Base for track lights
Color	Black	White
	22-03-60	22-03-60

Μονοφασική ράγα
Single phase track

No	TR001-BL	TR002-BL	TR001-WH	TR002-WH
Description	1m track with power feed and end cap	2m track with power feed and end cap	1m track with power feed and end cap	2m track with power feed and end cap
Color	Black	Black	White	White
	22-05-80	22-10-20	22-05-80	22-10-20

1Phase

- Εξαρτήματα για μονοφασική ράγα.
- Accessories for single phase track



No	TC001-BL	TC001-WH
Description	Connector Straight	Connector Straight
Color	Black	White
	22-02-10	22-02-10



No	TC002-BL	TC002-WH
Description	Connector Corner	Connector Corner
Color	Black	White
	22-02-10	22-02-10



No	TC003-BL	TC003-WH
Description	Connector Shape "T"	Connector Shape "T"
Color	Black	White
	22-02-80	22-02-80



No	TC006-BL	TC006-WH
Description	Connector Shape "+"	Connector Shape "+"
Color	Black	White
	22-03-60	22-03-60



No TC004	
Description	Wire ropes for hanging rails 1,5m long
22-05-40	



LED

- Γραμμικό φωτιστικό από αλουμίνιο. Υπάρχει δυνατότητα τοποθέτησης ως κρεμαστό φωτιστικό ή φωτιστικό οροφής.
- Linear Led aluminum light. Can be installed as a pendant lamp or ceiling light.

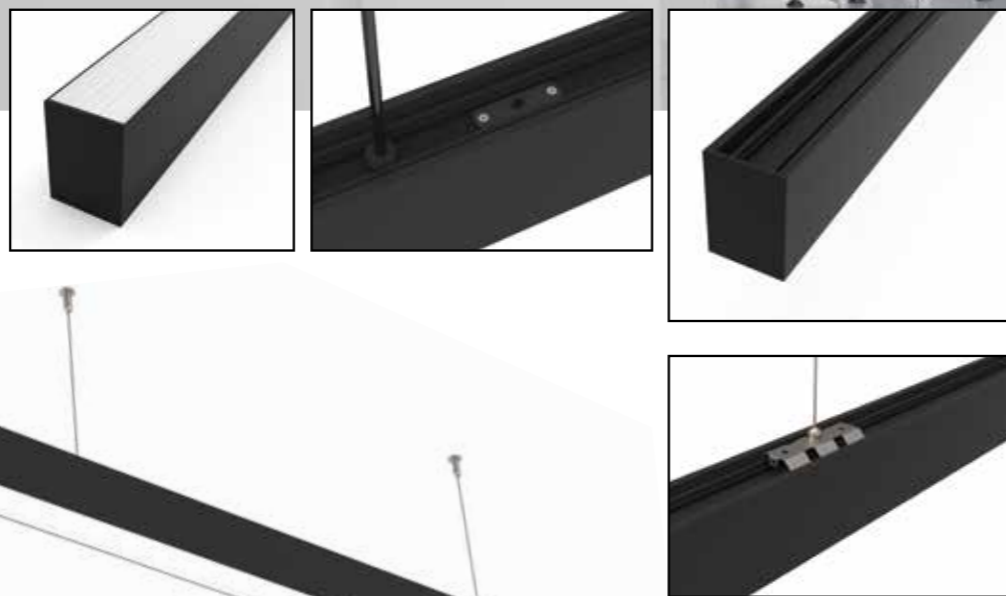

IP20 | 3000K | NON DIMMABLE

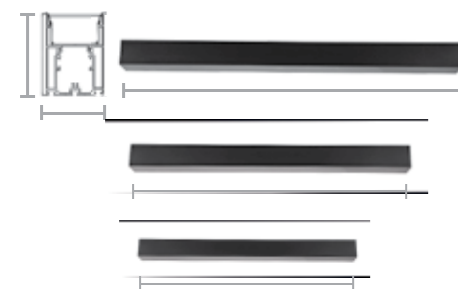

No	6042-180-BL	6042-120-BL	6042-90-BL
Power	50W LED	40W LED	30W LED
Lumens	4000 Lm	3200 Lm	2400 Lm
Color temperature	3000 K	3000 K	3000 K
Material	Aluminum	Aluminum	Aluminum
Dimension	180cm	120cm	90cm
Color	Black	Black	Black
	22-160-00	22-125-00	22-100-00

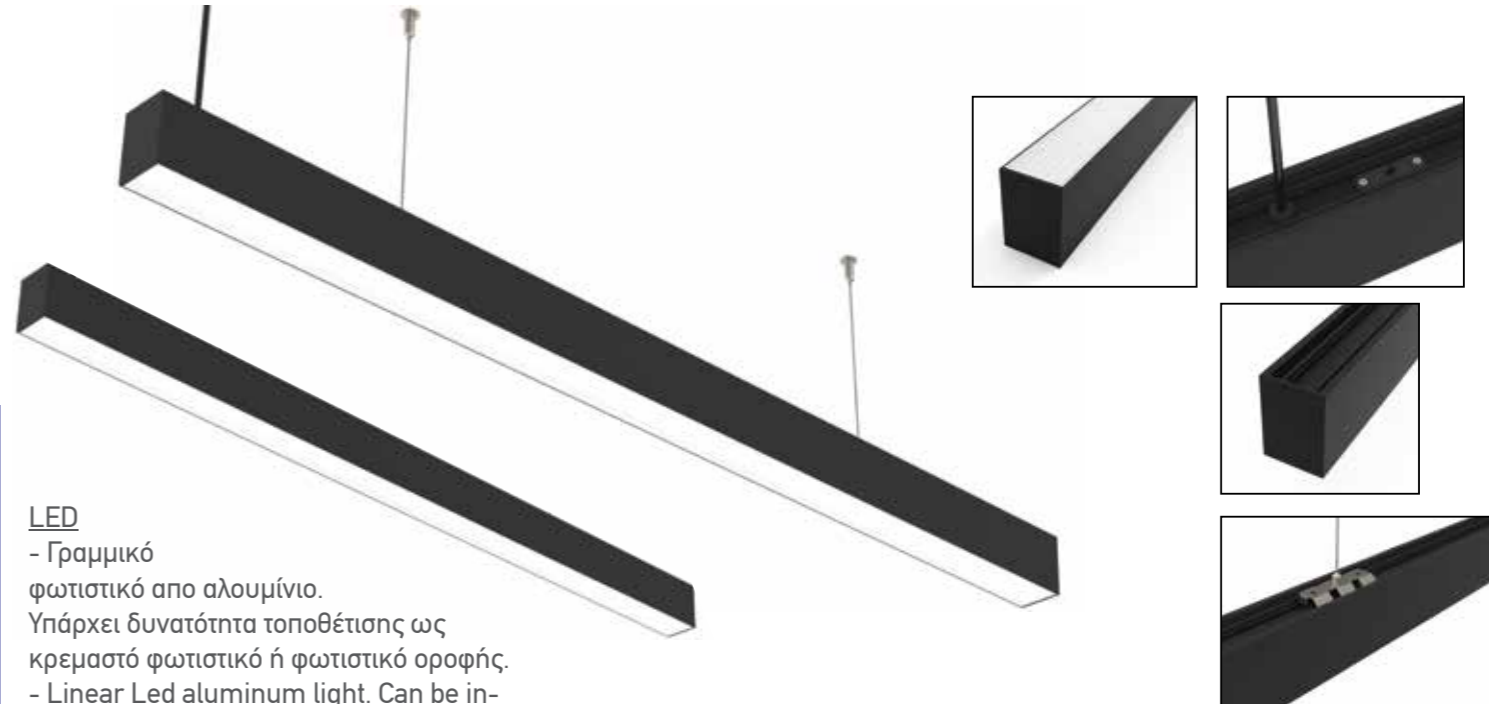

LED

- Γραμμικό φωτιστικό από αλουμίνιο. Υπάρχει δυνατότητα τοποθέτησης ως κρεμαστό φωτιστικό ή φωτιστικό οροφής.
- Linear Led aluminum light. Can be installed as a pendant lamp or ceiling light.

IP20 | 4000K | NON DIMMABLE

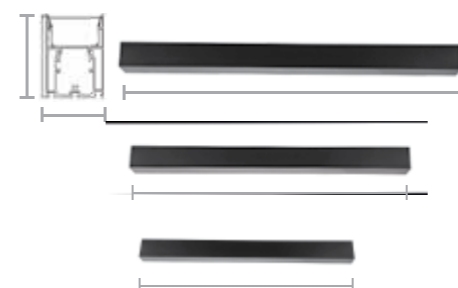

No	6172-180-BL	6172-120-BL	6172-90-BL
Power	50W LED	40W LED	30W LED
Lumens	4000 Lm	3200 Lm	2400 Lm
Color temperature	4000 K	4000 K	4000 K
Material	Aluminum	Aluminum	Aluminum
Dimension	180cm	120cm	90cm
Color	Black	Black	Black
	22-160-00	22-125-00	22-100-00

- Εξαρτήματα για γραμμικά φωτιστικά. Συμβατά με κωδικούς 6172 και 6142
 - Accessories for Linear Lights. Suitable for No 6172 and 6142.

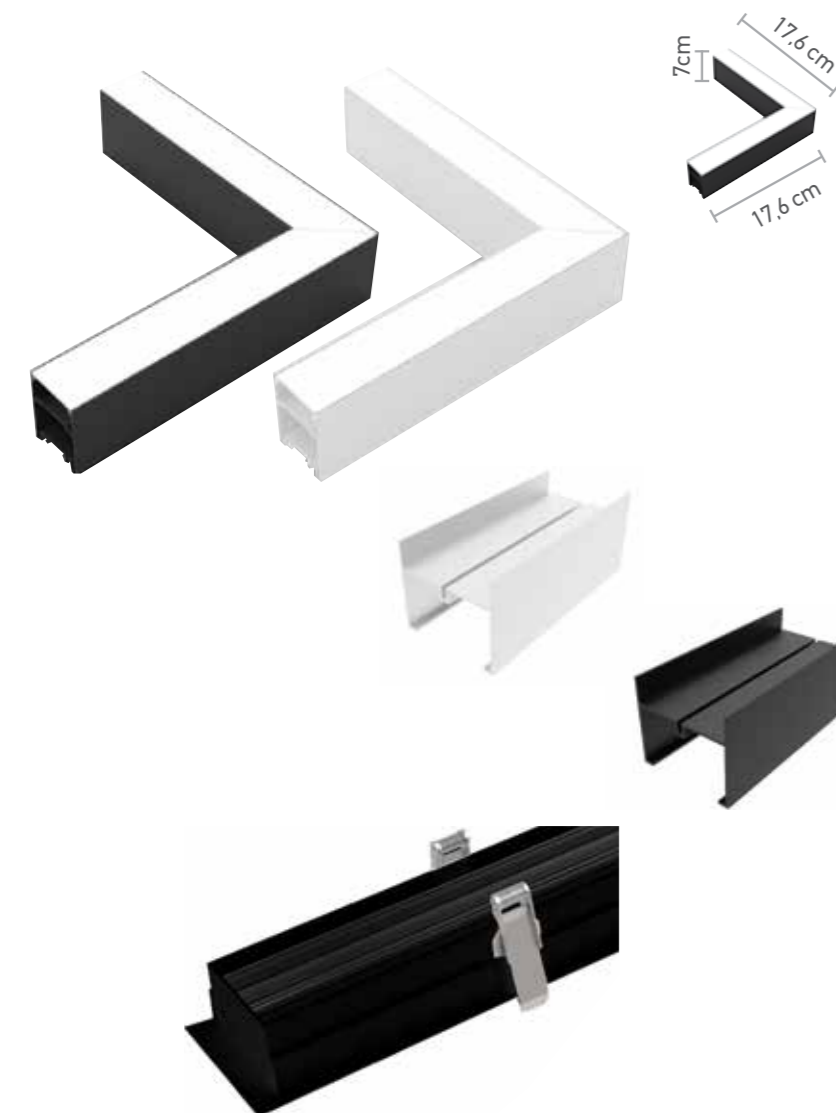

No	L004-BL	L002-BL	L002-WH
Power	8W	8W	8W
Color temperature	3000 K	4000 K	4000 K
Description	L Shape Connector	L Shape Connector	L Shape Connector
Material	Aluminum	Aluminum	Aluminum
Color	Black	Black	White
	22-65-00	22-65-00	22-65-00

No L001-WH	
Description	Connector Straight for Linear Light
Color	White
	22-06-50

No L001-BL	
Description	Connector Straight for Linear Light
Color	Black
	22-06-50



No	L003-180-BL	L003-120-BL	L003-90-BL
Description	Linear recessed frame for linear	Linear recessed frame for linear	Linear recessed frame for linear
Dimension	180cm	120cm	90cm
Color	Black	Black	Black
	22-59-00	22-43-00	22-36-00

No	L003-180-WH	L003-120-WH	L003-90-WH
Description	Linear recessed frame for linear	Linear recessed frame for linear	Linear recessed frame for linear
Dimension	180cm	120cm	90cm
Color	White	White	White
	22-59-00	22-43-00	22-36-00

LED

- Γραμμικό φωτιστικό απο αλουμίνιο. Υπάρχει δυνατότητα τοποθέτησης ως κρεμαστό φωτιστικό ή φωτιστικό οροφής.
 - Linear Led aluminum light. Can be installed as a pendant lamp or ceiling light.

IP20 | 4000K | NON DIMMABLE

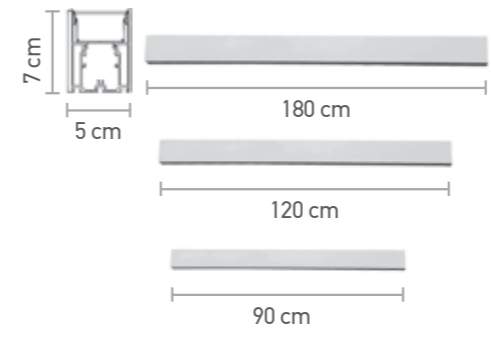
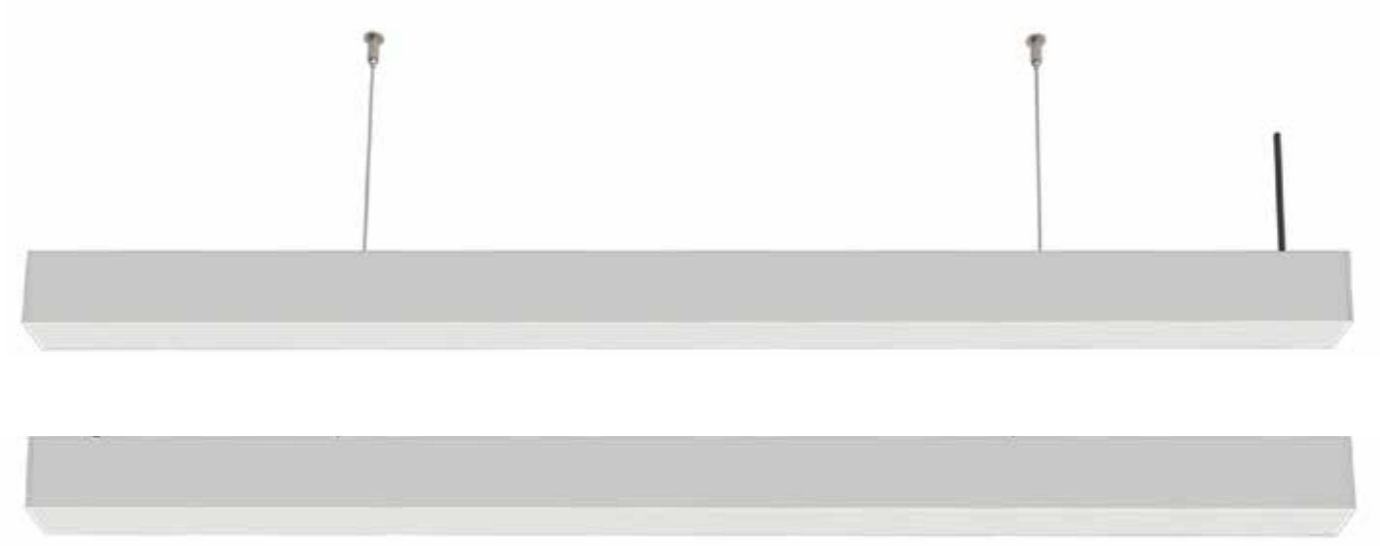

No	6172-180-WH	6172-120-WH	6172-90-WH
Power	50W LED	40W LED	30W LED
Lumens	4000 Lm	3200 Lm	2400 Lm
Color temperature	4000 K	4000 K	4000 K
Material	Aluminum	Aluminum	Aluminum
Dimension	180cm	120cm	90cm
Color	White	White	White
	22-160-00	22-125-00	22-100-00



LED

- Κυκλικό φωτιστικό. Υπάρχει δυνατότητα τοποθέτησης ως κρεμαστό φωτιστικό ή φωτιστικό οροφής.
- Round Led light. Can be installed as a pendant lamp or ceiling light.

IP20 | 4000K | NON DIMMABLE

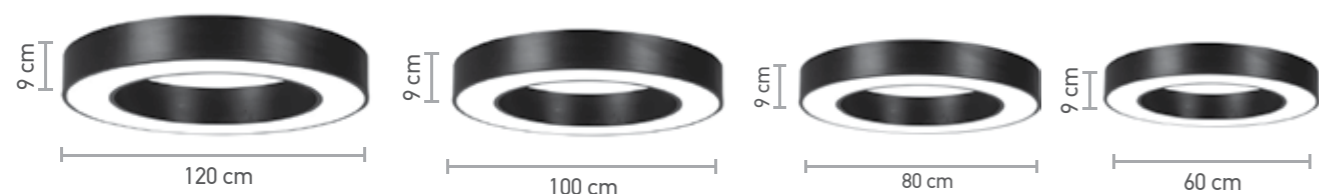
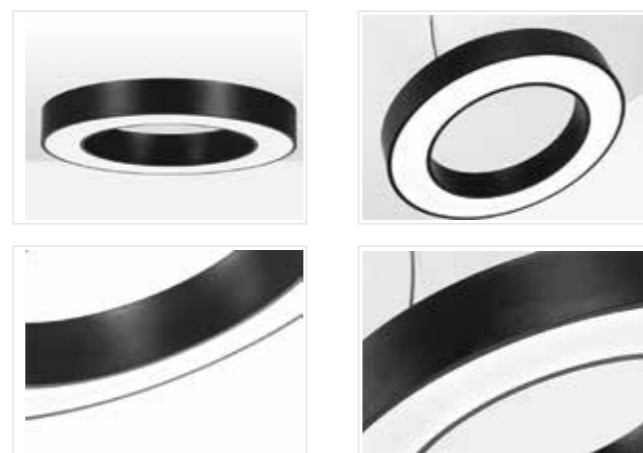

No	6171-120-BL	6171-100-BL	6171-80-BL	6171-60-BL
Power	70W LED	60W LED	50W LED	40W LED
Lumens	5600 Lm	4800 Lm	4000 Lm	3200 Lm
Color temperature	4000 K	4000 K	4000 K	4000 K
Material	Metal & Acrylic	Metal & Acrylic	Metal & Acrylic	Metal & Acrylic
Dimension	120cm	100cm	80cm	60cm
Color	Black	Black	Black	Black
	22-250-00	22-198-00	22-170-00	22-100-00

LED

- Κυκλικό φωτιστικό. Υπάρχει δυνατότητα τοποθέτησης ως κρεμαστό φωτιστικό ή φωτιστικό οροφής.
- Round Led light. Can be installed as a pendant lamp or ceiling light.

IP20 | 4000K | NON DIMMABLE

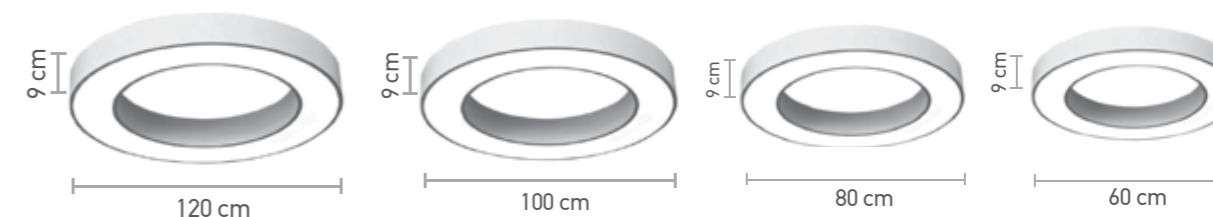

No	6171-120-WH	6171-100-WH	6171-80-WH	6171-60-WH
Power	70W LED	60W LED	50W LED	40W LED
Lumens	5600 Lm	4800 Lm	4000 Lm	3200 Lm
Color temperature	4000 K	4000 K	4000 K	4000 K
Material	Metal & Acrylic	Metal & Acrylic	Metal & Acrylic	Metal & Acrylic
Dimension	120cm	100cm	80cm	60cm
Color	White	White	White	White
	22-250-00	22-198-00	22-170-00	22-100-00



LED

- Κυκλικό φωτιστικό. Υπάρχει δυνατότητα τοποθέτησης ως κρεμαστό φωτιστικό ή φωτιστικό οροφής.

-Round Led light. Can be installed as a pendant lamp or ceiling light.

IP20

3000K

NON
DIMMABLE

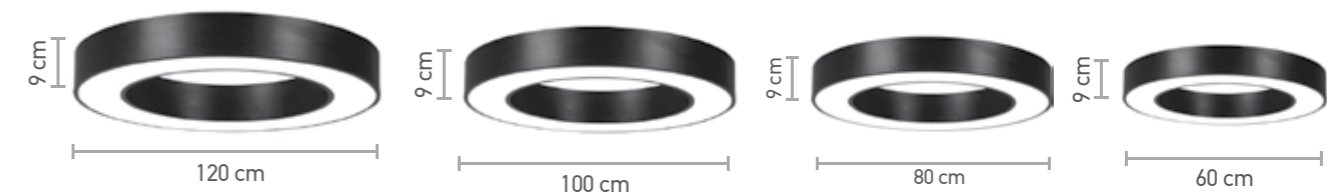

No	6041-120-BL	6041-100-BL	6041-80-BL	6041-60-BL
Power	70W LED	60W LED	50W LED	40W LED
Lumens	5600 Lm	4800 Lm	4000 Lm	3200 Lm
Color temperature	3000 K	3000 K	3000 K	3000 K
Material	Metal & Acrylic	Metal & Acrylic	Metal & Acrylic	Metal & Acrylic
Dimension	120cm	100cm	80cm	60cm
Color	Black	Black	Black	Black
	22-250-00	22-198-00	22-170-00	22-100-00

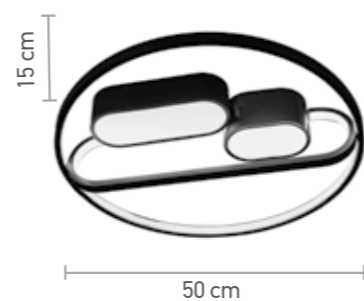



No 6044	
Power	55W LED
Lumens	4600 Lm
Color temperature	3cct with controller
Material	Metal & Acrylic
Dimension	50cm
Color	Black & Golden 
22-235-00	

LED

- Φωτιστικό οροφής από μέταλλο και ακρυλικό.
- Ceiling light in metal and acrylic.

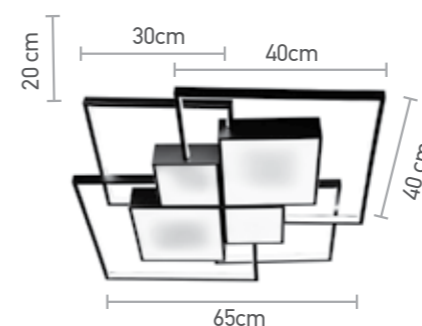
IP20 | 3CCT | DIMMABLE WITH CONTROLLER



No 6047	
Power	108W LED
Lumens	8000 Lm
Color temperature	3cct with controller
Material	Metal & Acrylic
Dimension	65cm x 65cm
Color	Black & Golden 
22-290-00	



LED

- Φωτιστικό οροφής από μέταλλο και ακρυλικό.
- Ceiling light metal and acrylic

IP20 | 3CCT | DIMMABLE WITH CONTROLLER

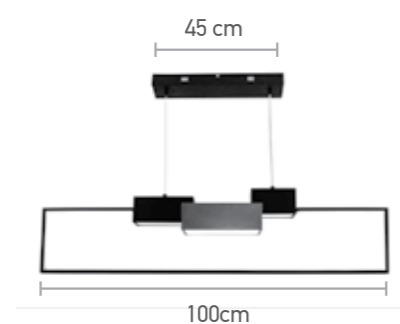

No 6045	
Power	55W LED
Lumens	4600 Lm
Color temperature	3cct with controller
Material	Metal & Acrylic
Dimension	100cm
Color	Black & Golden 
22-207-00	

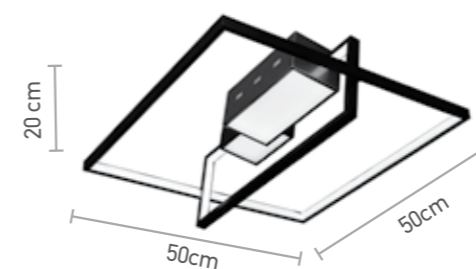

No 6046	
Power	65W LED
Lumens	5600 Lm
Color temperature	3cct with controller
Material	Metal & Acrylic
Dimension	50cm x 50cm
Color	Black & Golden 
22-260-00	





LED

- Φωτιστικό από μέταλλο και ακρυλικό.
- Pendant light in metal and acrylic.

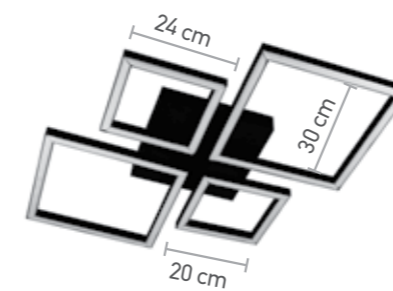
IP20 | 3CCT | DIMMABLE WITH CONTROLLER



No	6050-BL	6051-CH	6051-GL
Power	70W	70W	70W
Lumens	5600 Lm	5600 Lm	5600 Lm
Color temperature	3cct with controller	3cct with controller	3cct with controller
Material	Aluminum & Acrylic	Aluminum & Acrylic	Aluminum & Acrylic
Dimension	65cm x 65cm	65cm x 65cm	65cm x 65cm
Color	Black 	Chrome 	Golden 
	22-290-00	22-320-00	22-320-00





LED
 - Φωτιστικό από μέταλλο και ακρυλικό.
 -Pendant light in metal and acrylic.

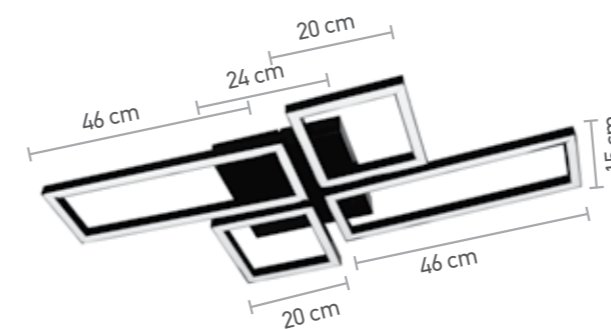

IP20 | 3CCT | DIMMABLE WITH CONTROLLER



No	6048-BL	6049-CH	6049-GL
Power	60W	60W	60W
Lumens	4800 Lm	4800 Lm	4800 Lm
Color temperature	3cct with controller	3cct with controller	3cct with controller
Material	Aluminum & Acrylic	Aluminum & Acrylic	Aluminum & Acrylic
Dimension	95cm x 40cm	95cm x 40cm	95cm x 40cm
Color	Black 	Chrome 	Golden 
	22-250-00	22-280-00	22-280-00





LED

- Φωτιστικό από μέταλλο και ακρυλικό.
- Pendant light in metal and acrylic.

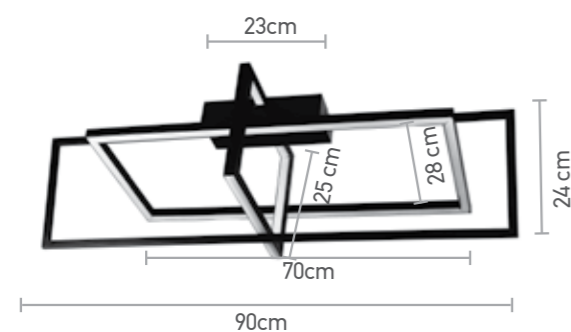
IP20 | 3000K | DIMMABLE



No	6055-BL	6056-GL
Power	35W	35W
Lumens	2800 Lm	2800 Lm
Color temperature	3000 K	3000 K
Material	Aluminum & Acrylic	Aluminum & Acrylic
Dimension	90cm x 30cm	90cm x 30cm
Color	Black 	Golden 
	22-187-00	22-220-00

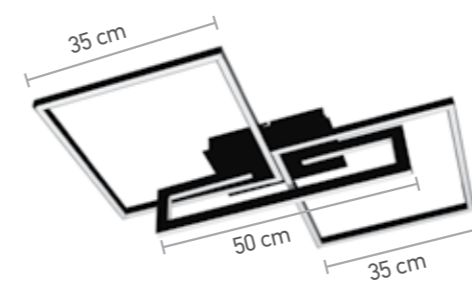

No	6053-BL	6054-GL
Power	45W	45W
Lumens	3600 Lm	3600 Lm
Color temperature	3000 K	3000 K
Material	Aluminum & Acrylic	Aluminum & Acrylic
Dimension	70cm x 70cm	70cm x 70cm
Color	Black 	Golden 
	22-225-00	22-240-00

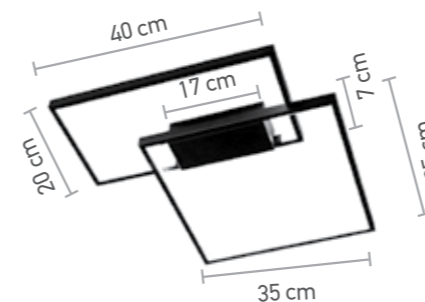



No 6065-BL	
Power	38W LED
Lumens	3050 Lm
Color temperature	3000 K
Material	Aluminum & Acrylic
Dimension	45cm x 45cm
Color	Black 
22-115-50	

LED

- Φωτιστικά οροφής LED απο αλουμίνιο και ακρυλικό κάλυμμα.
- LED Lighting fixtures in aluminum and acrylic.

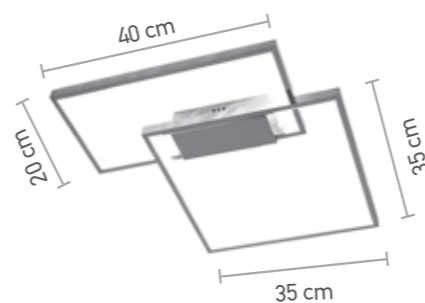
IP20 | 3000K | DIMMABLE



No 6066-CH	
Power	38W
Lumens	3050 Lm
Color temperature	3000 K
Material	Aluminum & Acrylic
Dimension	45cm x 45cm
Color	Chrome 
22-160-00	

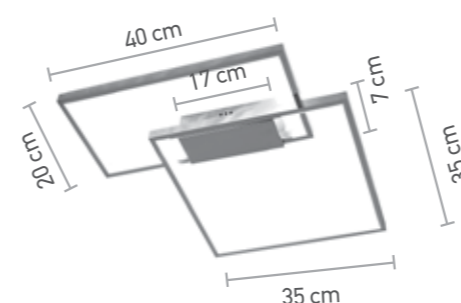

No 6066-GL	
Power	38W LED
Lumens	3050 Lm
Color temperature	3000 K
Material	Aluminum & Acrylic
Dimension	45cm x 45cm
Color	Gold 
22-160-00	



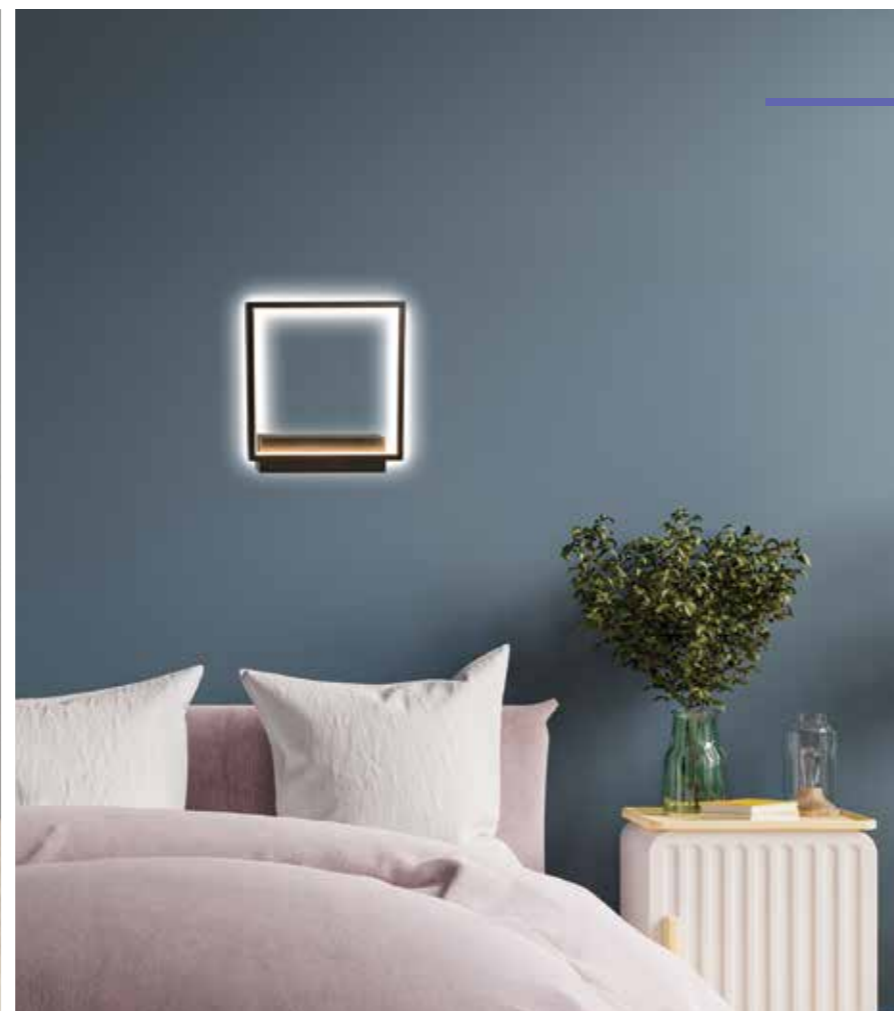

LED

- Φωτιστικά LED απο αλουμίνιο και ακρυλικό κάλυμμα.
- LED Lighting fixtures in aluminum and acrylic.

IP20 | 3000K | NON DIMMABLE

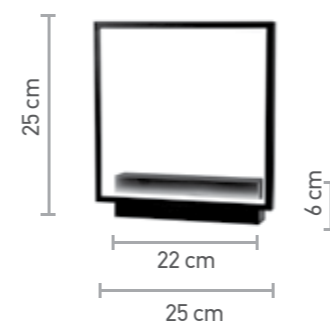

No 43034	
Power	18W LED
Lumens	1500 Lm
Color temperature	3000 K
Material	Aluminum & Acrylic
Dimension	25cm x 25cm
Color	Black 
22-55-00	

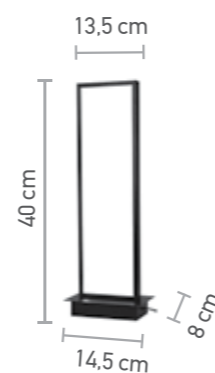

No 3020	
Power	16W LED
Lumens	1300 Lm
Color temperature	3000 K
Material	Aluminum & Acrylic
Dimension	14,5cm x 40cm
Color	Black 
22-64-00	

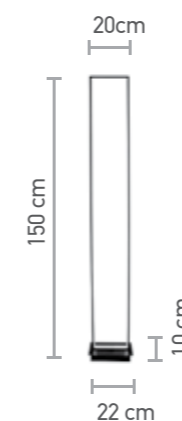

No 45022	
Power	45W LED
Lumens	3600 Lm
Color temperature	3000 K
Material	Aluminum & Acrylic
Dimension	22cm x 150cm
Color	Black 
22-156-00	





LED

- Κρεμαστό φωτιστικό από μέταλλο και ακρυλικό.
- Pendant light in metal and acrylic.

IP20 | 3000K | NON DIMMABLE

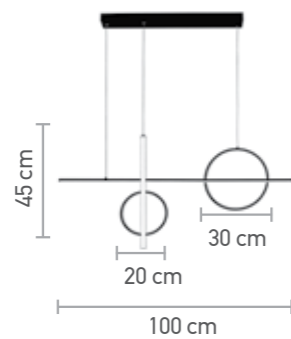
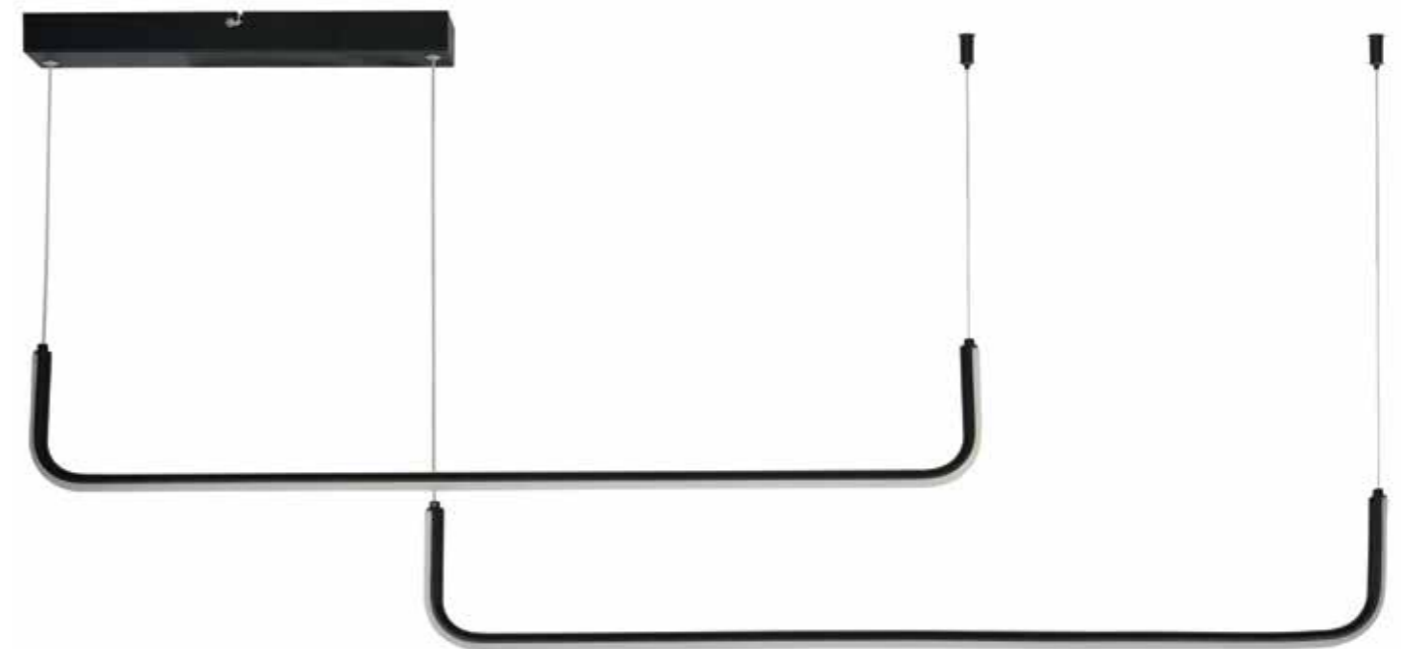

No 6043	
Power	55W LED
Lumens	4400 Lm
Color temperature	3000 K
Material	Metal & Acrylic
Dimension	100cm x 45cm
Color	Black
22-115-00	

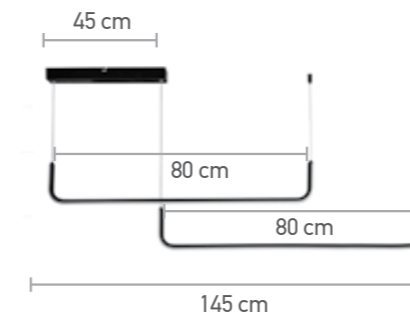

No 6052-BL	
Power	38W LED
Lumens	3050 Lm
Color temperature	3000 K
Material	Metal & Acrylic
Dimension	145cm x 100cm
Color	Black
22-80-00	



LED

- Φωτιστικό από αλουμίνιο και ακρυλικό.
- Pendant light in aluminium and acrylic.

IP20 | 3000K | NON DIMMABLE



No 6057-BL	
Power	16W LED
Lumens	1280 Lm
Color temperature	3000 K
Material	Aluminum & Acrylic
Dimension	20cm x 20cm
Color	Black
22-50-00	



LED

- Κρεμαστά φωτιστικά από αλουμίνιο και ακρυλικό.
- Pendant lights in aluminum and acrylic.

IP20 | 3000K | NON DIMMABLE



No	6058-BL
Power	14W
Lumens	1100 Lm
Color temperature	3000K
Material	Aluminum & Acrylic
Dimension	17cm x 52cm
Color	Black
22-55-00	





LED

- Κρεμαστά φωτιστικά από αλουμίνιο και ακρυλικό.
- Pendant lights in aluminum and acrylic.

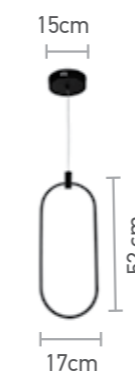
IP20 | 3000K | NON DIMMABLE



No	6059-CH	6059-GL
Power	14W	14W
Lumens	1100 Lm	1100 Lm
Color temperature	3000K	3000K
Material	Aluminum & Acrylic	Aluminum & Acrylic
Dimension	17cm x 52cm	17cm x 52cm
Color	Chrome 	Golden 
	22-72-00	22-72-00



LED

- Κρεμαστά φωτιστικά απο μέταλλο.
- Pendant lights in metal.

IP20 | **3000K** | **NON DIMMABLE**



No	4018-BL	4018-WH	4019-GL
Power	5W LED	5W LED	5W LED
Lumens	450 Lm	450 Lm	450 Lm
Color temperature	3000 K	3000 K	3000 K
Material	Metal	Metal	Metal
Dimension	3,5cm x 50cm	3,5cm x 50cm	3,5cm x 50cm
Color	Black 	White 	Golden 
	22-39-00	22-39-00	22-48-50

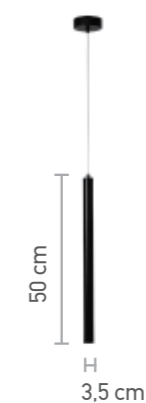



LED

- Φωτιστικά οροφής LED από αλουμίνιο και ακρυλικό κάλυμμα.
- Lighting fixtures in aluminum and acrylic.

IP20 | 3000K | NON DIMMABLE

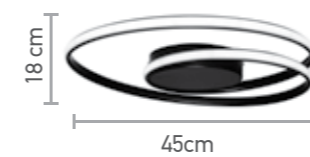

No	42027-BL	42028-CH	42028-GL
Power	36W	36W	36W
Lumens	2900 Lm	2900 Lm	2900 Lm
Color temperature	3000 K	3000 K	3000 K
Material	Aluminum & Acrylic	Aluminum & Acrylic	Aluminum & Acrylic
Dimension	45cm x 18cm	45cm x 18cm	45cm x 18cm
Color	Black 	Chrome 	Golden 
	22-95-00	22-120-00	22-120-00



LED

- Φωτιστικά απο μέταλλο και ακρυλικό.
- Lighting fixtures in metal and acrylic.

IP20 | 3000K | NON DIMMABLE



No 45019-BL

Power	36W LED
Lumens	2900 Lm
Color temperature	3000 K
Material	Metal & Acrylic
Dimension	24cm x 165cm
Color	Black

22-199-00

No 3019-BL

Power	22W LED
Lumens	1760 Lm
Color temperature	3000 K
Material	Metal & Acrylic
Dimension	19,5cm x 43cm
Color	Black

22-56-50

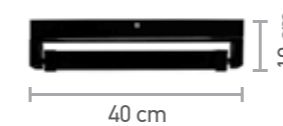

No 43029-B

Power	12W LED
Lumens	960 Lm
Color temperature	3000 K
Material	Metal & Acrylic
Dimension	40cm x 10cm
Color	Black

22-45-00

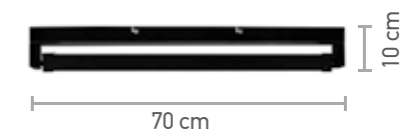

No 43029-A

Power	22W LED
Lumens	1800 Lm
Color temperature	3000 K
Material	Metal & Acrylic
Dimension	70cm x 10cm
Color	Black

22-65-00



LED

- Φωτιστικά led από ακρυλικό.
- Led lighting fixtures in acrylic.

IP20 | 3CCT | DIMMABLE WITH CONTROLLER

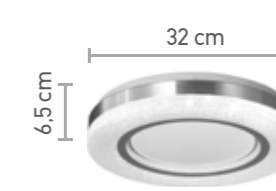
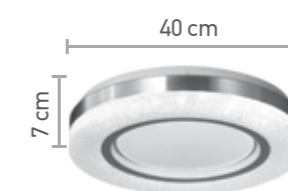
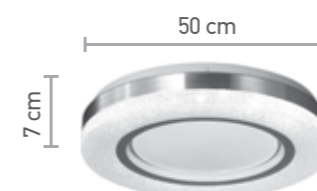

No 42016-A	
Power	72W
Lumens	5400 Lm
Color temperature	3cct with controller (3000K/4000K/6000K)
Material	Metal & Acrylic
Dimension	50cm x 7cm
Color	Silver
22-84-00	

No 42016-B	
Power	54W
Lumens	4050 Lm
Color temperature	3cct with controller (3000K/4000K/6000K)
Material	Metal & Acrylic
Dimension	40cm x 7cm
Color	Silver
22-62-00	

No 42016-C	
Power	36W
Lumens	2700 Lm
Color temperature	3cct with controller (3000K/4000K/6000K)
Material	Metal & Acrylic
Dimension	32cm x 6,5cm
Color	Silver
22-47-00	



LED

- Φωτιστικό Led από ακρυλικό.
- Ceiling light in acrylic.

IP20 | 3000K | NON DIMMABLE



LED

- Φωτιστικό Led από ακρυλικό.
- Ceiling light in acrylic.

IP20 | 3000K | NON DIMMABLE

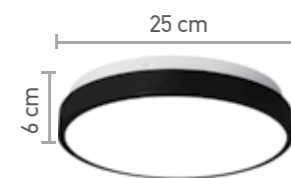

No 42014	
Power	12W
Lumens	900 Lm
Color temperature	4000 K
Material	Metal & Acrylic
Dimension	25cm x 6cm
Color	Black
22-24-90	

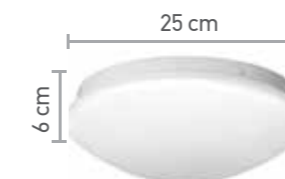

No 42015	
Power	12W
Lumens	900 Lm
Color temperature	3000 K
Material	Metal & Acrylic
Dimension	25cm x 6cm
Color	Opal Cover
22-21-00	



LED

- Φωτιστικά Led από μέταλλο και ακρυλικό.
- Lighting fixtures in metal and acrylic .

IP20 | 3CCT | DIMMABLE WITH CONTROLLER



No 42023-A White	
Power	110W
Lumens	8200 Lm
Color temperature	3 cct with controller
Material	Metal & Acrylic
Dimension	60cm x 8cm
Color	White
22-168-00	



No 42023-B White	
Power	54W
Lumens	4050 Lm
Color temperature	3 cct with controller
Material	Metal & Acrylic
Dimension	40cm x 8cm
Color	White
22-123-00	



No 42024-A Golden	
Power	110W
Lumens	8200 Lm
Color temperature	3 cct with controller
Material	Metal & Acrylic
Dimension	60cm x 8cm
Color	Golden
22-182-00	



No 42024-B Golden	
Power	54W
Lumens	4050 Lm
Color temperature	3 cct with controller
Material	Metal & Acrylic
Dimension	40cm x 8cm
Color	Golden
22-130-00	



No 42023-A Black	
Power	110W
Lumens	8200 Lm
Color temperature	3 cct with controller
Material	Metal & Acrylic
Dimension	60cm x 8cm
Color	Black
22-168-00	



No 42023-B Black	
Power	54W
Lumens	4050 Lm
Color temperature	3 cct with controller
Material	Metal & Acrylic
Dimension	40cm x 8cm
Color	Black
22-123-00	



LED

- Φωτιστικά Led από μέταλλο και ακρυλικό.
- Lighting fixtures in metal and acrylic.

IP20 | 3CCT

DIMMABLE WITH CONTROLLER



No 42021-A Golden	
Power	110W
Lumens	8200 Lm
Color temperature	3 cct with controller
Material	Metal & Acrylic
Dimension	60cm x 8cm
Color	Golden
22-165-00	

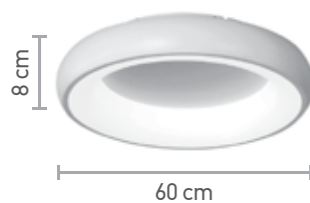

No 42021-B Golden	
Power	54W
Lumens	4050 Lm
Color temperature	3 cct with controller
Material	Metal & Acrylic
Dimension	40cm x 8cm
Color	Golden
22-116-00	

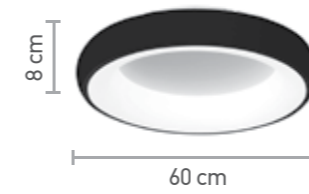
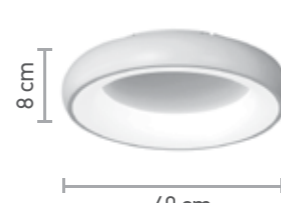

No 42020-A Black	
Power	110W
Lumens	8200 Lm
Color temperature	3 cct with controller
Material	Metal & Acrylic
Dimension	60cm x 8cm
Color	Black
220-150-00	

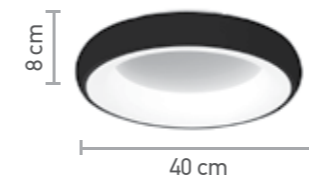

No 42020-B Black	
Power	54W
Lumens	4050 Lm
Color temperature	3 cct with controller
Material	Metal & Acrylic
Dimension	40cm x 8cm
Color	Black
22-105-00	



No 42020-A White	
Power	110W
Lumens	8200Lm
Color temperature	3 cct with controller
Material	Metal & Acrylic
Dimension	60cm x 8cm
Color	White
22-150-00	

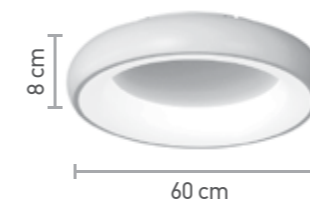

No 42020-B White	
Power	54W
Lumens	4050 Lm
Color temperature	3 cct with controller
Material	Metal & Acrylic
Dimension	40cm x 8cm
Color	White
22-105-00	

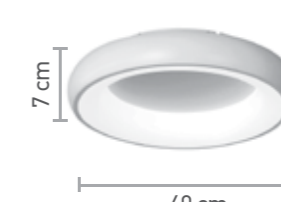





LED

- Φωτιστικά Led από μαύρο μέταλλο και ακρυλικό.
- Lighting fixtures in black metal and acrylic .

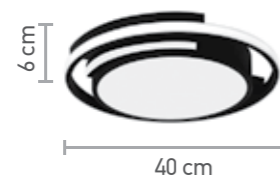
IP20 | 3000K | NON DIMMABLE



No 42018	
Power	56W
Lumens	4200 Lm
Color temperature	3000 K
Material	Metal & Acrylic
Dimension	40cm x 6cm
Color	Black 
22-88-50	

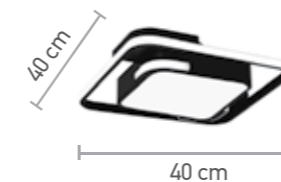

No 42019	
Power	60W
Lumens	4500 Lm
Color temperature	3000 K
Material	Metal & Acrylic
Dimension	40cm x 6cm
Color	Black 
22-92-00	





LED

- Φωτιστικό από μέταλλο, ακρυλικό και λευκή οπαλίνα.

-Pendant light in metal, acrylic and opal glass.

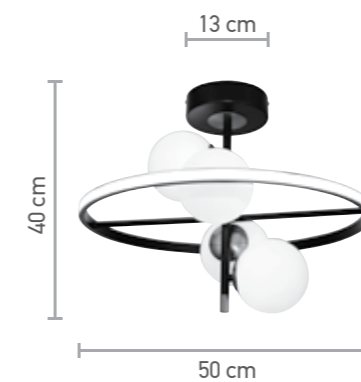
G9 | IP20 | 3000K | NON DIMMABLE



No 6063	
Bulb	4xG9
Power	20W LED
Lumens	1600 Lm
Color temperature	3000K
Material	Metal, Acrylic & Opal glass
Dimension	50cm x 40cm
Color	Black & Golden 
22-175-00	



LED

- Φωτιστικά από μέταλλο, ακρυλικό και λευκή οπαλίνα.
 -Pendant lights in metal, acrylic and opal glass.

G9 | IP20 | 3000K | NON DIMMABLE

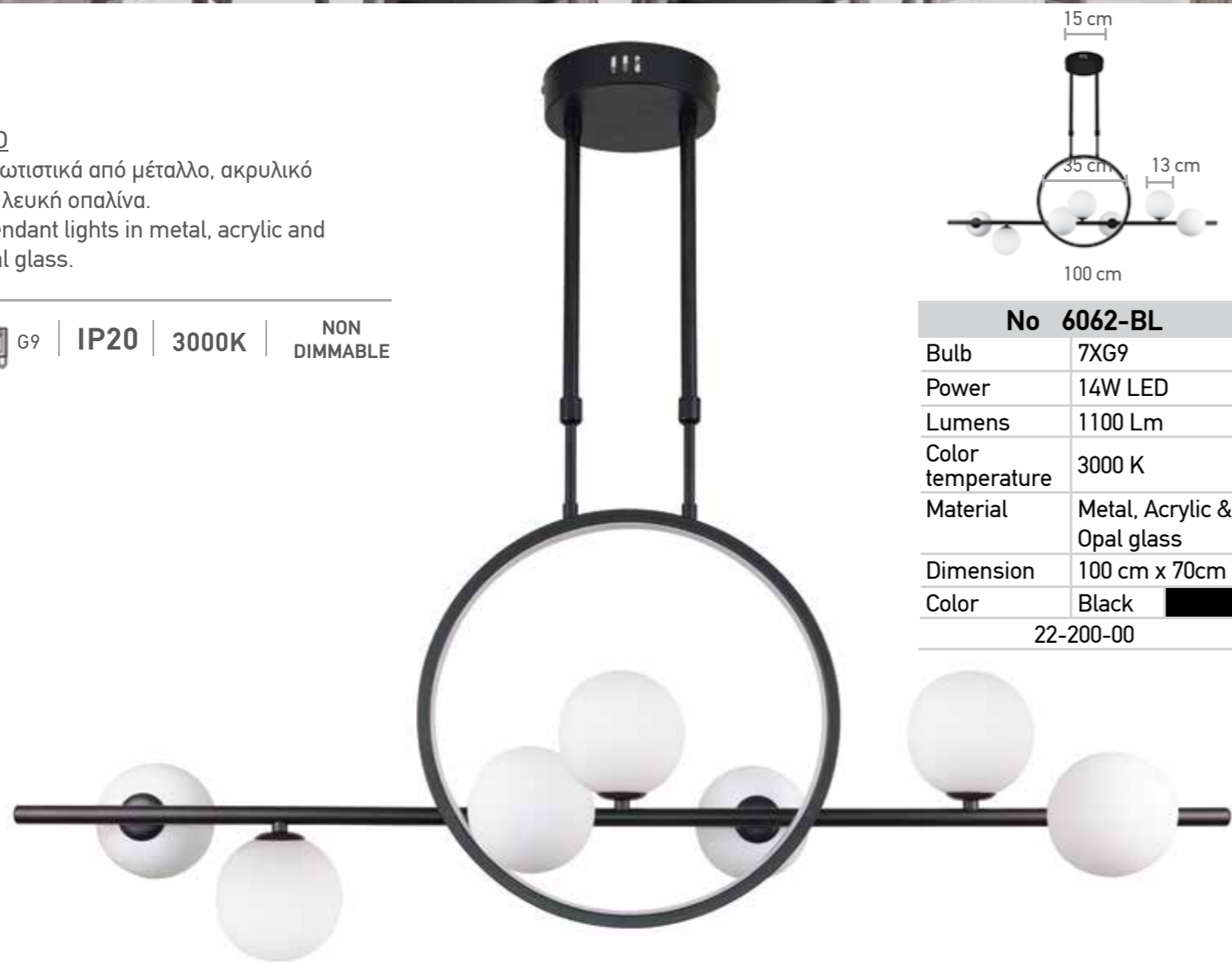

No 6062-BL	
Bulb	7xG9
Power	14W LED
Lumens	1100 Lm
Color temperature	3000 K
Material	Metal, Acrylic & Opal glass
Dimension	100 cm x 70cm
Color	Black
22-200-00	



No 6061-BL	
Bulb	1xG9
Power	14W LED
Lumens	1100 Lm
Color temperature	3000 K
Material	Metal, Acrylic & Opal glass
Dimension	30cm
Color	Black
22-90-50	

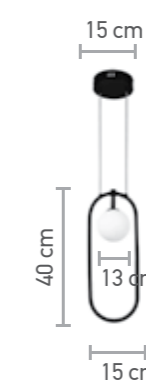



No 6060-BL	
Bulb	1xG9
Power	14W LED
Lumens	1100 Lm
Color temperature	3000 K
Material	Metal, Acrylic & Opal glass
Dimension	15cm x 40cm
Color	Black
22-55-00	

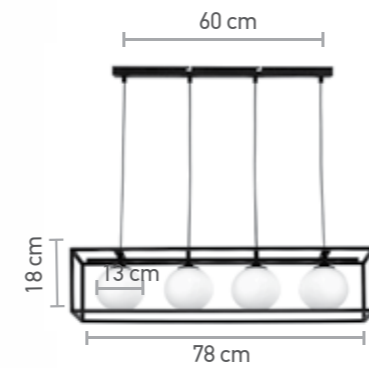
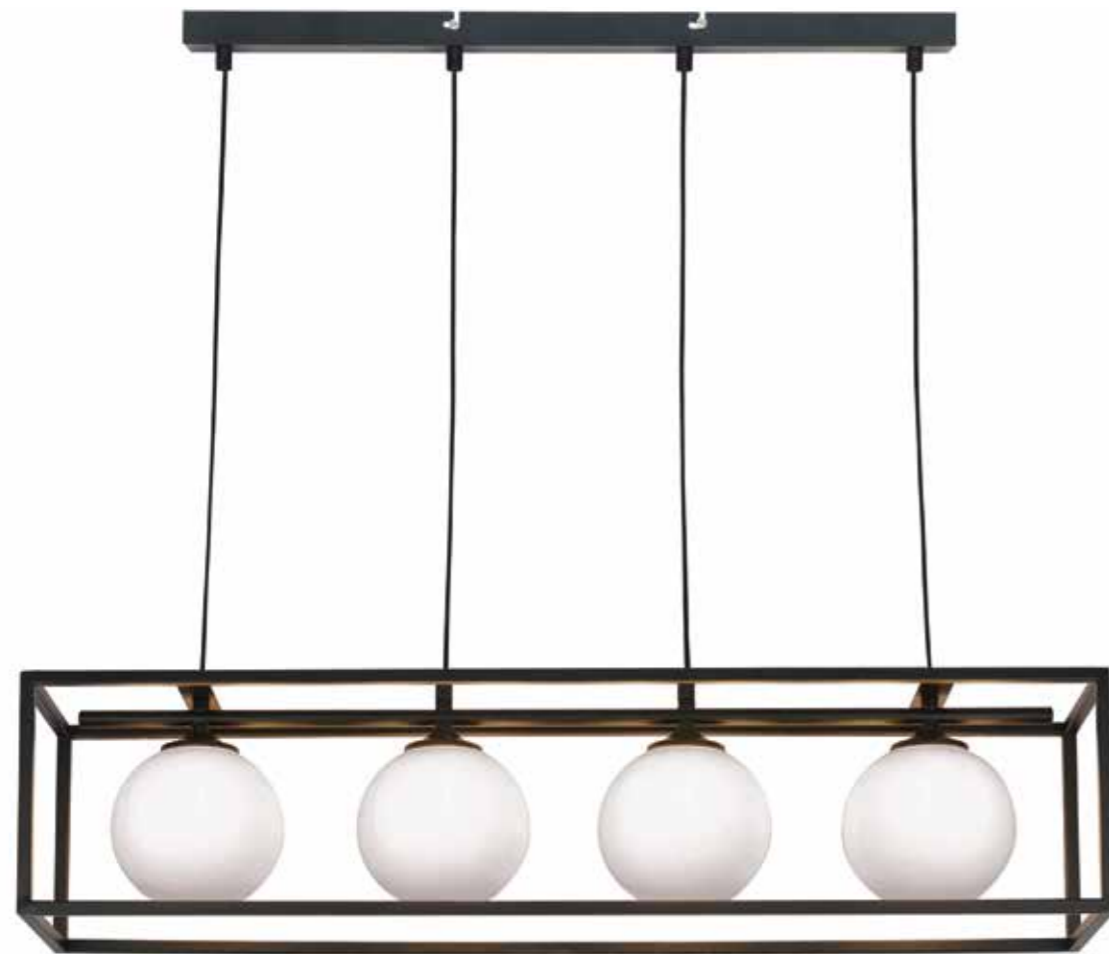

- Φωτιστικά απο μαύρο μέταλλο και οπαλίνα.
- Lighting fixtures in black metal and opal glass.

 G9 | IP20



No 6064 - BL	
Bulb	4xG9
Material	Metal & Opal glass
Dimension	78cm x 18cm
Color	Black 
22-130-00	

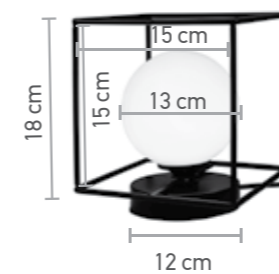

No 3018 - BL	
Bulb	1xG9
Material	Metal & Opal glass
Dimension	18cm x 18cm
Color	Black 
22-43-00	





No 4020 - BL	
Bulb	1xG9
Material	Metal & Opal glass
Dimension	18cm x 18cm
Color	Black 
22-37-00	



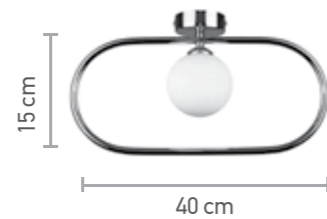

- Φωτιστικά από μαύρο μέταλλο και γυαλί οπαλίνα.
- Lighting fixtures in black metal and opal glass.

 G9 | IP20

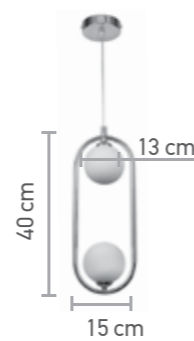

No 43030- BL	
Bulb	1xG9
Material	Metal & Opal glass
Dimension	40cm x 15cm
Color	Black 
22-34-00	



No 4023-BL	
Bulb	2xG9
Material	Metal & Opal glass
Dimension	15cm x 40cm
Color	Black 
22-44-00	

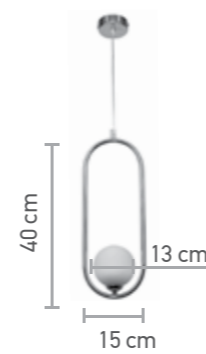

No 4021-BL	
Bulb	1xG9
Material	Metal & Opal glass
Dimension	15cm x 40cm
Color	Black 
22-35-00	

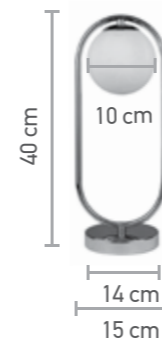

No 3016- BL	
Bulb	1xG9
Material	Metal & Opal glass
Dimension	15cm x 40cm
Color	Black 
22-46-00	

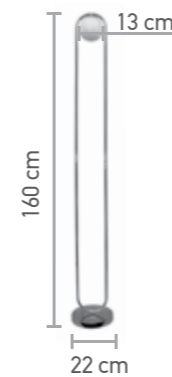

45015-BL	
Bulb	1xG9
Material	Metal & Opal glass
Dimension	22cm x 160cm
Color	Black 
22-90-00	





- Φωτιστικά από χρώμιο μέταλλο και γυαλί οπαλίνα.
- Lighting fixtures in chrome metal and opal glass.

G9 | IP20



No 43031-CH	
Bulb	1xG9
Material	Metal & Opal glass
Dimension	40cm x 15cm
Color	Chrome
22-40-00	

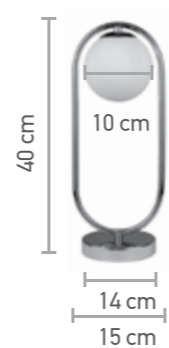

No 3017-CH	
Bulb	1xG9
Material	Metal & Opal glass
Dimension	15cm x 40cm
Color	Chrome
22-56-60	



45016-CH	
Bulb	1xG9
Material	Metal & Opal glass
Dimension	22cm x 160cm
Color	Chrome
22-115-00	

No 4022-CH	
Bulb	1xG9
Material	Metal & Opal glass
Dimension	15cm x 40cm
Color	Chrome
22-46-00	

No 4023-CH	
Bulb	2xG9
Material	Metal & Opal glass
Dimension	15cm x 40cm
Color	Chrome
22-54-00	

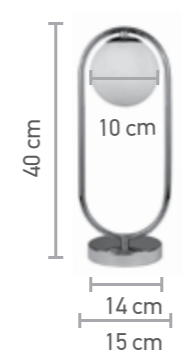

No 3017-GL	
Bulb	1xG9
Material	Metal & Opal glass
Dimension	15cm x 40cm
Color	Golden 
22-56-60	

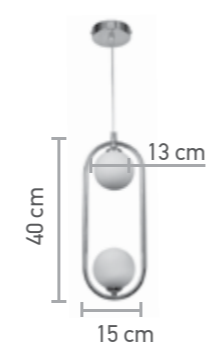

No 4023-GL	
Bulb	2xG9
Material	Metal & Opal glass
Dimension	15cm x 40cm
Color	Golden 
22-54-00	

- Φωτιστικά από χρυσαφί μέταλλο και γυαλί οπαλίνα.
- Lighting fixtures in golden and opal glass.

 G9 | IP20

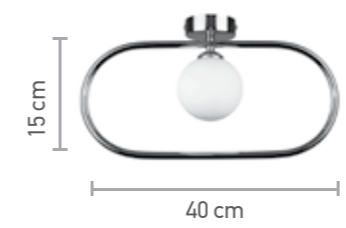

No 43031- GL	
Bulb	1xG9
Material	Metal & Opal glass
Dimension	40cm x 15cm
Color	Golden 
22-40-00	

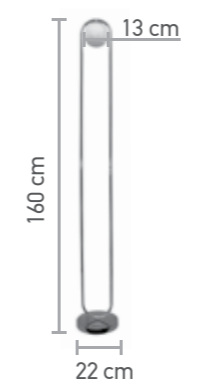

No 45016-GL	
Bulb	1xG9
Material	Metal & Opal glass
Dimension	160cm x 22cm
Color	Golden 
22-115-00	

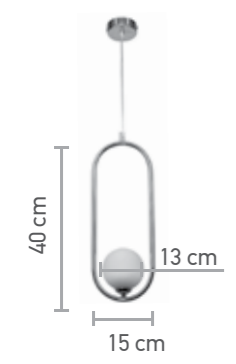

No 4022-GL	
Bulb	1xG9
Material	Metal & Opal glass
Dimension	15cm x 40cm
Color	Golden 
22-46-00	

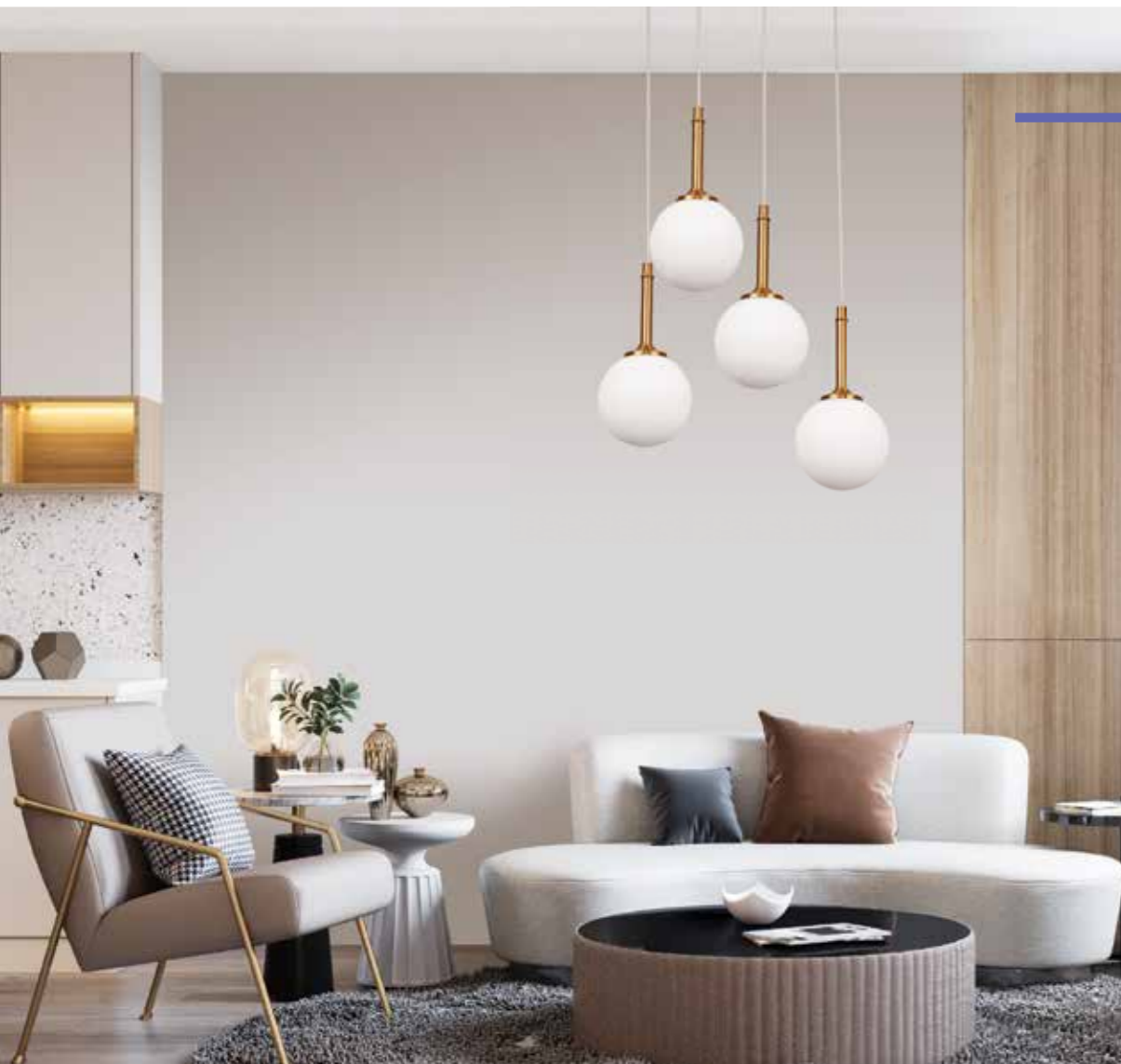

- Φωτιστικά από χρυσό μέταλλο και γυαλί οπαλίνα.
- Lighting fixtures in golden metal and opal glass.

G9 | IP20



No 4016-4/ROSETTE

Bulb	4xG9
Material	Metal & White Opal
Dimension	30cm x 110cm
Color	Golden
22-147-50	



No 4016-3/ROSETTE

Bulb	3xG9
Material	Metal & White Opal
Dimension	30cm x 110cm
Color	Golden
22-115-50	

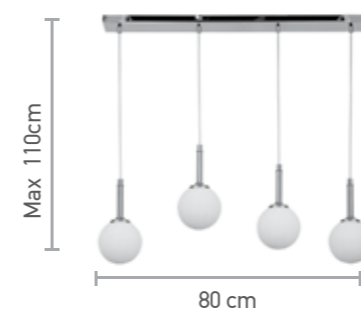

No 4016-4/RAIL

Bulb	4xG9
Material	Metal & White Opal
Dimension	80cm x 110cm
Color	Golden
22-147-50	



No 4016-1

Bulb	1xG9
Material	Metal & White Opal
Dimension	13cm x 110cm
Color	Golden
22-31-90	

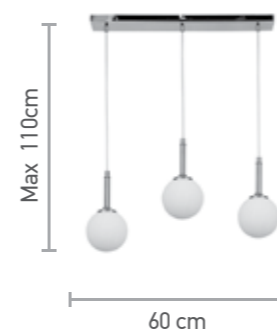

No 4016-3/RAIL

Bulb	3xG9
Material	Metal & White Opal
Dimension	60cm x 110cm
Color	Golden
22-115-50	





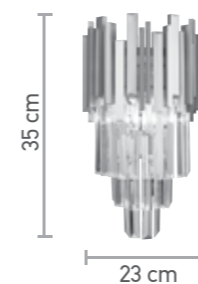

- Φωτιστικά με κρύσταλλα.
- Lighting fixtures with crystals.

E14 | IP20

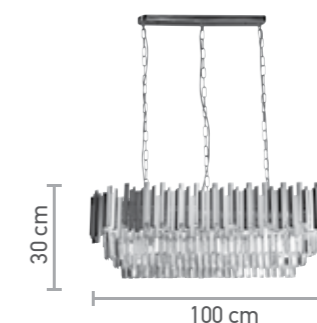

No 43035	
Bulb	1xE14
Material	Aluminum & Crystal
Dimension	23cm x 35cm
Color	Golden 
22-57-00	



No 6069-12	
Bulb	12xE14
Material	Aluminum & Crystal
Dimension	100cm x 30cm
Color	Golden 
22-330-00	



- Κρεμαστά φωτιστικά με κρύσταλλα.
- Pendant lights with crystals.

E14 | IP20



No 6068-4	
Bulb	4xE14
Material	Aluminum & Crystal
Dimension	40cm x 35cm
Color	Golden 
22-140-00	



No 6068-8	
Bulb	8xE14
Material	Aluminum & Crystal
Dimension	60cm x 43cm
Color	Golden 
22-270-00	



- Κρεμαστό φωτιστικό με κρύσταλλα.
- Pendant light with crystals.

E14 | IP20



No 6068-12	
Bulb	12xE14
Material	Aluminum & Crystal
Dimension	80cm x 47cm
Color	Golden 
22-420-00	



- Κρεμαστό φωτιστικό απο σχοινί.
- Pendant light in rope.

 E27 | IP20

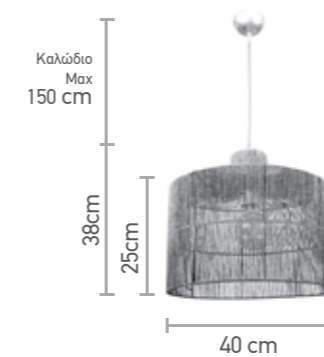

No 4030	
Bulb	1xE27
Material	Rope
Dimension	40cm x 38cm
22-90-00	



- Κρεμαστό φωτιστικό από σχοινί.
- Pendant light in rope.

 E27 | IP20

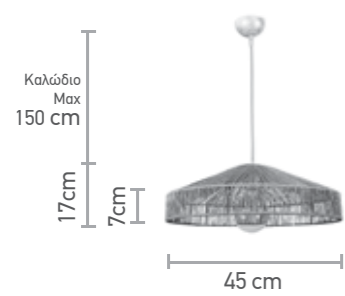

No 4029B	
Bulb	1xE27
Material	Rope
Dimension	45cm x 17cm
22-57-00	

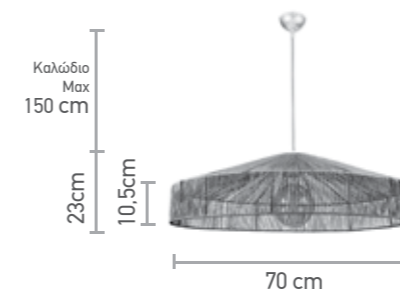

No 4029A	
Bulb	1xE27
Material	Rope
Dimension	70cm x 23cm
22-110-00	



- Φωτιστικά από λευκό ή μαύρο μέταλλο, ξύλο και σχοινί.
- Lights in white or black metal, wood and rope.

 E27 | IP20



No 4025B	
Bulb	1xE27
Material	Metal & Wood & Rope
Dimension	17cm x 30cm
Color	Black
22-57-00	



No 4025A	
Bulb	1xE27
Material	Metal & Wood & Rope
Dimension	26cm x 46cm
Color	Black
22-82-00	



No 4026B	
Bulb	1xE27
Material	Metal & Wood & Rope
Dimension	17cm x 41cm
Color	White
22-57-00	

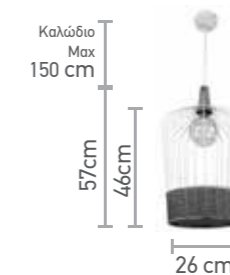

No 4026A	
Bulb	1xE27
Material	Metal & Wood & Rope
Dimension	26cm x 57cm
Color	White
22-82-00	



- Φωτιστικά από μαύρο μέταλλο, ξύλο και σχοινί.
- Lights in black metal, wood and rope.

E27 | IP20

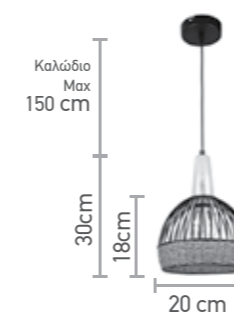

No 4027B	
Bulb	1xE27
Material	Metal & Wood & Rope
Dimension	20cm x 30cm
Color	Black
22-57-00	

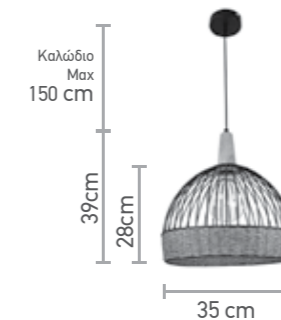

No 4027A	
Bulb	1xE27
Material	Metal & Wood & Rope
Dimension	35cm x 39cm
Color	Black
22-82-00	



- Φωτιστικά από λευκό μέταλλο, ξύλο και σχοινί.
- Lights in white metal, wood and rope.

 E27 | IP20



No 4028B	
Bulb	1xE27
Material	Metal & Wood & Rope
Dimension	20cm x 30cm
Color	White
22-57-00	



No 4028A	
Bulb	1xE27
Material	Metal & Wood & Rope
Dimension	35cm x 39cm
Color	White
22-82-00	

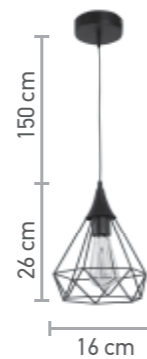

No 4024-BL	
Bulb	1XE27
Material	Metal
Dimension	26 x 16cm
Color	Black
22-18-00	

- Φωτιστικά από μαύρο μέταλλο.
- Lighting fixtures in black metal.

E27 | IP20



No 4024-3-BL/RAIL	
Bulb	3XE27
Material	Metal
Dimension	60cm x 176cm
Color	Black
22-76-00	

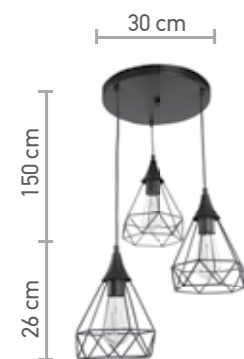

No 4024-3-BL/ROSETTE	
Bulb	3XE27
Material	Metal
Dimension	30cm x 176cm
Color	Black
22-76-00	



No 4024-2-BL/ROSETTE	
Bulb	2XE27
Material	Metal
Dimension	20cm x 176cm
Color	Black
22-46-00	

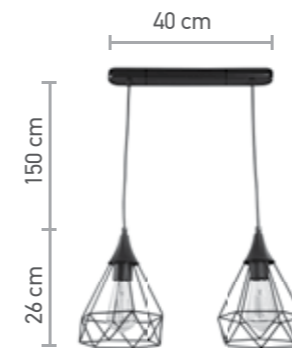

No 4024-2-BL/RAIL	
Bulb	2XE27
Material	Metal
Dimension	40cm x 176cm
Color	Black
22-46-00	





- Φωτιστικά από λευκό μέταλλο.
- Lighting fixtures in white metal.

 E27 | IP20

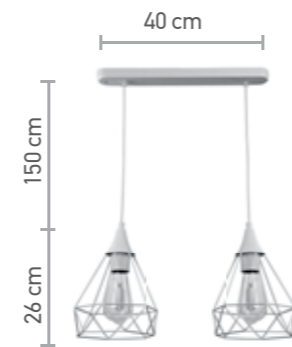

No 4024-2-WH/RAIL	
Bulb	2XE27
Material	Metal
Dimension	40cm x 176cm
Color	White
22-46-00	

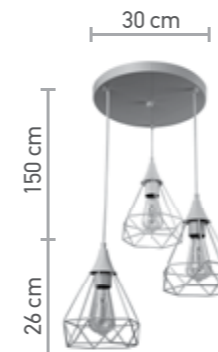

No 4024-3-WH/ROSETTE	
Bulb	3XE27
Material	Metal
Dimension	30cm x 176cm
Color	White
22-76-00	

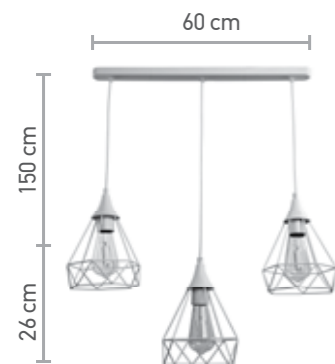

No 4024-3-WH/RAIL	
Bulb	3XE27
Material	Metal
Dimension	60cm x 176cm
Color	White
22-76-00	

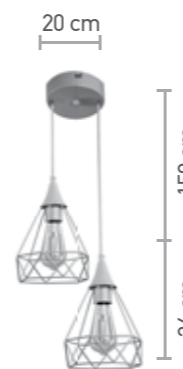

No 4024-2-WH/ROSETTE	
Bulb	2XE27
Material	Metal
Dimension	20cm x 176cm
Color	White
22-46-00	

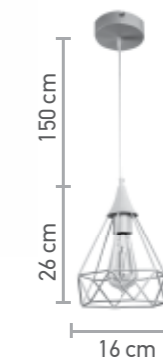

No 4024-WH	
Bulb	1XE27
Material	Metal
Dimension	26cm x 16cm
Color	White
22-18-00	



- Κρεμαστά φωτιστικά απο μέταλλο και ξύλο.
- Pendant lights in metal and wood.



GU10

IP20

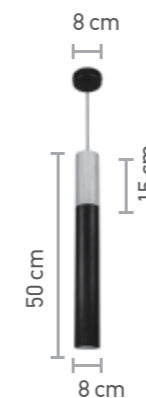

No	4017-BL	4017-WH
Bulb	1XGU10	1XGU10
Material	Metal & Wood	Metal & Wood
Dimension	15cm x 40cm	15cm x 40cm
Color	Black	White
	22-50-50	22-50-50



- Επιτραπέζιο μεταλλικό φωτιστικό.
- Table lamp in metal.

GU10 | IP20



No	3015-BL	3015-WH
Bulb	1xGU10	1xGU10
Material	Metal	Metal
Dimension	13cm x 33cm	13cm x 33cm
Color	Black	White
	22-37-00	22-37-00



LED

- Επίτοιχο φωτιστικό απο μέταλλο και υφασμάτινο καπέλο.
- Wall lamp in metal and fabric shade

 E27 | IP20 | 3000K | NON DIMMABLE

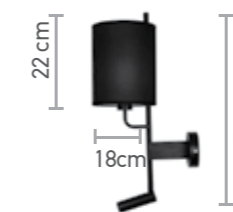

No	43028-BL	43028-WH
Power	3W LED	3W LED
Bulb	1XE27	1XE27
Color temperature	3000 K	3000 K
Material	Metal & Fabric	Metal & Fabric
Dimension	15cm x 40cm	15cm x 40cm
Color	Black	White
	22-87-00	22-87-00



- Φωτιστικά από λευκό μέταλλο.
- Lighting fixtures in white metal.

GU10 | IP20

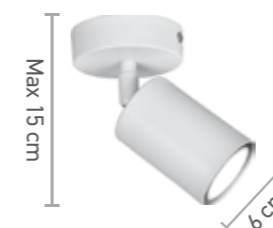

No 9086-1	
Bulb	1xGU10
Material	Metal
Dimension	6cm x 15cm
Color	White
22-12-50	

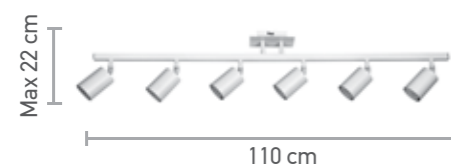

No 9086-6	
Bulb	6xGU10
Material	Metal
Dimension	110cm x 22cm
Color	White
22-99-00	

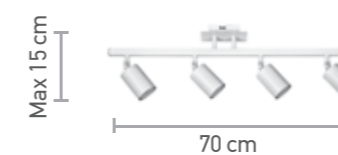

No 9086-4	
Bulb	4xGU10
Material	Metal
Dimension	70cm x 22cm
Color	White
22-65-00	



- Στρογγυλά κωνευτά σποτ.
- Round downlight spots.

GU10 | IP20



Cut: 7 cm

No	X0010-WH	X0010-BL
Bulb	1XGU10	1XGU10
Material	Metal	Metal
Dimension	8cm	8cm
Color	White	Black
	22-05-40	22-05-40

- Επίτοιχο φωτιστικό.
- Mounted Downlight spots.

GU10 | IP20



No	42025-WH	42025-BL
Bulb	1XGU10	1XGU10
Material	Aluminum & Metal	Aluminum & Metal
Dimension	7,8cm x 10cm	7,8cm x 10cm
Color	White	Black
	22-12-80	22-12-80

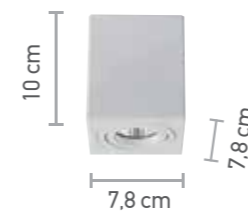

No	42026-WH	42026-BL
Bulb	1XGU10	1XGU10
Material	Aluminum & Metal	Aluminum & Metal
Dimension	7,8cm x 10cm	7,8cm x 10cm
Color	White	Black
	22-15-00	22-15-00





- Χωνευτά σποτ.
- Downlight spots.

 GU10 | **IP44**



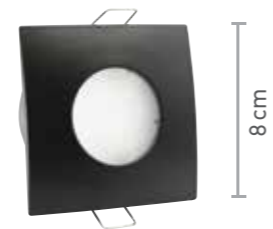

- Χωνευτά σποτ.
- Downlight spots.

 GU10 | **IP44**





Cut: 7 cm

No	X0009-BL	X0009-CH	X0009-WH
Bulb	1XGU10	1XGU10	1XGU10
Material	Metal	Metal	Metal
Dimension	8cm x 8cm	8cm x 8cm	8cm x 8cm
Color	Black 	Chrome 	White 
	22-07-20	22-07-20	22-07-20



Cut: 7 cm

No	X0008-BL	X0008-CH	X0008-WH
Bulb	1XGU10	1XGU10	1XGU10
Material	Metal	Metal	Metal
Dimension	8cm	8cm	8cm
Color	Black 	Chrome 	White 
	22-06-90	22-06-90	22-06-90





No	43037-WH	43037- BL
Power	3W LED	3W LED
Color temperature	3000K	3000K
Material	Metal	Metal
Dimension	6cm x 17cm	6cm x 17cm
Color	White	Black
22-39-00		



LED

- Επίτοιχα μεταλλικά φωτιστικά.
- Metal wall lamps

IP20 | 3000K | NON DIMMABLE |



No	43418-WH	43418- BL
Power	3W LED (front) 9W LED (back)	3W LED (front) 9W LED (back)
Color temperature	3000K	3000K
Material	Metal	Metal
Dimension	13cm x 13cm	13cm x 13cm
Color	White	Black
22-42-00		

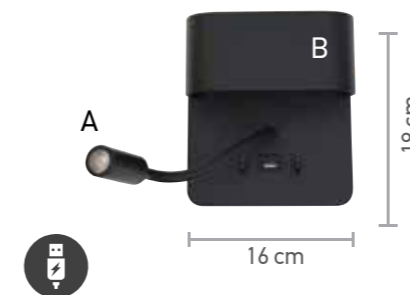

No 43036-BL	
Power	A - 3W LED B - 6W LED
Color temperature	3000K
Material	Metal
Dimension	16cm x 18cm
Color	Black
22-59-00	





- Επίτοιχα φωτιστικά από γύψο
- Wall lamps in plaster

IP20

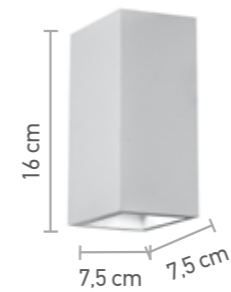

No 43033	
Bulb	2xGU10
Material	Plaster
Dimension	7,5cm x 16cm
22-23-00	

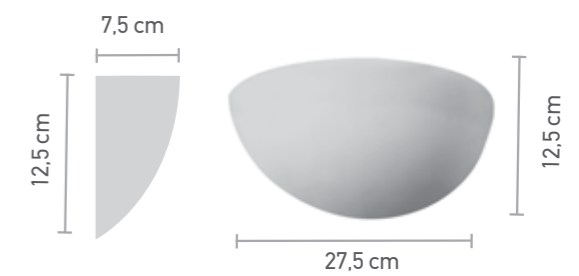

No 43032	
Bulb	1xE14
Material	Plaster
Dimension	27,5cm x 12,5cm
22-26-10	



- Φωτιστικά με καπέλο
- Lighting fixtures in shade.

 E27 | IP20



No 4036	
Bulb	1xE27
Material	Shade
Dimension	31cm x 23cm
22-28-50	



- Φωτιστικά με καπέλο
- Lighting fixtures in shade.

 E27 | IP20

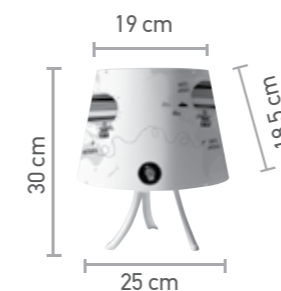

No 3024	
Bulb	1xE27
Material	Plastic & Shade
Dimension	25cm x 30cm
22-30-50	

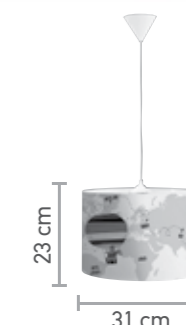

No 4034	
Bulb	1xE27
Material	Shade
Dimension	31cm x 23cm
22-28-50	

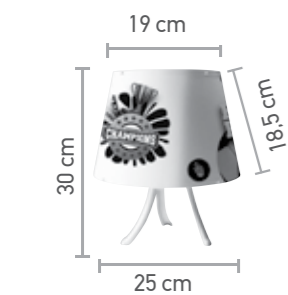

No 3026	
Bulb	1xE27
Material	Plastic & Shade
Dimension	25cm x 30cm
22-30-50	



- Φωτιστικά με καπέλο
- Lighting fixtures in shade.

 E27 | IP20

- Φωτιστικά με καπέλο
- Lighting fixtures in shade.

 E27 | IP20



No 4035	
Bulb	1xE27
Material	Shade
Dimension	31cm x 23cm
22-28-50	

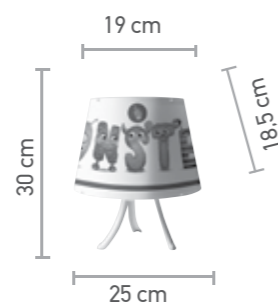

No 3025	
Bulb	1xE27
Material	Plastic & Shade
Dimension	25cm x 30cm
22-30-50	

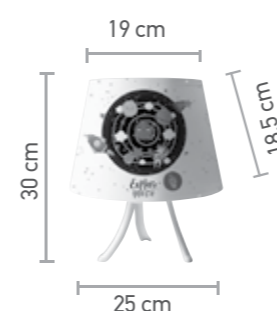

No 3028	
Bulb	1xE27
Material	Plastic & Shade
Dimension	25cm x 30cm
22-30-50	

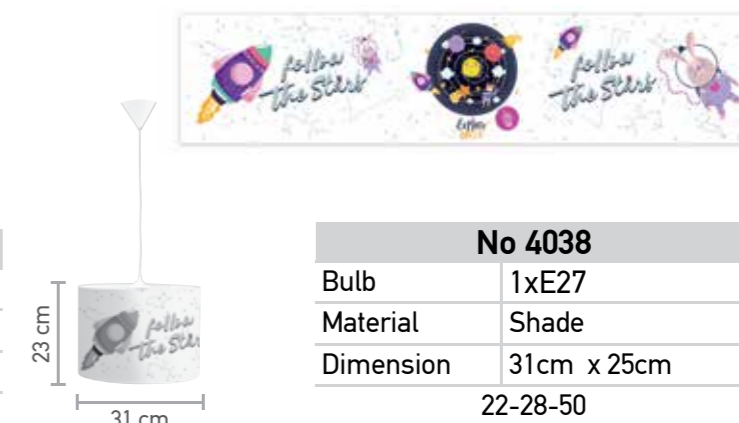

No 4038	
Bulb	1xE27
Material	Shade
Dimension	31cm x 25cm
22-28-50	



- Φωτιστικά με καπέλο
- Lighting fixtures in shade.

 E27 | IP20

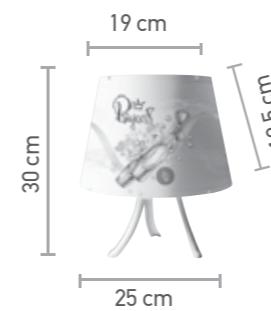

No 3027	
Bulb	1xE27
Material	Plastic & Shade
Dimension	25cm x 30cm
22-30-50	



No 4037	
Bulb	1xE27
Material	Shade
Dimension	31cm x 23cm
22-28-50	

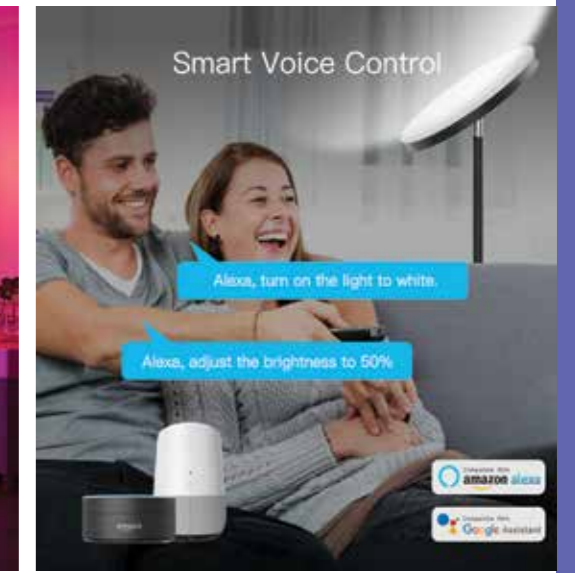
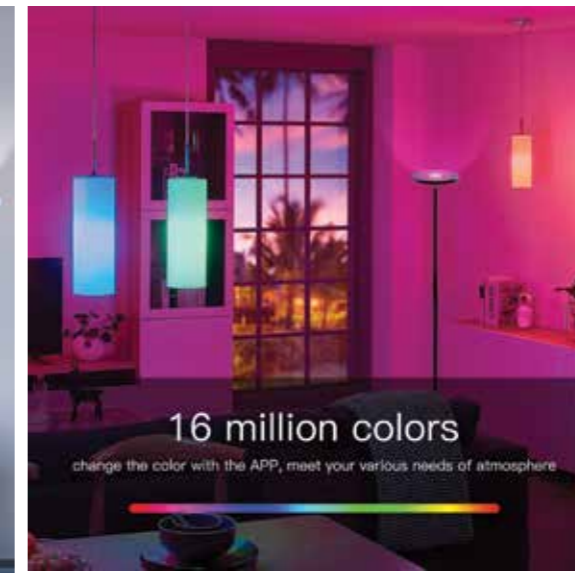

**10W WiFi LED Smart Bulb
RGB+CCT**



90° Flexible
angle light



1. Shortpress: On/Off
2. Long press: adjust the
brightness (1%~100%)



- 16 Million Colors**
RGBCW full color
- Dimmable**
Stepless adjusted
- Color Temperature**
2700K- 6500K
- Wattage**
10W
- Voltage**
190V-240V ,50/60Hz
- Base Type**
E27
- APP**
Magic Home APP
- Wireless Connection**
2.4GHz Wi-Fi



No	7.27.10.01.7
Power	10W
Lumen	800
Color temperature	RGBW by APP
	22-11-50

- 16 Million Colors**
RGBCW full color
- Dimmable**
Stepless adjusted
- Color Temperature**
2700K- 6500K
- Wattage**
24W
- Voltage**
190V-240V ,50/60Hz
- APP**
Magic Home APP
- Wireless Connection**
2.4GHz Wi-Fi

No	45023
Power	24W
Lumens	2000 Lm
Color temperature	RGB by APP & controler
Material	Metal acrylic
Dimension	25cm x 170cm
Color	Black
	22-135-50





E27 20.000h 360° 220V/240V IP20 RoHS CE

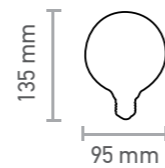

G95

No	7.27.08.25.1	7.27.08.42.1
Power	8W	8W
Lumen	650	650
Dimmable	YES	NO
Color temperature	2200K WARM	2200K WARM
	22-07-60	22-07-10

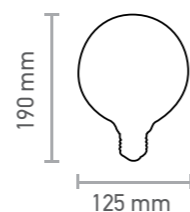

G125

No	7.27.10.28.1
Power	10W
Lumen	900
Dimmable	YES
Color temperature	2200K WARM
	22-10-30



CE RoHS IP20 220V/240V 360° 20.000h

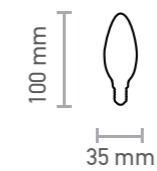

C35/E14

No	7.14.05.20.1	7.14.05.40.1
Power	5W	5W
Lumen	400	400
Dimmable	YES	NO
Color temperature	2200K WARM	2200K WARM
	22-03-20	22-02-50

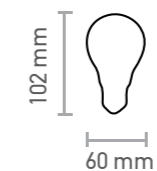

A60/E27

No	7.27.08.23.1	7.27.08.41.1
Power	8W	8W
Lumen	650	650
Dimmable	YES	NO
Color temperature	2200K WARM	2200K WARM
	22-04-50	22-04-00

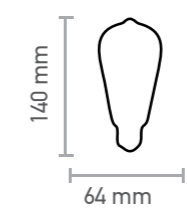

ST64/E27

No	7.27.08.24.1
Power	8W
Lumen	650
Dimmable	YES
Color temperature	2200K WARM
	22-05-90



**C35**

No	7.14.06.17.1
Power	6W
Lumen	800
Dimmable	NO
Color temperature	2700K WARM
	22-03-10

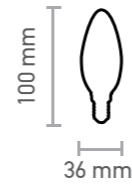

No	7.14.05.17.2	7.14.05.16.1	7.14.05.17.1
Power	5W	5W	5W
Lumen	500	450	450
Dimmable	NO	YES	NO
Color temperature	4000K NEUTRAL	2700K WARM	2700K WARM
	22-02-20	22-02-90	22-02-20

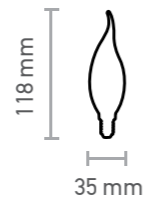
**C37L**

No	7.14.06.18.1
Power	6W
Lumen	800
Dimmable	NO
Color temperature	2700K WARM
	22-03-10

**G45/E14**

No	7.14.06.19.1
Power	6W
Lumen	800
Dimmable	NO
Color temperature	2700K WARM
	22-03-10

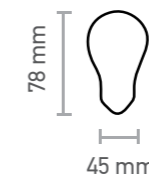
**G45/E27**

No	7.27.06.13.1
Power	6W
Lumen	800
Dimmable	NO
Color temperature	2700K WARM
	22-03-10



No	7.27.05.13.2
Power	5W
Lumen	500
Dimmable	NO
Color temperature	4000K NEUTRAL
	22-02-20

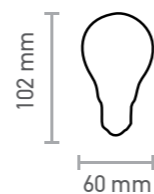

No	7.27.10.22.1	7.27.10.18.1
Power	10W	10W
Lumen	1200	1200
Dimmable	NO	YES
Color temperature	2700K WARM	2700K WARM
	22-04-20	22-05-30
No	7.27.10.22.2	7.27.10.18.2
Power	10W	10W
Lumen	1200	1200
Dimmable	NO	YES
Color temperature	4000K NEUTRAL	4000K NEUTRAL
	22-04-20	22-05-30

ST64

No	7.27.08.26.1
Power	8W
Lumen	800
Dimmable	NO
Color temperature	2700K WARM
	22-04-70

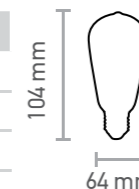

No	7.27.10.26.1	7.27.10.26.2
Power	10W	10W
Lumen	1200	1200
Dimmable	NO	NO
Color temperature	2700K WARM	4000K NEUTRAL
	22-05-10	22-05-10

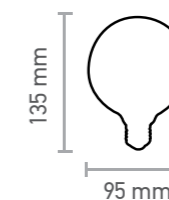
**G95**

No	7.27.08.16.1	7.27.08.21.1
Power	8W	8W
Lumen	720	800
Dimmable	YES	NO
Color temperature	2700K WARM	2700K WARM
	22-06-80	22-05-80



No	7.27.12.21.2	7.27.12.21.1
Power	12W	12W
Lumen	1500	1500
Dimmable	NO	NO
Color temperature	4000K NEUTRAL	2700K WARM
	22-07-30	22-07-30



E27 20.000h 360° 220V/240V IP20 RoHS CE

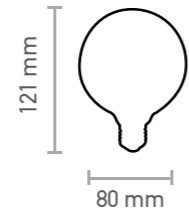

G80

No	7.27.08.39.1
Power	8W
Lumen	800
Dimmable	NO
Color temperature	2700K WARM
	22-05-20

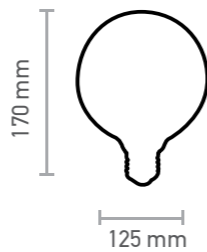

G125

No	7.27.12.27.1
Power	12W
Lumen	1500
Dimmable	NO
Color temperature	2700K WARM
	22-09-90



CE RoHS IP20 220V/240V 180° 25.000h E27

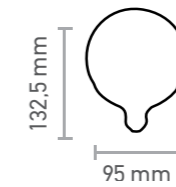

G95

No	7.27.15.14.1	7.27.15.14.2	7.27.15.14.3
Power	13W	13W	13W
Lumen	1200	1200	1200
Dimmable	NO	NO	NO
Color temperature	3000K WARM	4000K NEUTRAL	6500K COOL
	22-05-30	22-05-30	22-05-30

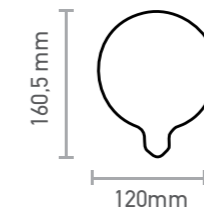

G120

No	7.27.18.14.1	7.27.18.14.2	7.27.18.14.3
Power	18,5W	18,5W	18,5W
Lumen	1600	1600	1600
Dimmable	NO	NO	NO
Color temperature	3000K WARM	4000K NEUTRAL	6500K COOL
	22-07-80	22-07-80	22-07-80



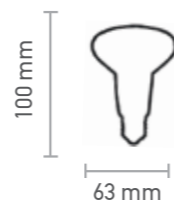

R63

No	7.27.08.08.1	7.27.08.08.2	7.27.08.08.3
Power	8W	8W	8W
Lumen	680	680	680
Dimmable	NO	NO	NO
Color temperature	3000K WARM	4000K NEUTRAL	6500K COOL
	22-02-30	22-02-30	22-02-30



Day/Night & Motion Sensor

No	7.27.12.44.1	7.27.12.44.2
Power	12W	12W
Lumen	800	800
Dimmable	NO	NO
Color temperature	3000K WARM	4000K NEUTRAL
	22-07-60	22-07-60



A70

No	7.27.18.04.1	7.27.18.04.2	7.27.18.04.3
Power	18W	18W	18W
Lumen	1800	1800	1800
Dimmable	NO	NO	NO
Color	3000K WARM	4000K NEUTRAL	6500K COOL
	22-03-50	22-03-50	22-03-50



Day/Night Sensor

No	7.27.09.43.1	7.27.09.43.2
Power	9W	9W
Lumen	800	800
Dimmable	NO	NO
Color temperature	3000K WARM	4000K NEUTRAL
	22-05-80	22-05-80



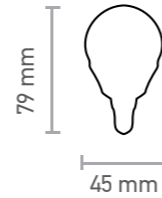

E14 25.000h 160° 220V/240V IP20 RoHS CE

**G45**

No	7.14.05.14.1	7.14.05.14.2	7.14.05.14.3
Power	5.5W	5.5W	5.5W
Lumen	470	470	470
Dimmable	NO	NO	NO
Color temperature	3000K WARM	4000K NEUTRAL	6500K COOL
	22-01-60	22-01-60	22-01-60
No	7.14.08.14.1	7.14.08.14.2	7.14.08.14.3
Power	8W	8W	8W
Lumen	700	700	700
Dimmable	NO	NO	NO
Color temperature	3000K WARM	4000K NEUTRAL	6500K COOL
	22-01-80	22-01-80	22-01-80

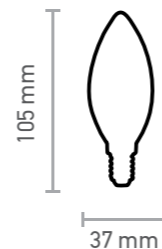
**C37**

No	7.14.05.13.1	7.14.05.13.2	7.14.05.13.3
Power	5.5W	5.5W	5.5W
Lumen	470	470	470
Dimmable	NO	NO	NO
Color temperature	3000K WARM	4000K NEUTRAL	6500K COOL
	22-01-60	22-01-60	22-01-60

C37/E14

No	7.14.08.13.1	7.14.08.13.2	7.14.08.13.3
Power	8W	8W	8W
Lumen	700	700	700
Dimmable	NO	NO	NO
Color temperature	3000K WARM	4000K NEUTRAL	6500K COOL
	22-01-80	22-01-80	22-01-80



CE RoHS IP20 220V/240V 360° 20.000h E27

**G45**

No	7.27.05.12.1	7.27.05.12.2	7.27.05.12.3
Power	5.5W	5.5W	5.5W
Lumen	470	470	470
Dimmable	NO	NO	NO
Color temperature	3000K WARM	4000K NEUTRAL	6500K COOL
	22-01-60	22-01-60	22-01-60

No	7.27.08.12.1	7.27.08.12.2	7.27.08.12.3
Power	8W	8W	8W
Lumen	700	700	700
Dimmable	NO	NO	NO
Color temperature	3000K WARM	4000K NEUTRAL	6500K COOL
	22-01-80	22-01-80	22-01-80

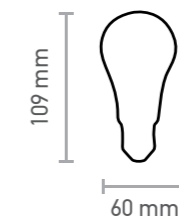
**A60**

No	7.27.15.04.1	7.27.15.04.2	7.27.15.04.3
Power	15W	15W	15W
Lumen	1500	1500	1500
Dimmable	NO	NO	NO
Color temperature	3000K WARM	4000K NEUTRAL	6500K COOL
	22-02-70	22-02-70	22-02-70

No	7.27.12.03.1	7.27.12.03.2	7.27.12.03.3
Power	12W	12W	12W
Lumen	1055	1055	1055
Dimmable	NO	NO	NO
Color temperature	3000K WARM	4000K NEUTRAL	6500K COOL
	22-02-20	22-02-20	22-02-20





GU10 25.000h 220V/240V IP20 RATED RoHS CE

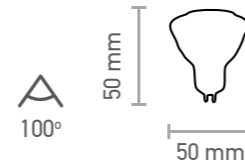

No	7.10.05.09.1	7.10.05.09.2	7.10.05.09.3
Power	5,5W	5,5W	5,5W
Lumen	420	420	420
Dimmable	NO	NO	NO
Color temperature	3000K WARM	4000K NEUTRAL	6500K COOL
	22-01-70	22-01-70	22-01-70



No	7.10.08.10.1	7.10.08.10.2	7.10.08.10.3
Power	8W	8W	8W
Lumen	640	640	640
Dimmable	NO	NO	NO
Color temperature	3000K WARM	4000K NEUTRAL	6500K COOL
	22-01-90	22-01-90	22-01-90

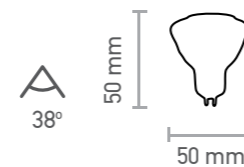

No	7.10.08.09.1	7.10.08.09.2
Power	8W	8W
Lumen	640	640
Dimmable	NO	NO
Color temperature	3000K WARM	4000K NEUTRAL
	22-02-10	22-02-10

CE RoHS IP20 220V/240V 360° 25.000h G9

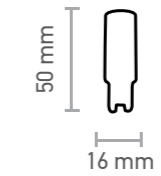

No	7.09.03.09.1	7.09.03.09.2	7.09.03.09.3
Power	3,5W	3,5W	3,5W
Lumen	350	350	350
Dimmable	NO	NO	NO
Color temperature	3000K WARM	4000K NEUTRAL	6500K COOL
	22-02-40	22-02-40	22-02-40

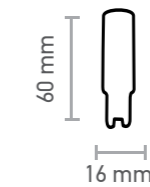

No	7.09.06.09.1	7.09.06.09.2	7.09.06.09.3
Power	6W	6W	6W
Lumen	550	550	550
Dimmable	NO	NO	NO
Color temperature	3000K WARM	4000K NEUTRAL	6500K COOL
	22-02-90	22-02-90	22-02-90

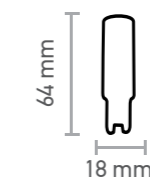

No	7.09.08.09.1	7.09.08.09.2	7.09.08.09.3
Power	8W	8W	8W
Lumen	750	750	750
Dimmable	NO	NO	NO
Color temperature	3000K WARM	4000K NEUTRAL	6500K COOL
	22-03-80	22-03-80	22-03-80



No	7.09.10.09.1	7.09.10.09.2	7.09.10.09.3
Power	10W	10W	10W
Lumen	950	950	950
Dimmable	NO	NO	NO
Color temperature	3000K WARM	4000K NEUTRAL	6500K COOL
	22-04-00	22-04-00	22-04-00



NON DIMMABLE 20.000h 160° 170V 265V WHITE ALUMINUM IP20 RoHS CE

CE RoHS IP20 170V 265V WHITE ALUMINUM 160° 20.000h NON DIMMABLE

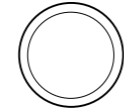

22,5 cm
Cut: 20,6 x 20,6 cm

No	2.20.02.1	2.20.02.2	2.20.02.3
Power	20	20	20
Lumen	1700	1700	1700
Color temperature	3000K WARM	4000K NEUTRAL	6500K COOL
Dimension	22,5cm	22,5cm	22,5cm
	22-06-70	22-06-70	22-06-70

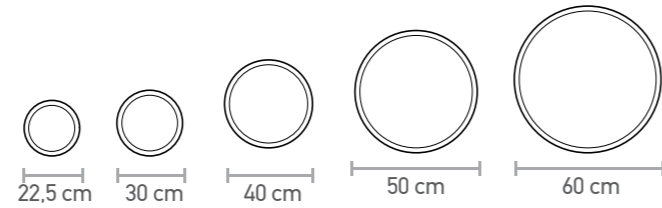

No	2.20.04.1	2.20.04.2
Power	20	20
Lumen	1700	1700
Color	3000K WARM	4000K NEUTRAL
Dimension	22,5	22,5
	22-10-50	22-10-50

No	2.24.04.2	2.30.04.2
Power	24	30
Lumen	2200	2500
Color	4000K NEUTRAL	4000K NEUTRAL
Dimension	30cm	40cm
	22-11-90	22-27-50

No	2.36.04.2	2.48.04.2
Power	36	48
Lumen	3400	4500
Color	4000K NEUTRAL	4000K NEUTRAL
Dimension	50cm	60cm
	22-46-00	22-55-70

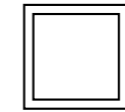

22,5 cm
Cut: 20,6 x 20,6 cm

No	2.20.01.1	2.20.01.2	2.20.01.3
Power	20	20	20
Lumen	1700	1700	1700
Color temperature	3000K WARM	4000K NEUTRAL	6500K COOL
Dimension	22,5cm	22,5cm	22,5cm
	22-09-80	22-09-80	22-09-80

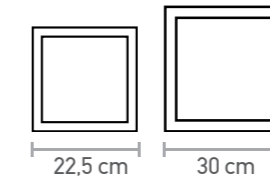

No	2.20.03.1	2.20.03.2	2.24.03.2
Power	20	20	20
Lumen	1700	1700	2400
Color temperature	3000K WARM	4000K NEUTRAL	4000K NEUTRAL
Dimension	22,5cm	22,5cm	30cm
	22-11-10	22-11-10	22-12-50





NON DIMMABLE 25.000h 360° 170V 265V WHITE ALUMINUM IP20 RoHS CE

CE RoHS IP20 170V 265V WHITE ALUMINUM 360° 25.000h NON DIMMABLE BACKLIGHT

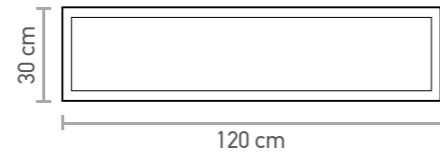

Cut: 119,5 x 29,5 cm

No	2.50.01.2
Power	48W
Lumen	4500
Color temperature	4000K NEUTRAL
Dimension	120x30cm
	22-41-40

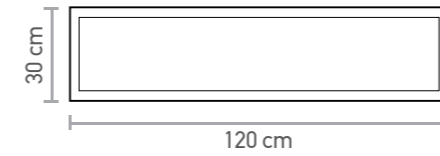

Cut: 119,5 x 29,5 cm

No	2.48.03.2
Power	48W
Lumen	4500
Color temperature	4000K NEUTRAL
Dimension	120x30cm
	22-36-10

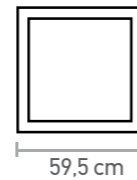

No	2.48.01.1	2.48.01.2	2.48.01.3
Power	48W	48W	48W
Lumen	4500	4500	4500
Color temperature	3000K WARM	4000K NEUTRAL	6500K COOL
Dimension	59,5cm	59,5cm	59,5cm
	22-36-10	22-36-10	22-36-10



No	2.48.02.2
Power	48W
Lumen	4500
Color temperature	4000K NEUTRAL
Dimension	59,5cm
	22-28-90





No	BAPAN 001
wires hanging for LED panel 60X60 and 120X30	
22-05-20	

No	METPAN 020	METPAN 024
Watt	20	24
Dimmable	NO	NO
	22-02-00	22-02-90

No	METPAN 030	METPAN 036	METPAN 048
Watt	30	36	48
Dimmable	NO	NO	NO
	22-03-70	22-04-30	22-05-90

No	METPAN 020 DIM	METPAN 048 DIM
Watt	20	48
Dimmable	YES	YES
	22-12-00	22-48-00



No	BAPAN 004
clips for recessed installation for 2.50.01.2 & 2.48.03.2	
22-01-50	

No	BAPAN 005
clips for recessed installation for 2.48.01.1/2/3 & 2.48.02.2	
22-02-20	

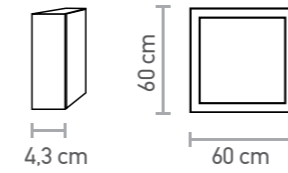

No	BAPAN 002
mounted frame for 2.48.01.1/2/3	
22-12-30	

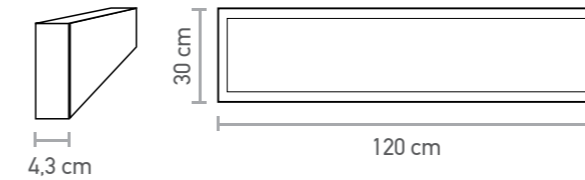

No	BAPAN 003
mounted frame for 2.50.01.2	
22-14-90	

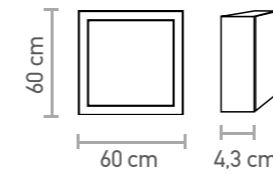

No	BAPAN 006
mounted frame for 2.48.02.2 & 2.48.01.1/2/3	
22-14-90	

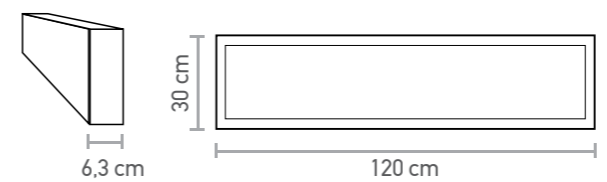

No	BAPAN 007
mounted frame for 2.48.03.2 & 2.50.01.2	
22-17-50	



Contents

2.20.01.1	153	2.48.03.2	155
2.20.01.2	153	2.48.04.2	152
2.20.01.3	153	2.50.01.2	154
2.20.02.1	152	3015-BL	117
2.20.02.2	152	3015-WH	117
2.20.02.3	152	3016-BL	87
2.20.03.1	153	3017-CH	88
2.20.03.2	153	3017-GL	90
2.20.04.1	152	3018-BL	85
2.20.04.2	152	3019-BL	68
2.24.03.2	153	3020	56
2.24.04.2	152	3024	131
2.30.04.2	152	3025	132
2.36.04.2	152	3026	130
2.48.01.1	154	3027	134
2.48.01.2	154	3028	133
2.48.01.3	154	4016-1	93
2.48.02.2	155	4016-3/RAIL	93

Contents

4016-3/ROSETTE	92	4024-2-WH/ROSETTE	113	4034	131	42023-A Black	75
4016-4/RAIL	93	4024-3-BL/RAIL	111	4035	132	42023-A White	75
4016-4/ROSETTE	92	4024-3-BL/ROSETTE	110	4036	130	42023-B Black	75
4017-BL	115	4024-3-WH/RAIL	112	4037	135	42023-B White	75
4017-WH	115	4024-3-WH/ROSETTE	113	4038	133	42024-A Golden	74
4018-BL	65	4024-BL	110	42014	72	42024-B Golden	74
4018-WH	65	4024-WH	113	42015	73	42025-BL	123
4019-GL	65	4025A	104	42016-A	71	42025-WH	123
4020-BL	85	4025B	104	42016-B	71	42026-BL	123
4021-BL	87	4026A	104	42016-C	71	42026-WH	123
4022- CH	89	4026B	105	42018	78	42027-BL	67
4022- GL	90	4027A	107	42019	79	42028-CH	67
4023-BL	86	4027B	107	42020-A Black	77	42028-GL	67
4023-CH	89	4028A	109	42020-A White	77	43028-BL	119
4023-GL	90	4028B	109	42020-B Black	77	43028-WH	119
4024-2-BL/RAIL	111	4029A	103	42020-B White	77	43029-A	69
4024-2-BL/ROSETTE	110	4029B	102	42021-A Golden	76	43029-B	69
4024-2-WH/RAIL	112	4030	101	42021-B Golden	76	43030- BL	86

Contents

43030- BL	88	6041-120-BL	43
43031-GL	91	6041-60-BL	43
43032	129	6041-80-BL	43
43033	129	6042-120-BL	43
43034	57	6042-180-BL	36
43035	95	6042-90-BL	36
43036-BL	127	6043	36
43037- BL	127	6044	58
43037-WH	127	6045	44
43418- BL	126	6046	46
43418-WH	126	6047	47
45015-BL	87	6048-BL	45
45016-CH	89	6049-CH	51
45016-GL	91	6049-GL	51
45019-BL	68	6050-BL	51
45022	57	6051-CH	49
45023	137	6051-GL	49
6041-100-BL	43	6052-BL	49

Contents

6053-BL	53	6068-8	97	7.09.03.09.3	151	7.14.05.13.1	148
6054-GL	53	6069-12	95	7.09.06.09.1	151	7.14.05.13.2	148
6055-BL	52	6171-100-BL	40	7.09.06.09.2	151	7.14.05.13.3	148
6056-GL	52	6171-100-WH	41	7.09.06.09.3	151	7.14.05.14.1	148
6057-BL	60	6171-120-BL	40	7.09.08.09.1	151	7.14.05.14.2	148
6058-BL	61	6171-120-WH	41	7.09.08.09.2	151	7.14.05.14.3	148
6059-CH	63	6171-60-BL	40	7.09.08.09.3	151	7.14.05.16.1	140
6059-GL	63	6171-60-WH	41	7.09.10.09.1	151	7.14.05.17.1	140
6060-BL	83	6171-80-BL	40	7.09.10.09.2	151	7.14.05.17.2	140
6061-BL	83	6171-80-WH	41	7.09.10.09.3	151	7.14.05.20.1	139
6062-BL	82	6172-120-BL	37	7.10.05.09.1	150	7.14.05.40.1	139
6063	81	6172-120-WH	39	7.10.05.09.2	150	7.14.06.17.1	140
6064 - BL	84	6172-180-BL	37	7.10.05.09.3	150	7.14.06.18.1	140
6065-BL	54	6172-180-WH	39	7.10.08.09.1	150	7.14.06.19.1	141
6066-CH	54	6172-90-BL	37	7.10.08.09.2	150	7.14.08.13.1	148
6066-GL	54	6172-90-WH	39	7.10.08.10.1	150	7.14.08.13.2	148
6068-12	99	7.09.03.09.1	151	7.10.08.10.2	150	7.14.08.13.3	148
6068-4	97	7.09.03.09.2	151	7.10.08.10.3	150	7.14.08.14.1	148

Contents

7.14.08.14.2	148	7.27.08.26.1	143
7.14.08.14.3	148	7.27.08.39.1	144
7.27.05.12.1	149	7.27.08.41.1	139
7.27.05.12.2	149	7.27.08.42.1	138
7.27.05.12.3	149	7.27.09.43.1	147
7.27.05.13.2	141	7.27.09.43.2	147
7.27.06.13.1	141	7.27.10.01.7	136
7.27.08.08.1	146	7.27.10.18.1	142
7.27.08.08.2	146	7.27.10.18.2	142
7.27.08.08.3	146	7.27.10.22.1	142
7.27.08.12.1	149	7.27.10.22.2	142
7.27.08.12.2	149	7.27.10.26.1	143
7.27.08.12.3	149	7.27.10.26.2	143
7.27.08.16.1	143	7.27.10.28.1	138
7.27.08.21.1	143	7.27.12.03.1	149
7.27.08.23.1	139	7.27.12.03.2	149
7.27.08.24.1	139	7.27.12.03.3	149
7.27.08.25.1	138	7.27.12.21.1	149

7.27.12.21.2	143
7.27.12.27.1	144
7.27.12.44.1	147
7.27.12.44.2	147
7.27.15.04.1	149
7.27.15.04.2	149
7.27.15.04.3	149
7.27.15.14.1	145
7.27.15.14.2	145
7.27.15.14.3	145
7.27.18.04.1	146
7.27.18.04.2	146
7.27.18.04.3	146
7.27.18.14.1	145
7.27.18.14.2	145
7.27.18.14.3	145
9086-1	121
9086-4	121

Contents

9086-6	121
BAPAN 001	156
BAPAN 002	157
BAPAN 003	157
BAPAN 004	156
BAPAN 005	156
BAPAN 006	157
BAPAN 007	157
L001-BL	38
L001-WH	38
L002-BL	38
L002-WH	38
L003-120-BL	38
L003-120-WH	38
L003-180-BL	38
L003-180-WH	38
L003-90-BL	38
L003-90-WH	38

L004-BL	38
METPAN 020	158
METPAN 020 DIM	158
METPAN 024	158
METPAN 030	158
METPAN 036	158
METPAN 048	158
METPAN 048 DIM	158
T00101-BL	31
T00101-WH	30
T00102-BL	31
T00102-WH	30
T00201-BL	31
T00201-WH	30
T00202-BL	31
T00202-WH	30
T00300-BL	27
T00300-WH	27

T00401-BL	28
T00401-WH	29
T00402-BL	28
T00402-WH	29
T00501-BL	28
T00501-WH	29
T00502-BL	28
T00502-WH	29
T00600-BL	26
T00600-WH	27
T00700-BL	26
T00700-WH	27
T00801-BL	23
T00802-BL	23
T00901-BL	22
T00902-BL	22
T01001-BL	23
T01002-BL	23

Contents

T01100-BL	25	T02101-BL	19
T01200-BL	25	T02102-BL	19
T01301-BL	15	T02301-BL	17
T01302-BL	15	T02302-BL	17
T01401-BL	15	T02401-BL	17
T01402-BL	15	T02402-BL	17
T01501-BL	15	T02501-BL	16
T01502-BL	15	T02502-BL	16
T01601-BL	15	T02601-BL	32
T01602-BL	15	T02601-WH	32
T01701-BL	14	T02602-BL	32
T01702-BL	14	T02602-WH	32
T01801-BL	14	T02701-BL	33
T01802-BL	14	T02701-WH	33
T01901-BL	18	T02702-BL	33
T01902-BL	18	T02702-WH	33
T02001-BL	19	TC001-BL	35
T02002-BL	19	TC001-WH	35

Contents

TC002-BL	0	TC016	21	X0008-WH	125
TC002-WH	0	TC017	21	X0009-BL	124
TC003-BL	0	TC018	21	X0009-CH	124
TC003-WH	0	TC019	21	X0009-WH	124
TC004	0	TC020	21	X0010-BL	122
TC005-BL	0	TC021	21	X0010-WH	122
TC005-WH	0	TD001	21		
TC006-BL	0	TD002	21		
TC006-WH	0	TR001-BL	34		
TC008-BL	0	TR001-WH	34		
TC008-WH	0	TR002-BL	34		
TC009-BL	0	TR002-WH	34		
TC010-BL	0	TR003-BL	24		
TC011-BL	0	TR004-BL	24		
TC012-BL	0	TR005	21		
TC013-BL	0	TR006	21		
TC014	0	X0008-BL	125		
TC015-BL	0	X0008-CH	125		

ΜΩΡΑΙΤΗΣ ΦΩΤΙΣΤΙΚΑ ΑΒΕΕ
ΒΙΟΜ. & ΕΜΠΟΡΙΚΗ ΕΤΑΙΡΕΙΑ

Όθωνος 46, Αγ. Δημήτριος -Αθήνα
Τηλ. 210 9760472, 210 9702003 - Fax: 210
9702003

MORAITIS LIGHTS S.A.
IMPORT - EXPORTS

46 Othonos Str. Agios Dimitrios - Athens, Greece

www.moraitis.com

info@moraitis.com
sales@moraitis.com
accounting@moraitis.com

Εθνική Τράπεζα 1154 7027 943
IBAN: GR51 0110 1150 0000 1154 7027 943

Τράπεζα Πειραιώς 65 5514 7497 354
IBAN: GR96 0171 5550 0065 5514 7497 354

Alpha Bank 1560 0200 2014 154
IBAN: GR14 0140 1560 1560 0200 2014 154



InLight

Ένας κόσμος γεμάτος φως

2022-2023