

rabalux[®]

New Products

Autumn 2023



CONTENTS • TARTALOMJEGYZÉK • INHALTSVERZEICHNIS

01

CEILING LAMPS
Mennyezeti lámpák
Deckenleuchten

3-11

02

GLASS LAMPS
Üveg lámpák
Giaslampen

12-25

03

LED LIGHTS
LED lámpák
LED Deckenleuchten

26-33

04

INDUSTRIAL
Indusztriális
Industrial

34-39

05

**FLOOR-,
TABLE LAMPS,
DECORATIVE
LAMPS**
Álló-, asztali
és dekor lámpák
Steh-, Tischlampen
und Dekorleuchten

40-45

06

DATA
Adatok
Daten

46-51



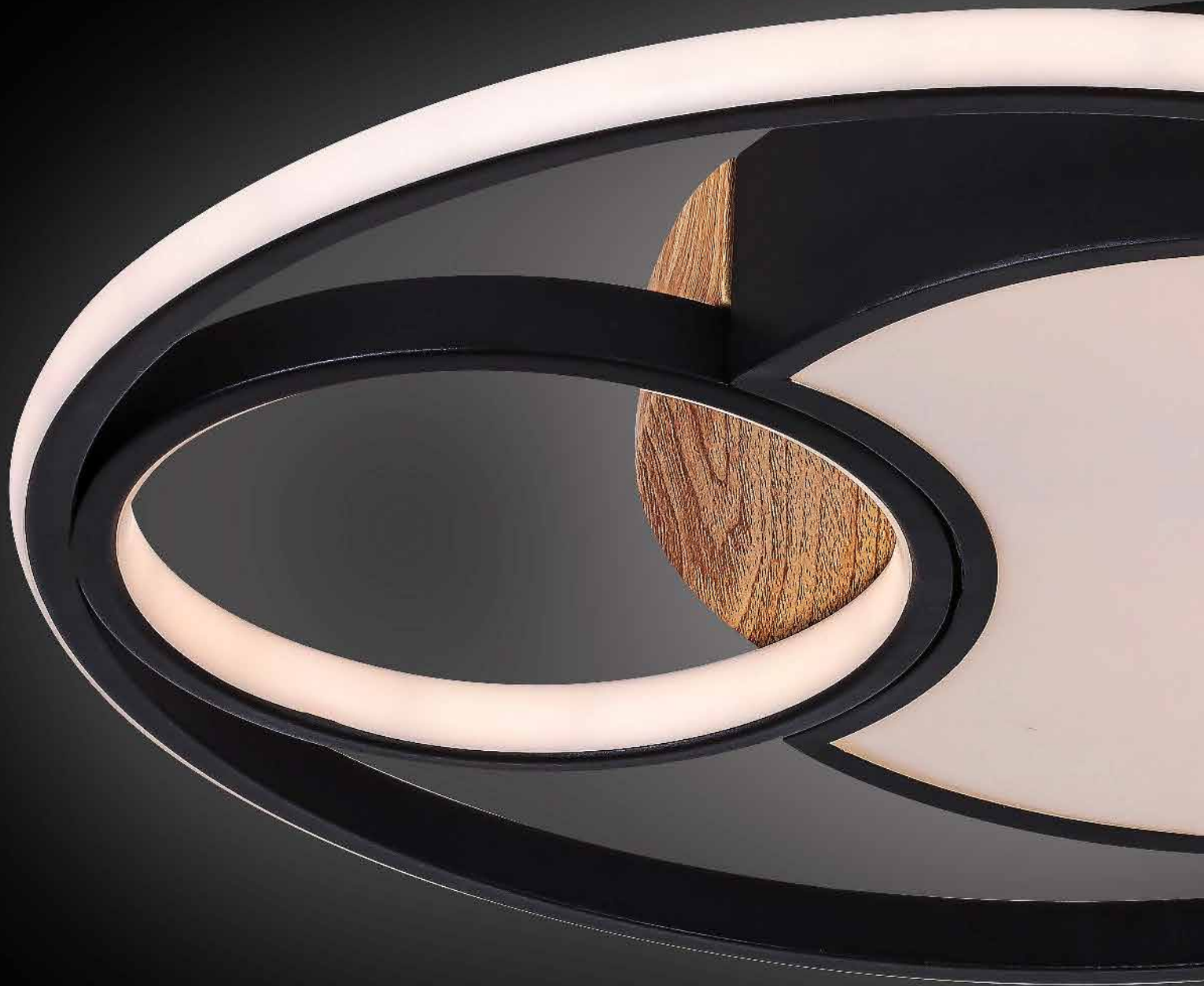

01

CEILING LAMPS

MENNYEZETI LÁMPÁK

DECKENLEUCHTEN

71044

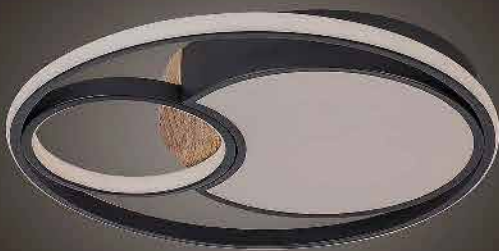
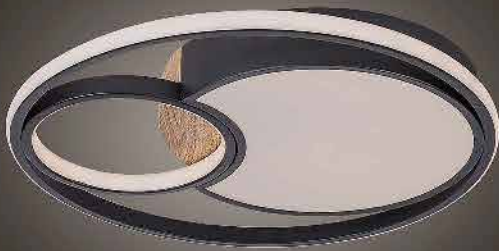
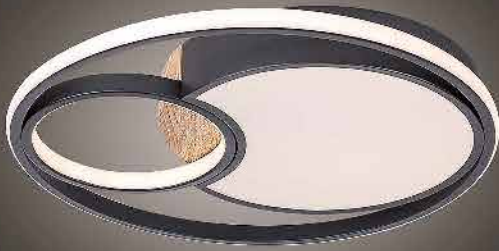

LEOLA



71044

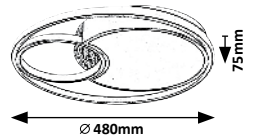

ARILD



71146

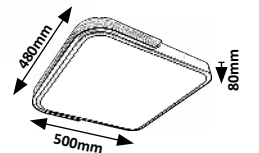

71044 (M) (P)

LED / 81W (83800lm, 9100lm; 3000K-6000K) incl.
IP20 • 20032 • 571
matte black/beechnwhite



5 996595 710446

71146 (M) (P)

LED / 48W (1850lm, 3800lm; 3000K-6500K) incl.
IP20 • 20034 • 573
matte black/white



5 996595 711467

GANDOR



71141

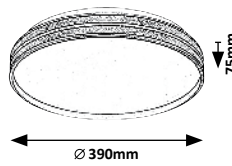

LIATRIS



71029

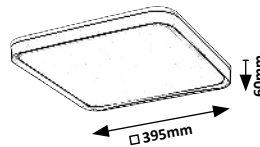

71141



71141

MP

LED / 24W (1850lm, 2400lm;
3000K-6500K) incl.
IP20 • 20028 • 546
matte black/gold/white



5 996595 711412

71029

MP

LED / 26W (1450lm, 2880lm;
3000K) incl.
IP20 • 20023
grey/gold/white



5 996595 710293



FONTANA



71159

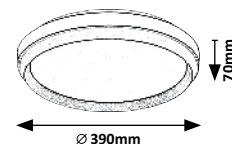

71159 (M) (P)

LED / 24W
(1100lm, 2600lm;
3000K) incl. • IP20 • 20043
brown/matte white



5 996595 711597

DETTORA



71046

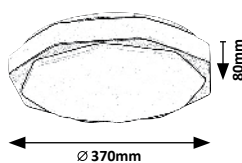

71046 **M P**

LED / 18W (1150lm, 1900lm);
3000K-6000K incl.
IP20 • 20025 • 581
grey/white



5 996595 710460



71140

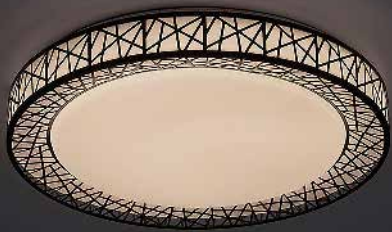

NILIN

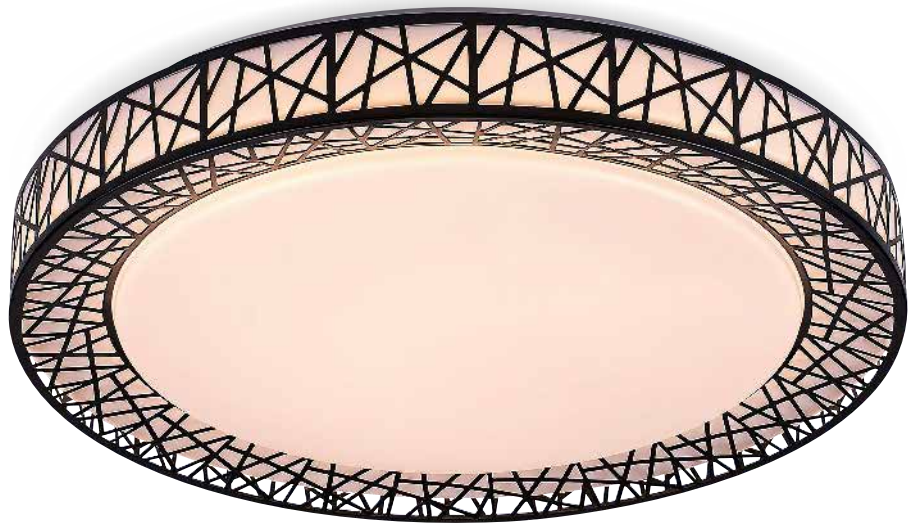

71140

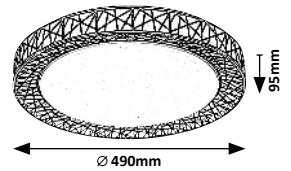

71140 **(M P)**

LED / 48W (3400lm, 4900lm;
3000K-6500K) incl.
IP20 • 20027 • 546
matte black/white



5 996595 711405

KONTE



71142

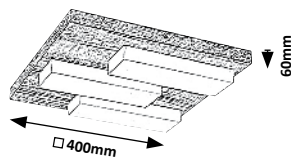

71142 **M** **W** **AC**

LED / 30W
(1800lm, 3000lm;
3000K) incl. • IP20
oak/white



5 996595 711429



EZIO

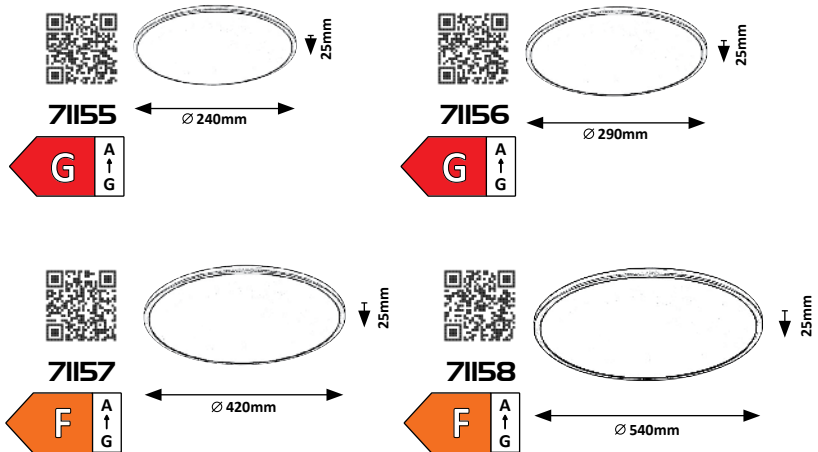

71155 (P)

LED / 15W
 (1200lm, 1650lm;
 3000K) incl. • IP20
 matte black/matte white



5 996595 711559

71156 (P)

LED / 18W
 (1400lm, 2000lm;
 3000K) incl. • IP20
 matte black/matte white



5 996595 711566

71157 (P)

LED / 22W
 (2000lm, 2650lm;
 3000K) incl. • IP20
 matte black/matte white



5 996595 711573

71158 (P)

LED / 36W
 (3600lm, 4800lm;
 3000K) incl. • IP20
 matte black/matte white



5 996595 711580

NABIL



71148

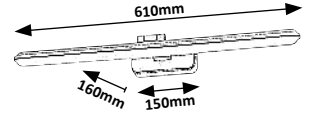

71147

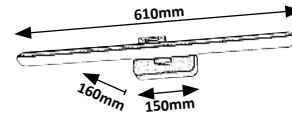

71147



LED / 15W
 (830lm, 1550lm;
 4000K) incl. • IP20 • 20037
 matte black/white



5 996595 711474

71148



LED / 15W
 (1100lm, 1750lm;
 4000K) incl. • IP20 • 20037
 matte white



5 996595 711481



02

GLASS LAMPS

ÜVEG LÁMPÁK

GLASLAMPEN

SALVATORE

TEXTILE
CABLE

designed by
rabalux

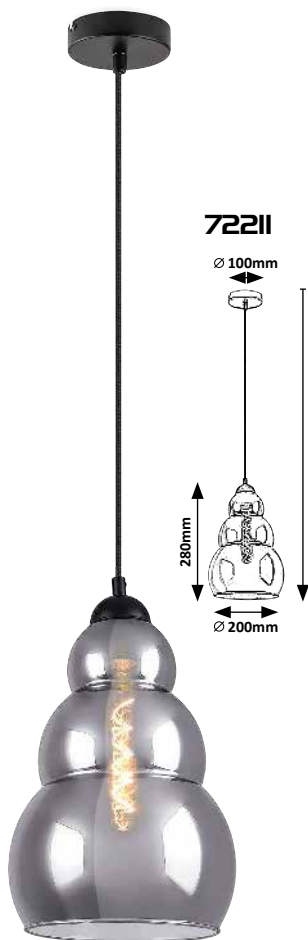

7221I

Ø 100mm

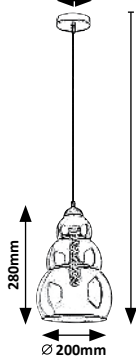

280mm

Ø 200mm



7221B

Ø 350mm

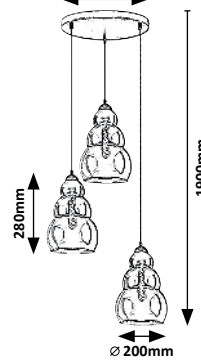

280mm

Ø 200mm

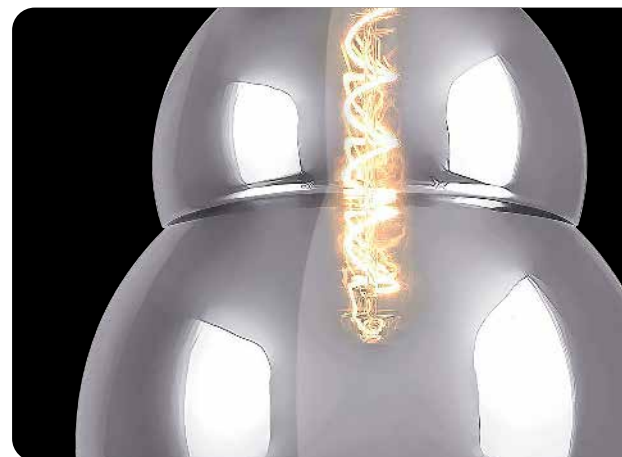

7221I **MG**

☒ E27 / 1x max. 40W
IP20 • 20022
black/tinted colour



5 996595 722111

7221B **MG**

☒ E27 / 3x max. 40W
IP20 • 20022
black/tinted colour



5 996595 722135



ILMARI



72181 **MG**
 ☒ E27 / 1x max. 15W
 IP20 • 20042
 matte black/tinted colour



72184 **MG**
 ☒ E27 / 4x max. 15W
 IP20 • 20042
 matte black/tinted colour



CAMEO

TEXTILE
CABLE

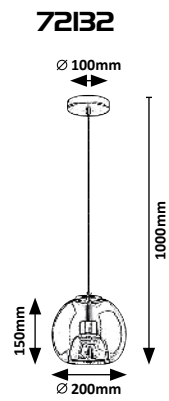
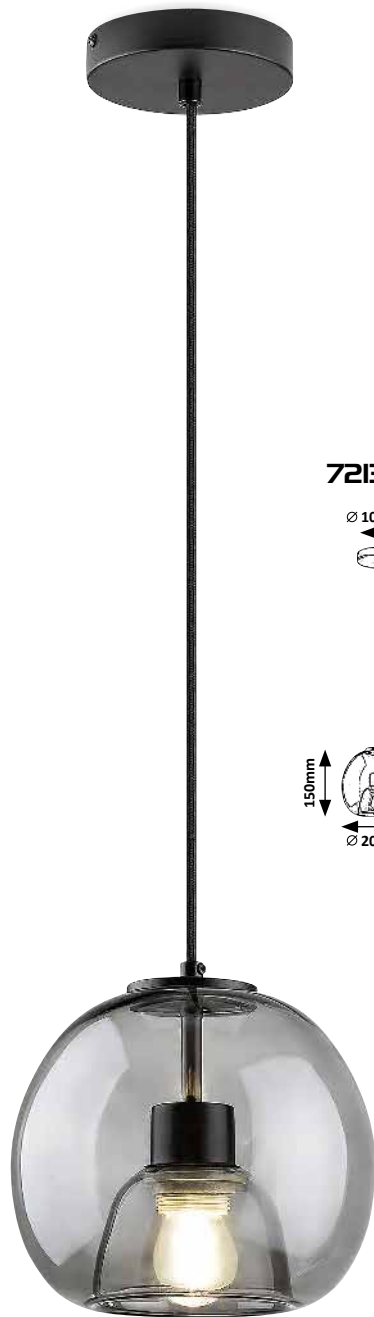

72132 **MG**

☒ E27 / 1x max. 60W
IP20 • 20045
black/tinted colour





CENTIO

TEXTILE
CABLE

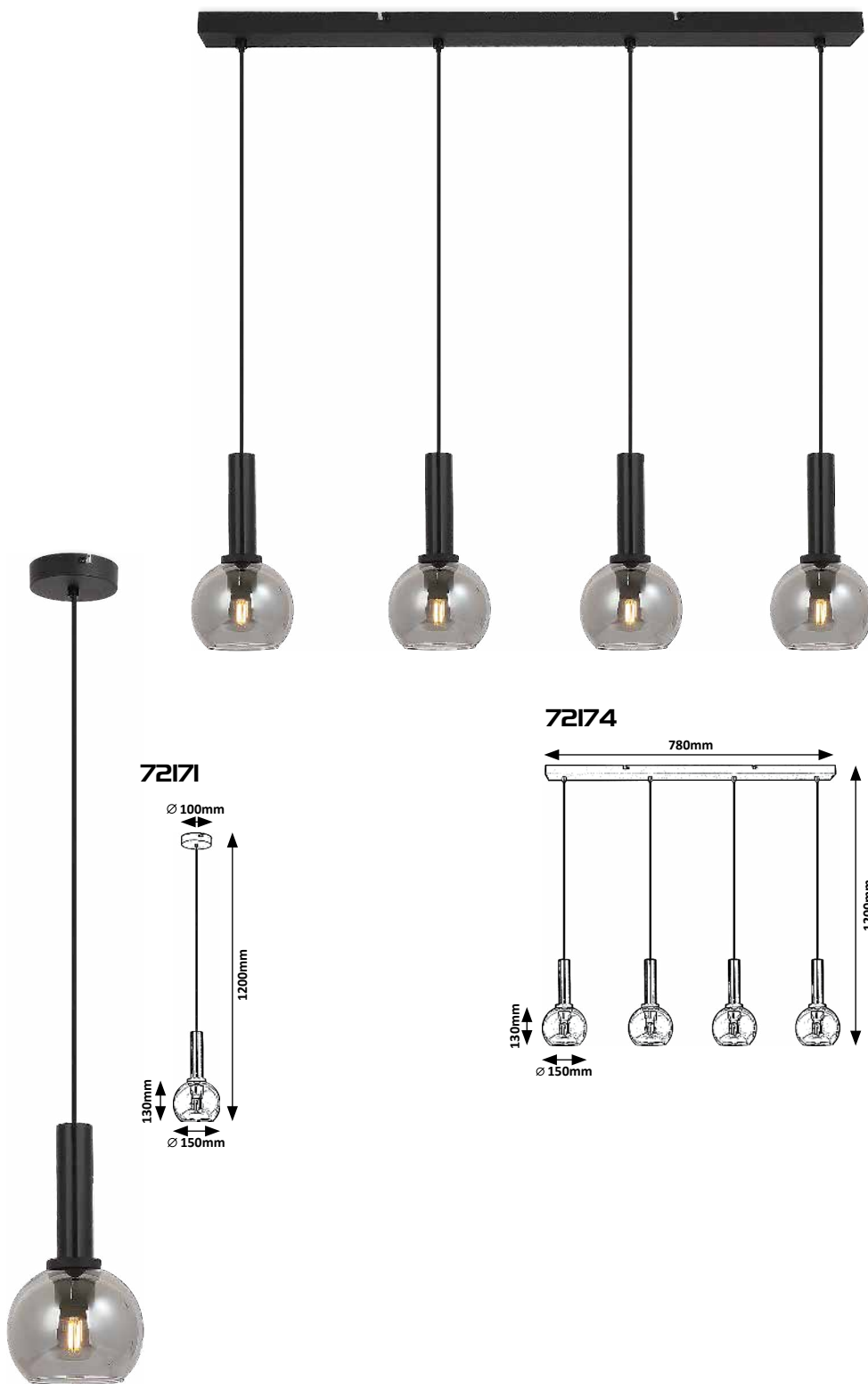

72171 **MG**
 ☒ E27 / 1x max. 40W
 IP20 • 20040
 matte black/tinted colour



5 996595 721718

72174 **MG**
 ☒ E27 / 4x max. 40W
 IP20 • 20040
 matte black/tinted colour



5 996595 721749

RICARDO

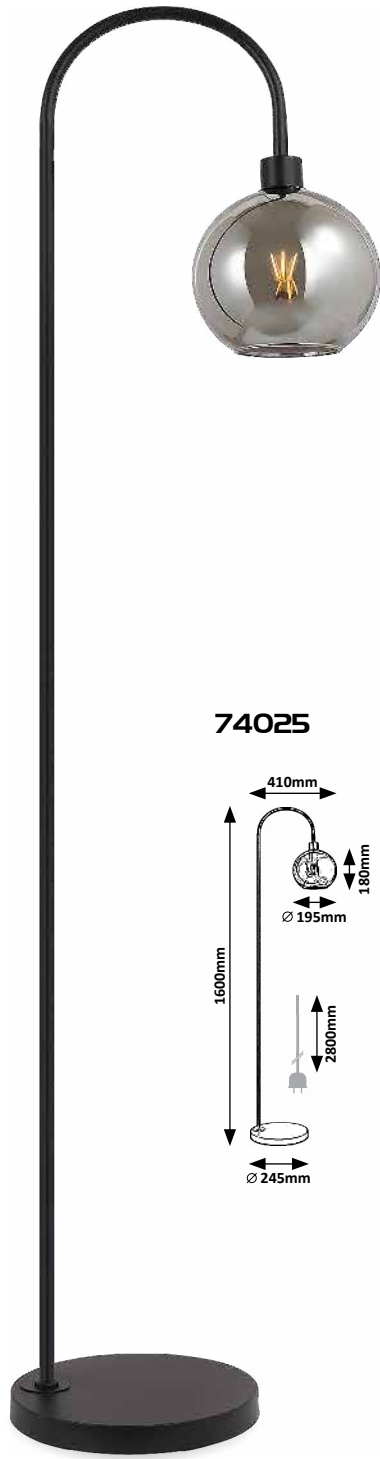

TEXTILE
CABLE

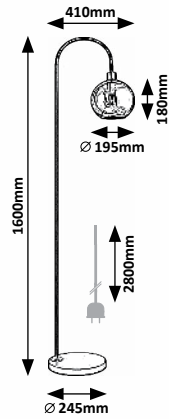

74025



74025 **MG**

☒ E27 / 1x max. 40W
IP20 •  •  20036
matte black/tinted colour



5 996595 740252

VINELLE

TEXTILE
CABLE



74023

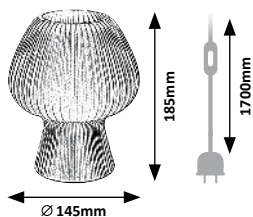

74024

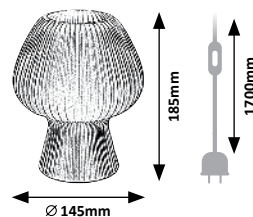

74023



☒ E14 / 1x max. 60W
IP20 • 
white



74024



☒ E14 / 1x max. 60W
IP20 • 
tinted colour



ABRA

TEXTILE
CABLE



72161 **MG**

☒ E27 / 1x max. 60W
IP20 • 20035
matte black/tinted colour



5 996595 721619

72163 **MG**

☒ E27 / 3x max. 60W
IP20 • 20035
matte black/tinted colour



5 996595 721633





KALEVI

TEXTILE
CABLE

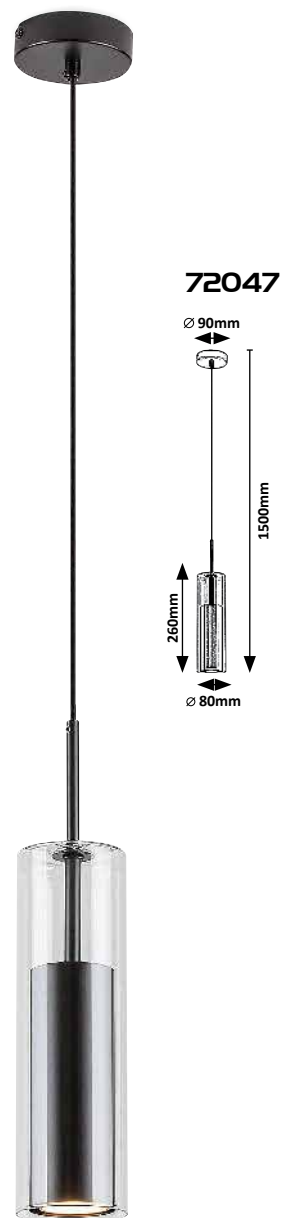
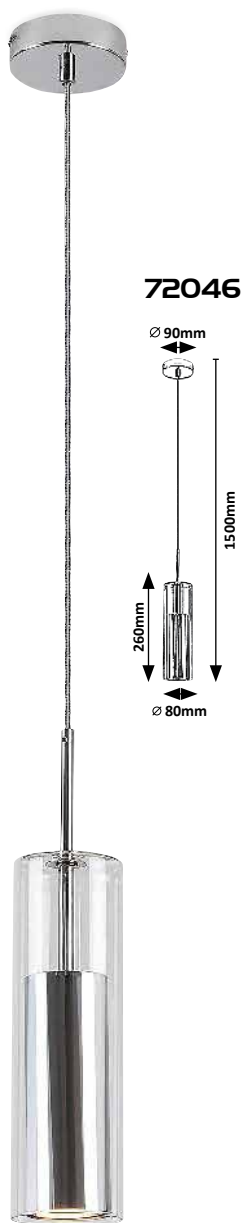

72046 **MG**

☒ GU10 / 1x max. 50W
IP20 • 20038
chrome/transparent



72047 **MG**

☒ GU10 / 1x max. 50W
IP20 • 20038
matte black/transparent



TEXTILE
CABLE

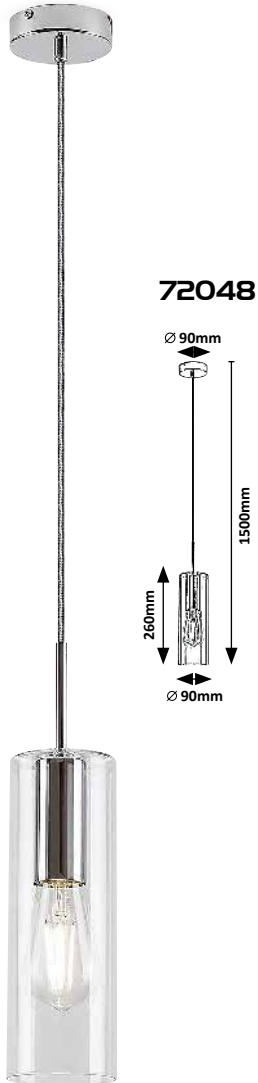

72048

Ø90mm
1500mm
260mm
Ø90mm

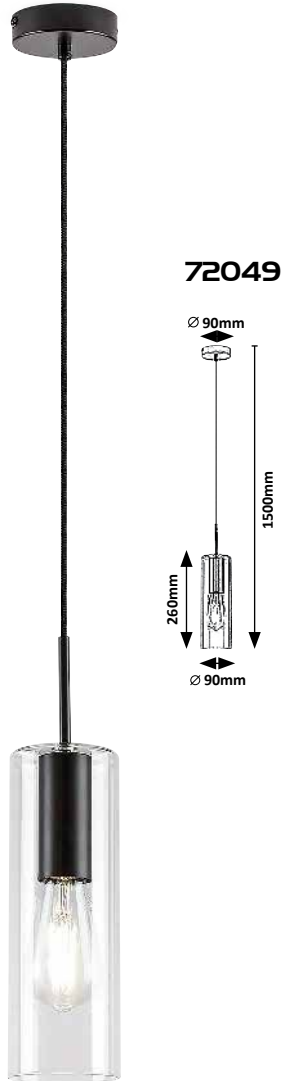

72049

Ø90mm
1500mm
260mm
Ø90mm

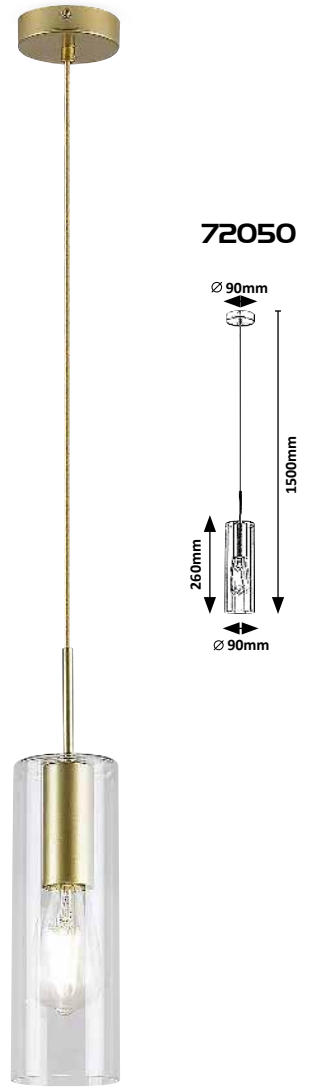

72050

Ø90mm
1500mm
260mm
Ø90mm



72048 **MG**

☒ E27 / 1x max. 40W
IP20 • 20039
chrome/transparent



5 996595 720483

72049 **MG**

☒ E27 / 1x max. 40W
IP20 • 20039
matte black/transparent



5 996595 720490

72050 **MG**

☒ E27 / 1x max. 40W
IP20 • 20039
gold/transparent



5 996595 720506

TEXTILE
CABLE



72201

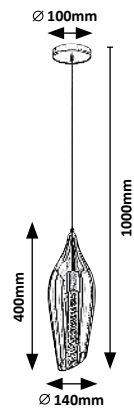

72203

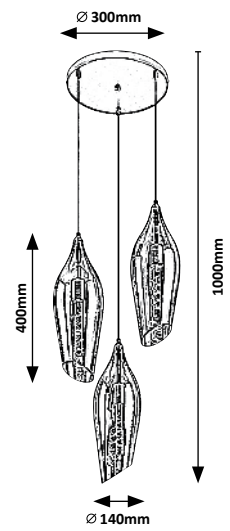

72201 **MG**

E27 / 1x max. 60W
 IP20 • 20044
 black/amber



72203 **MG**

E27 / 3x max. 60W
 IP20 • 20044
 black/amber



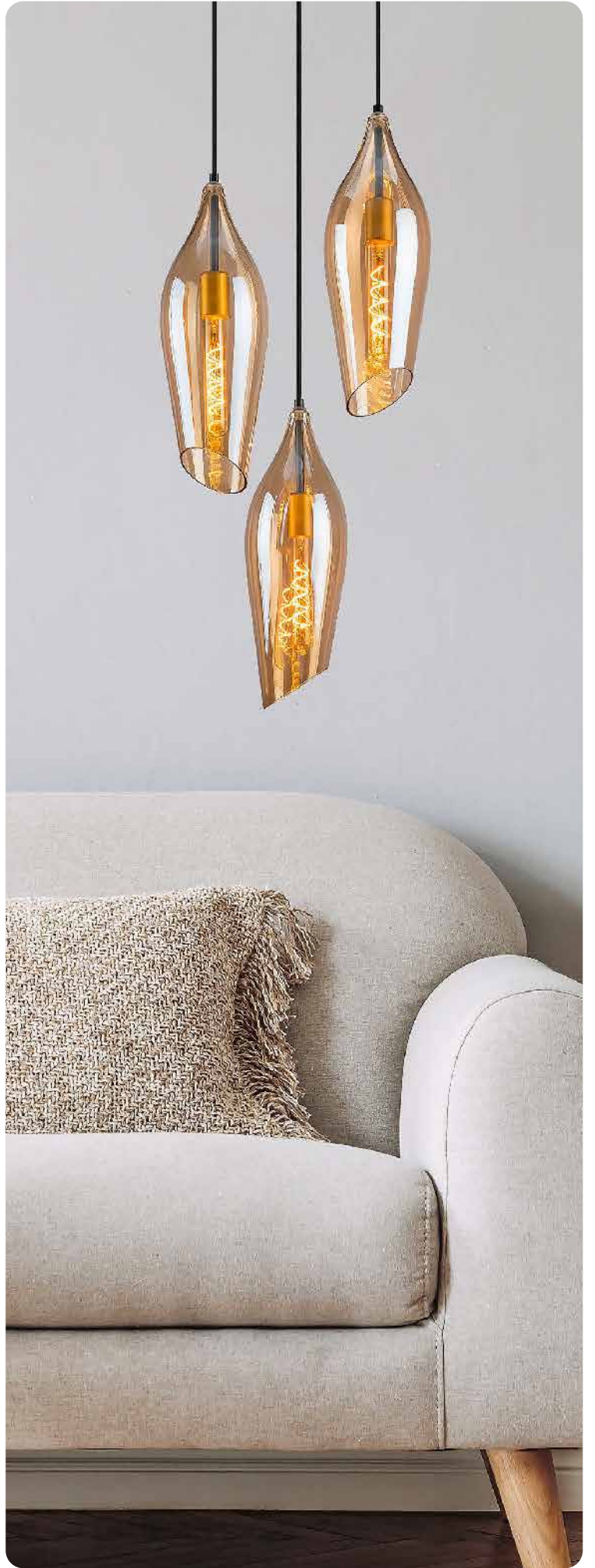

GHITA



71B9



74029

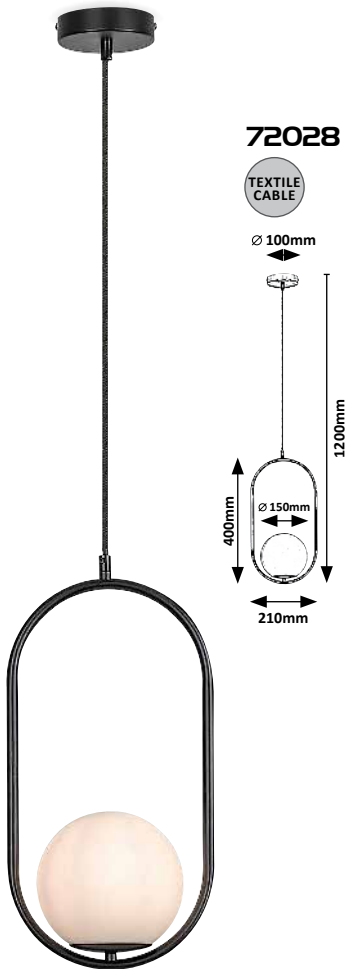

72028



72029

71B9 **MG**

☒ E27 / 1x max. 20W
IP20 • 20024
black/white



72028 **MG**

☒ E27 / 1x max. 20W
IP20 • 20024
black/white



72029 **MG**

☒ E27 / 2x max. 20W
IP20 • 20024
black/white



74029 **MG**

☒ E27 / 1x max. 20W
IP20 • 20024
black/white



SARABI

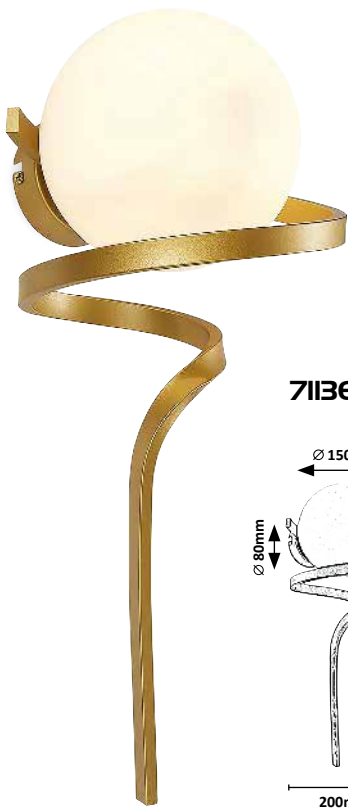

71136

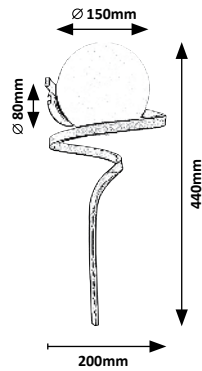

72126

TEXTILE
CABLE

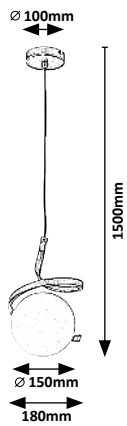

71136 **MG**

☒ E27 / 1x max. 20W
IP20 • 20026
gold/white



5 996595 711368

72126 **MG**

☒ E27 / 1x max. 20W
IP20 • 20026
gold/white



5 996595 721268





03

LED LIGHTS

LED LÁMPÁK

LED DECKENLEUCHTEN

LUDANO



71032

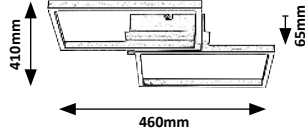

71032 **M P**

LED / 40W
(2400lm, 3700lm;
2700K-6500K) incl. • IP20 • 572
matte black/white



5 996595 710323

71032



ELIA



72127

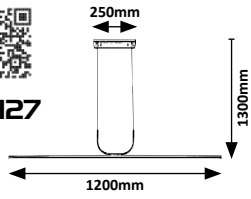

72129

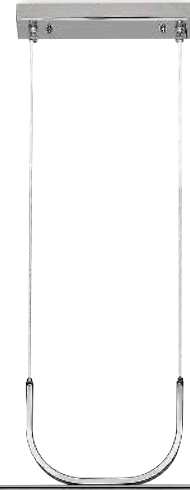
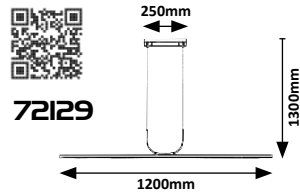

72127



LED / 25W
(1150lm, 2000lm;
3000K) incl. • IP20
matte black/white



5 996595 721275

72129



LED / 25W
(1150lm, 2000lm;
3000K) incl. • IP20
chrome/white



5 996595 721299



TARIQ



72128 
 LED / 30W
( 1650lm,  3000lm;
4000K) incl. • IP20 •  20031
matte black/white

5 996595 721282

CONTESSA



72030

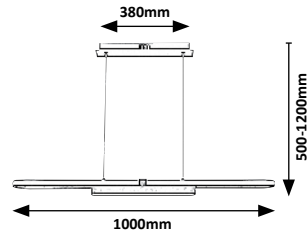

72031

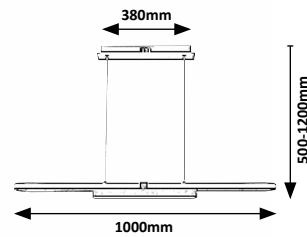

72030 (M) (P)

LED / 48W
(2550lm, 5300lm;
4000K) incl. • IP20 • 20033
black/white



5 996595 720308

72031 (M) (P)

LED / 48W
(2900lm, 5300lm;
4000K) incl. • IP20 • 20033
chrome/white



5 996595 720315

IRELIA

5
YEAR
WARRANTY

LED
built-in

NATURAL
White

G
A
↑
G



71138

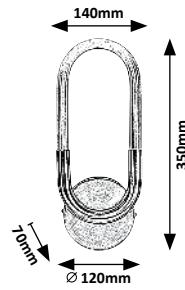

71138 (M) (P)

LED / 9W
(650lm, 1200lm;
4000K) incl. • IP20
satin chrome/white



5 996595 711382



REMIEL



71045

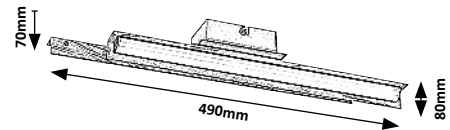

71145

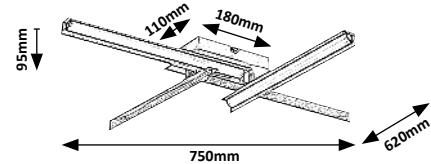

71045 (M) (P)

LED / 12W
(760lm, 1200lm;
3000K) incl. • IP20
matte black/beechn/white



5 996595 710453

71145 (M) (P)

LED / 20W
(1200lm, 1800lm;
3000K) incl. • IP20
matte black/beechn/white



5 996595 711450

REMIEL

5
YEAR
WARRANTY

LED
built-in

WARM
White

G
A
↑
G

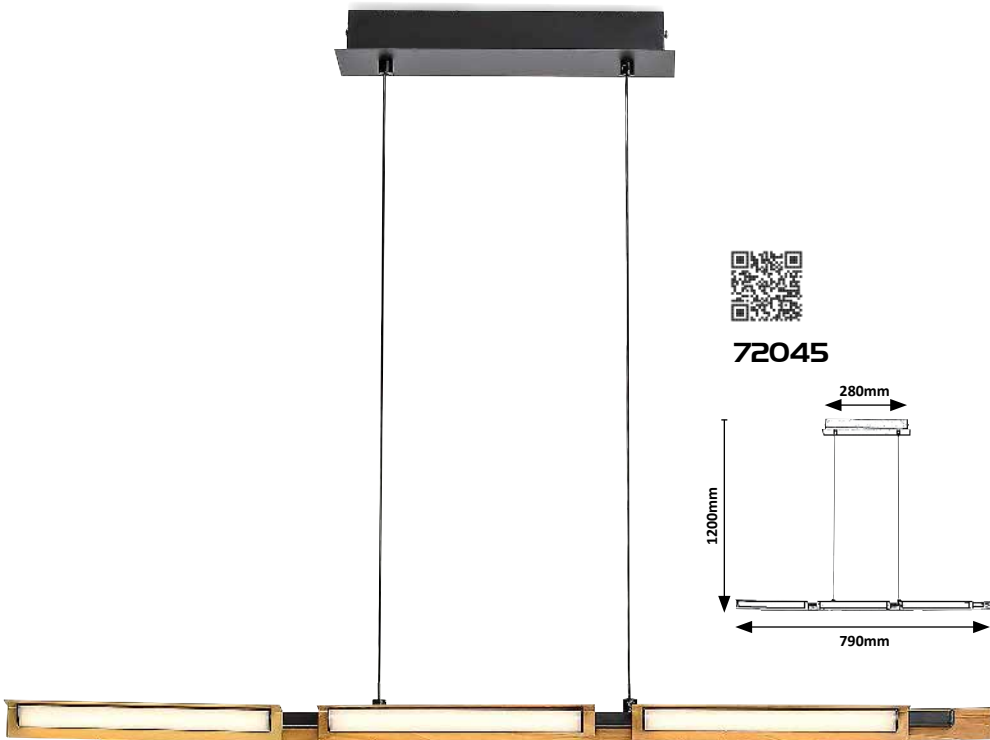

72045 (M) (P)

LED / 30W
(1570lm, 2400lm;
3000K) incl. • IP20
matte black/beech/white



5 996595 720452



04

INDUSTRIAL

INDUSZTRIÁLIS

INDUSTRIAL

SVENS

TEXTILE
CABLE

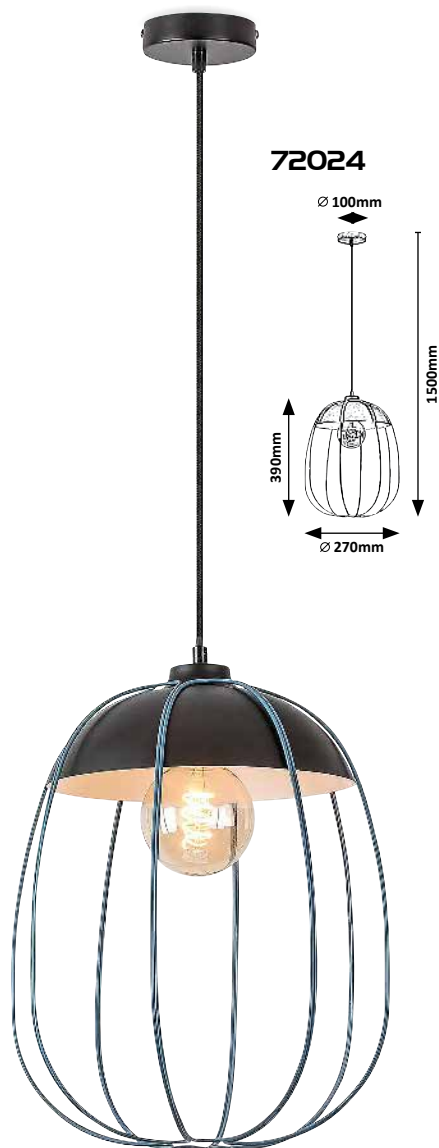

72024 **(M)**
☒ E27 / 1x max. 60W
IP20
matte black/blue



72034 **(M)**
☒ E27 / 1x max. 60W
IP20
matte black/orange





ROXAS

TEXTILE
CABLE

designed by
rabalux



72151 (M)

☒ E27 / 1x max. 40W
IP20
matte black/copper



5 996595 721510

72153 (M)

☒ E27 / 3x max. 40W
IP20
matte black/copper



5 996595 721534

ROXAS

TEXTILE
CABLE

designed by
rabalux



74021

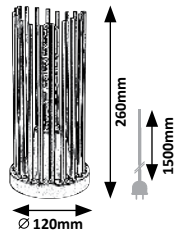

74022

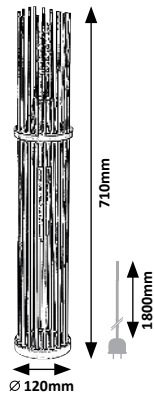

74021 **(M)**

☒ E27 / 1x max. 40W
IP20 • 
matte black/copper



74022 **(M)**

☒ E27 / 2x max. 40W
IP20 • 
matte black/copper



METTA

WOOD

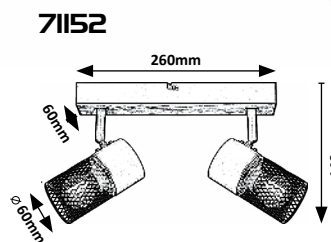
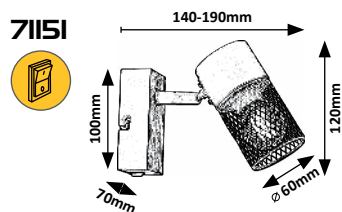

71151 

⊠ E14 / 1x max. 40W
IP20 • 
oak/matte black



71152 

⊠ E14 / 2x max. 40W
IP20
oak/matte black



METTA

WOOD

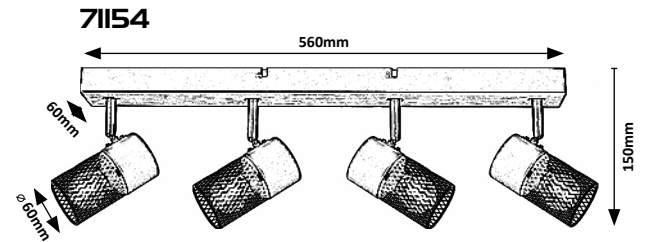
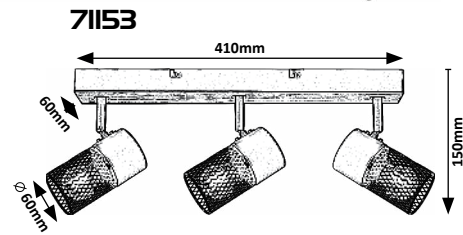

71153 **MW**

☒ E14 / 3x max. 40W
IP20
oak/matte black



71154 **MW**

☒ E14 / 4x max. 40W
IP20
oak/matte black





05

**FLOOR-, TABLE LAMPS,
DECORATIVE LAMPS**

**ÁLLÓ-, ASZTALI
ÉS DEKOR LÁMPÁK**

**STEH-, TISCHLAMPEN
UND DEKORLEUCHTEN**

AMATO



74041

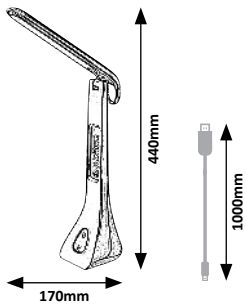

170mm

440mm

1000mm



74042

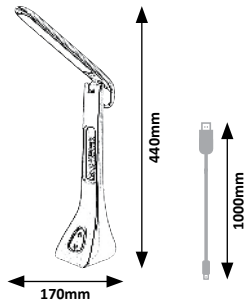

170mm

440mm

1000mm



74041 (P)

DC 5V / LED / 7W
 (340lm, 530lm; 4000K) incl.
 IP20
 black/white



5 996595 740412

74042 (P)

DC 5V / LED / 7W
 (340lm, 530lm; 4000K) incl.
 IP20
 white



5 996595 740429

PARKER



76016

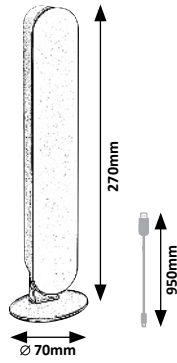

76017

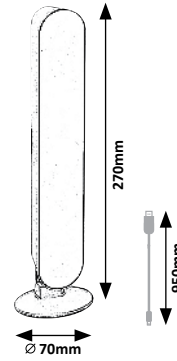

76016



DC 5V / LED / 3W incl.
IP20 • 575
black/white



5 996595 760168

76017



DC 5V / LED / 3W incl.
IP20 • 575
purple/white



5 996595 760175

BARTO

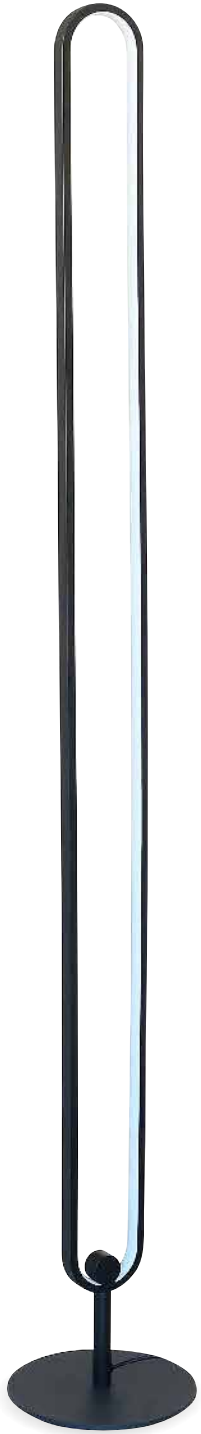

7405I

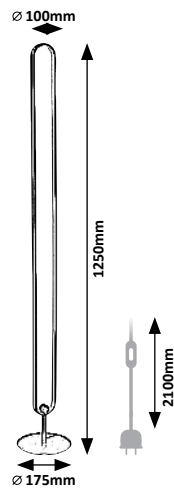

PACO



76014

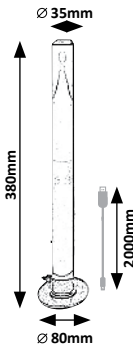

76014



7405I **M P**

DC 12V / LED / 19W incl.
IP20 • 574
matte black/white



5 996595 740511

76014 **P**

DC 5V / LED / 5W incl.
IP20 • 580
black/white



5 996595 760144

76015



SIGGY



76015

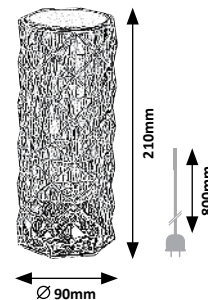

FRANCO



76019

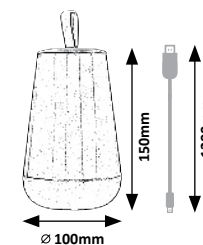

76015 **P**

DC 5V / LED / 1,5W
(45lm) incl.
IP20 • 582
transparent



5 996595 760151

76019 **P**

DC 5V / LED / 2W
(100lm, 120lm; 3000K) incl.
IP20
white



5 996595 760199

RAKAR



78031

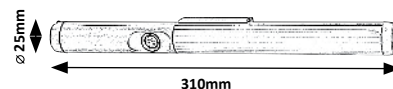

CIRO



76018

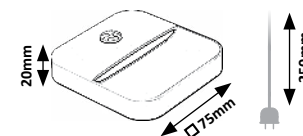

BILAL



78032

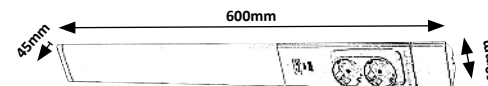

78031 **(P)**

☑ DC 3,7V / LED / 3W
 (☑180lm, ☑200lm; 4000K) incl.
 IP20 • ☑ 2-5m, 100° • ☑
 silver/white



5 996595 780319

76018 **(P)**

☑ DC 5V / LED / 0,15W
 (☑5lm, ☑15lm; 3000K) incl.
 IP20 • ☑ 3-7m, 120° • ☑
 matte white



5 996595 760182

78032 **(M) (P)**

☑ LED / 18W
 (☑1750lm, ☑2350lm;
 4000K) incl. • IP20 • ☑
 matte white



5 996595 780326

KEY OF SYMBOLS • JELMAGYARÁZAT • ZEICHENERKLÄRUNG



GBR



HUN



GER



FRA



CZE



SVK



POL



UKR

	Symbols	Jelölések	Bezeichnungen	Symboles	Jména	Označenia	Oznaczenia	Позначення
	designed by Rabalux	Rábalux saját design	entworfen von Rabalux	conçu par Rabalux	Rabalux vlastní design	Rabalux vlastný dizajn	Zaprojektowano przez Rabalux	розроблений Rabalux
	5 years guarantee	5 év garancia	5 Jahre Garantie	5 ans de garantie	záruka 5 let	Záruka 5 rokov	5-letnia gwarancja	гарантія 5 років
	built-in LED	beépített LED	LED inklusive	LED inclus	obsahuje LED	obsahuje LED diódy	Dioda LED w wyposażeniu	містить світлодіоди
	Smart product	Okos termék	intelligentes Produkt	produit intelligent	chytrý produkt	inteligentný produkt	inteligentny produkt	розумний продукт
	warm white light	meleg fehér fényű	warmweiß	blanc chaud	teplá bílá	teplá biela	ciepła biała	теплий білий
	natural white light	természetes fehér fényű	naturweiß	blanc naturel	přirozená bílá	přírodní biela	naturalna biała	натуральний білий
	colour temperature variable with remote control	távirányítóval állítható színhőmérséklet	Mit fernbedienung einstellbare Farbtemperatur	Température de couleur réglable par télécommande	Nastavení teploty chromatičnosti dálkovým ovládačem	Možnosť nastavenia teploty farieb s diaľkovým ovládačom	Zmienna temperatura barwowa za pomocą pilota	Регулювання колірної температури через пульт дистанційного керування
	colour temperature variable with switch	kapcsolóval állítható színhőmérséklet	mit Schalter einstellbare Farbtemperatur	température de couleur réglable avec interrupteur	spínačem nastavitelná teplota chromatičnosti	možnosť nastavenia teploty farieb spínačom	temperatura barwowa regulowana wyłącznikiem	колірна температура, регульована перемикачем
	Color temperature can be adjusted in 3 steps with remote control	Távirányítóval 3 lépésben szabályozható színhőmérséklet	Die Farbtemperatur kann mit einer Fernbedienung in 3 Stufen eingestellt werden	La température de couleur peut être ajustée en 3 étapes avec une télécommande	Barevnou teplotu lze ovládat ve 3 krocích pomocí dálkového ovládače	Farebnú teplotu je možné nastaviť v 3 krokoch pomocou diaľkového ovládača	Temperaturę barwową można regulować w 3 krokach za pomocą pilota	Колірну температуру можна регулювати в 3 кроки за допомогою пульта дистанційного керування
	Color temperature can be adjusted in 3 steps with a switch	Kapcsolóval 3 lépésben szabályozható színhőmérséklet	Die Farbtemperatur kann mit einem Schalter in 3 Stufen eingestellt werden	La température de couleur peut être ajustée en 3 étapes avec un interrupteur	Teplotu barev lze nastavit pomocí přepínače ve 3 krocích	Farebnú teplotu je možné nastaviť v 3 krokoch pomocou prepínača	Temperaturę barwową można regulować w 3 krokach za pomocą przełącznika	Колірну температуру можна регулювати в 3 кроки за допомогою перемикача
	adjustable brightness in 3 steps with switch	Kapcsolóval 3 lépésben szabályozható fényerő	Einstellbare Helligkeit mit Schalter in 3 Stufen	Luminosité ajustable avec interrupteur à 3 positions	Nastavitelný jas pomocí spínače ve 3 krocích	Nastavitelný jas pomocou spínača v 3 krokoch	Jasność dostosowywana przełącznikiem w 3 krokach	Регульована яскравість з перемикачем в 3 кроки
	with touch switch	érintőkapcsolóval	mit Berührungsschalter	avec interrupteur tactile	dotykový spínač	s dotykovým spínačom	ze ściemniaczem	із сенсорним перемикачем
	touch switch dimmer	érintőkapcsolóval szabályozható fényerő	Touchbutton-Lichtstärkereglер	réglage de la luminosité avec interrupteur tactile	nastavení jasu dotykovým spínačem	dotykový spínač na regulácia intenzity svetla	ściemniacz dotykowy	сенсорний диммер
	light intensity variable only with remote control	csak távirányítóval állítható fényerő	Lichtintensität nur mit Fernbedienung einstellbar	intensité lumineuse variable uniquement avec télécommande	intenzitu světla lze nastavit pouze pomocí dálkového ovládání	možnosť nastavenia intenzity svetla iba s diaľkovým ovládačom	natężenie światła regulowane tylko przy pomocy pilota	інтенсивність світла регулюється тільки за допомогою пульта
	RGB colour change LED	RGB színváltós LED	Farbwechsel-LED	LED à changement de couleurs	LED diody střídající barvu	LED s meniacou sa farbou	Zmieniający kolor LED	Світлодіоди зі зміною кольору
	Magic RGB	Magic RGB	Magic RGB	RVB magique	Kouzelné RGB	Kúzelné RGB	Magia RGB	Чарівний RGB

KEY OF SYMBOLS • JELMAGYARÁZAT • ZEICHENERKLÄRUNG



	Simboluri	Označavanje	Oznake	Oznake	Символи	Simboliai	Simboli	Sümbolid
	designed de Rabalux	Rabalux dizajn	dizajnirao Rablux	zasnoval Rabalux	проектирано от Rabalux	suprojektavo „Rabalux“	izstrādājis Rabalux	Rabaluxi disain
	5 ani garanție	5 godina garancije	5 godina jamstva	5 let garancije	5 години гаранция	5 metų garantija	5 gadu garantija	5-aastane garantii
	LED încorporat	ugrađeni LED	ugrađeni LED	vgrajen LED	вграден LED	įmontuotas LED įrenginys	ieibūvēta LED	sisse-ehitatud LED
	produs inteligent	паметан производ	pametnan proizvod	pameten izdelek	интелигентен продукт	protingas produktas	gudrs produkts	tark toode
	alb cald	toplo bela	toplo bijelo	toplo bela	топло бяло	šiltai balta	silti balts	soe valge
	alb natural	prirodno bela	prirodno bijelo	naravno bela	естествено бяло	natūraliai balta	dabīgi balts	loomulik valge
	Temperatura colorii reglabilă de la telecomandă	Sa daljinskim prekidačem može da se podesi temperatura boja	Pomoću daljinskog prekidača možete podesiti temperaturu boje	Barvno temperaturo lahko nastavite z daljinskim stikalom	Регулиране на цветната температура с дистанционно управление	Kintanti spalvinė temperatūra su nuotoliniu pulteliu	Maināma krāsu temperatūra ar tālvadības pulti	Muutuv värvustemperatuur kaugjuhtimisega
	temperatura colorii controlată cu comutator	temperatura boja može da se podesi sa prekidačem	temperatura boja se može podesiti s prekidačem	barvna temperatura nastavljiva s stikalom	регулируема с ключ светлинна температура	jungikliu keičiama spalvos temperatūra	ar slēdzi maināma krāsu temperatūra	lūlitīga reguleeritav värvitemperatuur
	Temperatura de culoare poate fi reglată în 3 trepte cu ajutorul telecomenzii	Temperatura boje se može podesiti u 3 koraka pomoću daljinskog upravljača	Temperatura boje može se podesiti u 3 koraka daljinskim upravljačem	Barvno temperaturo lahko nastavite v 3 korakih z daljinskim upravljalnikom	Цветовата температура може да се регулира в 3 стъпки с дистанционното управление	Spalvos temperatūrą nuotolinio valdymo pulteliu galima reguliuoti 3 žingsniais	Krāsu temperatūru var regulēt 3 soļos ar tālvadības pulti	Värvitemperatuuri saab kaugjuhtimispuldiga 3-astmeliselt reguleerida
	Temperatura de culoare poate fi reglată în 3 trepte cu un comutator	Температура боје се може подесити у 3 корака помоћу прекидача	Температура боје може се подесити у 3 корака помоћу прекидача	Barvno temperaturo lahko nastavite v 3 korakih s stikalom	Цветовата температура може да се регулира на 3 стъпки с превключател	Spalvos temperatūrą galima reguliuoti 3 žingsniais jungikliu	Krāsu temperatūru var regulēt 3 soļos ar slēdzi	Värvitemperatuuri saab lūlitīga reguleerida 3 astmes
	Luminozitate ajustabilă prin comutator în 3 trepte	Podesivo osvetljenje u 3 koraka uz pomoć prekidača	Prilagodljiva svjetlina s prekidačem u tri koraka	Prilagodljiva svetlost s stikalom v 3 korakih	Регулируема яркост с ключ на 3 степени	Ryškumas reguliuojamas su jungikliu 3 žingsniais	Trīs līmeņu regulējams spilgtums ar slēdzi	Lūlitist 3-astmeliselt reguleeritav heledus
	cu senzor tactil	sa prekidačem na dodir	s dodirnom sklopkom	z stikalom na dotik	със сензорен превключател	liečiamasis jutiklis	skārienjutīgs slēdzis	puuetundlik lūliti
	senzor tactil pentru reglarea luminozității	podešavanje jačine svetlosti sa prekidačem na dodir	podešavanje svjetline pomoću dodirne sklopke	Prilagodite svetlost z stikalom na dotik	регулатор на яркостта със сензорен превключател	liečiamasis priremdymo jutiklis	skārienjutīgs gaismmaīņa slēdzis	puuetundlik valgusregulaator
	Intensitate variabilă a luminii numai de la telecomandă	Intenzitet svetlosti podesiv samo uz pomoć daljinskog upravljača	jačina svjetla promjenjiva samo sa daljinskim upravljačem	možnost nastavitve jakosti svetlobe samo z daljinskim upravljanjem	димирание само чрез дистанционно управление	tik šviesos stiprio kintamasis su nuotoliniu valdymo pultu	gaismas intensitāte mainīga tikai ar tālvadības pulti	valguse intensiivsust saab reguleerida ainult kaugjuhtimispuldi abil
	LED RGB	LED sa promenljivim bojama	LED s promjenljivim bojama	LED diode s spremenljivim barvama	LED с променлива светлина	Spalvą keičiantis LED	Maināmas krāsas LED	Värvi vahetav LED
	RGB Magic	Magic RGB funkcija	Čarobni RGB	Magic RGB	Магическа RGB светлина	Stebuklingas RGB	Maģiskais sarkanžilzais krāsu modelis	Magic RGB

KEY OF SYMBOLS • JELMAGYARÁZAT • ZEICHENERKLÄRUNG



GBR



HUN



GER



FRA



CZE



SVK



POL



UKR

	Symbols	Jelölések	Bezeichnungen	Symboles	Jména	Označenia	Oznaczenia	Позначення
	motion sensor	mozgásérzékelő	Bewegungssensor	détecteur mouvement	senzor pohybu	senzor pohybu	czujnik ruchu	датчик руху
	light reactive, only illuminates in the dark	fényérzékelő lámpa, csak sötétben világít	mit Helligkeitssensor, leuchtet nur im Dunkeln	l'appareil est muni d'un photodétecteur, il ne se manifestera que s'il est plongé dans l'obscurité	se světelným senzorem, svítí pouze ve tmě	so svetelným senzorum, svieti iba v tme	z czujnikiem oświetlenia, świeci tylko w ciemności	оснащений світловим вмикачем, включається тільки при зниженні інтенсивності освітлення
	textile cable	textil kábel	Textilkabel	Câble en tissu	Textilní kabel	Textilný kábel	Kabel tekstylny	Текстильний кабель
	backlight effect	háttérfény funkció	Hintergrundlichteffekt	effet de contre-jour	efekt podsvícení	efekt podsvietenia	efekt podświetlenia	ефект підсвічування
	wood	fa	Holz	bois	dřevo	Drevo	Drewno	дерево
	timer function	időzítő funkció	mit einer Zeitfunktion	avec fonction de temps	s časovačem	s časovačom	z funkcją timera	з функцією таймера
	night light function	éjszakai funkció	Nachtfunktion	fonction nuit	funkce nočního světla	funkcia nočného svetla	Funkcja światła nocnego	функція нічника
	memory function	memória funkció	Speicherfunktion	fonction mémoire	funkce paměť	funkcia pamäte	Funkcja pamięci	функція пам'яті
	alarm clock function	ébresztőóra funkció	Wecker-Funktion	fonction réveil	funkce budíku	funkcia budíka	funkcja budzika	функція будильника
	slimline	keskeny kivitel	schmale Variante	version étroite	tenké provedení	úzke prevedenie	wąska konstrukcja	вузький дизайн
	can be controlled via Bluetooth	vezérlés Bluetooth kapcsolaton keresztül	Steuerung über Bluetooth	commande via liaison Bluetooth	ovládání prostřednictvím Bluetooth kontaktu	riadenie prostredníctvom Bluetooth pripojenia	sterowanie przez połączenie Bluetooth	керування через Bluetooth
	micro-USB included	micro-USB tartozék	Micro-USB Zubehör	Avec Micro USB livré	Micro-USB v příslušenství	Príslušenstvo Micro-USB	Micro-USB w zestawie	Містить мікро-USB
	with USB cable and adaptor	USB vezetékkel és adapterrel	mit USB Kabeln und Adapter	avec câble USB et adaptateur	USB kabel a adaptér	s USB káblom a adaptérom	z kablem USB i adapterem	із USB-кабелем та адаптером
	battery included	elemet tartalmaz	inklusive Batterie	pile incluse	součástí balení je baterie	súčasťou balenia je batéria	Bateria w zestawie	батарея додається
	Equipped with SCHUKO Type F, CEE 7/4 power connector socket. Not available for CZ, SK and PL.	SCHUKO Type F, CEE 7/4 hálózati csatlakozó aljzattal. Nem rendelhető: CZ, SK és PL.	Mit SCHUKO Netzstecker Typ F, CEE 7/4. Nicht bestellbar in: CZ, SK und PL	SCHUKO Type F, avec douille CEE 7/4. Ne peut être commandé : CZ, SK et PL	SCHUKO Type F, CEE 7/4 se síťovou zásuvkou. Nelze objednat: CZ, SK a PL	SCHUKO Type F, CEE 7/4 so sieťovou zásuvkou. Nie je možné objednať: CZ, SK a PL	Z gniazdem zasilania SCHUKO Type F, CEE 7/4. Brak możliwości zamawiania: CZ, SK i PL	SCHUKO Type F, з гніздом живлення CEE 7/4. Неможливо замовляти: CZ, SK та PL

KEY OF SYMBOLS • JELMAGYARÁZAT • ZEICHENERKLÄRUNG



	Simboluri	Označavanje	Oznake	Oznake	Символи	Simboliai	Simboli	Sümbolid
	senzor de mișcare	senzor kretanja	senzor kretanja	senzor gibanja	със сензор за движение	judesio jutiklis	kustības sensors	liikumisandur
	cu sensor, luminează doar în întineric	osetljiv na svetlost, svetli samo u mraku	osjetljiv na svjetlost, svijetli samo u mraku	občutljivo na svetlobo, sveti le v temi	реагира на светлина, светва само, когато е тъмно	reaguoja į šviesą, užsidega tik tamsoje	reaģējošs uz gaismu, apgaismo tikai tumsā	valgusreaktiivne, valgustab vaid pimedas
	Cablu cu teacă textilă	Tekstilni kabl	Tekstilni kabel	Tekstilni kabel	Текстилен кабел	Tekstile vilktas laidas	Vads ar tekstilmateriālu pārklājumu	Tekstiilkaabel
	efect iluminare de fundal	pozadinsko osvetljenje	efekt pozadinskog svjetla	učinek osvetlitve	ефект на подсветка	foninio apšvietimo efektas	aizmugurapgaismojuma efekts	tagantvalgustuse efekt
	lemn	drven	drvo	les	дърво	medis	koksne	puit
	cu temporizator	sa vremenskom funkcijom	s vremenskom funkcijom	s časovno funkcijo	с функция за време	su laiko funkcija	ar laika funkciju	ajafunktsiooniga
	Funcție lumina de noapte	funkcija nočno svetlo	funkcija nočnog svjetla	nočna funkcija	функция нощна светлина	naktinio apšvietimo funkcija	nakts apgaismojuma funkcija	ööine funktsioon
	Funcție de memorie	funkcija pamćenja	funkcija memorije	pomnilna funkcija	функция памет	atminties funkcija	atmiņas funkcija	mälu funktsioon
	funcție ceas deșteptător	funkcija budilice	funkcija budilice	funkcija budilke	функция на будилника	žadintuvo funkcija	modinātāja funkcija	äratuskella funktsioon
	Design îngust	uska izvedba	uska izvedba	ozka izvedba	тясно изпълнение	mažų matmenų	plāns	õhuke profiil
	operare prin conexiune Bluetooth	upravljanje preko Bluetooth veze	upravljanje putem Bluetootha	nadzor prek povezave Bluetooth	управление чрез Bluetooth връзка	Galima valdyti naudojant Bluetooth	Var kontrolēt, izmantojot Bluetooth	Juhitav Bluetooth kaudu
	Accesoriu Micro-USB	Mikro-USB dodatna oprema	Mikro USB pribor	Mikro USB-pripomoček	С принадлежност Micro-USB	Pridedama „Micro-USB“	Micro-USB iekļauts komplektā	Mikro-USB komplektis
	Cablu USB și adaptor	sa USB priključkom i adapterom	s USB priključkom i adapterom	z USB priključkom in adapterjem	с USB кабел и адаптер	su USB kabeliu ir adapteriu	ar USB kabeli un adapteri	USB-kaabli ja adapteriga
	bateria este inclusă	baterija u opremi	baterija je uključena	baterije so vključene	предоставена батерия	su baterija	baterija ietilpst komplektā	patarei kuulub komplekti
	Cu soclu priză SCHUKO Type F, CEE 7/4. Nu poate fi comandat în CZ, SK și PL	Sa mrežnom priključnicom tipa SCHUKO Type F, CEE 7/4 Ne može da se naruči iz: CZ, SK i PL	S mrežnim priključkom tipa SCHUKO Type F, CEE 7/4 Nije moguće naručiti iz: CZ, SK i PL	Z vtičem tipa SCHUKO Type F, CEE 7/4 Ni mogoče naročiti pri: CZ, SK in PL	SCHUKO Type F, захранващо щепселно гнездо CEE 7/4. Не може да се заявява за: CZ, SK и PL	Įmontuotas SCHUKO F tipo CEE 7/4 maitinimo įvesties lizdas. Neprieinama CZ, SK ir PL	Aprīkots ar SCHUKO F tipa, CEE 7/4 strāvas ievades/izvades ligzdu. Nav pieejams CZ, SK un PL	SCHUKO Tüüp F, CEE 7/4 toite sisse/välja pistikuga. Mitte saadaval CZ, SK ja PL jaoks

COLOURS • SZÍNEK • FARBEN



amber	borostyán	Bernstein	ambre	jantar	jantár	bursztynowy	бурштиновий
beech	bükk	Buche	hêtre	buk	buk	buk	бук
black	fekete	Schwarz	noir	černá	čierna	czarny	чорний
blue	kék	Blau	bleu	modrá	modrá	niebieski	синій
brown	barna	Braun	brun	Hnědá	hnedá	Brazowy	коричневий
chrome	króm	Chrome	chrome	chromová	chrómová	chrom	хромовий
copper	réz	Kupfer	civre	měděná	medená	miedz	мідь
gold	arany	Gold	dorée	zlatá	zlatá	złoty	золотий
grey	szürke	Grau	gris	šedá	šedá	popielaty	сірий
matte black	matt fekete	Mattschwarz	noir mat	matná černá	matná čierna	czarny matowy	матово-чорний
matte white	matt fehér	Mattweiss	blanc mat	matná bílá	matná biela	biały matowy	матово-білий
oak	tölgy	Eiche	chêne	dub	dub	dąb	дуб
orange	narancs	Orange	orange	oranžová	oranžová	pomarańczowy	помаранчевий
purple	lila	Lila	lilas	fialová	fialová	fioletowy	ліловий
satin chrome	szatin króm	Satin-Chromfarbig	chrome satiné	hedvábně lesklá chromová	saténová chrómová	chrom satyna	сатиново хромовий
silver	ezüst	Silber	argent	stříbrná	strieborná	srebrny	срібний
tinted colour	füst színű	Rauchfarbig	fumée	dýmová barva	dymová	przydymiony	димчастий
transparent	átlátszó	transparent	transparent	průhledná	priehľadná	przezroczysty	прозорий
white	fehér	Weiss	blanc	bílá	biela	biały	білий

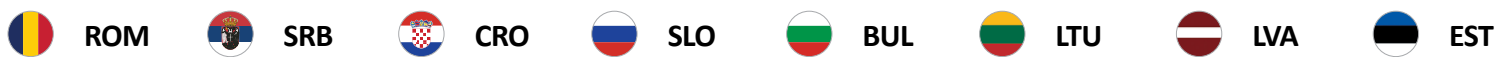

galben de hihlimbar	bršljan	bršljan	bršljan	кехлибарено	gintaras	dzintars	merevaigukollane
fag	bukva	bukva	bukev	бук	buko	dižskābardis	pöök
negru	crno	crno	črno	черен	juoda	melns	must
albastru	plavo	plavo	modro	син	mėlyna	zils	sinine
maro	smeđa	braun	rjavo	кафяв	ruda	brūns	pruun
crom	hrom	krom	krom	хром	chrominė	hroms	kroom
cupru	bakren	bakren	baker	медна	vario	varš	vask
auriu	zlatno	zlatno	zlato	златен	auksinė	zelta	kuldne
gri	sivo	sivo	sivo	сив	pilka	pelēks	hall
mat negru	mat crno	mat crno	mat črno	мат-черен	matinė juoda	matēti melns	matt must
mat alb	mat belo	mat bijelo	medlobel	мат-бял	matinė balta	matēti balts	matt valge
stejar	hrast	hrast	hrast	дъб	ąžuolo	ozols	tamm
portocaliu	narandžasto	narandža	oranžno	оранжев	oranžinė	oranžs	oranž
violet	ljubičasto	ljubičasto	vijoličasto	лилав	violetinė	violets	lilla
crom satin	saténasti hrom	saténasti krom	saténast krom	сатенен-хром	atlaso chrominė	satīna hroms	satiin-kroom
argintiu	srebrno	srebrno	srebrno	сребърен	sidabrinė	sudraba	hõbe
fumuriu	boje dima	indigo plava	barva dima	прозиращо кафяво	su atspalviu	tonēta krāsa	toonitud värv
transparent	providan	proziran	prozorno	прозрачен	skaidri	caurspīdīgs	läbipaistev
alb	belo	bijelo	belo	бял	balta	balts	valge

CONTENTS • TARTALOMJEGYZÉK • INHALTSVERZEICHNIS

Art. number	Name	Page
Cikkszám	Név	Oldal
Art. nummer	Name	Seite

Art. number	Name	Page
Cikkszám	Név	Oldal
Art. nummer	Name	Seite

Art. number	Name	Page
Cikkszám	Név	Oldal
Art. nummer	Name	Seite

Art. number	Name	Page
Cikkszám	Név	Oldal
Art. nummer	Name	Seite

71044	Leola	4
71146	Arild	4
71141	Gandor	5
71029	Liatris	5
71159	Fontana	6
71046	Dettora	7
71140	Nilin	8
71142	Konte	9
71155	Ezio	10
71156	Ezio	10
71157	Ezio	10
71158	Ezio	10
71147	Nabil	11
71148	Nabil	11
72211	Salvatore	13
72213	Salvatore	13
72181	Ilmari	14
72184	Ilmari	14

72132	Cameo	15
72171	Centio	16
72174	Centio	16
74025	Ricardo	17
74023	Vinelle	18
74024	Vinelle	18
72161	Abra	19
72163	Abra	19
72046	Kalevi	20
72047	Kalevi	20
72048	Esta	21
72049	Esta	21
72050	Esta	21
72201	Bellini	22
72203	Bellini	22
71139	Ghita	24
72028	Ghita	24
72029	Ghita	24

74029	Ghita	24
71136	Sarabi	25
72126	Sarabi	25
71032	Ludano	27
72127	Elia	28
72129	Elia	28
72128	Tariq	29
72030	Contessa	30
72031	Contessa	30
71138	Irelia	31
71045	Remiel	32
71145	Remiel	32
72045	Remiel	33
72024	Svens	35
72034	Svens	35
72151	Roxas	36
72153	Roxas	36
74021	Roxas	37

74022	Roxas	37
71151	Metta	38
71152	Metta	38
71153	Metta	39
71154	Metta	39
74041	Amato	41
74042	Amato	41
76016	Parker	42
76017	Parker	42
74051	Barto	43
76014	Paco	43
76015	Siggy	44
76019	Franco	44
78031	Rakar	45
76018	Ciro	45
78032	Bilal	45

IMPRINT • IMPRESSZUM • IMPRESSUM

English

Colour and pattern discrepancy are possible. We are entitled to change the pattern.
We don't bear the responsibility of the printing failure.

Magyar

Szín és minta eltérés lehetséges. A minta változtatás jogát fenntartjuk!
Az esetleges nyomdai hibákért elnézésüket kérjük és azokért felelősséget nem vállalunk.

Deutsch

Farbe und Musterunterschied ist möglich. Wir halten das Recht von Musteränderung aufrecht.
Vor die eventuellen Druckfehler bitten wir um Entschuldigung und vor die Fehler können wir die Verantwortung nicht übernehmen.

Grafikai munkák: Visionext Reklámstúdió
Nyomdai munkák: VAREG HUNGARY KERESKEDELMI ÉS SZOLGÁLTATÓ KFT.

CONTACT • ELÉRHETŐSÉGEINK • KONTAKT

CENTRE/KÖZPONT/ZENTRALE



Magyarország/Hungary

RÁBALUX HEAD OFFICE
RÁBALUX VILÁGÍTÁSTECHNIKA ZRT.
VILÁGÍTÁSTECHNIKA GYÁRTÁS ÉS FORGALMAZÁS/
LIGHTING PRODUCTION AND DISTRIBUTION

9027 Győr, Körtefa u. 5.
Tel.: +36 96 526 716
E-mail: info@rabalux.com
www.rabalux.com

AFFILIATES/LEÁNYVÁLLALATOK/ZWEIGSTELLEN



Bulgaria

РАБАЛУКС ЕООД / RABALUX EOOD
ул. "Андрей Николов" №15,
1111 София,
България
Тел/Факс: +359 2 936 00 97
E-mail: infobg@rabalux.com
www.rabalux.bg



Croatia

RABALUX RASVJETA d.o.o.
Ulica grada Gospića 1a
10000 Zagreb
Tel.: +385 1 652 80 66
E-mail: infocro@rabalux.com
www.rabalux.hr



Czech Republic

RABALUX CZ Svítidla s.r.o.
Kaštanová 141/a, 617 00 Brno,
Česká Republika
Tel.: +420 739 665 322
E-mail: infocz@rabalux.com
www.rabalux.cz



Hungary

Rabalux Magyarország Kft.
Magyarország
9027 Győr,
Körtefa u. 5.
Tel.: +36 96 526 716
E-mail: infohu@rabalux.com
www.rabalux.hu



Lithuania, Latvia, Estonia

UAB „Rabalux Baltic“
Bičiulių g. 29,
LT-14182 Bukiškis,
Vilniaus r. Lietuva
Tel.: +370 6161 3066
E-mail: infobaltic@rabalux.com
www.rabalux.lt



Poland

Rabalux Sp. z o.o.
ul. Sołtysia 119, 40-750 Katowice,
Polska
Tel.: +48 32 254 61 34
E-mail: infopl@rabalux.com
zamowienia@rabalux.com
www.rabalux.pl



Romania

SC RABALUX SRL
Cluj-Napoca, str. Fabricii,
nr. 93-103, jud. CLUJ
Romania
cod postal: 400632
Tel.: +40 264 456 040
E-mail: inforo@rabalux.com
www.rabalux.ro



Serbia

Rabalux SRB d.o.o.
Autoput br.20
11080 Beograd –
Zemun, Srbija
Mob: + 381 60 444 3977;
Tel.: +381(0)11 2013 986
E-mail: infosrb@rabalux.com
www.rabalux.rs



Slovakia

RABALUX SK. Svietidla, s.r.o.
Alžbetínske nám. 328,
929 01 Dunajská Streda,
Slovenská Republika
Tel.: +421 31 551 54 04
E-mail: infosk@rabalux.com
www.rabalux.sk



Ukraine

ТОВ Рабалукс,
вул. Рилєєва 4, м. Ужгород,
Україна, 88017
тел.: +38 0312 64 04 00,
моб.тел.: +38 067 310 05 20
E-mail: infoua@rabalux.com
www.rabalux.ua

OFFICIAL RESELLERS/MEGBÍZOTT VISZONTELADÓK/BEAUFTRAGTE WIEDERVERKÄUFER



Germany

Jens Stolte Leuchten
GmbH & Co.KG
Am Rischfeld 36
39164 Wanzleben - Börde
Tel.: +49 (0) 39204 915080
E-mail: info@ostfale.com
www.rabalux.de



Slovenia

Lagea d.o.o.
Brezina 19c
8250 Brežice
Republika Slovenija
Tel.: +386 70 292 70 20
E-mail: elmatis@lagea.si



Greece

ANASTASIADI SA
1km Katerini-Ganohora Road,
Katerini, 60100
Tel.: +30 2351039757
E-mail: eshop@anastasiadi.gr
B2C SITE: www.anastasiadi.gr
B2B SITE: www.anastasiadib2b.gr



Greece

S.MELISSOURGOS CO OE
8 Kourtiou St,
11146 Galatsi,
Tel.: +0030 2102136040
E-mail: info@melissourgos.com.gr
melissourgos.com.gr



Portugal

STORM LIGHT,LDA
Rua António Pereira Vidal Xavier nº9,
3750-802 Valongo do Vouga,
Tel.: 234 661 068
E-mail: geral@storm-light.pt
www.storm-light.pt



Spain

Buyled Led Lighting S.L
03007, Alicante,
ES, C/Gillen de Castro 1
Tel.: +34 654 870 866
E-mail: info@buyled.es
www.buyled.es



Italy

Fra.Co.Distribuzione Srl
Sp1 km24,
90047 Partinico (PA)
Tel.: 0039 0915071547
E-mail: info@fracodistribuzione.it
www.fracodistribuzione.it



Finland

Focus Interiors Oy
Kuusipolku 35,
37150 Nokia
Tel.: +358 (0)10 3270 520
E-mail: info@focusinteriors.fi
www.focusinteriors.fi



Qatar

GO GREEN INTERNATIONAL
TRADING W.L.L
New Salata, C Ring Road,
Sharq Capital Building-311 P.O Box 37372,
Doha, Qatar
Tel.: (+974) 4409 5443, (+974) 5552 9088
E-mail: sales@ggilighting.com
www.ggilighting.com



United Kingdom

Lighting Direct
24-26 Vincent Ave,
Crownhill, Milton Keynes
Buckinghamshire, MK8 0AB
E-mail: customerservice@lighting-direct.co.uk
www.lighting-direct.co.uk