

JANUARY
2023
UPDATE

SLAMP®
THE LEADING LIGHT

COMPENDIUM 2022

PRICE LIST - LISTINO PREZZI

ACCORDÉON	8	KALATOS	63
ARIA	10	LA BELLE ÉTOILE	64
ATLANTE	12	LA LOLLO	66
ATMOSFERA	14	LA LOLLONA	66
AURORA	13	LA TRAVIATA	70
AVIA	16	LA VIE	74
AVIA EDITION	17	LAFLEUR	72
BACH	18	LAS PALMAS	71
BIOS	20	LILLIBET	76
CACTUS	23	LIZA	77
CEREMONY	26	LUIS	78
CHANTAL	28	MEDUSA	79
CHARLOTTE	29	MIDA	80
CLIZIA	32	MOON	82
CORDOBA	38	NUVEM	86
DAFNE	40	ODEON	84
DIAMOND	42	OVERLAY	85
DRUSA	44	SUPERMORGANA	89
ECSTACITY	45	THE LIGHTNING ARCHIVES	92
ÉTOILE	65	TULIP	90
FABULA	46	VELI	94
FIGURELLA	48	VENTI	106
FLORA	50	WOODY	93
GEMMY	52		
GINETTA	54		
GOCCIA	55		
HALF CHARLOTTE	30		
HANAMI	56		
HUGO	58		
HUGO ARCHITECTURAL	60		
IDEA	62		

SUSPENSION LAMP INDEX



ACCORDÉON
p.8



ACCORDÉON VERTICAL
p.8



ARIA BLACK FADE
p.10

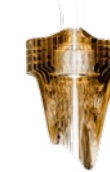

ARIA GOLD
p.10



ARIA TRANSPARENT
p.10



ATLANTE
p.12



ATMOSFERA
p.14



AVIA
p.16



AVIA EDITION
p.17



CACTUS
p.24



CEREMONY
p.26



CHANTAL
p.28



CHARLOTTE GLOBE
p.30

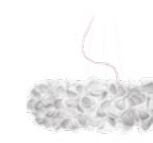

CLIZIA
p.34



CORDOBA
p.38



DRUSA
p.44



ÉTOILE
p.65



FABULA
p.46



FIGURELLA
p.48



FLORA
p.50



GEMMY
p.52



GINETTA
p.54



GOCCIA
p.55



HANAMI
p.56



HALF-CHARLOTTE
p.30

SUSPENSION LAMP INDEX



HUGO
p.58



HUGO ARCHITECTURAL
p.60



HUGO VERTICAL
p.58



KALATOS
p.63



LA BELLE ÉTOILE
p.64



LA LOLLO
p.66



LA LOLLONA
p.66



LA TRAVIATA
p.70



LILLIBET
p.76



LIZA
p.77



LUIS
p.78



MEDUSA
p.79

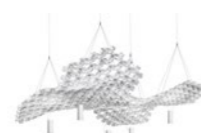

NUVEM
p.86



SUPERMORGANA
p.89



TULIP
p.90



VELI
p.100



VELI FOLIAGE
p.96



VELI MINI
p.102



VELI 7
p.104



WOODY
p.93

CEILING LAMP INDEX



AURORA
p.13



BIOS
p.21



CLIZIA
p.32



DAFNE
p.41



DRUSA
p.44



ÉTOILE
p.65



FABULA
p.47



HANAMI
p.57



KALATOS
p.63



LA BELLE ÉTOILE
p.64



LA VIE
p.74



MIDA
p.80



ODEON
p.84



VELI
p.98



VELI FOLIAGE
p.94



VENTI
p.107

TABLE LAMP INDEX



ACCORDÉON
p.9



ACCORDÉON BATTERY
p.9



ATMOSFERA
p.14



BACH
p.18



BIOS
p.20



CACTUS
p.23



CLIZIA BATTERY
p.36



CLIZIA
p.36



DAFNE
p.40



DIAMOND
p.42



FIORELLINA
p.49



GEMMY
p.52



IDEA
p.62



LAFLEUR
p.72



LAS PALMAS
p.71



LIZA
p.77



MOON
p.82



OVERLAY
p.85



VELI
p.105



VELI FOLIAGE
p.97



VENTI
p.106

WALL LAMP INDEX



ARIA
p.11



BIOS
p.21



CHARLOTTE
p.31



CLIZIA
p.32



CLIZIA APPLIQUE
p.33



DAFNE
p.41



DRUSA
p.44



ÉTOILE
p.65



FABULA
p.47



FIORELLA MINI
p.48



HANAMI
p.57



IDEA
p.62



LA BELLE ÉTOILE
p.64



LA FLEUR
p.73



LA LOLLO
p.68



LA VIE
p.74



LILLIBET MINI
p.76



MEDUSA
p.79



MIDA
p.80



MIDA APPLIQUE
p.80

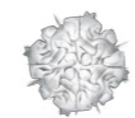

VELI
p.98



VELI FOLIAGE
p.94



VENTI
p.107

TABLE LAMP

WALL LAMP

FLOOR LAMP INDEX



ATLANTE
p.12



BACH
p.18



BIOS
p.20



CACTUS
p.23



CHARLOTTE
p.29



DAFNE
p.40



DIAMOND
p.42



ECSTACITY
p.45



FLORA
p.51



HUGO
p.59



LA LOLLO
p.69



LAS PALMAS
p.71



THE LIGHTNING ARCHIVES
p.92



VENTI
p.106

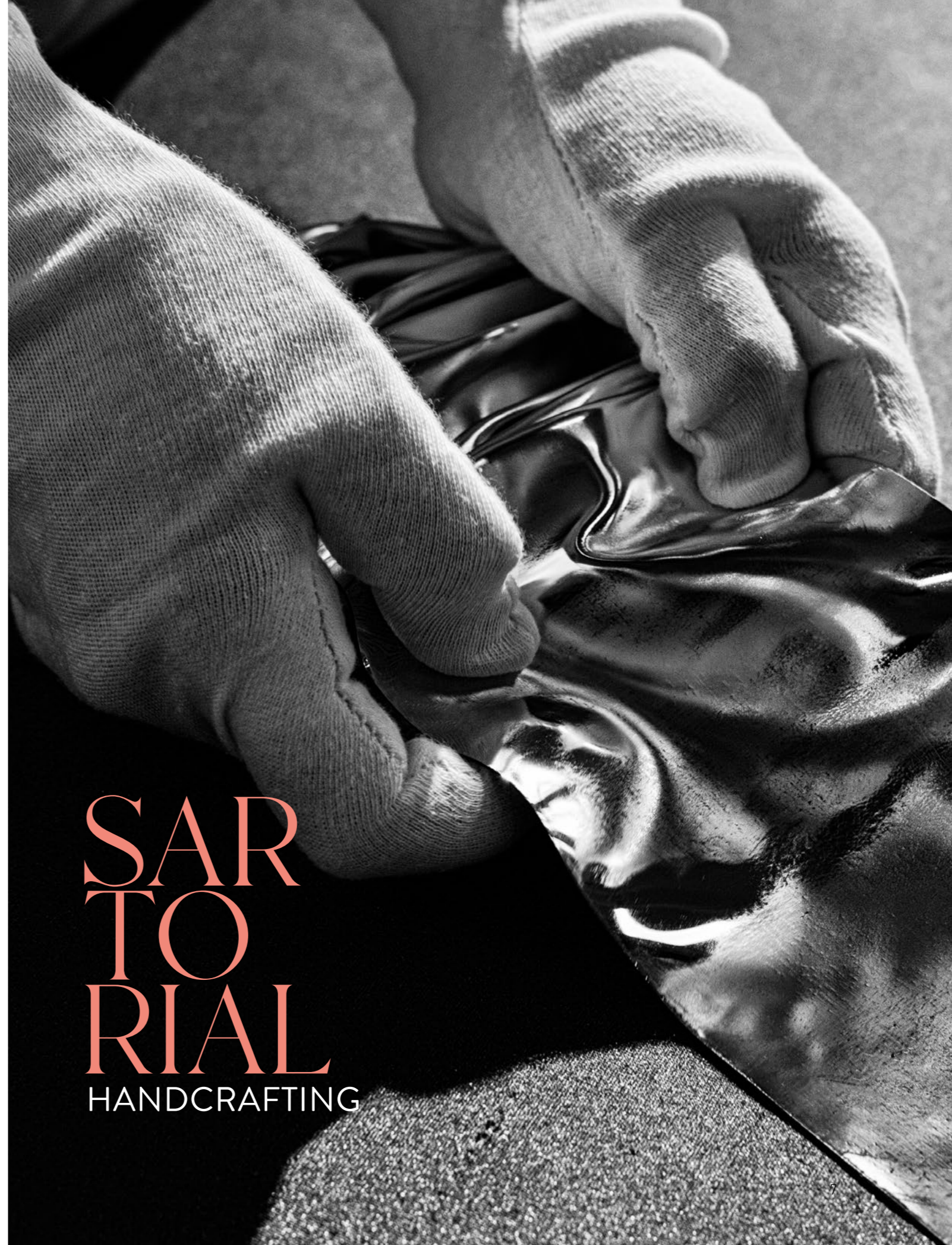

SAR
TO
RIAL
HANDCRAFTING

ACCORDÉON design by Marc Sadler

Compendium page 124 / 130

PRODUCT / PRODOTTO	DIMENSION / MISURE	COLOUR / COLORE	CODE / CODICE	PRICE VAT EXCL. / PREZZO IVA ESCL.
SUSPENSION LED: 52W - 200~240V - 5.900 Lumen 2700 Kelvin or 3.000 Kelvin Dimmable with: PWM / 0-10 With: Hand molded diffusor Made of: Lentiflex® / Goldflex® / Steelflex® Weight: net Kg 4 - gross Kg 6 Package: 63 x 64 x h. 34 cm		<input type="checkbox"/> WHITE - 2700K	ACRSM00WHT01T0027KEU	€ 1.240,00
		<input type="checkbox"/> WHITE - 3000K	ACRSM00WHT01T0030KEU	€ 1.240,00
		<input type="checkbox"/> SILVER - 2700K	ACRSM00SLV01T0027KEU	€ 1.340,00
		<input type="checkbox"/> SILVER - 3000K	ACRSM00SLV01T0030KEU	€ 1.340,00
		<input type="checkbox"/> GOLD - 2700K	ACRSM00GLD01T0027KEU	€ 1.340,00
		<input type="checkbox"/> GOLD - 3000K	ACRSM00GLD01T0030KEU	€ 1.340,00
ADDITIONAL DIMMING SYSTEM DALI, BLUETOOTH, CASAMBI, TRIAC UPON REQUEST				
SUSPENSION VERTICAL Bulbs E14: 1 X 10W max LED Filament max Ø 5 cm / 2" Dimmable with: Dimmable bulbs With: Hand molded diffusor Black wrapped electric wire Made of: Lentiflex® / Brushed Goldflex® Weight: net 0,35 Kg - gross 0,55 Kg Package: 18 x 18 x h. 35 cm		<input type="checkbox"/> PRISMA	ACRSS00PRS01B00000EU	€ 245,00
		<input checked="" type="checkbox"/> GOLD	ACRSS00GLD01B00000EU	€ 286,00

CANOPY DETAILS



ACCORDÉON SUSPENSION

Ø 16 cm x h. 3,5 cm (Ø 6-1/4" x h.1-1/2")
 6m. cable kit must be ordered with lamp purchase
 Kit Cavi da 6m da richiedere tassativamente in fase di ordine



ACCORDÉON SUSPENSION VERTICAL

Ø 5,5 cm x h. 5 cm (Ø 2-1/4" x h. 2")
 6m. cable kit must be ordered with lamp purchase
 Kit Cavi da 6m da richiedere tassativamente in fase di ordine

Kit di installazione multipla su richiesta
 Multiple installation kit on request

ACCORDÉON ENTIRE COLLECTION

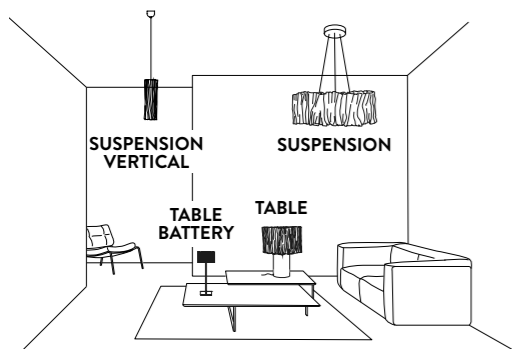

FINISHES



ACCORDÉON TABLE by Marc Sadler

Compendium page 318

PRODUCT / PRODOTTO	DIMENSION / MISURE	COLOUR / COLORE	CODE / CODICE	PRICE VAT EXCL. / PREZZO IVA ESCL.
TABLE Bulbs E27 + E14: 2 X 12W E27 LED + 1 X 6W E14 LED With: Two position light switch Hand molded diffusor Magnetic System® Made of: Cristalflex® / Lentiflex® Weight: net Kg 2,6 - gross Kg 4,5 Package: 61,5 x 46 x h 34,5 cm		<input type="checkbox"/> PRISMA	ACRTM00WHT00000000EU	€ 580,00

ACCORDÉON BATTERY by Marc Sadler

Compendium page 312

PRODUCT / PRODOTTO	DIMENSION / MISURE	COLOUR / COLORE	CODE / CODICE	PRICE VAT EXCL. / PREZZO IVA ESCL.
BATTERY TABLE LED: 1.3W dimmable - 150Lumen 2700 Kelvin - Rechargeable Li-ion Polymer Cell 3.7 Vdc 2500mAh Charge 5 Vdc 1A Battery duration: at max intensity around 6.5 hours duration, at min intensity around 60 hours duration With: USB/DC plug included White base version with white detail in the shade, Black base version with black detail in the shade. Made of: Lentiflex®, Anodized aluminium Weight: net Kg 0.46 - gross Kg 0.80 Package: 19 x 17 x h. 48 cm		<input checked="" type="checkbox"/> PRISMA/BRASS <input type="checkbox"/> WITH WHITE BASE	ACRT000PRW000BT000EU	€ 299,00
		<input checked="" type="checkbox"/> PRISMA/BRASS <input type="checkbox"/> WITH BLACK BASE	ACRT000PRB000BT000EU	€ 299,00
USB MULTICHARGER STATION 20 PORTS With: 20 USB, wire 1,50 m fan automatic heat dissipation Weight: net Kg 0,49 - gross Kg 0,53 Package: 15,5 x 15,5 x h. 7 cm		ACC00CHAP020_000		€ 195,00

ARIA SUSPENSION

by Zaha Hadid

Compendium page 30 / 24 / 28

PRODUCT / PRODOTTO	DIMENSION / MISURE	COLOUR / COLORE	CODE / CODICE	PRICE VAT EXCL. / PREZZO IVA ESCL.
SUSPENSION XL Bulbs E27: 6 X 12W LED Filament + 1 X 11W Spot LED PAR 30 Dimmable with: Dimmable bulbs Made of: Cristalflex® / Lentiflex® Weight: net Kg 23,5 - gross Kg 35,2 Package: A 54 x 55 x h. 44 cm - Kg 6,2 B 65 x 150 x h.13 cm - Kg 29		■ BLACK FADE	ARISXL0BKF01T00E27EU	€ 3.400,00
		■ TRANSP	ARISXL0TRS01T00E27EU	€ 2.650,00
SUSPENSION L Bulbs E27: 4 X 12W LED Filament + 1 X 11W Spot LED PAR 30 Dimmable with: Dimmable bulbs Made of: Cristalflex® / Lentiflex® Weight: net Kg 19,2 - gross Kg 31,7 Package: A 46 x 44 x h. 43 cm - Kg 4,7 B 65 x 150 x h.13 cm - Kg 27		■ TRANSP	ARISL00TRS01T00E27EU	€ 1.900,00
		■ GOLD	ARISL00GLD01T00E27EU	€ 4.500,00
SUSPENSION M Bulbs E27: 3 X 12W LED Filament + 1 X 7 W Spot LED PAR 20 Dimmable with: Dimmable bulbs Made of: Cristalflex® / Lentiflex® Weight: net Kg 12,8 - gross Kg 20,7 Package: A 35 x 35 x h. 32 cm - Kg 2,7 B 65 x 120 x h. 16 cm - Kg 18		■ TRANSP	ARISM00TRS01T00E27EU	€ 1.300,00
		■ GOLD	ARISM00GLD01T00E27EU	€ 2.900,00
SUSPENSION S Bulbs E27: 2 X 12W LED Filament suggested dimension max Ø6 cm (2-1/4\"/> + 1 X 7 W Spot LED PAR20 Dimmable with: Dimmable bulbs Made of: Cristalflex® / Lentiflex® Weight: net Kg 5,3 - gross Kg 13,7 Package: A 35 x 35 x h. 32 cm - Kg 2,2 B 42 x 110 x h. 11 cm - Kg 11,5		■ TRANSP	ARISS00TRS01T00E27EU	€ 980,00
		■ GOLD	ARISS00GLD01T00E27EU	€ 2.200,00

LIGHT SOURCES:

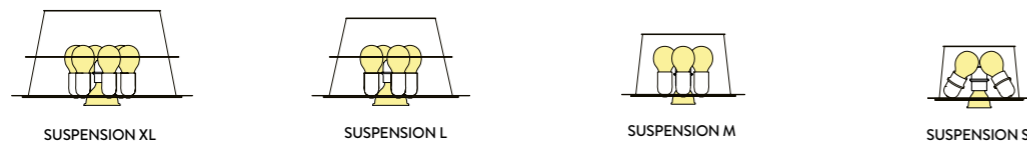

ARIA APPLIQUE

by Zaha Hadid

Compendium page 32

PRODUCT / PRODOTTO	DIMENSION / MISURE	COLOUR / COLORE	CODE / CODICE	PRICE VAT EXCL. / PREZZO IVA ESCL.
WALL LAMP Bulbs E14: 2 X 6W LED Filament + 1 X 6W Spot LED Dimmable with: Dimmable bulbs Made of: Lentiflex® / Cristalflex® Weight: net 2 Kg - gross 7 Kg Package: A: 26 x 28 x h. 16 cm - gross 1,2 kg B: 80 x 40,5 x 7,5 cm - gross 3,8 kg		■ TRANSP	ARIWS00TRS000000000EU	€ 490,00
		■ GOLD	ARIWS00GLD000000000EU	€ 790,00

LIGHT SOURCE

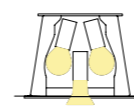

CANOPY DETAILS



ARIA GOLD

L: Ø 16 / Ø 20 cm x h. 3,5 cm (Ø 6-1/4" / Ø 7 -3/4"x h.1-1/2")

M: Ø 12 / Ø 16 cm x h. 3 cm (Ø 4-3/4" / Ø 6- 1/4"x h. 1")

S: Ø 12 / Ø 16 cm x h. 3 cm (Ø 4-3/4" / Ø 6- 1/4"x h. 1")

6 m. cable kit also available for purchase after lamp order
 Kit Cavi da 6m acquistabile anche successivamente

Kit di installazione multipla su richiesta
 Multiple installation kit on request



ARIA BLACK FADE XL

Ø 16 / Ø 20 cm x h. 3,5 cm
 (Ø 6-1/4" / Ø 7 -3/4"x h.1-1/2")

6 m. cable kit also available for purchase after lamp order

Kit Cavi da 6m acquistabile anche successivamente - Kit di installazione multipla su richiesta - Multiple installation kit on request



ARIA TRANSPARENT

XL / L: Ø 16 / Ø 20 cm x h. 3,5 cm

(Ø 6-1/4" / Ø 7 -3/4"x h.1-1/2")

S / M: Ø 12 / Ø 16 cm x h. 3 cm

(Ø 4-3/4" / Ø 6- 1/4"x h. 1")

6 m. cable kit also available for purchase after lamp order
 Kit Cavi da 6m acquistabile anche successivamente



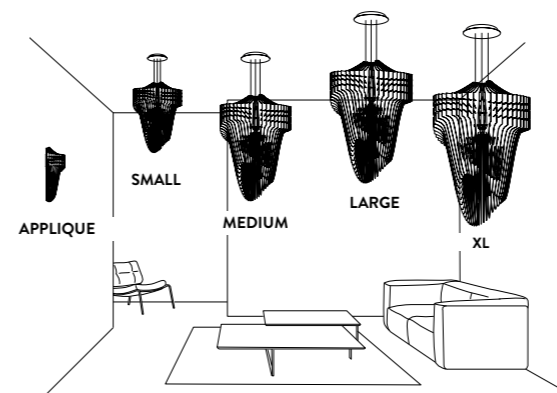

Kit di installazione multipla su richiesta
 Multiple installation kit on request

ARIA ENTIRE COLLECTION

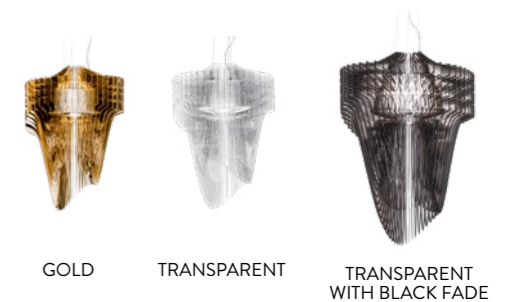

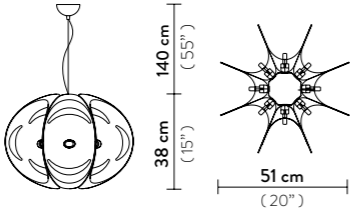
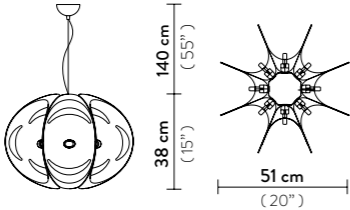
FINISHES

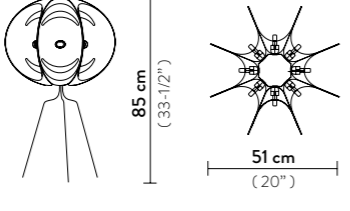

PRODOTTI	MISURE	COLORI	CODICI	PRICE VAT EXCL. / PREZZO IVA ESCL.
SUSPENSION Bulbs E14:  8 X 15W max IBC/C Made of: Cristalflex® Weight: net Kg 2,35 - gross Kg 4 Package: 55 x 56 x h. 45 cm		 FUMÉ	ATLSS00FUM01T00000EU	€ 550,00
FLOOR - TABLE LAMP Bulbs E14:  8 X 15W max IBC/C Made of: Cristalflex® With: Stainless steel structure Weight: net Kg 3,6 - gross Kg 7,4 Package: 60 x 60 x h. 62 cm		 FUMÉ	ATLTM00FUM00000000EU	€ 620,00

CANOPY DETAILS



ATLANTE SUSPENSION

Ø 12 cm x h. 6 cm (Ø 4-3/4" x h. 2-1/4")
 6m. cable kit must be ordered with lamp purchase
Kit Cavi da 6m da richiedere tassativamente in fase di ordine
 Kit di installazione multipla su richiesta
Multiple installation kit on request

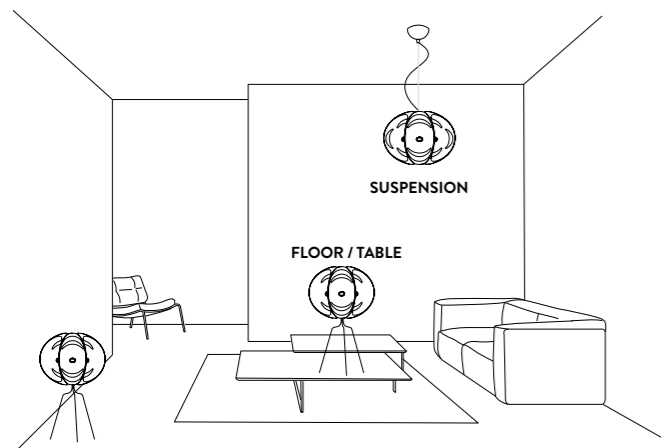

ATLANTE ENTIRE COLLECTION



FINISHES

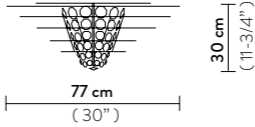
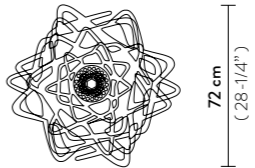

FUMÉ

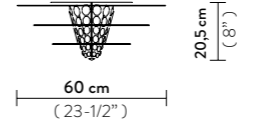
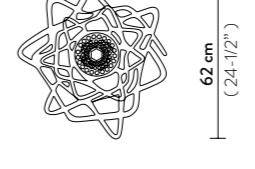
PRODUCT / PRODOTTO	DIMENSIONS / MISURE	COLOUR / COLORE	CODE / CODICE	PRICE VAT EXCL. / PREZZO IVA ESCL.
CEILING LAMP LARGE Bulbs E27:  1 X 12W LED Filament Dimmable with: Dimmable bulbs Made of: Plainflex® / 97 Crystals With: MagneticSystem® Weight: net Kg 6,5 - gross Kg 9,5 Package: A 34 x 35 x h. 37 cm - Kg 3,5 B 80 x 80 x h. 10 cm - Kg 6	 	<input type="checkbox"/> WHITE <input checked="" type="checkbox"/> BLACK	AURCL00WHT00000000EU AURCL00BLK00000000EU	€ 820,00 € 820,00
CEILING LAMP MINI Bulbs E27:  1 X 12W LED Filament Dimmable with: Dimmable bulbs Made of: Plainflex® or Cristalflex® / 61 Crystals With: MagneticSystem® Weight: net Kg 1,7 - gross Kg 3,1 Package: A 23 x 23 x h. 15 cm - Kg 2,2 B 62 x 60 x h. 8 cm - Kg 0,9	 	<input checked="" type="checkbox"/> TRANSP. <input type="checkbox"/> WHITE <input checked="" type="checkbox"/> BLACK <input type="checkbox"/> FUMÉ	AURCS00TRS00000000EU AURCS00WHT00000000EU AURCS00BLK00000000EU AURCS00FUM00000000EU	€ 490,00 € 490,00 € 490,00 € 490,00

AURORA ENTIRE COLLECTION

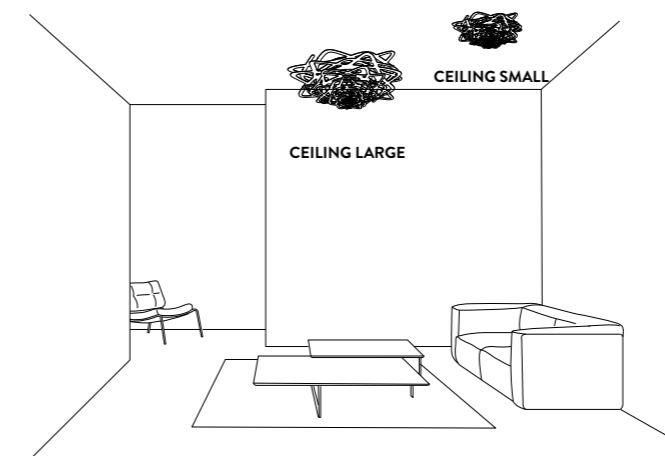

FINISHES



TRANSPARENT



FUMÉ



BLACK



WHITE

PRODUCT / PRODOTTO	DIMENSIONS / MISURE	COLOUR / COLORE	CODE / CODICE	PRICE/VAT EXCL. / PREZZO IVA ESCL.
SUSPENSION Bulbs E27: 2 X 12W LED Filament Dimmable with: Dimmable bulbs Made of: Methacrylate / Goldflex® or Pewterflex® With: Hand - finished Sphere Weight: net Kg 1,0 - gross Kg 2,0 Package: 34,5 x 34,5 x h. 46 cm		■ GOLD	ATSSM00GLD01T00000EU	€ 330,00
		■ PEWTER	ATSSM00PWT01T00000EU	€ 330,00
TABLE MEDIUM Bulbs E27: 2 X 12W LED Filament Made of: Methacrylate / Goldflex® or Pewterflex® With: Hand - finished Sphere Two positions light switch Weight: net Kg 1,55 - gross Kg 2,55 Package: 34 x 34 x h. 49,5 cm		■ GOLD	ATSTM00GLD000000000EU	€ 380,00
		■ PEWTER	ATSTM00PWT000000000EU	€ 380,00
TABLE SMALL Bulbs G9: 2 X 6W LED Made of: Methacrylate / Goldflex® or Pewterflex® With: Hand - finished Sphere Weight: net Kg 0,7 - gross Kg 1,7 Package: 23,5 x 23,5 x h. 44 cm		■ GOLD	ATSTS00GLD000000000EU	€ 295,00
		■ PEWTER	ATSTS00PWT000000000EU	€ 295,00



CANOPY DETAILS



ATMOSFERA SUSPENSION

Ø 12 cm x h. 3,2 cm (Ø 4-3/4" x h. 1-1/4")

6m. cable kit must be ordered with lamp purchase
 Kit Cavi da 6m da richiedere tassativamente in fase di ordine

Kit di installazione multipla su richiesta
 Multiple installation kit on request

ATMOSFERA ENTIRE COLLECTION

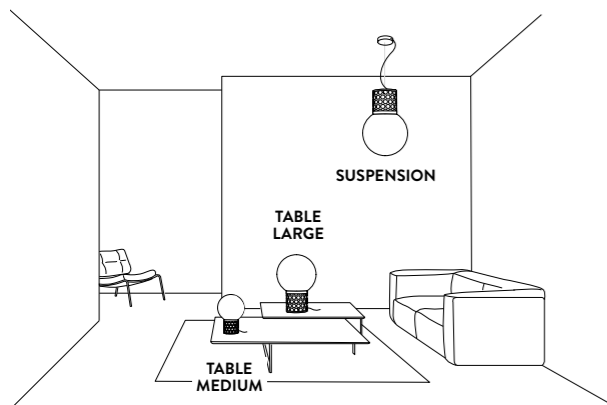

FINISHES



PEWTER

GOLD

PRODUCT / PRODOTTO	DIMENSIONS / MISURE	COLOUR / COLORE	CODE / CODICE	PRICE VAT EXCL. / PREZZO IVA ESCL.
SUSPENSION XL Bulbs E27: 6 X 12W LED Filament + 1 X 11W Spot LED PAR 30 Dimmable with: Dimmable bulbs Made of: Cristalflex® / Lentiflex® Weight: net Kg 20,5 - gross Kg 32,7 Package: A 54 x 55 x h. 44 cm - Kg 6,2 B 65 x 150 x h. 13 cm - Kg 26,5		■ BLACK FADE AVISXLOBKF01T00000EU € 2.800,00		
		■ WHITE FADE AVISXLOWHF01T00000EU € 2.800,00		
SUSPENSION L Bulbs E27: 4 X 12W LED Filament + 1 X 11W Spot LED PAR 30 Dimmable with: Dimmable bulbs Made of: Cristalflex® / Lentiflex® Weight: net Kg 14,85 - gross Kg 22,2 Package: A 46 x 44 x h. 43 cm - Kg 4,7 B 65 x 120 x h. 16 cm - Kg 17,5		■ BLACK FADE AVISL00BKF01T00000EU € 2.100,00		
		■ WHITE FADE AVISL00WHF01T00000EU € 2.100,00		
SUSPENSION M Bulbs E27: 3 X 12W LED Filament + 1 X 7W Spot LED PAR 20 Dimmable with: Dimmable bulbs Made of: Cristalflex® / Lentiflex® Weight: net Kg 10,2 - gross Kg 16,2 Package: A 35 x 35 x h. 32 cm - Kg 2,7 B 44 x 110 cm x h. 13 cm - Kg 13,5		■ BLACK FADE AVISM00BKF01T00000EU € 1.490,00		
		■ WHITE FADE AVISM00WHF01T00000EU € 1.490,00		
SUSPENSION S Bulbs E27: 2 X 12W LED Filament suggested dimension max Ø6 cm (2-1/4") + 1 X 7W Spot LED PAR 20 Dimmable with: Dimmable bulbs Made of: Cristalflex® / Lentiflex® Weight: net Kg 5,3 - gross Kg 10,7 Package: A 35 x 35 x h. 32 cm - Kg 2,7 B 38 x 90 x h. 14 cm - Kg 8,5		■ BLACK FADE AVISS00BKF01T00000EU € 1.100,00		
		■ WHITE FADE AVISS00WHF01T00000EU € 1.100,00		

PRODUCT / PRODOTTO	DIMENSIONS / MISURE	COLOUR / COLORE	CODE / CODICE	PRICE VAT EXCL. / PREZZO IVA ESCL.
SUSPENSION M Bulbs E27: 3 X 12W LED Filament + 1 X 7W Spot LED PAR20 Dimmable with: Dimmable bulbs Made of: Cristalflex® / Lentiflex® Weight: net Kg 10,2 - gross Kg 16,2 Package: A 35 x 35 x h. 32 cm - Kg 2,7 B 44 x 110 cm x h. 13 cm - Kg 13,5		■ BLUE AVISM00BLU01T00000EU € 1.800,00		
		■ TURQUOISE AVISM00TRQ01T00000EU € 1.800,00		



L'AUTENTICITÀ DI OGNI SINGOLO PEZZO DI AVIA EDITION È GARANTITA DAL NUMERO PROGRESSIVO RIPORTATO SULLA LAMPADA
 THE AUTHENTICITY OF EACH AVIA EDITION PIECE IS GUARANTEED NUMERICALLY, STATED ON THE LAMP AND ID CARD.

LIGHT SOURCES:

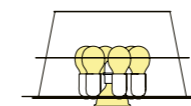

SUSPENSION XL

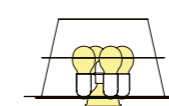

SUSPENSION L

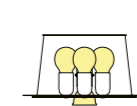

SUSPENSION M

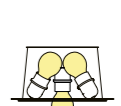

SUSPENSION S

CANOPY DETAILS



BLACK VERSION



WHITE VERSION
EDITION VERSION

AVIA

XL: Ø 16 / Ø 20 cm x h. 3,5 cm (Ø 6-1/4" / Ø 7-3/4" x h. 1-1/2")

L: Ø 16 / Ø 20 cm x h. 3,5 cm (Ø 6-1/4" / Ø 7-3/4" x h. 1-1/2")

M: Ø 12 / Ø 16 cm x h. 3 cm (Ø 4-3/4" / Ø 6-1/4" x h. 1")

S: Ø 12 / Ø 16 cm x h. 3 cm (Ø 4-3/4" / Ø 6-1/4" x h. 1")

Kit di installazione multipla su richiesta
 Multiple installation kit on request
 6 m. cable kit also available for purchase after lamp order
 Kit Cavi da 6m acquistabile anche successivamente

AVIA ENTIRE COLLECTION

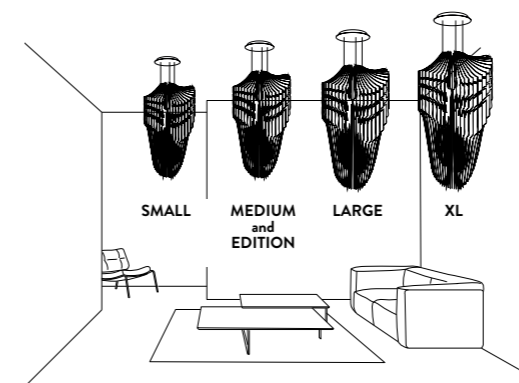

FINISHES

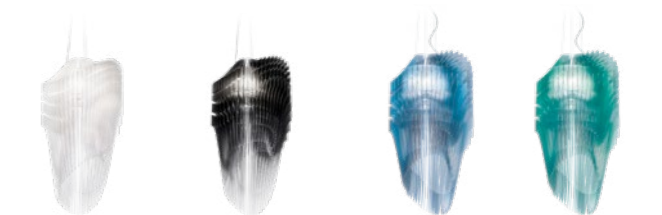

WHITE FADE

BLACK FADE

BLUE

TURQUOISE

PRODUCT / PRODOTTO	DIMENSIONS / MISURE	COLOUR / COLORE	CODE / CODICE	PRICE VAT EXCL. / PREZZO IVA ESCL.
FLOOR LAMP XXL Bulbs E27: 3 X 12W LED Filament Dimmable with: Dimmable bulbs Made of: Opalflex® With: Stainless Steel base - Dimmer Weight: net Kg 4 - gross Kg 6,6 Package: 35 x 30 x h. 184 cm		<input type="checkbox"/> WHITE	BACFXXLWHT00000000EU	€ 560,00
		<input type="checkbox"/> GOLD	BACFXXLGLD00000000EU	€ 560,00
FLOOR LAMP XL Bulbs E27: 3 X 12W LED Filament Dimmable with: Dimmable bulbs Made of: Opalflex® With: Stainless Steel base - Dimmer Weight: net Kg 3 - gross Kg 6,2 Package: 30 x 35 x 170 cm		<input type="checkbox"/> WHITE	BACFXLOWHT00000000EU	€ 480,00
		<input type="checkbox"/> GOLD	BACFXLGLD00000000EU	€ 480,00
FLOOR LAMP L Bulbs E27: 2 X 12W LED Filament Made of: Opalflex® With: Stainless Steel base Weight: net Kg 2,56 - gross Kg 4 Package: 28 x 35 x h. 123 cm		<input type="checkbox"/> WHITE	BACFL00WHT00000000EU	€ 310,00
		<input type="checkbox"/> GOLD	BACFL00GLD00000000EU	€ 310,00
TABLE LAMP M Bulbs E27: 1 X 12W LED Filament Made of: Opalflex® With: Stainless Steel base Weight: net Kg 1,29 - gross Kg 1,9 Package: 25 x 24 x h. 76 cm		<input type="checkbox"/> WHITE	BACTM00WHT00000000EU	€ 195,00
		<input type="checkbox"/> GOLD	BACTM00GLD00000000EU	€ 195,00

PRODUCT / PRODOTTO	DIMENSIONS / MISURE	COLOUR / COLORE	CODE / CODICE	PRICE VAT EXCL. / PREZZO IVA ESCL.
TABLE LAMP S Bulbs E14: 1 X 6W LED Filament Dimmable with: Dimmable bulbs Made of: Opalflex® With: Stainless Steel base Weight: net Kg 0,58 - gross Kg 1 Package: 17 x 20 x h. 48 cm		<input type="checkbox"/> WHITE	BACTS00WHT00000000EU	€ 155,00
		<input type="checkbox"/> GOLD	BACTS00GLD00000000EU	€ 155,00

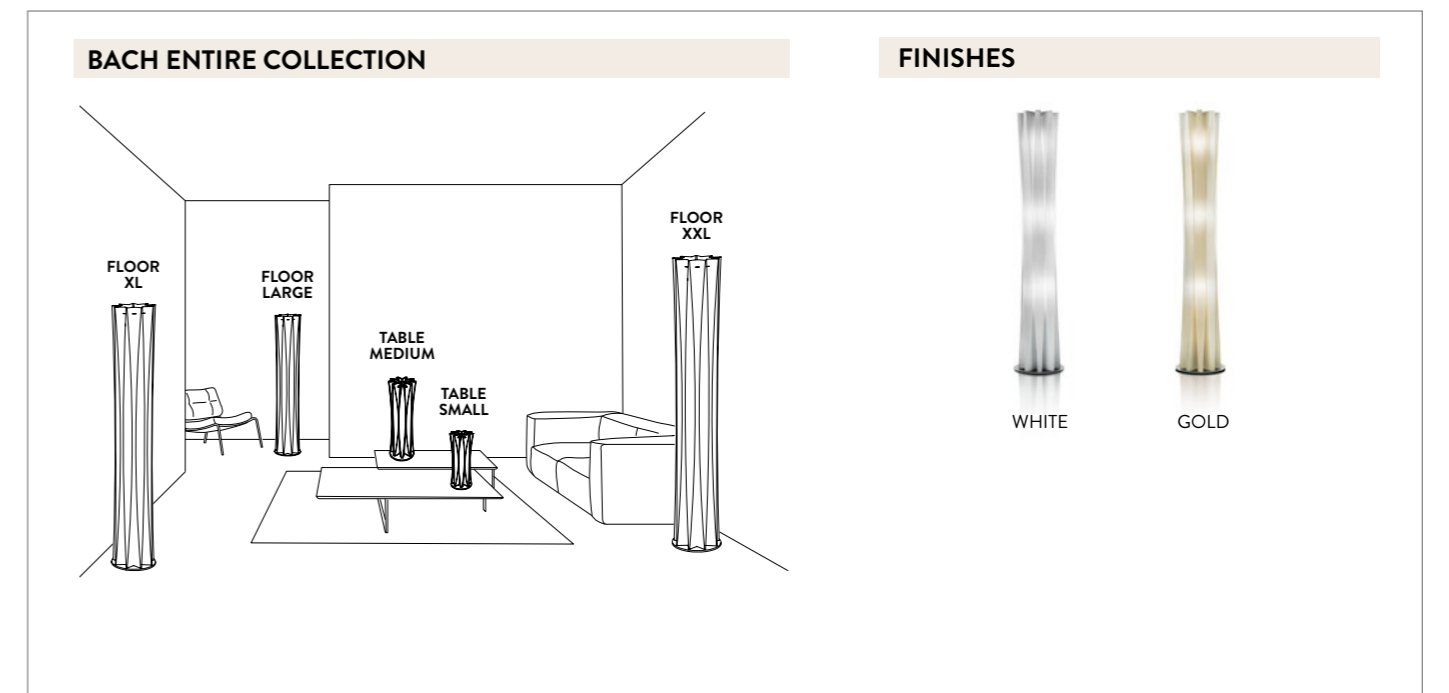

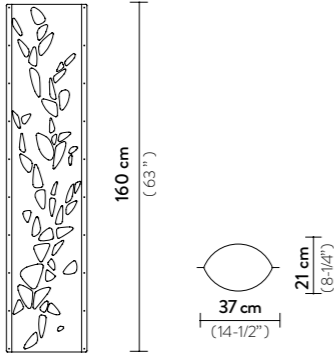
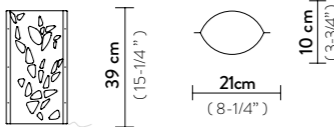
PRODUCT / PRODOTTO	DIMENSIONS / MISURE	COLOUR / COLORE	CODE / CODICE	PRICE VAT EXCL. / PREZZO IVA ESCL
FLOOR LAMP Bulbs E27: 3 X 12W LED Filament Dimmable with: Dimmable bulbs Made of: Opalflex® With: Dimmer Weight: net Kg 2,80 - gross Kg 6,00 Package: 37 x 28 x h168cm		<input type="checkbox"/> WHITE	TUBFXL0BIO00000000EU	€ 490,00
TABLE LAMP Bulbs E14: 1 X 6W LED Filament Made of: Opalflex® Weight: net Kg 0,40 - gross Kg 0,70 Package: 26 x 6 x h43cm		<input type="checkbox"/> WHITE	TUBTS00BIO00000000EU	€ 130,00

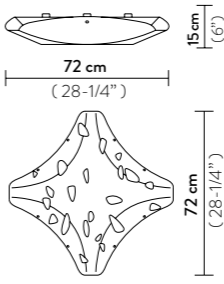
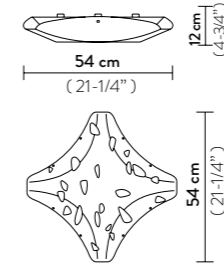
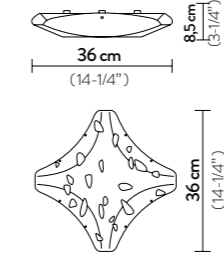

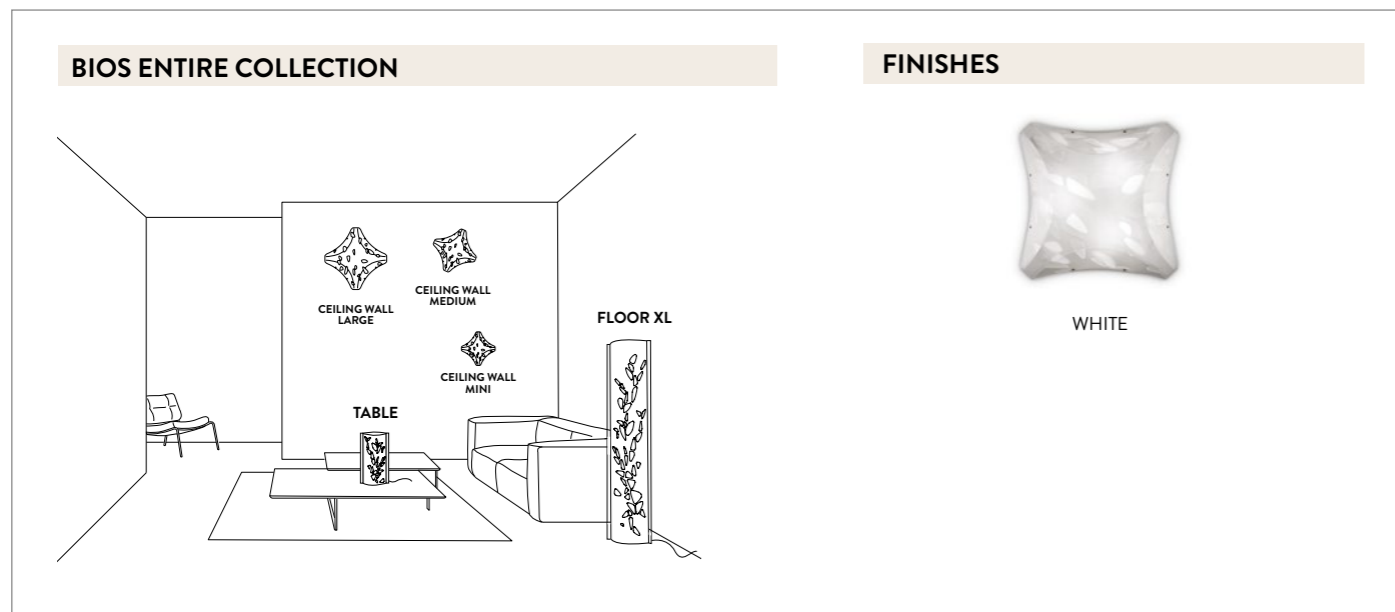

PRODUCT / PRODOTTO	DIMENSIONS / MISURE	COLOUR / COLORE	CODE / CODICE	PRICE VAT EXCL. / PREZZO IVA ESCL
CEILING WALL LAMP LARGE Bulbs E27: 4 X 12W LED Filament Dimmable with: Dimmable bulbs Made of: Opalflex® With: MagneticSystem® Weight: net Kg 3,00 - gross Kg 5,50 Package: 80 x 80 x h. 25 cm		<input type="checkbox"/> WHITE	BIOCLO0WHT00000000EU	€ 320,00
CEILING WALL LAMP MEDIUM Bulbs E27: 3 X 12W LED Filament Dimmable with: Dimmable bulbs Made of: Opalflex® With: MagneticSystem® Weight: net Kg 2,00 - gross Kg 3,00 Package: 57 x 57 x 22 cm		<input type="checkbox"/> WHITE	BIOCM00WHT00000000EU	€ 220,00
CEILING WALL LAMP SMALL Bulbs E27: 2 X 12W LED Filament Dimmable with: Dimmable bulbs Made of: Opalflex® With: MagneticSystem® Weight: net Kg 0,60 - gross Kg 1,00 Package: 39 x 36 x h9,5cm		<input type="checkbox"/> WHITE	BIOCS00WHT00000000EU	€ 160,00



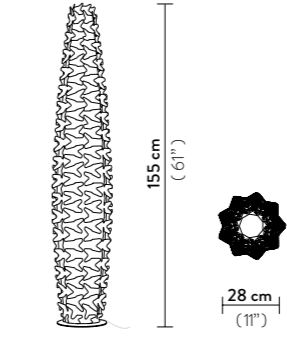

ph. Pedro Sadio

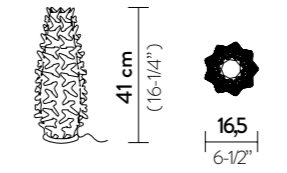
CACTUS PRISMA design by Adriano Rachele Compendium page **484 / 370**

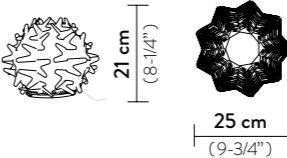
PRODUCT / PRODOTTO	DIMENSIONS / MISURE	COLOUR / COLORE	CODE / CODICE	PRICE VAT EXCL. / PREZZO MAESCL.
FLOOR LAMP XL Bulbs E27:  2 X 12W LED Filament Made of: Lentiflex® / Stainless Steel base With: Dimmer Weight: net Kg 3,13 - gross Kg 6,7 Package: 44 x 45 x h. 157 cm		<input type="checkbox"/> PRISMA	CACFXL0PRS00000000EU	€ 630,00
TABLE LAMP XM Bulbs E14:  1 X 6W LED Filament Made of: Lentiflex® / Stainless Steel base Weight: net Kg 1,03 - gross Kg 2 Package: 25 x 24 x h. 41 cm		<input type="checkbox"/> PRISMA	CACTXM0PRS00000000EU	€ 195,00
TABLE LAMP XS Bulbs E14:  1 X 6W LED Filament Made of: Lentiflex® / Stainless Steel base Weight: net Kg 0,98 - gross Kg 1,2 Package: 28 x 28 x h. 25 cm		<input type="checkbox"/> PRISMA	CACTXS0PRS00000000EU	€ 155,00

CACTUS PRISMA ENTIRE COLLECTION

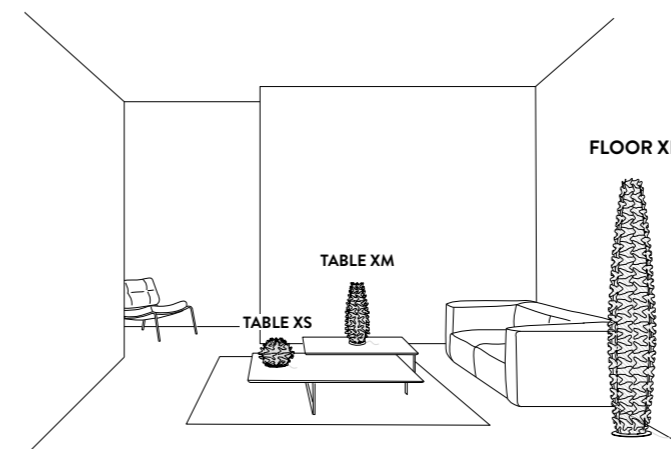

FINISHES







PRISMA

CACTUS GOLD

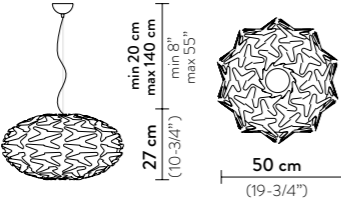
design by Adriano Rachele

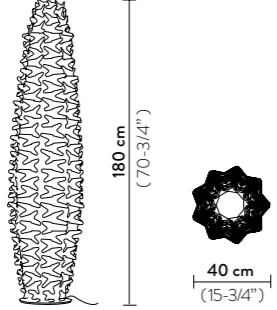
Compendium page **216 / 482 / 370**

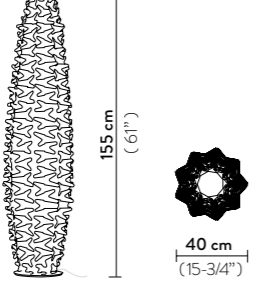
PRODUCT / PRODOTTO	DIMENSIONS / MISURE	COLOUR/COLORE	CODE / CODICE	PRICE VAT EXCL. / PREZZO IVA ESCL.
SUSPENSION Bulbs E27:  1 X 12W LED Filament Dimmable with: Dimmable bulbs Made of: Opalflex® Weight: net Kg 1,05 - gross Kg 3 Package: 55 x 55 x h. 44 cm		■ GOLD	CACSM00GLD01T000000EU	€ 245,00
FLOOR LAMP XXL Bulbs E27:  2 X 12W LED Filament Made of: Opalflex® With: Stainless Steel base Weight: net Kg 3,5 - gross Kg 8,2 Package: 44 x 45 x h. 182 cm		■ GOLD	CACFXLGLD00000000EU	€ 560,00
FLOOR LAMP XL Bulbs E27:  2 X 12W LED Filament Made of: Opalflex® With: Stainless Steel base Weight: net Kg 3,13 - gross Kg 6,7 Package: 44 x 45 x h. 157 cm		■ GOLD	CACFXL0GLD00000000EU	€ 480,00

CANOPY DETAILS





CACTUS SUSPENSION

Ø10 cm x h. 5,5 cm (Ø 4" x h. 2")

6m. cable kit must be ordered with lamp purchase
Kit Cavi da 6m da richiedere tassativamente in fase di ordine

Kit di installazione multipla su richiesta
Multiple installation kit on request

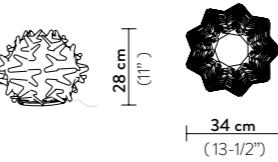
PRODUCT / PRODOTTO	DIMENSIONS / MISURE	COLOUR/COLORE	CODE / CODICE	PRICE VAT EXCL. / PREZZO IVA ESCL.
TABLE LAMP M Bulbs E14:  1 X 6W LED Filament Made of: Opalflex® / Stainless Steel base Weight: net Kg 0,86 - gross Kg 1,4 Package: 24 x 23 x h. 43 cm		■ GOLD	CACM00GLD00000000EU	€ 195,00
TABLE LAMP S Bulbs E14:  1 X 6W LED Filament Made of: Opalflex® / Stainless Steel base Weight: net Kg 0,68 - gross Kg 1,5 Package: 40 x 40 x h. 30 cm		■ GOLD	CACT500GLD00000000EU	€ 155,00

CACTUS GOLD ENTIRE COLLECTION

FINISHES

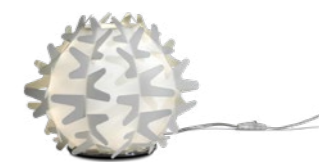
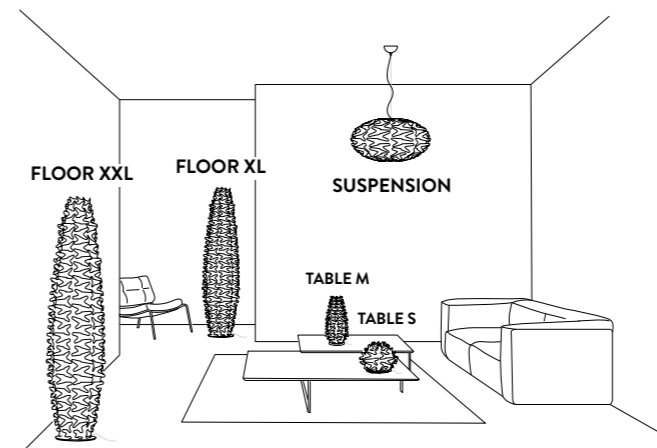

GOLD

PRODUCT / PRODOTTO	DIMENSIONS / MISURE	COLOUR / COLORE	CODE / CODICE	PRICE VAT EXCL. / PREZZO IVA ESCL.
SUSPENSION LARGE Bulbs E27: 4 X 12W LED Filament + 1 X 8W GU10 Spot LED Dimmable with: Dimmable bulbs Made of: Lentiflex® / Cristalflex® Fumè Opalflex Porcelaine® Weight: net Kg 15,00 - gross Kg 22 Package: 102 x 104 x h. 33 cm		<input type="checkbox"/> WHITE	CERSOVSWHT01T000000EU	€ 2.200,00
		<input type="checkbox"/> PRISMA	CERSOVSPRS01T000000EU	€ 2.200,00
		<input type="checkbox"/> FUMÉ	CERSOVSFUM01T000000EU	€ 2.200,00
SUSPENSION SMALL Bulbs E27: 3 X 12W LED Filament + 1 X 8W GU10 Spot Dimmable with: Dimmable bulbs Made of: Lentiflex® / Cristalflex® Fumè Opalflex Porcelaine® Weight: net Kg 5 - gross Kg 5,8 Package: 60 x 60 x h. 25 cm		<input type="checkbox"/> WHITE	CERSM00WHT01T000000EU	€ 1.100,00
		<input type="checkbox"/> PRISMA	CERSM00PRS01T000000EU	€ 1.100,00
		<input type="checkbox"/> FUMÉ	CERSM00FUM01T000000EU	€ 1.100,00

CANOPY DETAILS



CEREMONY SMALL

LARGE: Ø 14 cm x h. 3 cm (Ø 5-1/2" x h. 1")
SMALL: Ø 14 cm x h. 3 cm (Ø 5-1/2" x h. 1")

6m. cable kit must be ordered with lamp purchase
Kit Cavi da 6m da richiedere tassativamente in fase di ordine
 Kit di installazione multipla su richiesta
Multiple installation kit on request

CEREMONY ENTIRE COLLECTION

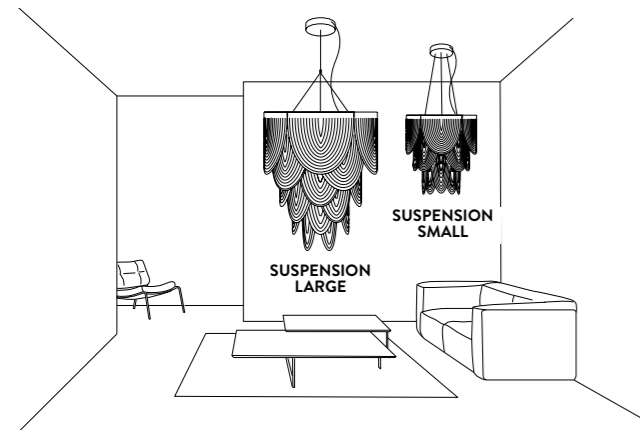

FINISHES



PRODUCT / PRODOTTO	DIMENSIONS / MISURE	COLOUR / COLORE	CODE / CODICE	PRICE VAT EXCL. / PREZZO IVA ESCL.
SUSPENSION M Bulbs E27: 7 X 12W LED Filament Dimmable with: Dimmable bulbs Made of: Cristalflex® / Lentiflex® Weight: net Kg 4,1 - gross Kg 10 Package: 61 x 61 x h. 107 cm		ORANGE	CHNSM00ORG01T00E27EU	€ 1.280,00
		BLUE	CHNSM00BLU01T00E27EU	€ 1.280,00
		WHITE	CHNSM00WHT01T00E27EU	€ 1.280,00
SUSPENSION S Bulbs E27: 4 X 12W LED Filament + Dimmable with: Dimmable bulbs Made of: Cristalflex® / Lentiflex® With: MagneticSystem® Weight: net Kg 2,5 - gross Kg 5,5 Package: 45 x 45 x h. 82 cm		ORANGE	CHNSS00ORG01T00E27EU	€ 720,00
		BLUE	CHNSS00BLU01T00E27EU	€ 720,00
		WHITE	CHNSS00WHT01T00E27EU	€ 720,00

CANOPY DETAILS



M/S: Ø 12 cm x h. 3,2 cm (Ø4-3/4" x h 1-1/4")

6m. cable kit must be ordered with lamp purchase
 Kit Cavi da 6m da richiedere tassativamente in fase di ordine

Kit di installazione multipla su richiesta
 Multiple installation kit on request

CHANTAL ENTIRE COLLECTION

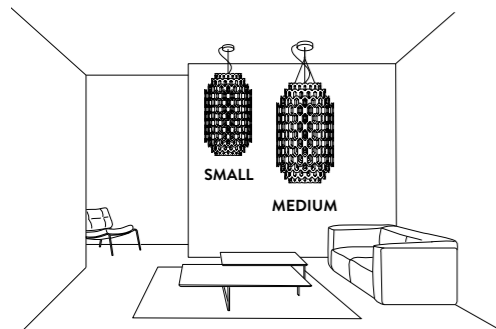

FINISHES



PRODUCT / PRODOTTO	DIMENSIONS / MISURE	COLOUR / COLORE	CODE / CODICE	PRICE VAT EXCL. / PREZZO IVA ESCL.
FLOOR Bulbs E27: 2 X 12W LED Dimmable (filament or spot LED) Made of: Cristalflex® / Lentiflex® With: Dimmer Weight: net Kg 5,2 - gross Kg 11 Package: A: 37 x 36 x h. 188 cm - 7 kg B: 47 x 47 x h. 7 cm - 4 kg		WHITE	CHRF000WHT000BB000EU	€ 930,00

CHARLOTTE ENTIRE COLLECTION

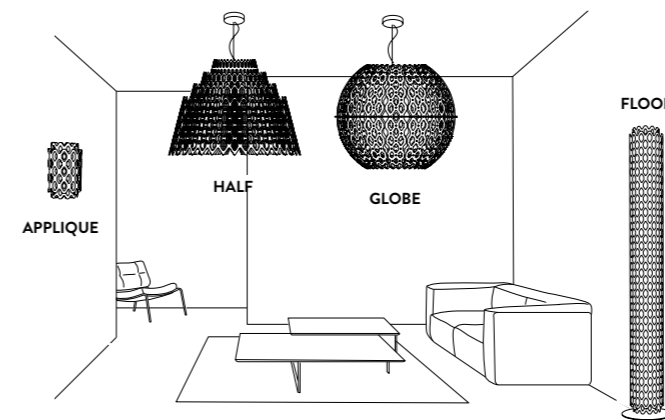



FINISHES



CHARLOTTE

by Doriana and Massimiliano Fuksas

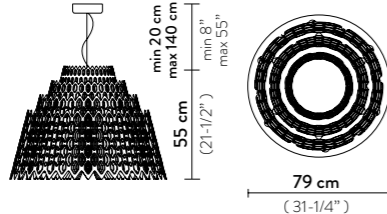
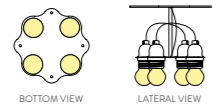
Compendium page 50 / 46 / 54

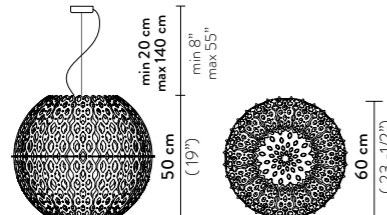
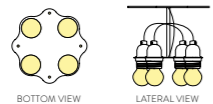
PRODUCT / PRODOTTO	DIMENSIONS / MISURE	COLOUR/COLORE	CODE / CODICE	PRICE VAT EXCL. / PREZZO IVA ESCL.
SUSPENSION HALF Bulbs E27:  4 X 12W LED Filament Dimmable with: Dimmable bulbs Made of: Cristalflex® / Lentiflex® Weight: net Kg 10 - gross Kg 11,65 Package: 90 x 90 x h. 68 cm	 LIGHT SOURCE: 	<input type="checkbox"/> WHITE	CHRSL00WHT01THCE27EU	€ 1.400,00
SUSPENSION GLOBE Bulbs E27:  4 X 12W LED Filament Dimmable with: Dimmable bulbs Made of: Cristalflex® / Lentiflex® With: MagneticSystem® Weight: net Kg 4 - gross Kg 8 Package: 72 x 72 x h. 64 cm	 LIGHT SOURCE: 	<input type="checkbox"/> WHITE	CHRSM00WHT01TGB000EU	€ 800,00

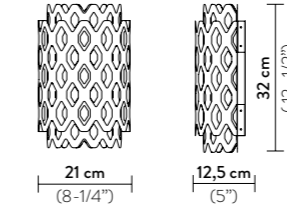
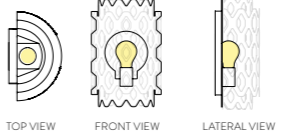
PRODUCT / PRODOTTO	DIMENSIONS / MISURE	COLOUR/COLORE	CODE / CODICE	PRICE VAT EXCL. / PREZZO IVA ESCL.
WALL LAMP Bulbs E27:  1 X 12W LED Filament Dimmable with: Dimmable bulbs Made of: Cristalflex® / Lentiflex® With: Steelflex® Support Weight: net Kg 0,5 - gross Kg 1 Package: 36 x 38 x h. 15 cm	 LIGHT SOURCE: 	<input type="checkbox"/> WHITE	CHRWM00WHT00000000EU	€ 170,00

CANOPY DETAILS

CHARLOTTE GLOBE
 Ø 12 cm x h. 3,2 cm (Ø 4-3/4" x h. 1-1/4")
 6m. cable kit must be ordered with lamp purchase
Kit Cavi da 6m da richiedere tassativamente in fase di ordine
 Kit di installazione multipla su richiesta
Multiple installation kit on request

HALF CHARLOTTE
 Ø 14 cm x h. 3 cm (Ø 5-1/2" x h. 1")
 6m. cable kit must be ordered with lamp purchase
Kit Cavi da 6m da richiedere tassativamente in fase di ordine
 Kit di installazione multipla su richiesta
Multiple installation kit on request

CHARLOTTE ENTIRE COLLECTION

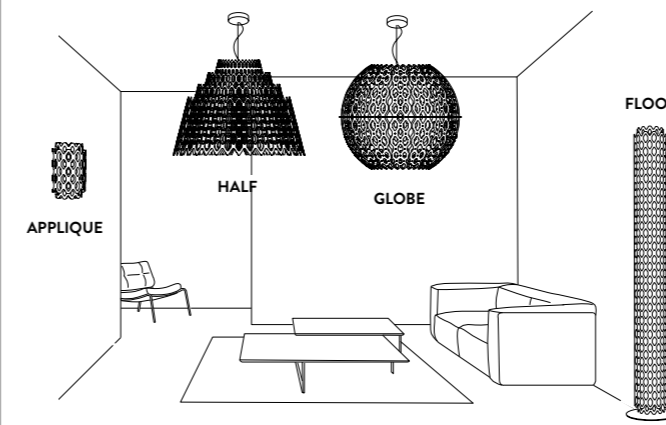



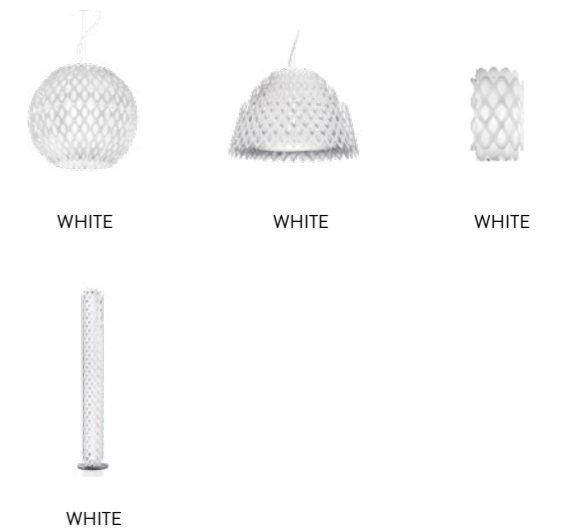





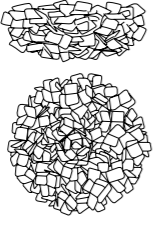
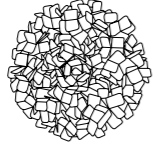



























FINISHES







CLIZIA CEILING / WALL by Adriano Rachele

Compendium page 288 / 286 / 422 / 282 284 / 418 / 420
+ Clizia 10th Anniversary Catalogue

PRODUCT / PRODOTTO	DIMENSIONS / MISURE	COLOUR / COLORE	CODE / CODICE	PRICE VAT EXCL. / PREZZO IVA ESCL.		
CEILING / WALL LARGE Bulbs E27:  3 X 12W LED Filament Dimmable with: Dimmable bulbs Made of: Opalflex® / Cristalflex® / Lentiflex® With: Magnetic Hanging System Weight: net Kg 4,5 - gross Kg 6,5 Package: 80 x 80 x h. 30 cm	 25 cm (9-3/4")  78 cm (30-3/4") LIGHT SOURCE:  37 cm 14-1/4"	 MAMA NON MAMA GOLD	CLICL00GNM00000000EU	€ 729,00		
		 MAMA NON MAMA BLACK	CLICL00BNM00000000EU	€ 620,00		
		 MAMA NON MAMA WHITE	CLICL00MNM00000000EU	€ 620,00		
		 PIXEL	CLICL00PXL00000000EU	€ 620,00		
		 FUMÉ	CLICL00FUM00000000EU	€ 590,00		
		 WHITE	CLICL00WHT00000000EU	€ 490,00		
		 ORANGE	CLICL00ORG00000000EU	€ 490,00		
		 PURPLE	CLICL00PRP00000000EU	€ 490,00		
		CEILING / WALL MEDIUM Bulbs E27:  2 X 12W LED Filament Dimmable with: Dimmable bulbs Made of: Opalflex® / Cristalflex® / Lentiflex® With: Magnetic Hanging System Weight: net Kg 2 - gross Kg 2,7 Package: 57 x 55 x h. 23 cm	 20 cm 8"  53 cm (20-3/4") LIGHT SOURCE:  26 cm 10 - 1/4"	 MAMA NON MAMA GOLD	CLICM00GNM00000000EU	€ 368,00
				 MAMA NON MAMA BLACK	CLICM00BNM00000000EU	€ 310,00
 MAMA NON MAMA WHITE	CLICM00MNM00000000EU			€ 310,00		
 PIXEL	CLICM00PXL00000000EU			€ 310,00		
 FUMÉ	CLICM00FUM00000000EU			€ 290,00		
 WHITE	CLICM00WHT00000000EU			€ 260,00		
 ORANGE	CLICM00ORG00000000EU			€ 260,00		
 PURPLE	CLICM00PRP00000000EU			€ 260,00		
 BLUE	CLICM00BLU00000000EU			€ 260,00		
CEILING / WALL MINI Bulbs E14:  2 X 6W LED Filament Dimmable with: Dimmable bulbs Made of: Opalflex® / Cristalflex® / Lentiflex® With: Magnetic Hanging System Weight: net Kg 0,6 - gross Kg 1,4 Package: 36 x 38 x h. 15 cm	 15 cm 5-3/4"  32 cm (12-1/2") LIGHT SOURCE:  19 cm 7-1/4"			 MAMA NON MAMA GOLD	CLICS00GNM00000000EU	€ 235,00
		 MAMA NON MAMA BLACK	CLICS00BNM00000000EU	€ 204,00		
		 MAMA NON MAMA WHITE	CLICS00MNM00000000EU	€ 198,00		
		 FUMÉ	CLICS00FUM00000000EU	€ 198,00		
		 PIXEL	CLICS00PXL00000000EU	€ 198,00		
		 BLACK	CLICS00BLK00000000EU	€ 170,00		
		 WHITE	CLICS00WHT00000000EU	€ 170,00		
		 ORANGE	CLICS00ORG00000000EU	€ 170,00		
		 PURPLE	CLICS00PRP00000000EU	€ 170,00		

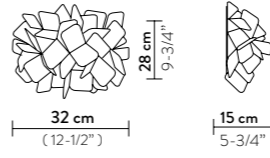
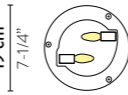
CLIZIA APPLIQUE design by Adriano Rachele

Compendium page 424
+ Clizia 10th Anniversary Catalogue

PRODUCT / PRODOTTO	DIMENSIONS / MISURE	COLOUR / COLORE	CODE / CODICE	PRICE VAT EXCL. / PREZZO IVA ESCL.
APPLIQUE Bulbs E14:  2 X 6W LED Filament Dimmable with: Dimmable bulbs Made of: Cristalflex® With: Magnetic Hanging System Weight: net Kg 0,6 - gross Kg 1,4 Package: 36 x 38 x h. 15 cm	 28 cm (9-3/4") 32 cm (12-1/2") 15 cm 5-3/4" LIGHT SOURCE:  19 cm 7-1/4"	 MAMA NON MAMA GOLD	CLIWM00GNM00000000EU	€ 190,00
		 MAMA NON MAMA BLACK	CLIWM00BNM00000000EU	€ 170,00
		 MAMA NON MAMA WHITE	CLIWM00MNM00000000EU	€ 170,00

CLIZIA ENTIRE COLLECTION

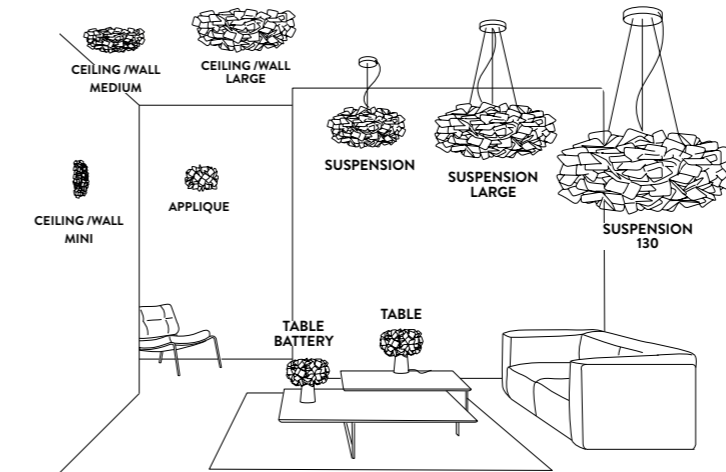

FINISHES



CLIZIA SUSPENSION by Adriano Rachele

Compendium page 146 / 152 / 156 / 150

+ Clizia 10th Anniversary Catalogue

PRODUCT / PRODOTTO	DIMENSIONS / MISURE	COLOUR / COLORE	CODE / CODICE	PRICE VAT EXCL. / IVA ESCL.
SUSPENSION 130 Bulbs E27: 15 X 12W LED Filament Dimmable with: Dimmable bulbs Made of: Polycarbonate Weight: net Kg 15 - gross Kg 30 Package: 150 x 150 x h. 64 cm		MAMA NON MAMA GOLD RED WIRE	CLISXXLGNM01R00000EU	€ 2.860,00
		MAMA NON MAMA GOLD TRSP. WIRE	CLISXXLGNM01T00000EU	€ 2.860,00
		MAMA NON MAMA BLACK BLACK WIRE	CLISXXLBNM01B00BLCEU	€ 2.430,00
		MAMA NON MAMA BLACK TRSP. WIRE	CLISXXLBNM01T00000EU	€ 2.430,00
		MAMA NON MAMA WHITE RED WIRE	CLISXXLMNM01R00000EU	€ 2.430,00
		MAMA NON MAMA WHITE TRSP. WIRE	CLISXXLMNM01T00000EU	€ 2.430,00
SUSPENSION LARGE Bulbs E27: 4 X 12W LED Filament Dimmable with: Dimmable bulbs Made of: Opalflex® / Cristalflex® Lentiflex® With: Magnetic Hanging System Weight: net Kg 2,94 - gross Kg 7,6 Package: 80 x 80 x h. 30 cm		MAMA NON MAMA GOLD RED WIRE	CLISL00GNM01R00000EU	€ 795,00
		MAMA NON MAMA GOLD TRSP. WIRE	CLISL00GNM01T00000EU	€ 795,00
		MAMA NON MAMA BLACK BLACK WIRE	CLISL00BNM01B00BLCEU	€ 675,00
		MAMA NON MAMA BLACK TRSP. WIRE	CLISL00BNM01T00000EU	€ 675,00
		MAMA NON MAMA WHITE RED WIRE	CLISL00MNM01R00000EU	€ 660,00
		MAMA NON MAMA WHITE TRSP. WIRE	CLISL00MNM01T00000EU	€ 660,00
		PIXEL RED WIRE	CLISL00PXL01R00000EU	€ 660,00
		PIXEL TRANSP. WIRE	CLISL00PXL01T00000EU	€ 660,00
		FUMÉ	CLISL00FUM01T00000EU	€ 630,00
		WHITE	CLISL00WHT01T00000EU	€ 550,00
SUSPENSION Bulbs E27: 2 X 12W LED Filament Dimmable with: Dimmable bulbs Made of: Opalflex® / Cristalflex® Lentiflex® With: Magnetic Hanging System Weight: net Kg 2 - gross Kg 2,7 Package: 55 x 57 x h. 26 cm		MAMA NON MAMA GOLD RED WIRE	CLISS00GNM01R00000EU	€ 399,00
		MAMA NON MAMA GOLD TRSP. WIRE	CLISS00GNM01T00000EU	€ 399,00
		MAMA NON MAMA BLACK BLACK WIRE	CLISS00BNM01B00BLCEU	€ 330,00
		MAMA NON MAMA BLACK TRSP. WIRE	CLISS00BNM01T00000EU	€ 330,00
		MAMA NON MAMA WHITE RED WIRE	CLISS00MNM01R00000EU	€ 330,00
		MAMA NON MAMA WHITE TRSP. WIRE	CLISS00MNM01T00000EU	€ 330,00
		PIXEL RED WIRE	CLISS00PXL01R00000EU	€ 330,00
		PIXEL TRANSP. WIRE	CLISS00PXL01T00000EU	€ 330,00
		FUMÉ	CLISS00FUM01T00000EU	€ 310,00
		WHITE	CLISS00WHT01T00000EU	€ 280,00
		ORANGE	CLISS00ORG01T00000EU	€ 280,00
		PURPLE	CLISS00PRP01T00000EU	€ 280,00
		BLUE	CLISS00BLU01T00000EU	€ 280,00

SUSPENSION CANOPY DETAILS

130: Ø 19 x 5 cm (Ø 7-1/2" x h. 2")
 LARGE: Ø 14 cm x h. 3 cm (Ø 5-1/2" x h. 1")
 MEDIUM: Ø 12 cm x h. 3,2 cm (Ø 4-3/4" x h. 1-1/4")

Canopy colour: white / Colore rosone: bianco

FUMÉ - WHITE - ORANGE - PURPLE
 Available also only with transparent cable
 Disponibile solo con cavo trasparente

CLIZIA SUSPENSION MAMA NON MAMA - GOLD
CLIZIA SUSPENSION MAMA NON MAMA - WHITE
CLIZIA SUSPENSION PIXEL

Red wrapped electric wire - Available also with transparent cable
 Cavo calzato rosso - Disponibile anche con cavo trasparente

CLIZIA SUSPENSION MAMA NON MAMA - BLACK

Black wrapped electric wire with black matte canopy
 Available also with transparent cable with white canopy

Cavo calzato nero con rosone nero opaco
 Disponibile con cavo elettrico trasparente con rosone bianco

6m. cable kit must be ordered with lamp purchase
 Kit Cavi da 6m da richiedere tassativamente in fase di ordine

Kit di installazione multipla su richiesta
 Multiple installation kit on request

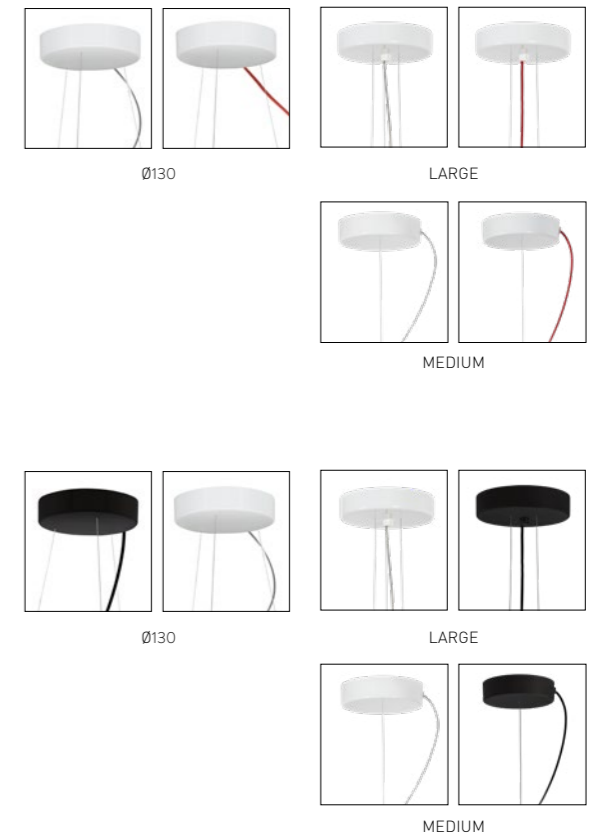

FINISHES



CLIZIA BATTERY

by Adriano Rachele

Compendium page 344 / 342
+ Clizia 10th Anniversary Catalogue

PRODUCT / PRODOTTO	DIMENSIONS / MISURE	COLOUR / COLORE	CODE / CODICE	PRICE VAT EXCL / IVA ESCL.
BATTERY LAMP LED: 1.3 W dimmable LED - 150 Lumen 2700 Kelvin - Rechargeable Li-ion Polymer Cell 3.7 Vdc 2500 mAh Charge 5 Vdc 1 A Battery duration: at max. intensity around 6,5 hours duration, at min. intensity around 60 hours duration With: USB/ DC plug included Made of: Cristalflex® or Lentiflex® Polycarbonate base Weight: net Kg 0,63 - gross Kg 1,2 Package: 29 x 28 x h. 26 cm		MAMA NON MAMA GOLD DARK BASE	CLIT000GNM000BDLBEU	€ 295,00
		MAMA NON MAMA GOLD LIGHT BASE	CLIT000GNM000BDWHBEU	€ 295,00
		MAMA NON MAMA BLACK	CLIT000BNM000BD000EU	€ 270,00
		MAMA NON MAMA WHITE	CLIT000MNM000BD000EU	€ 260,00
		FUMÉ	CLIT000FUM000BD000EU	€ 260,00
USB MULTICHARGER STATION 20 PORTS With: 20 USB, wire 1,50 m fan automatic heat dissipation Weight: net Kg 0,49 - gross Kg 0,53 Package: 15,5 x 15,5 x h. 7 cm			ACC00CHAP020_000	€ 195,00

CLIZIA TABLE

design by Adriano Rachele

Compendium page 348
+ Clizia 10th Anniversary Catalogue

PRODUCT / PRODOTTO	DIMENSIONS / MISURE	COLOUR / COLORE	CODE / CODICE	PRICE VAT EXCL / IVA ESCL.
TABLE LAMP Bulbs E14: 1X 6W LED Filament Made of: Lentiflex® / Cristalflex Fumé® Polycarbonate base With: Magnetic Hanging System Weight: net Kg 0,63 - gross Kg 1,2		MAMA NON MAMA GOLD DARK BASE	CLITS00GNM00000BLBEU	€ 220,00
		MAMA NON MAMA GOLD LIGHT BASE	CLITS00GNM00000WHBEU	€ 220,00
		MAMA NON MAMA BLACK	CLITS00BNM00000000EU	€ 198,00
		MAMA NON MAMA WHITE	CLITS00MNM000000000EU	€ 198,00
		FUMÉ	CLITS00FUM000000000EU	€ 210,00
		WHITE	CLITS00WHT000000000EU	€ 210,00
		ORANGE	CLITS00ORG000000000EU	€ 210,00
		PURPLE	CLITS00PRP000000000EU	€ 210,00
		BLACK	CLITS00BLK000000000EU	€ 210,00

FINISHES



CORDOBA

design by Daniel Libeskind

Compendium page 66

PRODUCT / PRODOTTO	DIMENSIONS / MISURE	COLOUR / COLORE	CODE / CODICE	PRICE VAT EXCL. / PREZZO IVA ESCL.
<p>SUSPENSION</p> <p>LED: 130W - 110 ~ 240 Vac / 24 Vdc 15.000 Lumen 2900 Kelvin - CRI > 90</p> <p>Dimmable with: PWM, 1-10 or Potentiometer</p> <p>Made of: Cristalflex®</p> <p>Weight: net Kg 6 - gross Kg 14</p> <p>Package: 120 x 80 x h.63 cm</p>		<input type="checkbox"/> WHITE	CRDSM00WHT06T00000EU	€ 3.200,00
<p>ADDITIONAL DIMMING SYSTEM DALI, BLUETOOTH, CASAMBI, TRIAC UPON REQUEST</p>				

CANOPY DETAILS



CORDOBA

28/25 cm x 13/10,4 cm x h. 5 cm
(11" x 5" x h 2")

6 m. cable kit standard
Kit Cavi da 6m standard

CORDOBA ENTIRE COLLECTION

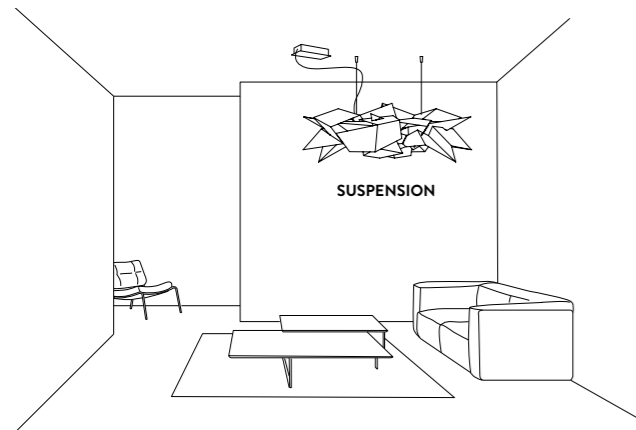



FINISHES



WHITE

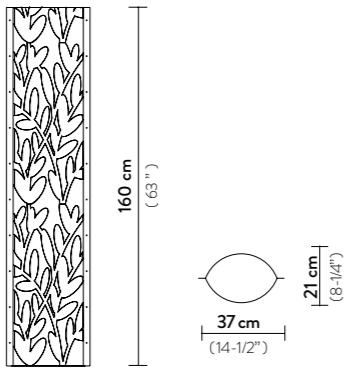

PRODUCT / PRODOTTO	DIMENSIONS / MISURE	COLOUR/COLORE	CODE / CODICE	PRICE VAT EXCL. / PREZZO IVA ESCL
FLOOR LAMP Bulbs E27: 3 X 12W LED Filament Dimmable with: Dimmable bulbs Made of: Opalflex® With: Dimmer - Aluminium profiles Weight: net Kg 2,80 - gross Kg 6,00 Package: 37 x 28 x h. 168 cm		<input type="checkbox"/> HYPERWHITE	TUBFXL0DFN00000000EU	€ 490,00
TABLE LAMP Bulbs E14: 1 X 6W LED Filament Made of: Opalflex® Weight: net Kg 0,40 - gross Kg 0,70 Package: 26 x 6 x h. 43 cm		<input type="checkbox"/> HYPERWHITE	TUBTS00DFN00000000EU	€ 130,00

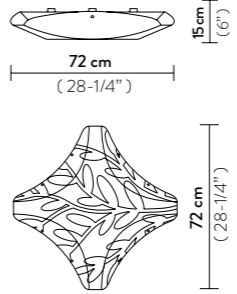
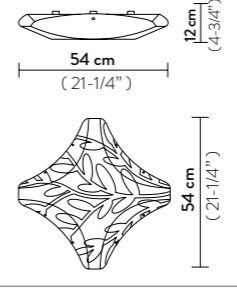
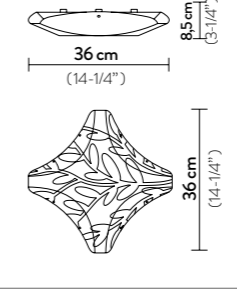
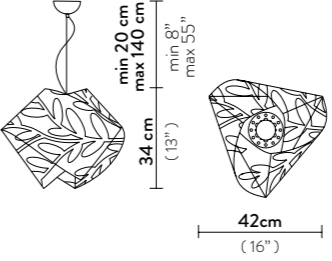
PRODUCT / PRODOTTO	DIMENSIONS / MISURE	COLOUR/COLORE	CODE / CODICE	PRICE VAT EXCL. / PREZZO IVA ESCL
CEILING WALL LAMP LARGE Bulbs E27: 4 X 12W LED Filament Dimmable with: Dimmable bulbs Made of: Opalflex® With: MagneticSystem® Weight: net Kg 3,00 - gross Kg 5,50 Package: 80 x 80 x h. 25 cm		<input type="checkbox"/> HYPERWHITE	DAFCL00WHT00000000EU	€ 320,00
CEILING WALL LAMP MEDIUM Bulbs E27: 3 X 12W LED Filament Dimmable with: Dimmable bulbs Made of: Opalflex® With: MagneticSystem® Weight: net Kg 2,00 - gross Kg 3,00 Package: 54,5 x 14 x h. 56 cm		<input type="checkbox"/> HYPERWHITE	DAFCM00WHT00000000EU	€ 220,00
CEILING WALL LAMP SMALL Bulbs E27: 2 X 12W LED Filament Dimmable with: Dimmable bulbs Made of: Opalflex® With: MagneticSystem® Weight: net Kg 0,60 - gross Kg 1,00 Package: 39 x 36 x h. 9,5 cm		<input type="checkbox"/> HYPERWHITE	DAFCS00WHT00000000EU	€ 160,00
SUSPENSION GEMMY DAFNE Bulbs E27: 1 X 12W LED Filament Dimmable with: Dimmable bulbs Made of: Opalflex® Weight: net Kg 1,10 - gross Kg 2,00 Package: 41 x 41 x h. 41 cm		<input type="checkbox"/> HYPERWHITE	GEMSM00DFN01T00000EU	€ 190,00

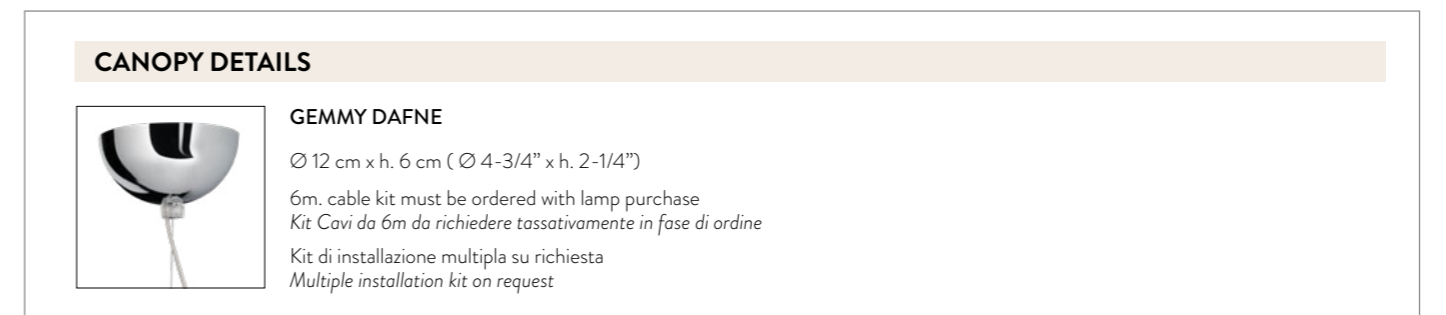
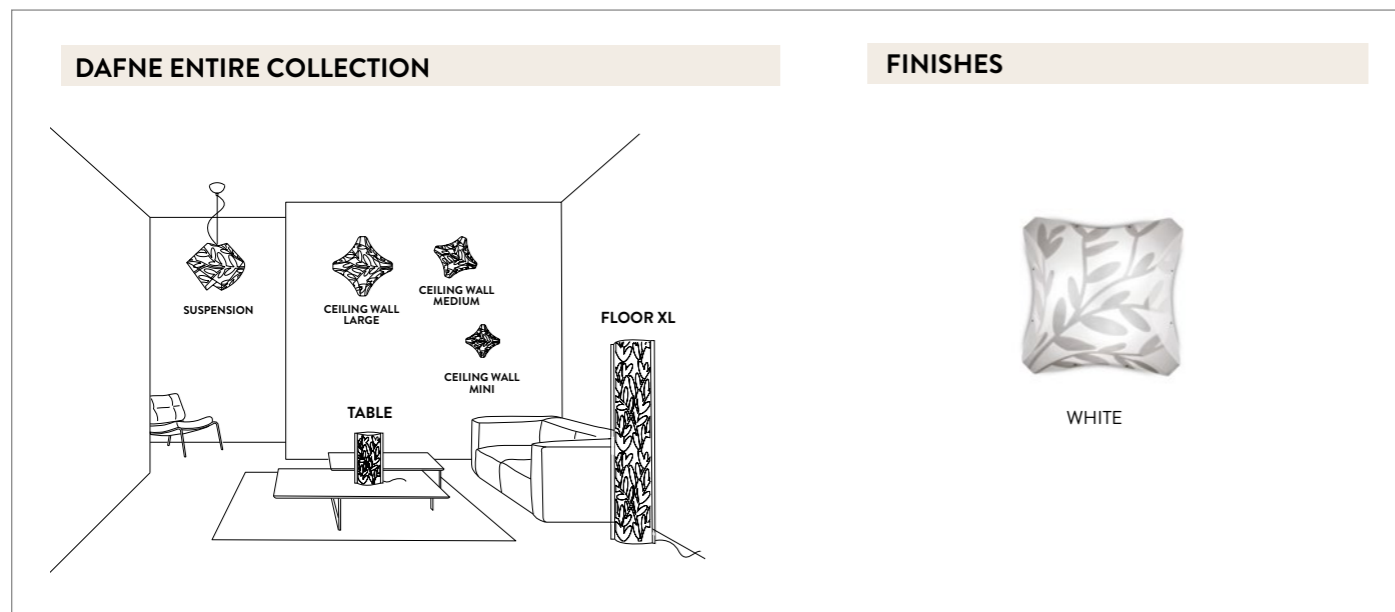

DIAMOND

design by Paolucci, Statera

Compendium page 498 / 376

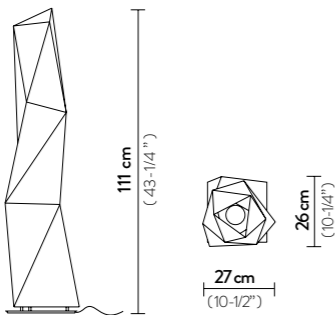
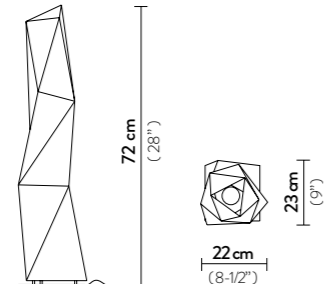
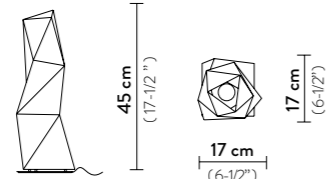
PRODUCT / PRODOTTO	DIMENSIONS / MISURE	COLOUR / COLORE	CODE / CODICE	PRICE VAT EXCL. / PREZZO IVA ESCL.
FLOOR LARGE Bulbs E27: 1 X 12W LED Filament Made of: Opalflex® With: Aluminium base Weight: net Kg 2,56 - gross Kg 3,8 Package: 33 x 28 x h. 121 cm		<input type="checkbox"/> WHITE	DIAFL00WHT00000000EU	€ 250,00
FLOOR MEDIUM Bulbs E27: 1 X 12W LED Filament Made of: Opalflex® With: Aluminium base Weight: net Kg 1,29 - gross Kg 1,63 Package: 24 x 24 x h. 75 cm		<input type="checkbox"/> WHITE	DIATM00WHT00000000EU	€ 190,00
TABLE SMALL Bulbs E14: 1 X 6W LED Filament Made of: Opalflex® With: Aluminium base Weight: net Kg 0,58 - gross Kg 0,6 Package: 21 x 22 x h. 47 cm		<input type="checkbox"/> WHITE	DIATS00WHT00000000EU	€ 140,00

DIAMOND ENTIRE COLLECTION

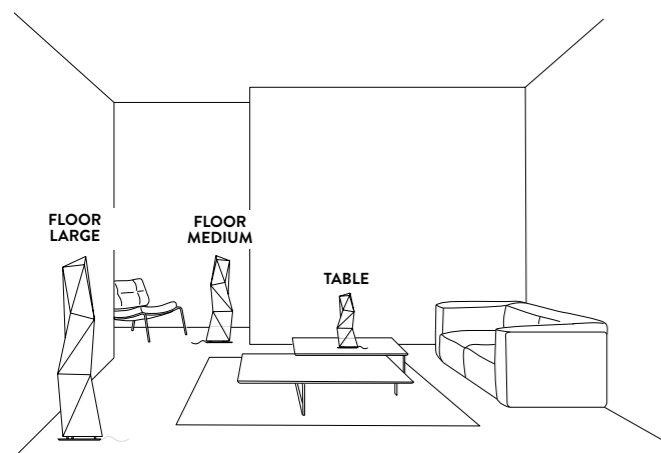

FINISHES



WHITE



PRODUCT / PRODOTTO	DIMENSIONS / MISURE	COLOUR/COLORE	CODE / CODICE	PRICE VAT EXCL. / PREZZO IVA ESCL.
SUSPENSION Bulbs E27: 4 X 12W LED Filament Dimmable with: Dimmable bulbs Made of: Lentiflex® With: MagneticSystem® Weight: net Kg 4,5 - gross Kg 5,5 Package: 64 x 62 x h. 34 cm		<input type="checkbox"/> WHITE	DRUSM00WHT01T000000EU	€ 550,00
		<input checked="" type="checkbox"/> VELVET	DRUSM00VLV01T000000EU	€ 590,00
CEILING / WALL Bulbs E27: 4 X 12W LED Filament Dimmable with: Dimmable bulbs Made of: Lentiflex® With: MagneticSystem® Weight: net Kg 2,1 - gross Kg 5 Package: 64 x 65 x h. 25 cm		<input type="checkbox"/> WHITE	DRUCM00WHT000000000EU	€ 410,00
		<input checked="" type="checkbox"/> VELVET	DRUCM00VLV000000000EU	€ 450,00

CANOPY DETAILS



DRUSA

Ø 12 cm x h. 3,2 cm (Ø4-3/4" x h 1-1/4")

6m. cable kit must be ordered with lamp purchase
 Kit Cavi da 6m da richiedere tassativamente in fase di ordine

Kit di installazione multipla su richiesta
 Multiple installation kit on request

DRUSA ENTIRE COLLECTION

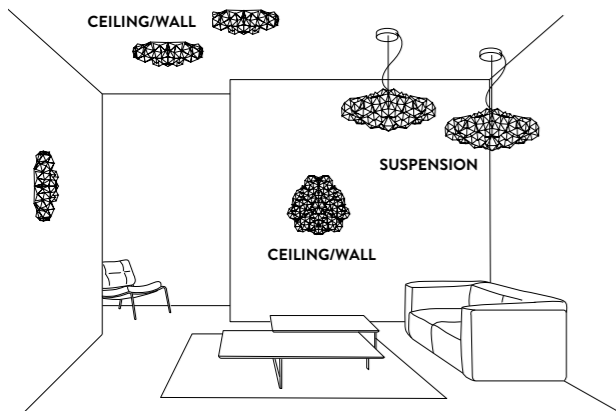

FINISHES



WHITE



VELVET

PRODUCT / PRODOTTO	DIMENSIONS / MISURE	COLOUR/COLORE	CODE / CODICE	PRICE VAT EXCL. / PREZZO IVA ESCL.
FLOOR LAMP Bulbs E27: 3 X 12W LED Filament Dimmable with: Dimmable bulbs Made of: Opalflex® With: Aluminium Profile - Dimmer Weight: net Kg 2,80 - gross Kg 6,00 Package: 37 x 28 x h. 168cm		<input checked="" type="checkbox"/> ECSTACITY DECOR	TUBFXLOECS000000000EU	€ 630,00

ECSTACITY ENTIRE COLLECTION

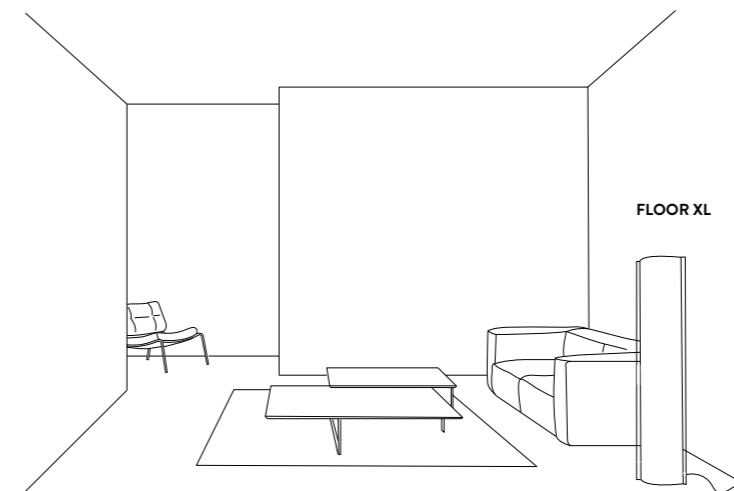

FINISHES



ECSTACITY DECOR

PRODUCT / PRODOTTO	DIMENSIONS / MISURE	COLOUR/COLORE	CODE / CODICE	PRICE VAT EXCL. / PREZZO IVA ESCL.
SUSPENSION LARGE Bulbs E27: 5 X 12W LED Filament Dimmable with: Dimmable bulbs Made of: Lentiflex® With: Magnetic System® Weight: net Kg 3 - gross Kg 5,8 Package: 62 x 64 x h. 34 cm	<p>LIGHT SOURCE: BOTTOM VIEW</p>	<input type="checkbox"/> PRISMA	FABSL00PRS01T000000EU	€ 580,00
SUSPENSION Bulbs E27: 3 X 12W LED Filament Dimmable with: Dimmable bulbs Made of: Lentiflex® With: Magnetic System® Weight: net Kg 1,5 - gross Kg 3,15 Package: 57 x 58 x h. 30 cm	<p>LIGHT SOURCE: BOTTOM VIEW</p>	<input type="checkbox"/> PRISMA	FABSM00PRS01T000000EU	€ 410,00

PRODUCT / PRODOTTO	DIMENSIONS / MISURE	COLOUR/COLORE	CODE / CODICE	PRICE VAT EXCL. / PREZZO IVA ESCL.
CEILING/WALL LARGE Bulbs E27: 5 X 12W LED Filament Dimmable with: Dimmable bulbs Made of: Lentiflex® With: Magnetic System® Weight: net Kg 3 - gross Kg 5,8 Package: 62 x 64 x h. 34 cm	<p>LIGHT SOURCE: BOTTOM VIEW</p>	<input type="checkbox"/> PRISMA	FABCL00PRS000000000EU	€ 520,00
CEILING/WALL Bulbs E27: 3 X 12W LED Filament Dimmable with: Dimmable bulbs Made of: Lentiflex® With: Magnetic System® Weight: net Kg 1,5 - gross Kg 3,15 Package: 57 x 58 x h. 30 cm	<p>LIGHT SOURCE: BOTTOM VIEW</p>	<input type="checkbox"/> PRISMA	FABCM00PRS000000000EU	€ 370,00

CANOPY DETAILS



LARGE VERSION SMALL VERSION

FABULA SUSPENSION

LARGE: Ø 14 cm x h. 3 cm (Ø 5-1/2" x h. 1")

SMALL: Ø 12 cm x h. 3,2 cm (Ø 4-3/4" x h. 1-1/4")

6m. cable kit must be ordered with lamp purchase
 Kit Cavi da 6m da richiedere tassativamente in fase di ordine

Kit di installazione multipla su richiesta
 Multiple installation kit on request

FABULA ENTIRE COLLECTION

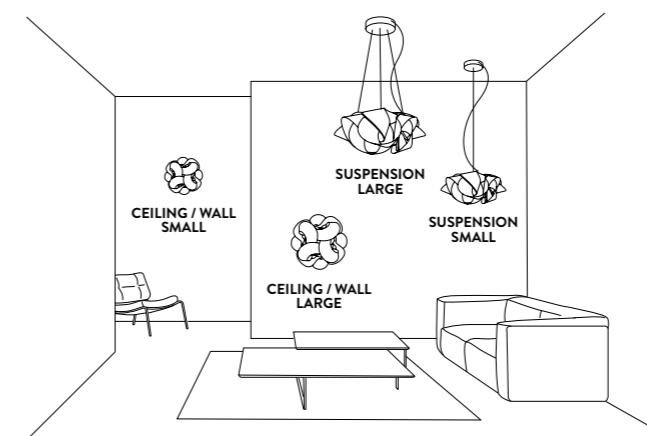

FINISHES

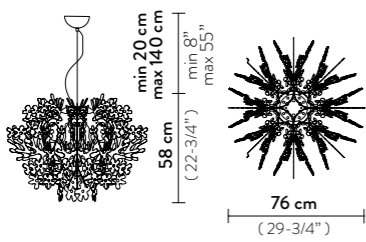
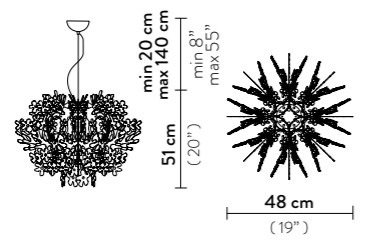
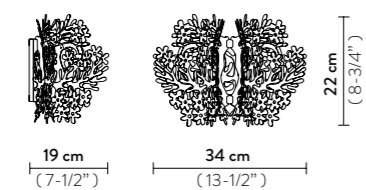

PRISMA

PRODUCT / PRODOTTO	DIMENSIONS / MISURE	COLOUR/COLORE	CODE / CODICE	PRICE VAT EXCL. / PREZZO IVA ESCL.
SUSPENSION Bulbs E27: 1X 12W LED Filament Dimmable with: Dimmable bulbs Made of: Opalflex® / Cristalflex® Weight: net Kg 2,5 - gross Kg 5 Package: 48 x 33 x h. 59 cm		<input type="checkbox"/> WHITE	FIOSM00WHT01T000000EU	€ 430,00
		<input type="checkbox"/> SILVER	FIOSM00SLV01T000000EU	€ 430,00
SUSPENSION MINI Bulbs E27: 1X 12W LED Filament Dimmable with: Dimmable bulbs Made of: Opalflex® / Cristalflex® Goldflex® / Steelflex® / Copperflex® Weight: net Kg 1,3 - gross Kg 2,1 Package: 33 x 34 x h. 47 cm		<input type="checkbox"/> WHITE	FIOSM00WHT01T000000EU	€ 290,00
		<input type="checkbox"/> SILVER	FIOSM00SLV01T000000EU	€ 430,00
APPLIQUE MINI Bulbs E14: 1X 6W LED Filament Dimmable with: Dimmable bulbs Made of: Opalflex® / Cristalflex® With: Stainless Steel Support Weight: net Kg 0,5 - gross Kg 1,3 Package: 29 x 28 x h. 36 cm		<input type="checkbox"/> WHITE	FIOWS00WHT000000000EU	€ 198,00
		<input type="checkbox"/> SILVER	FIOWS00SLV000000000EU	€ 198,00

CANOPY DETAILS



FIORELLA SUSPENSION

LARGE: Ø 12 cm x h. 6 cm (Ø 4-3/4" x h. 2-1/4")

MINI: Ø 10 cm x h. 5,5 cm (Ø 4" x h. 2")

6m. cable kit must be ordered with lamp purchase
 Kit Cavi da 6m da richiedere tassativamente in fase di ordine

Kit di installazione multipla su richiesta
 Multiple installation kit on request

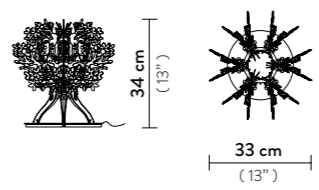
PRODUCT / PRODOTTO	DIMENSIONS / MISURE	COLOUR/COLORE	CODE / CODICE	PRICE VAT EXCL. / PREZZO IVA ESCL.
FIORELLINA TABLE Bulbs E14: 1X 6W LED Filament Made of: Opalflex® / Cristalflex® Goldflex® / Steelflex® / Copperflex® With: Base matching colour Weight: net Kg 1 - gross Kg 1,5 Package: 39 x 34 x h. 38 cm		<input type="checkbox"/> WHITE	FIOTS00WHT000000000EU	€ 230,00
		<input checked="" type="checkbox"/> GOLD	FIOTS00GLD000000000EU	€ 330,00
		<input checked="" type="checkbox"/> SILVER	FIOTS00SLV000000000EU	€ 330,00
		<input checked="" type="checkbox"/> COPPER	FIOTS00CPP000000000EU	€ 330,00
		<input type="checkbox"/> SILVER	FIOTS00SLV000000000EU	€ 330,00

FIORELLA ENTIRE COLLECTION

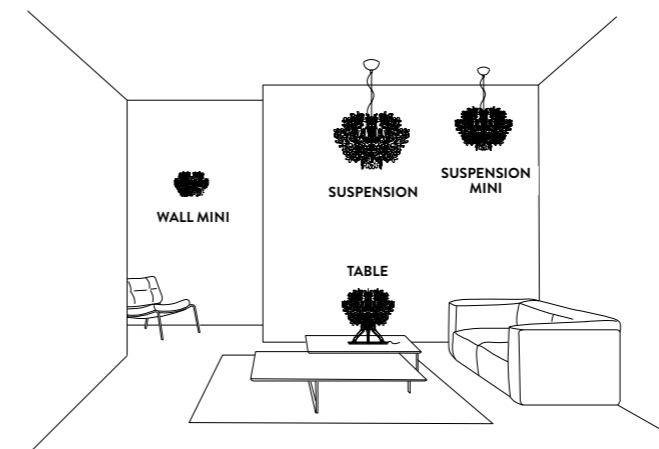

FINISHES

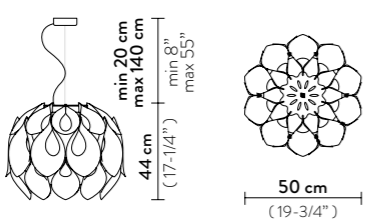
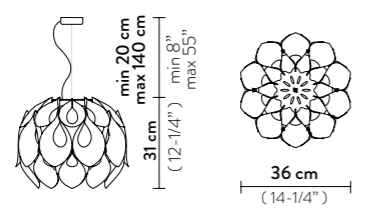

PRODUCT / PRODOTTO	DIMENSIONS / MISURE	COLOUR / COLORE	CODE / CODICE	PRICE VAT EXCL. / PREZZO IVA ESCL.
SUSPENSION MEDIUM Bulbs E27: 3 X 12W LED Filament Dimmable with: Dimmable bulbs Made of: Lentiflex® - Methacrylate Goldflex® / Steelflex® / Copperflex® With: Magnetic System® Hand- finished Sphere Weight: net Kg 3 - gross Kg 4,5 Package: 54 x 46 x h. 44 cm		<input type="checkbox"/> WHITE	FLOSM00WHT01T000000EU	€ 580,00
		<input checked="" type="checkbox"/> GOLD	FLOSM00GLD01T000000EU	€ 730,00
		<input type="checkbox"/> SILVER	FLOSM00SLV01T000000EU	€ 730,00
		<input type="checkbox"/> COPPER	FLOSM00CPP01T000000EU	€ 730,00
		<input type="checkbox"/> PEWTER	FLOSM00PWT01T000000EU	€ 730,00
SUSPENSION SMALL Bulbs E27: 1 X 12W LED Filament Dimmable with: Dimmable bulbs Made of: Lentiflex® - Methacrylate Goldflex® / Steelflex® / Copperflex® With: Magnetic System® Hand- finished Sphere Weight: net Kg 1 - gross Kg 2,4 Package: 40 x 40 x h. 30 cm		<input type="checkbox"/> WHITE	FLOSS00WHT01T000000EU	€ 350,00
		<input checked="" type="checkbox"/> GOLD	FLOSS00GLD01T000000EU	€ 460,00
		<input type="checkbox"/> SILVER	FLOSS00SLV01T000000EU	€ 460,00
		<input type="checkbox"/> COPPER	FLOSS00CPP01T000000EU	€ 460,00
		<input type="checkbox"/> PEWTER	FLOSS00PWT01T000000EU	€ 460,00

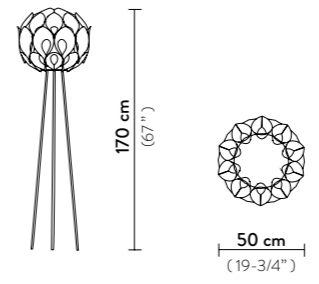
PRODUCT / PRODOTTO	DIMENSIONS / MISURE	COLOUR / COLORE	CODE / CODICE	PRICE VAT EXCL. / PREZZO IVA ESCL.
FLOOR Bulbs E27: 3 X 12W LED Filament Dimmable with: Dimmable bulbs Made of: Methacrylate / Lentiflex® Goldflex® / Steelflex® / Copperflex® With: Magnetic System® - Dimmer Hand- finished Sphere Weight: net Kg 5 - gross Kg 8,6 Package: A 55 x 56 x h.45 cm - Kg 4,6 B 21 x 152x h.12 cm - Kg 4		<input type="checkbox"/> WHITE	FLOFM00WHT0000000000EU	€ 860,00
		<input checked="" type="checkbox"/> GOLD	FLOFM00GLD0000000000EU	€ 1.090,00
		<input type="checkbox"/> SILVER	FLOFM00SLV0000000000EU	€ 1.090,00
		<input type="checkbox"/> COPPER	FLOFM00CPP0000000000EU	€ 1.090,00
		<input type="checkbox"/> PEWTER	FLOFM00PWT0000000000EU	€ 1.090,00

CANOPY DETAILS



WHITE VERSION



METALLIZED VERSION

FLORA

Ø 12 cm x h. 3,2 cm (Ø 4-3/4" x h. 1-1/4")

 6m. cable kit must be ordered with lamp purchase
 Kit Cavi da 6m da richiedere tassativamente in fase di ordine

 Kit di installazione multipla su richiesta
 Multiple installation kit on request

FLORA ENTIRE COLLECTION

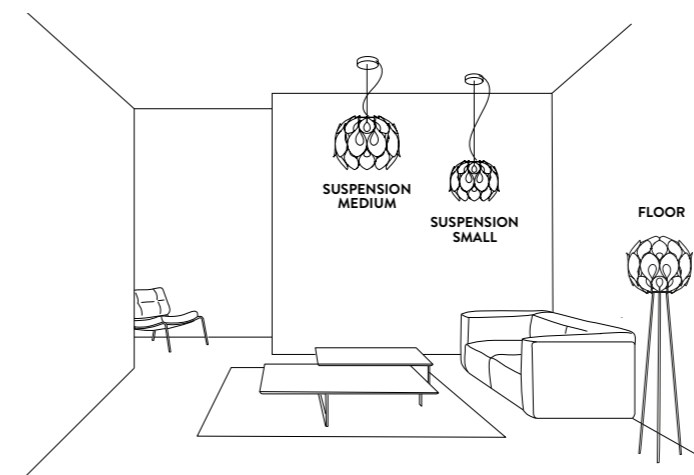

FINISHES



WHITE

GOLD

SILVER



COPPER

PEWTER

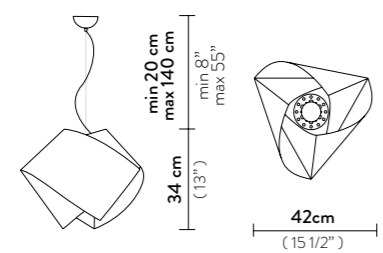
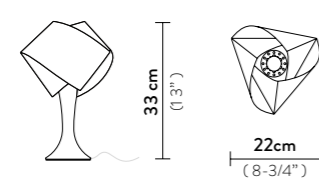
PRODUCT / PRODOTTO	DIMENSIONS / MISURE	COLOUR / COLORE	CODE / CODICE	PRICE VAT EXCL. / PREZZO IVA ESCL.
SUSPENSION Bulbs E27: 1 X 12W LED Filament Dimmable with: Dimmable bulbs Made of: Opalflex® Weight: net Kg 1,10 - gross Kg 2 Package: 41 x 41 x h. 41cm		ARLECCHINO	GEMSM00ARL01T000000EU	€ 190,00
		MULTICOLOR	GEMSM00MCL01T000000EU	€ 190,00
		GOLD	GEMSM00GLD01T000000EU	€ 190,00
		ORANGE	GEMSM00ORG01T000000EU	€ 190,00
		YELLOW	GEMSM00YLW01T000000EU	€ 190,00
		GREEN	GEMSM00GRN01T000000EU	€ 190,00
TABLE LAMP S Bulbs E14: 1 X 6W LED Filament Made of: Opalflex® With: White steel base Weight: net Kg 0,50 - gross Kg 0,70 Package: 25 x 23,5 x h. 35 cm		ARLECCHINO	GEMTS00ARL0000000000EU	€ 180,00
		MULTICOLOR	GEMTS00MCL0000000000EU	€ 180,00
		ORANGE	GEMTS00ORG0000000000EU	€ 180,00
		YELLOW	GEMTS00YLW0000000000EU	€ 180,00
		GREEN	GEMTS00GRN0000000000EU	€ 180,00
		BLUE	GEMTS00BLU0000000000EU	€ 180,00

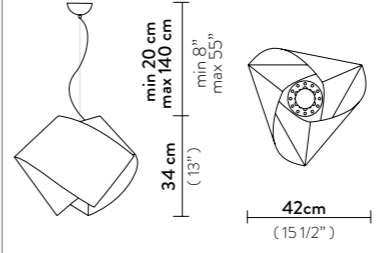
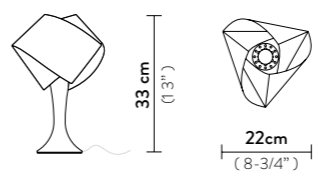
PRODUCT / PRODOTTO	DIMENSIONS / MISURE	COLOUR / COLORE	CODE / CODICE	PRICE VAT EXCL. / PREZZO IVA ESCL.
SUSPENSION Bulbs E27: 1 X 12W LED Filament Dimmable with: Dimmable bulbs Made of: Lentiflex® Weight: net Kg 1,10 - gross Kg 2 Package: 41 x 41 x h. 41cm		PRISMA	GEMSM00PRSO1T000000EU	€ 210,00
		AMBER	GEMSM00AMB01T000000EU	€ 210,00
		AMETHYST	GEMSM00AMT01T000000EU	€ 210,00
		EMERALD	GEMSM00EMD01T000000EU	€ 210,00
		GOLD	GEMSM00PRG01T000000EU	€ 210,00
		TABLE LAMP S Bulbs E14: 1 X 6W LED Filament Made of: Lentiflex® With: White steel base Weight: net Kg 0,50 - gross Kg 0,70 Package: 25 x 23,5 x h. 35 cm		PRISMA
AMBER	GEMTS00AMB0000000000EU			€ 200,00
AMETHYST	GEMTS00AMT0000000000EU			€ 200,00
EMERALD	GEMTS00EMD0000000000EU			€ 200,00
GOLD	GEMTS00PRG0000000000EU			€ 200,00

GEMMY ENTIRE COLLECTION

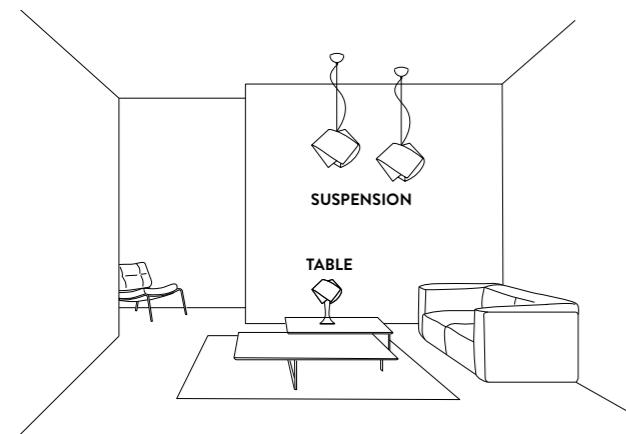

CANOPY DETAILS



GEMMY SUSPENSION
 Ø10 cm x h. 5,5 cm (Ø 4" x h. 2")
 6m. cable kit must be ordered with lamp purchase
 Kit Cavi da 6m da richiedere tassativamente in fase di ordine
 Kit di installazione multipla su richiesta
 Multiple installation kit on request

FINISHES

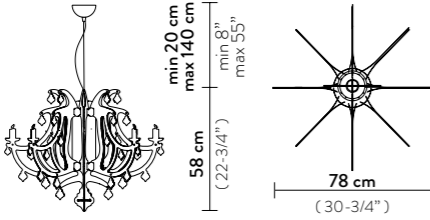
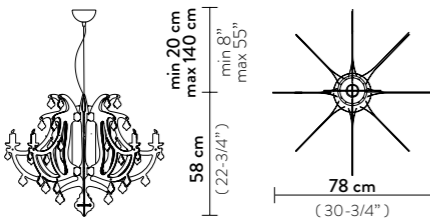

PRODUCT / PRODOTTO	DIMENSIONS / MISURE	COLOUR / COLORE	CODE / CODICE	PRICE VAT EXCL. / PREZZO IVA ESCL.
SUSPENSION PRISMA Bulbs E27: 1 X 12W LED Filament Dimmable with: Dimmable bulbs Made of: Lentiflex® With: Iridescent bulb screen MagneticSystem® Weight: net Kg 2 - gross Kg 4,5 Package: 48 x 33 x h. 59 cm		<input type="checkbox"/> PRISMA	GINSM00PRS01T00000EU	€ 550,00
SUSPENSION Bulbs E27: 1 X 12W LED Filament Dimmable with: Dimmable bulbs Made of: Opalflex® - Cristalflex® Steelflex® Weight: net Kg 2 - gross Kg 4,5 Package: 48 x 33 x h. 59 cm		<input type="checkbox"/> WHITE <input type="checkbox"/> BLACK <input type="checkbox"/> SILVER <input type="checkbox"/> GOLD	GINSM00WHT01T00000EU GINSM00BLK01T00000EU GINSM00SLV01T00000EU GINSM00GLD01T00000EU	€ 450,00 € 450,00 € 620,00 € 620,00

CANOPY DETAILS



GINETTA

Ø 12 cm x h. 6 cm (Ø 4-3/4" x h. 2-1/4")
 6m. cable kit must be ordered with lamp purchase
 Kit Cavi da 6m da richiedere tassativamente in fase di ordine
 Kit di installazione multipla su richiesta
 Multiple installation kit on request

GINETTA ENTIRE COLLECTION

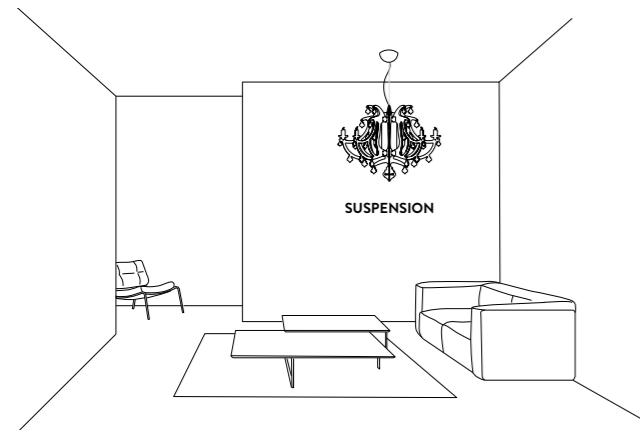

FINISHES

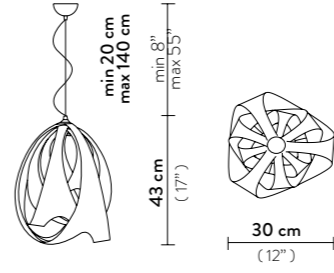

PRODUCT / PRODOTTO	DIMENSIONS / MISURE	COLOUR / COLORE	CODE / CODICE	PRICE VAT EXCL. / PREZZO IVA ESCL.
SUSPENSION Bulbs E27: 1 X 12W LED Filament Dimmable with: Dimmable bulbs Made of: Lentiflex® - Opalflex® Weight: net Kg 0,80 - gross Kg 2 (Opalflex®) net Kg 1,60 - gross Kg 2 (Lentiflex®) Package: 34 x 34 x h. 49,5 cm		<input type="checkbox"/> AQUA <input type="checkbox"/> FIRE <input type="checkbox"/> OPAL <input type="checkbox"/> TETRA <input type="checkbox"/> JET <input type="checkbox"/> SNOW <input type="checkbox"/> PRISMA	GOCSM00AQA01T00000EU GOCSM00WHO01T00000EU GOCSM00WHB01T00000EU GOCSM00TTR01T00000EU GOCSM00BLK01T00000EU GOCSM00WHT01T00000EU GOCSM00PRS01T00000EU	€ 190,00 € 190,00 € 190,00 € 190,00 € 190,00 € 190,00 € 220,00

CANOPY DETAILS



GOCCIA

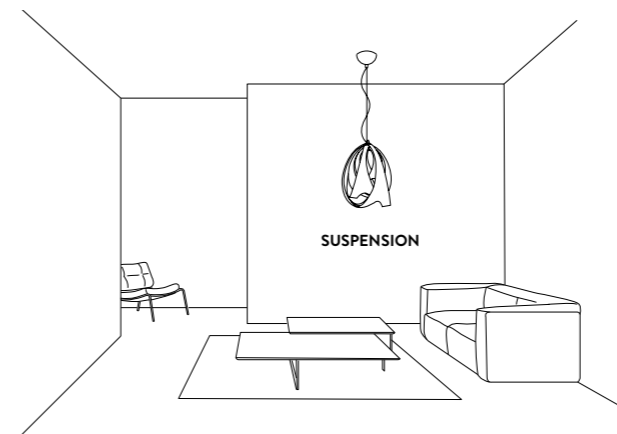

Ø 10 cm x h. 5,5 cm (Ø 4" x h. 2")
 6m. cable kit must be ordered with lamp purchase
 Kit Cavi da 6m da richiedere tassativamente in fase di ordine
 Kit di installazione multipla su richiesta
 Multiple installation kit on request

GOCCIA ENTIRE COLLECTION



FINISHES

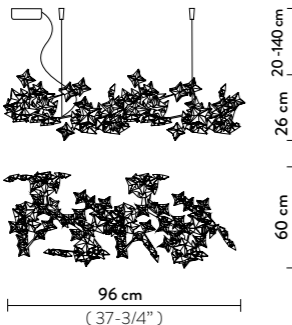

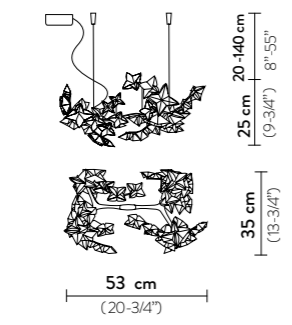
PRODUCT / PRODOTTO	DIMENSIONS / MISURE	COLOUR / COLORE	CODE / CODICE	PRICE VAT EXCL. / PREZZO IVA ESCL.
SUSPENSION LARGE Bulbs:  10 X 5W G9 LED Dimmable Made of: Lentiflex® / Polycarbonate / Stainless Steel With: Dimmable Bulbs Included Red wrapped electric wire Available also with transparent cable Weight: net Kg 2,7 - gross Kg 7,05 Package: 98 x 51 x h. 36 cm	 <p>20-140 cm (8"-55") 26 cm (10-1/4") 60 cm (23-1/2") 96 cm (37-3/4")</p>	PRISMA RED WIRE	HANSL00PRS01R00000EU	€ 1.100,00
		PRISMA TRSP WIRE	HANSL00PRS01T00000EU	€ 1.100,00
SUSPENSION Bulbs:  5 X 5W G9 LED Dimmable Made of: Lentiflex® / Polycarbonate / Stainless Steel With: Dimmable Bulbs Included Red wrapped electric wire Available also with transparent cable Weight: net Kg 2 - gross Kg 3,9 Package: 61 x 46 x h. 34 cm	 <p>20-140 cm (8"-55") 25 cm (9-3/4") 35 cm (13-3/4") 53 cm (20-3/4")</p>	PRISMA RED WIRE	HANSS00PRS01RG9000EU	€ 610,00
		PRISMA TRSP WIRE	HANSS00PRS01TG9000EU	€ 610,00

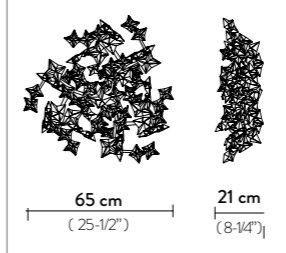
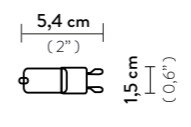
PRODUCT / PRODOTTO	DIMENSIONS / MISURE	COLOUR / COLORE	CODE / CODICE	PRICE VAT EXCL. / PREZZO IVA ESCL.
CEILING / WALL Bulbs:  7 X 5W G9 LED Dimmable Made of: Lentiflex® / Polycarbonate / Stainless Steel With: Dimmable Bulbs Included Weight: net Kg 1,7 - gross Kg 2,75 Package: 65,5 x 64 x h. 25 cm	 <p>65 cm (25-1/2") 21 cm (8-1/4")</p>	PRISMA	HANCM00PRS000G9000EU	€ 770,00
BULB DIMENSIONS:	 <p>5,4 cm (2") 1,5 cm (0,6")</p>			

CANOPY DETAILS



HANAMI

Ø 12 cm x h. 3,2 cm (Ø 4-3/4" x h. 1-1/4")

Red wrapped electric wire - Available also with transparent cable
Cavo calzato rosso - Disponibile anche con cavo trasparente

6m. cable kit must be ordered with lamp purchase
Kit Cavi da 6m da richiedere tassativamente in fase di ordine

HANAMI ENTIRE COLLECTION

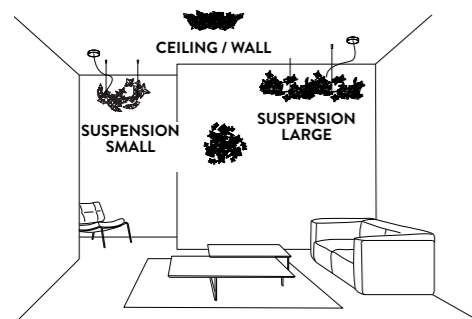

FINISHES



PRISMA
RED WIRE

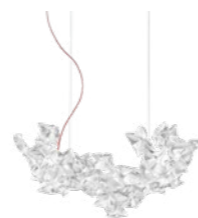

PRISMA
TRANSP. WIRE

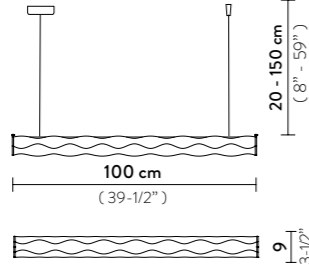
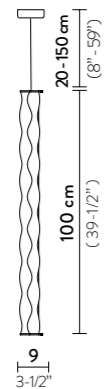
PRODUCT / PRODOTTO	DIMENSIONS / MISURE	COLOUR/COLORE	CODE / CODICE	PRICE VAT EXCL. / PREZZO IVA ESCL.
SUSPENSION LED: 25W - 100-240Vac/24Vdc 3.500 lumen - 3000 Kelvin (4000 Kelvin upon request) Dimmable with: PWM, 0-10 Made of: Lentiflex® Weight: net Kg 1,35 - gross Kg 2,20 Package: 114 x 16 x h. 16 cm		<input type="checkbox"/> PRISMA	HUGS000PRS01THR000EU	€ 530,00
		<input type="checkbox"/> WHITE	HUGS000WHT01THR000EU	€ 530,00
ADDITIONAL DIMMING SYSTEM DALI, BLUETOOTH, CASAMBI, TRIAC, UPON REQUEST				
SUSPENSION VERTICAL LED: 25W - 100-240Vac/24Vdc 3.500 lumen - 3000 Kelvin (4000 Kelvin upon request) Dimmable with: PWM, 0-10 Made of: Lentiflex® Weight: net Kg 1,35 - gross Kg 2,20 Package: 114 x 16 x h. 16 cm		<input type="checkbox"/> PRISMA	HUGS000PRS01TVT000EU	€ 530,00
		<input type="checkbox"/> WHITE	HUGS000WHT01TVT000EU	€ 530,00
ADDITIONAL DIMMING SYSTEM DALI, BLUETOOTH, CASAMBI, TRIAC, UPON REQUEST				

CANOPY DETAILS



HUGO - HUGO VERTICAL

Ø 14 cm x h. 4,5 cm (Ø 5-1/2" x h. 1-3/4")
 6m. cable kit must be ordered with lamp purchase
 Kit Cavi da 6m da richiedere tassativamente in fase di ordine

HUGO ENTIRE COLLECTION

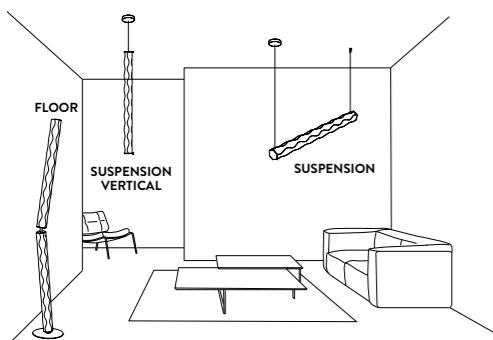

FINISHES

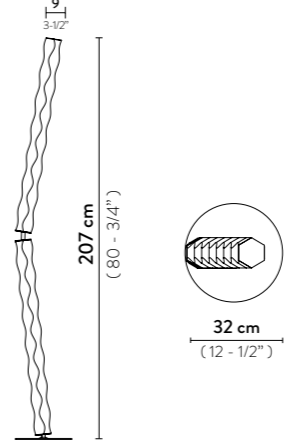

PRODUCT / PRODOTTO	DIMENSIONS / MISURE	COLOUR/COLORE	CODE / CODICE	PRICE VAT EXCL. / PREZZO IVA ESCL.
FLOOR LED: 40W -100~240Vac/24Vdc 7.000 lumen - 3000 Kelvin - Dimmable Made of: Lentiflex® - Stainless steel With: Integrated Dimmer Weight: net Kg 6,2 - gross Kg 8,4 Package: A 114 x 16 x h. 16 cm - Kg 2,10 B 114 x 16 x h. 16 cm - Kg 2,65 C 47 x 47 x h. 7 cm - Kg 3,65		<input type="checkbox"/> PRISMA	HUGFM00PRS00000000EU	€ 1.300,00
		ADDITIONAL DIMMING SYSTEM DALI, BLUETOOTH, CASAMBI, TRIAC, UPON REQUEST		

HUGO ENTIRE COLLECTION

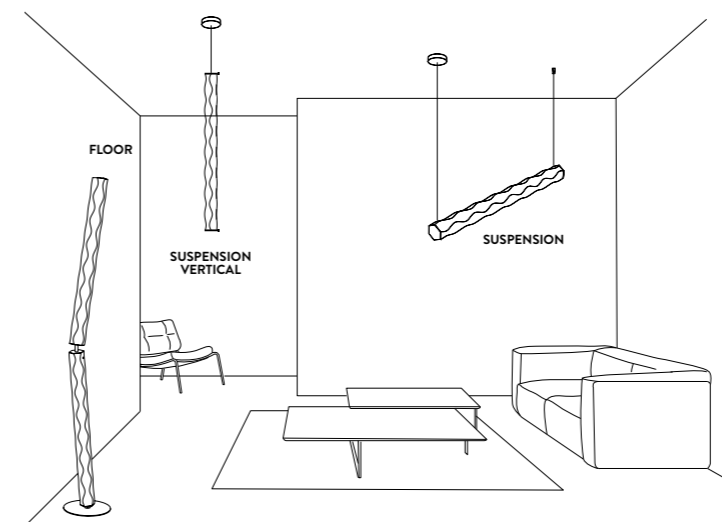

FINISHES



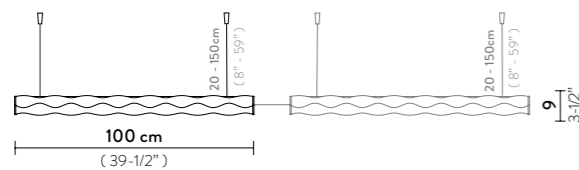

1 X HUGO MAIN
electrified module
CE IP 20

HUGO SIDE
up to 6 pieces
CE IP 20

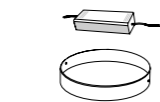

1 X CEILING ROSE
AND POWER SUPPLY
(variable sizes)



CONNECTION CABLES
30 cm (11-3/4")
up to 6 pieces

PRODUCT / PRODOTTO	DIMENSIONS / MISURE	COLOUR / COLORE	CODE / CODICE	PRICE VAT EXCL. PREZZO IVA ESCL.
ARCHITECTURAL SYSTEM 2 LED: 40W - 100-240Vac/24Vdc 7.000 lumen - 3000 Kelvin (4000 Kelvin upon request) Dimmable with: PWM, 0-10 Made of: Lentiflex® Weight: net Kg 2,6 - gross Kg 4,4 Package: A 114 x 16 x h 16 cm (X2) B 44 x 26 x 6,5 cm		<input type="checkbox"/> PRISMA	HUGSSS2PRS01TAR000EU	€ 1.250,00
		<input type="checkbox"/> WHITE	HUGSSS2WHT01TAR000EU	€ 1.250,00
ARCHITECTURAL SYSTEM 3 LED: 60W - 100-240Vac/24Vdc 10.500 lumen - 3000 Kelvin (4000 Kelvin upon request) Dim. with: PWM, 0-10 or Potentiometer Made of: Lentiflex® Weight: net Kg 4,4 - gross Kg 6,8 Package: A 114 x 16 x h 16 cm (X3) B 44 x 26 x 6,5 cm		<input type="checkbox"/> PRISMA	HUGSSS3PRS01TAR000EU	€ 1.850,00
		<input type="checkbox"/> WHITE	HUGSSS3WHT01TAR000EU	€ 1.850,00
ARCHITECTURAL SYSTEM 4 LED: 80W - 100-240Vac/24Vdc 14.000 lumen - 3000 Kelvin (4000 Kelvin upon request) Dim. with: PWM, 0-10 or Potentiometer Made of: Lentiflex® Weight: net Kg 5,8 - gross Kg 9 Package: A 114 x 16 x h 16 cm (X4) B 44 x 26 x 6,5 cm		<input type="checkbox"/> PRISMA	HUGSSS4PRS01TAR000EU	€ 2.300,00
		<input type="checkbox"/> WHITE	HUGSSS4WHT01TAR000EU	€ 2.300,00
ARCHITECTURAL SYSTEM 5 LED: 100W - 100-240Vac/24Vdc 17.500 lumen - 3000 Kelvin (4000 Kelvin upon request) Dim. with: PWM, 0-10 or Potentiometer Made of: Lentiflex® Weight: net Kg 6,8 - gross Kg 10,7 Package: A 114 x 16 x h 16 cm (X5) B 44 x 26 x 6,5 cm		<input type="checkbox"/> PRISMA	HUGSSS5PRS01TAR000EU	€ 2.900,00
		<input type="checkbox"/> WHITE	HUGSSS5WHT01TAR000EU	€ 2.900,00

PRODUCT / PRODOTTO	DIMENSIONS / MISURE	COLOUR / COLORE	CODE / CODICE	PRICE VAT EXCL. PREZZO IVA ESCL.
ARCHITECTURAL SYSTEM 6 LED: 120W - 100-240Vac/24Vdc 21.000 lumen - 3000 Kelvin (4000 Kelvin upon request) Dim. with: PWM, 1-10 or Potentiometer Made of: Lentiflex® Weight: net Kg 8,3 - gross Kg 12,9 Package: A 114 x 16 x h 16 cm (X6) B 44 x 26 x 6,5 cm		<input type="checkbox"/> PRISMA	HUGSSS6PRS01TAR000EU	€ 3.500,00
		<input type="checkbox"/> WHITE	HUGSSS6WHT01TAR000EU	€ 3.500,00
		ADDITIONAL DIMMING SYSTEM DALI, BLUETOOTH, CASAMBI, TRIAC, UPON REQUEST		
ARCHITECTURAL SYSTEM 7 LED: 140W - 100-240Vac/24Vdc 24.500 lumen - 3000 Kelvin (4000 Kelvin upon request) Dim. with: PWM, 1-10 or Potentiometer Made of: Lentiflex® Weight: net Kg 9,3 - gross Kg 14,6 Package: A 114 x 16 x h 16 cm (X7) B 44 x 26 x 6,5 cm		<input type="checkbox"/> PRISMA	HUGSSS7PRS01TAR000EU	€ 4.100,00
		<input type="checkbox"/> WHITE	HUGSSS7WHT01TAR000EU	€ 4.100,00
		ADDITIONAL DIMMING SYSTEM DALI, BLUETOOTH, CASAMBI, TRIAC, UPON REQUEST		
ADDITIONAL MAGNETIC ALIGNMENT ROD With: Magnetic System® Made of: Transparent Methacrylate Weight: 0,1 kg		<input type="checkbox"/> TRANSPARENT	ACC00ALL0000T_HUG	€ 39,00

CANOPY DETAILS



HUGO ARCHITECTURAL

7-6-5-4: Ø 25,5 cm x h. 5 cm (Ø10" x h. 2")

2-3: Ø 19 cm x h. 5 cm (Ø 7-1/2" x h 2")

6m. cable kit must be ordered with lamp purchase
Kit Cavi da 6m da richiedere tassativamente in fase di ordine

HUGO ARCHITECTURAL SYSTEM COLLECTION

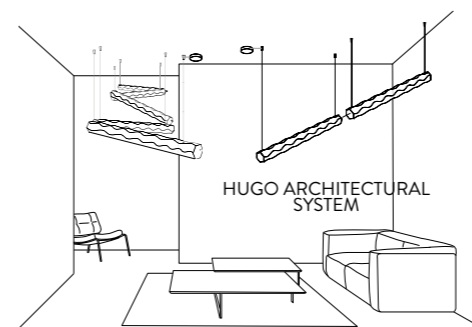

FINISHES



PRODUCT / PRODOTTO	DIMENSIONS / MISURE	COLOUR / COLORE	CODE / CODICE	PRICE VAT EXCL. / PREZZO IVA ESCL.
APPLIQUE Bulbs: 1X 5W G9 LED - 500 Lumen Dimmable with: Dimmable bulb Made of: Stainless Steel or White Coated Steel and Technopolymer With: Bulb included Weight: net 1,3Kg - gross 1,7 Kg Package: 38 x 36 x h. 15 cm		<input type="checkbox"/> WHITE	IDEWM00WHT00000000EU	€ 280,00
		<input checked="" type="checkbox"/> MIRROR	IDEWM00MRR00000000EU	€ 330,00
RECESSED WALL LAMP Bulbs: 1X 5W G9 LED - 500 Lumen Dimmable with: Dimmable bulb Made of: Plaster / Technopolymer With: Bulb included Weight: net 0,5 Kg - gross 1 Kg Package: 26 x 28 x h. 16 cm		<input type="checkbox"/> WHITE	IDEW000WHT000RD000EU	€ 220,00
		<input checked="" type="checkbox"/> BRASS	IDETM00BRS00000000EU	€ 330,00
TABLE Bulbs: 1X 5W G9 LED - 500 Lumen Made of: Brushed Brass / Technopolymer With: Bulb included Weight: net 1 Kg - gross 1,5 Kg Package: 19 x 18 x h. 50 cm		<input checked="" type="checkbox"/> BRASS	IDETM00BRS00000000EU	€ 330,00
		<input type="checkbox"/> WHITE	IDEW000WHT000RD000EU	€ 220,00
BULB DIMENSIONS: The included bulb is dimmable				

IDEA ENTIRE COLLECTION

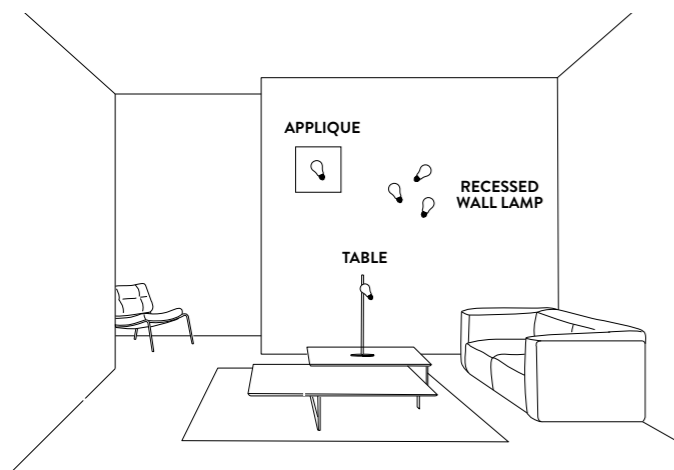

FINISHES



PRODUCT / PRODOTTO	DIMENSIONS / MISURE	COLOUR / COLORE	CODE / CODICE	PRICE VAT EXCL. / PREZZO IVA ESCL.
SUSPENSION Bulbs E27: 4 X 12W LED Filament Dimmable with: Dimmable bulbs Made of: Metallized Polycarbonate or Lentiflex® / Polycarbonate Weight: net Kg 3 - gross Kg 5,5 Package: 70 x 70 x h. 40 cm		<input type="checkbox"/> PRISMA	KLTSM00PRS01T000000EU	€ 650,00
		<input checked="" type="checkbox"/> BLACK-GOLD	KLTSM00BGD01T000000EU	€ 980,00
CEILING Bulbs E27: 4 X 12W LED Filament Dimmable with: Dimmable bulbs Made of: Metallized Polycarbonate or Lentiflex® / Polycarbonate Weight: net Kg 3 - gross Kg 5,5 Package: 70 x 70 x h. 40 cm		<input type="checkbox"/> PRISMA	KLTCM00PRS000000000EU	€ 580,00
		<input checked="" type="checkbox"/> BLACK-GOLD	KLTCM00BGD000000000EU	€ 910,00

CANOPY DETAILS



WHITE VERSION BLACK VERSION

KALATOS SUSPENSION
 Ø12 / Ø16 cm x h. 3 cm (Ø 4-3/4" / Ø 6- 1/4" x h. 1")
 6m. cable kit must be ordered with lamp purchase
 Kit Cavi da 6m da richiedere tassativamente in fase di ordine
 Kit di installazione multipla su richiesta
 Multiple installation kit on request

KALATOS ENTIRE COLLECTION

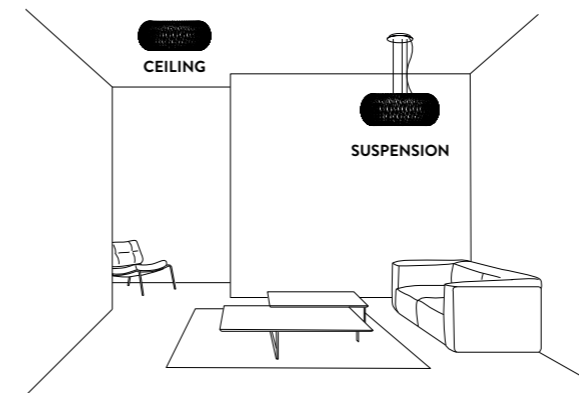



FINISHES



LA BELLE ÉTOILE

design by Adriano Rachele

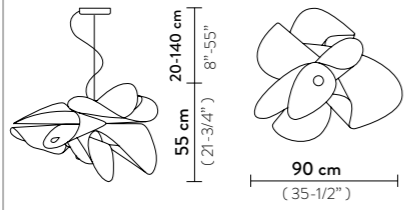
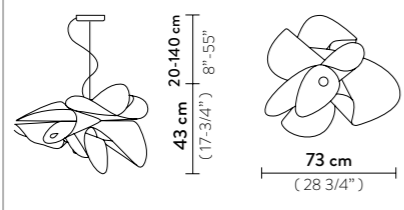
Compendium page 172 / 292 / 436

PRODUCT / PRODOTTO	DIMENSIONS / MISURE	COLOUR / COLORE	CODE / CODICE	PRICE VAT EXCL. / PREZZO IVA ESCL.
SUSPENSION LARGE LED: 21W - 110~240 Vac / 40Vdc - 2830 Lumen 2700 Kelvin (warm white) - CRI 90 Dimmable with: PWM, 0-10 Made of: Cristalflex® With: Patented Light Source with Magnetic System® Weight: net Kg 2,56 - gross Kg 7,8 Package: 100 x 81 x 49 cm		<input type="checkbox"/> WHITE	ETOSL00WHT01T00LEDEU	€ 830,00
		<input type="checkbox"/> BLACK	ETOSL00BLK01T00LEDEU	€ 850,00
SUSPENSION LED: 21W - 110~240 Vac / 40Vdc - 2830 Lumen 2700 Kelvin (warm white) - CRI 90 Dimmable with: PWM, 0-10 Made of: Cristalflex® With: Patented Light Source with Magnetic System® Weight: net Kg 2,6 - gross Kg 6 Package: 75 x 81 x h. 49 cm		<input type="checkbox"/> WHITE	ETOSS00WHT01T00LEDEU	€ 740,00
		<input type="checkbox"/> BLACK	ETOSS00BLK01T00LEDEU	€ 780,00
CEILING/WALL LED: 15W - 200~240 Vac / 40Vdc - 2150 Lumen 2700 Kelvin (warm white) - CRI 90 Dimmable with: Triac Trailing Edge Made of: Cristalflex® With: Patented Light Source with Magnetic System® Weight: net Kg 1,8 - gross Kg 4 Package: 80 x 80 x h. 30 cm		<input type="checkbox"/> WHITE	ETOCS00WHT00000LEDEU	€ 690,00
		<input type="checkbox"/> BLACK	ETOCS00BLK00000LEDEU	€ 720,00

CANOPY DETAILS



LA BELLE ÉTOILE / ÉTOILE

L/M: Ø14 cm x h. 3,2 cm (Ø 5-1/2" x h. 1-1/2")

6 m. cable kit also available for purchase after lamp order
 Kit Cavi da 6m acquistabile anche successivamente

PATENTED MAGNETIC SYSTEM® LIGHT SOURCE

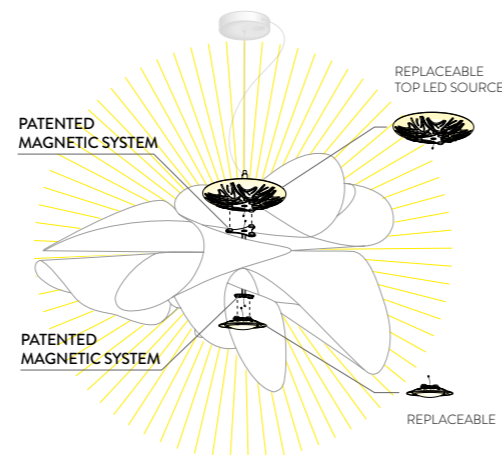

ÉTOILE

design by Adriano Rachele

Compendium page 180 / 294 / 438

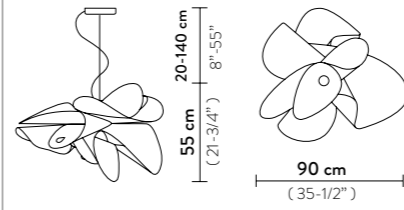
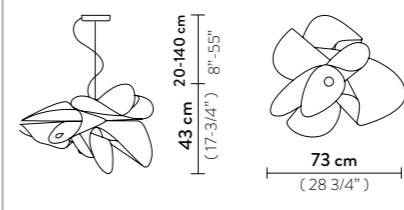
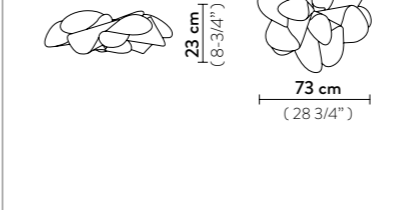
PRODUCT / PRODOTTO	DIMENSIONS / MISURE	COLOUR / COLORE	CODE / CODICE	PRICE VAT EXCL. / PREZZO IVA ESCL.
SUSPENSION LARGE LED: 21W - 110~240 Vac / 40Vdc - 2830 Lumen 2700 Kelvin (warm white) - CRI 90 Dimmable with: PWM, 0-10 Made of: Lentiflex® With: Patented Light Source with Magnetic System® Weight: net Kg 2,56 - gross Kg 7,8 Package: 100 x 81 x 49 cm		<input type="checkbox"/> PRISMA	ETOSL00PRS01T00LEDEU	€ 790,00
		ADDITIONAL DIMMING SYSTEM DALI, BLUETOOTH, CASAMBI, TRIAC UPON REQUEST		
SUSPENSION LED: 21W - 110~240 Vac / 40Vdc - 2830 Lumen 2700 Kelvin (warm white) - CRI 90 Dimmable with: PWM, 0-10 Made of: Lentiflex® With: Patented Light Source with Magnetic System® Weight: net Kg 2,6 - gross Kg 6 Package: 75 x 81 x h. 49 cm		<input type="checkbox"/> PRISMA	ETOSS00PRS01T00LEDEU	€ 700,00
		ADDITIONAL DIMMING SYSTEM DALI, BLUETOOTH, CASAMBI, TRIAC UPON REQUEST		
CEILING/WALL LED: 15W - 200~240 Vac / 40Vdc - 2150 Lumen 2700 Kelvin (warm white) - CRI 90 Dimmable with: Triac Trailing Edge Made of: Lentiflex® With: Patented Light Source with Magnetic System® Weight: net Kg 1,8 - gross Kg 4 Package: 80 x 80 x h. 30 cm		<input type="checkbox"/> PRISMA	ETOCS00PRS00000LEDEU	€ 670,00
		ADDITIONAL DIMMING SYSTEM DALI, BLUETOOTH, CASAMBI, PWM 0/10-1/10 UPON REQUEST		

LA BELLE ÉTOILE / ÉTOILE ENTIRE COLLECTION

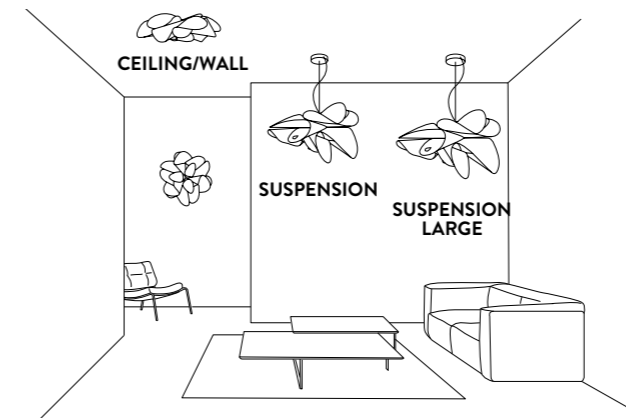

FINISHES

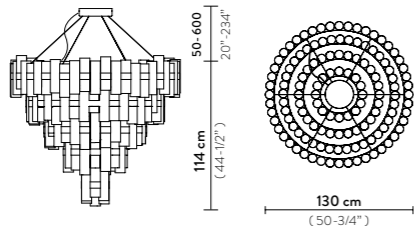
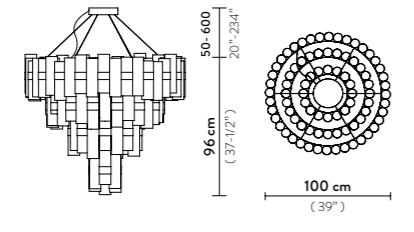
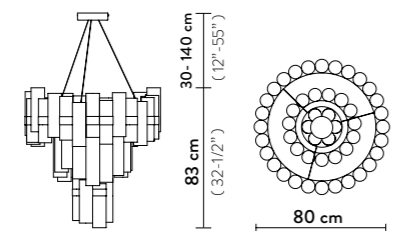
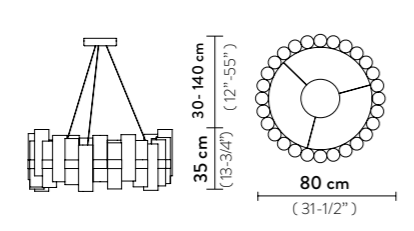

PRODUCT / PRODOTTO	DIMENSIONS / MISURE	COLOUR / COLORE	CODE / CODICE	PRICE VAT EXCL. PREZZO IVA ESCL.
LA LOLLONA 5 SUSPENSION LED: 390W - 100 ~240Vac / 24Vdc 44.555 Lumen - 2700 Kelvin (warm white) CRI > 90 Dimmable with: PWM, 0-10 or Potentiometer Made of: Lentiflex® / Cristalflex® Opalflex® Brushed Goldflex® or Pewterflex® Weight: net 22,6 kg - gross 67 kg Package: 140 x 140 x h. 56 cm		<input type="checkbox"/> WHITE	LALS5XLWHT06T00000EU	€ 6.700,00
		<input checked="" type="checkbox"/> GRADIENT <input type="checkbox"/> GOLD <input type="checkbox"/> PEWTER WHITE	LALS5XLGRD06T00000EU LALS5XLGLD06T00000EU LALS5XLPWT06T00000EU	€ 6.700,00 € 6.700,00 € 6.700,00
ADDITIONAL DIMMING SYSTEM DALI, CASAMBI UPON REQUEST				
LA LOLLONA 4 SUSPENSION LED: 242W - 100 ~240Vac / 24Vdc 28.140 Lumen - 2700 Kelvin (warm white) CRI > 90 Dimmable with: PWM, 0-10 or Potentiometer Made of: Lentiflex® / Cristalflex® Opalflex® Brushed Goldflex® or Pewterflex® Weight: net 19,6 kg - gross 58 kg Package: 114 x 114 x h. 64 cm		<input type="checkbox"/> WHITE	LALS4XLWHT06T00000EU	€ 5.100,00
		<input checked="" type="checkbox"/> GRADIENT <input type="checkbox"/> GOLD <input type="checkbox"/> PEWTER WHITE	LALS4XLGRD06T00000EU LALS4XLGLD06T00000EU LALS4XLPWT06T00000EU	€ 5.100,00 € 5.100,00 € 5.100,00
ADDITIONAL DIMMING SYSTEM DALI, CASAMBI UPON REQUEST				
SUSPENSION XL LED: 130W - 110~240Vac / 24Vdc 15.000 Lumen - 2700 Kelvin (warm white) CRI > 90 Dimmable with: PWM, 0-10 or Potentiometer Made of: Lentiflex® / Cristalflex® Opalflex® Brushed Goldflex® or Pewterflex® Weight: net Kg 7 - gross Kg 11,5 Package: 83 x 88 x h. 48 cm		<input type="checkbox"/> WHITE	LALSXLWHT01T00000EU	€ 2.100,00
		<input checked="" type="checkbox"/> GRADIENT <input type="checkbox"/> GOLD <input type="checkbox"/> PEWTER WHITE	LALSXLGRD01T00000EU LALSXLGLD01T00000EU LALSXL0PWT01T00000EU	€ 2.100,00 € 2.100,00 € 2.100,00
ADDITIONAL DIMMING SYSTEM DALI, BLUETOOTH, CASAMBI, TRIAC UPON REQUEST				
SUSPENSION LARGE LED: 80W - 110~240Vac / 24Vdc 9.000 Lumen - 2700 Kelvin (warm white) CRI > 90 Dimmable with: PWM, 1-10 or Potentiometer Made of: Lentiflex® / Cristalflex® Opalflex® Brushed Goldflex® or Pewterflex® Weight: net Kg 4 - gross Kg 9,5 Package: 83 x 88 x h. 48 cm		<input type="checkbox"/> WHITE	LALSLO0WHT01T00000EU	€ 1.300,00
		<input checked="" type="checkbox"/> GRADIENT <input type="checkbox"/> GOLD <input type="checkbox"/> PEWTER WHITE	LALSLO0GRD01T00000EU LALSLO0GLD01T00000EU LALSLO0PWT01T00000EU	€ 1.300,00 € 1.300,00 € 1.300,00
ADDITIONAL DIMMING SYSTEM DALI, BLUETOOTH, CASAMBI, TRIAC UPON REQUEST				

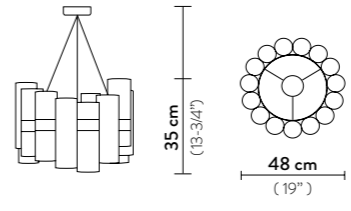
PRODUCT / PRODOTTO	DIMENSIONS / MISURE	COLOUR / COLORE	CODE / CODICE	PRICE VAT EXCL. PREZZO IVA ESCL.
SUSPENSION MEDIUM LED: 40W - 110~240Vac / 24Vdc 4.600 Lumen - 2700 Kelvin (warm white) CRI > 90 Dimmable with: PWM, 0-10 or Potentiometer Made of: Lentiflex® / Cristalflex® / Opalflex® Brushed Goldflex® or Pewterflex® Weight: net Kg 2 - gross Kg 4,3 Package: 54 x 55 x h. 44 cm		<input type="checkbox"/> WHITE	LALSM00WHT01T00000EU	€ 710,00
		<input checked="" type="checkbox"/> GRADIENT <input type="checkbox"/> GOLD <input type="checkbox"/> PEWTER WHITE	LALSM00GRD01T00000EU LALSM00GLD01T00000EU LALSM00PWT01T00000EU	€ 710,00 € 710,00 € 710,00
ADDITIONAL DIMMING SYSTEM DALI, BLUETOOTH, CASAMBI, TRIAC UPON REQUEST				

CANOPY DETAILS



LALOLLONA

LA LOLLONA 5 / 4: Ø31/35 cm x h. 5 cm (Ø 12/13-3/4" x h. 2")
 Standard cable kit: 6 m - *Kit cavi da 6m standard*

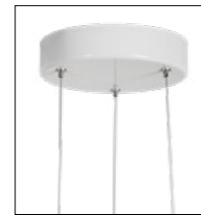

LALOLLO

XL: Ø25,5 cm x h. 5 cm (Ø10" x h. 2")
LARGE: Ø 25,5 cm x h. 5 cm (Ø10" x h. 2")
 6 m. cable kit also available for purchase after lamp order
Kit Cavi da 6m acquistabile anche successivamente

MEDIUM: Ø 16 cm x h. 3,5 cm (Ø 6-1/4" x h.1-1/2")
 6m. cable kit must be ordered with lamp purchase
Kit Cavi da 6m da richiedere tassativamente in fase di ordine

LA LOLLO ENTIRE COLLECTION

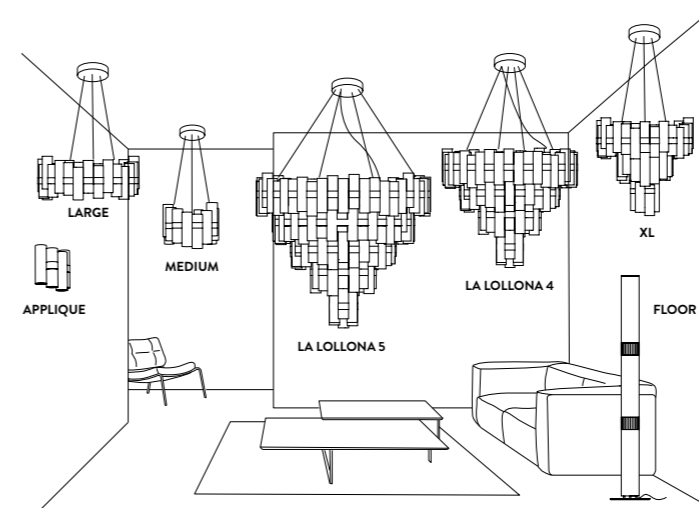

FINISHES



LA LOLLO APPLIQUE

design by Lorenza Bozzoli

Compendium page **414**

PRODUCT / PRODOTTO	DIMENSIONS / MISURE	COLOUR / COLORE	CODE / CODICE	PRICE VAT EXCL. / PREZZO IVA ESCL.
WALL LAMP Bulbs E14:  2 X 6W LED Filament Dimmable with: Dimmable bulbs Made of: Lentiflex® / Cristalflex® Opalflex® Brushed Goldflex® or Pewterflex® With: Stainless Steel Support Weight: net Kg 0,45 - gross Kg 1 Package: 33 x 34 x h. 19 cm		<input type="checkbox"/> WHITE	LALWM00WHT00000000EU	€ 220,00
		<input checked="" type="checkbox"/> GRADIENT	LALWM00GRD00000000EU	€ 220,00
		<input checked="" type="checkbox"/> GOLD	LALWM00GLD00000000EU	€ 220,00
		<input checked="" type="checkbox"/> PEWTER WHITE	LALWM00PWT00000000EU	€ 220,00

LA LOLLO FLOOR

design by Lorenza Bozzoli

Compendium page **464**

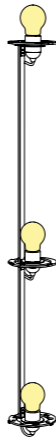
PRODUCT / PRODOTTO	DIMENSIONS / MISURE	COLOUR / COLORE	CODE / CODICE	PRICE VAT EXCL. / PREZZO IVA ESCL.
FLOOR LAMP Bulbs E27:  3 X 12W LED Filament Dimmable with: Dimmable bulbs Made of: Lentiflex® / Cristalflex® and Steelflex® or Goldflex® With: Stainless Steel Base - Dimmer Weight: net Kg 2,9 - gross Kg 5,9 Package: 30 x 35 x h. 170 cm BULBS DISPOSITION 		<input type="checkbox"/> PRISMA/SILVER	LALFM00PRS000000000EU	€ 630,00
		<input checked="" type="checkbox"/> PRISMA/GOLD	LALFM00PRG000000000EU	€ 630,00

LA LOLLO ENTIRE COLLECTION

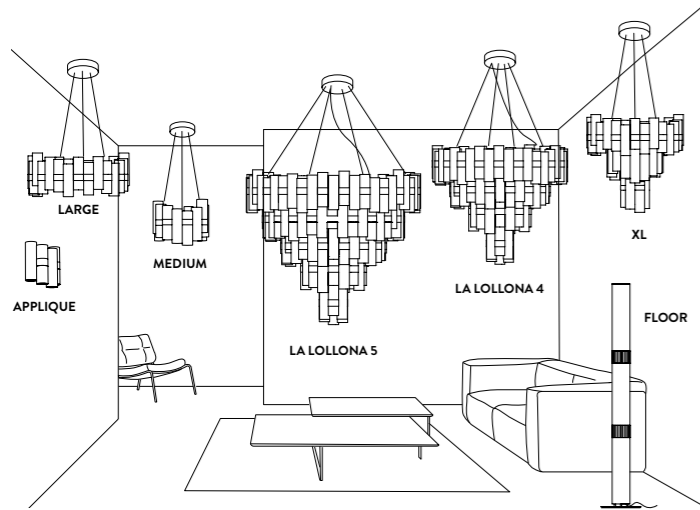

FINISHES

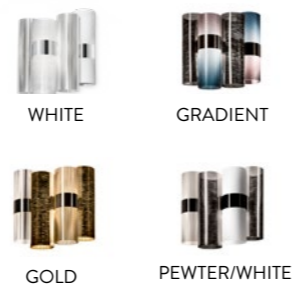

LA LOLLO ENTIRE COLLECTION

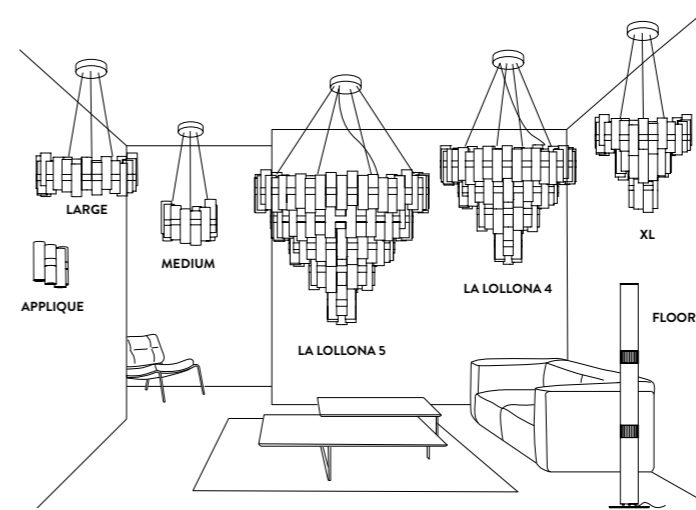

FINISHES



LA TRAVIATA

design by Robert Wilson

Compendium page 72

PRODUCT / PRODOTTO	DIMENSIONS / MISURE	COLOUR / COLORE	CODE / CODICE	PRICE VAT EXCL. / PREZZO IVA ESCL.
LIGHT SCULPTURE 220 LED: 13 individually dimmable RGB +1 MAIN LED: 100W - 100~240V 7500 Lumen - 2700 Kelvin Dimmable with: Control System Made of: Lentiflex® / Methacrilate With: DMX control included Weight: net 20 kg - gross 77,50 kg Package: 222 x 63 x 82 cm		<input type="checkbox"/> PRISMA	TRASL00PRS06TDX000EU	€ 13.000,00
		ADDITIONAL DIMMING SYSTEM DALI, BLUETOOTH, CASAMBI UPON REQUEST		
LIGHT SCULPTURE 180 LED: 9 individually dimmable RGB +1 MAIN LED: 75W - 100~240V 6000 Lumen - 2700 Kelvin Dimmable with: Control System Made of: Lentiflex® / Methacrilate With: DMX control included Weight: net 19,5 kg - gross 78 kg Package: 222 x 63 x 82 cm		<input type="checkbox"/> PRISMA	TRASM00PRS06TDX000EU	€ 10.500,00
		ADDITIONAL DIMMING SYSTEM DALI, BLUETOOTH, CASAMBI UPON REQUEST		

CANOPY DETAILS



LA TRAVIATA LIGHT SCULPTURE

23/28 x 8,3/12,7 x h. 4,3 cm
 (9/11" x 3-1/4" / 5" h. 1-1/2")

Standard cable kit: 6 m
 Kit cavi da 6m standard

LA TRAVIATA ENTIRE COLLECTION

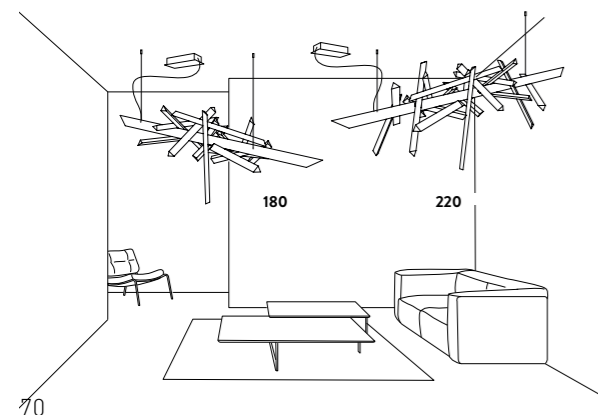

FINISHES



PRISMA + RGB LIGHTS

LAS PALMAS

design by Jonas Clementoni

Compendium page 496 / 380

PRODUCT / PRODOTTO	DIMENSIONS / MISURE	COLOUR / COLORE	CODE / CODICE	PRICE VAT EXCL. / PREZZO IVA ESCL.
FLOOR XL Bulbs E27: 3 X 12W LED Filament Made of: Opalflex® / Polycarbonate With: Stainless Steel base- profiles Weight: net Kg 4,4 - gross Kg 8,5 Package: 45 x 43 x h. 156 cm		<input type="checkbox"/> WHITE	PALFXLOWHT00000000EU	€ 630,00
		ADDITIONAL DIMMING SYSTEM DALI, BLUETOOTH, CASAMBI UPON REQUEST		
FLOOR LARGE Bulbs E27: 2 X 12W LED Filament Made of: Opalflex® / Polycarbonate With: Stainless Steel base- profiles Weight: net Kg 2,9 - gross Kg 5,4 Package: 35 x 36 x h. 122 cm		<input type="checkbox"/> WHITE	PALFL00WHT00000000EU	€ 440,00
		ADDITIONAL DIMMING SYSTEM DALI, BLUETOOTH, CASAMBI UPON REQUEST		
TABLE SMALL Bulbs E14: 1 X 6W LED Filament Made of: Opalflex® / Polycarbonate With: Stainless Steel base- profiles Weight: net Kg 1,1 - gross Kg 2 Package: 20 x 21 x h. 62 cm		<input type="checkbox"/> WHITE	PALTS00WHT00000000EU	€ 220,00
		ADDITIONAL DIMMING SYSTEM DALI, BLUETOOTH, CASAMBI UPON REQUEST		

LAS PALMAS ENTIRE COLLECTION

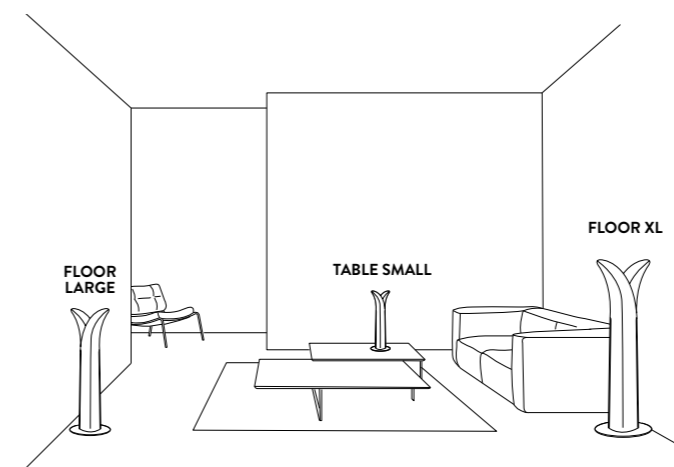

FINISHES

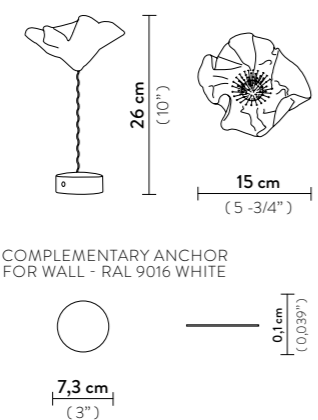
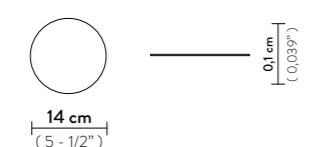
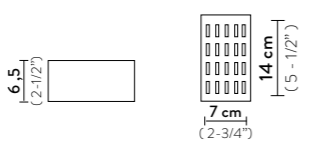

WHITE

PRODUCT / PRODOTTO	DIMENSIONS / MISURE	COLOUR / COLORE	CODE / CODICE	PRICE VAT EXCL PREZZO IVA ESCL
TABLE LAMP LED: 1.3 W dimmable LED – 150 Lumen 2700 Kelvin - Rechargeable Li-ion Polymer Cell 3.7 Vdc 2500 mAh Charge 5 Vdc 1 A Battery duration: at max. intensity around 6,5 hours duration, at min. intensity around 60 hours duration With: USB/ DC plug included Magnetic base and complementary anchor Made of: Lentiflex® / Copper wires Weight: net Kg 0,2 - gross Kg 0,6 Package: 19 x 19 x h 35 cm	 <p>26 cm (10")</p> <p>15 cm (5-3/4")</p> <p>COMPLEMENTARY ANCHOR FOR WALL - RAL 9016 WHITE</p> <p>0,1 cm (0,039")</p> <p>7,3 cm (3")</p>	PRISMA WITH WHITE BASE	LAFT000PRS000BT000EU	€ 260,00
		VELVET WITH BLACK BASE	LAFT000VLV000BT000EU	€ 260,00
ADDITIONAL LARGE MAGNETIC ANCHOR DISC RAL 9016 WHITE To be placed under a tablecloth or other fabric covering	 <p>14 cm (5-1/2")</p> <p>0,1 cm (0,039")</p>	<input type="checkbox"/> WHITE	ACC00TAV0003W_LAF	€ 25,00
USB MULTICHARGER STATION 20 PORTS With: 20 USB, wire 1,50 m fan automatic heat dissipation Weight: net Kg 0,49 - gross Kg 0,53 Package: 15,5 x 15,5 x h. 7cm	 <p>6,5 (2-1/2")</p> <p>14 cm (5-1/2")</p> <p>7 cm (2-3/4")</p>		ACC00CHAP020_000	€ 195,00

LAFLEUR ENTIRE COLLECTION

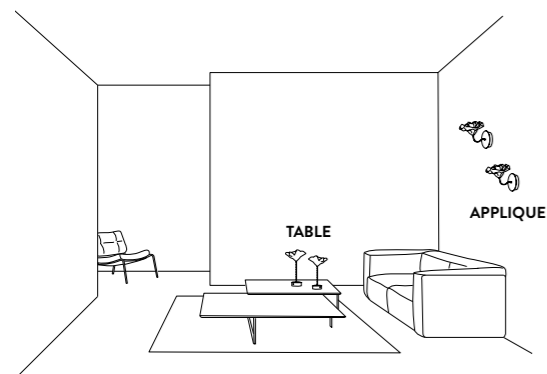

FINISHES

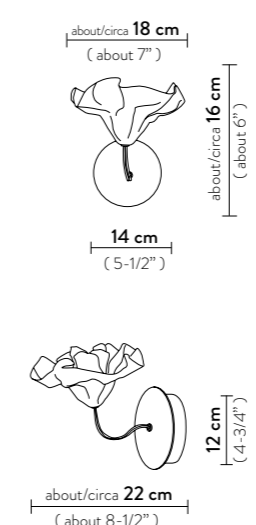

PRODUCT / PRODOTTO	DIMENSIONS / MISURE	COLOUR / COLORE	CODE / CODICE	PRICE VAT EXCL PREZZO IVA ESCL
LAFLEUR APPLIQUE Bulbs:  1 X 3W G4 Dimmable LED Bulbs Power Supply: 110~220Vac / 12 Vdc Dimmable with Triac With: Bulb included (450 Lumen - 2900 / 3000 Kelvin) Made of: Lentiflex® / Copper Wires and Painted iron structure Additional dimming system Dali, Bluetooth, Casambi, upon request Weight: net Kg 0,6 - gross Kg 1,2 Package: 27 x 27,5 x h. 25 cm	 <p>about/circa 18 cm (about 7")</p> <p>about/circa 16 cm (about 6")</p> <p>14 cm (5-1/2")</p> <p>12 cm (4-3/4")</p> <p>about/circa 22 cm (about 8-1/2")</p>	PRISMA WHITE STRUCTURE	LAFWM00PRS00000000EU	€ 230,00
		VELVET BLACK STRUCTURE	LAFWM00VLV00000000EU	€ 250,00
	<p>Stated dimension may vary by several cm/inches as the the blossom-decor is handcrafted.</p> <p>L'ingombro dichiarato potrebbe variare di qualche cm/inches poiché la corolla-diffusore realizzata a mano.</p>			

LAFLEUR ENTIRE COLLECTION

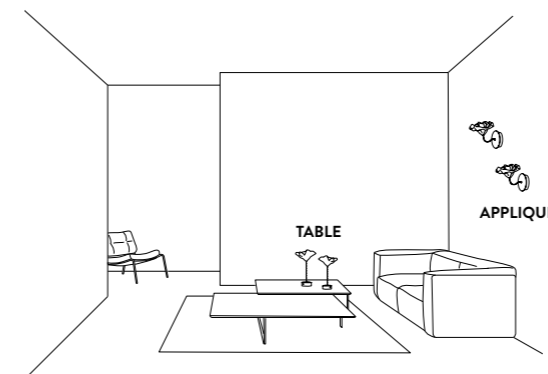



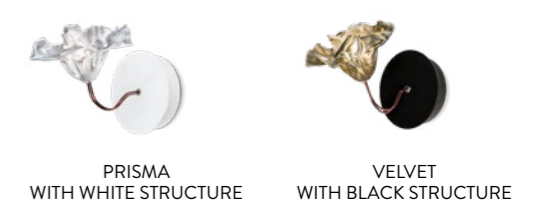

FINISHES

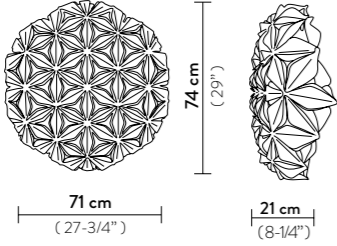
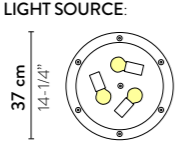

LAVIE CEILING / WALL by Adriano Rachele

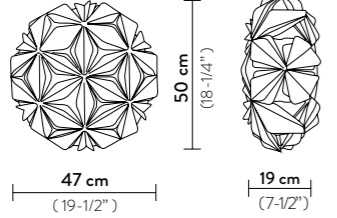
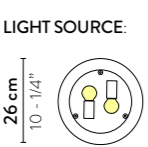
Compendium page 244 / 394

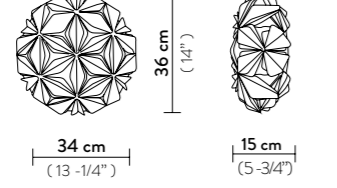
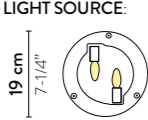
PRODUCT / PRODOTTO	DIMENSIONS / MISURE	COLOUR / COLORE	CODE / CODICE	PRICE VAT EXCL. / PREZZO IVA ESCL.
CEILING/WALL LARGE Bulbs E27:  3 X 12W LED Filament Dimmable with: Dimmable bulbs Made of: Lentiflex® / Opalflex® With: Magnetic System Weight: net Kg 3,23- gross Kg 5,80 Package: 80 x 80 x h. 30 cm	 <p>LIGHT SOURCE:</p> 	<input type="checkbox"/> WHITE	LAVCL00WHT000000000EU	€ 520,00
		<input checked="" type="checkbox"/> AMBER	LAVCL00ORG000000000EU	€ 520,00
		<input checked="" type="checkbox"/> BLUE	LAVCL00BLU000000000EU	€ 520,00
CEILING/WALL MEDIUM Bulbs E27:  2 X 12W LED Filament Dimmable with: Dimmable bulbs Made of: Lentiflex® / Opalflex® With: Magnetic System Weight: net Kg 1,35 - gross Kg 2,75 Package: 57 x 57 x h. 23 cm	 <p>LIGHT SOURCE:</p> 	<input type="checkbox"/> WHITE	LAVCM00WHT000000000EU	€ 310,00
		<input checked="" type="checkbox"/> AMBER	LAVCM00ORG000000000EU	€ 310,00
		<input checked="" type="checkbox"/> BLUE	LAVCM00BLU000000000EU	€ 310,00
		<input checked="" type="checkbox"/> MULTIGREEN	LAVCM00MGN000000000EU	€ 310,00
		<input checked="" type="checkbox"/> MULTIBLUE	LAVCM00MBL000000000EU	€ 310,00
CEILING / WALL MINI Bulbs E14:  2 X 6W LED Filament Dimmable with: Dimmable bulbs Made of: Lentiflex® / Opalflex® With: Magnetic System Weight: net Kg 0,74 - gross Kg 1,21 Package: 36 x 38 x h. 15 cm	 <p>LIGHT SOURCE:</p> 	<input type="checkbox"/> WHITE	LAVCS00WHT000000000EU	€ 210,00
		<input checked="" type="checkbox"/> AMBER	LAVCS00ORG000000000EU	€ 210,00
		<input checked="" type="checkbox"/> BLUE	LAVCS00BLU000000000EU	€ 210,00

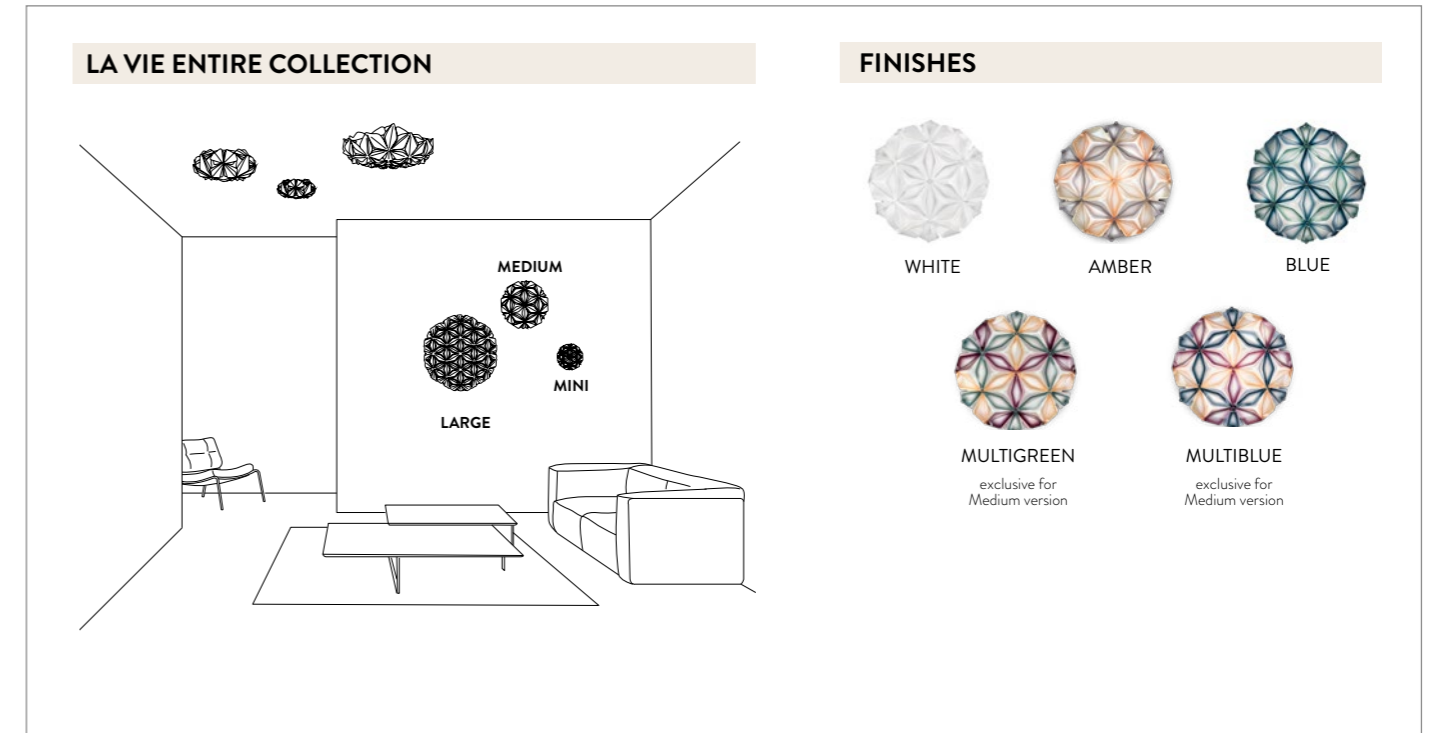

PRODUCT / PRODOTTO	DIMENSIONS / MISURE	COLOUR/COLORE	CODE / CODICE	PRICE VAT EXCL. / PREZZO IVA ESCL.
SUSPENSION Bulbs E27: 1 X 12W LED Filament Dimmable with: Dimmable bulbs Made of: Opalflex® / Cristalflex® Goldflex® / Steelflex® / Copperflex® With: 56 Schöler Crystals Weight: net Kg 2 - gross Kg 4,5 Package: 48 x 33 x h. 59 cm	<p>min 20 cm max 140 cm min 8" max 55" 47 cm (18") 66 cm (26")</p>	TRANSP	LILSM00TRS01T000000EU	€ 510,00
		WHITE	LILSM00WHT01T000000EU	€ 510,00
		FUMÉ	LILSM00FUM01T000000EU	€ 510,00
		BLACK	LILSM00BLK01T000000EU	€ 510,00
		GOLD	LILSM00GLD01T000000EU	€ 730,00
		SILVER	LILSM00SLV01T000000EU	€ 730,00
COPPER	LILSM00CPP01T000000EU	€ 730,00		
SUSPENSION MINI Bulbs E14: 1 X 6W LED Filament Dimmable with: Dimmable bulbs Made of: Opalflex® or Cristalflex® With: 42 Schöler Crystals Weight: net Kg 0,65 - gross Kg 1,5 Package: 43 x 25 x h. 13 cm	<p>min 20 cm max 140 cm min 8" max 55" 32 cm (12") 38 cm (15")</p>	TRANSP	LILSS00TRS01T000000EU	€ 350,00
		WHITE	LILSS00WHT01T000000EU	€ 350,00
		FUMÉ	LILSS00FUM01T000000EU	€ 350,00
		BLACK	LILSS00BLK01T000000EU	€ 350,00
WALL LAMP MINI Bulbs E14: 1 X 6W LED Filament Dimmable with: Dimmable bulbs Made of: Opalflex® or Cristalflex® With: 26 Schöler Crystals Weight: net Kg 0,65 - gross Kg 1,5 Package: 43 x 25 x h. 13 cm	<p>32 cm (12") 38 cm (15") 21 cm (8")</p>	TRANSP	LILWS00TRS0000000000EU	€ 270,00
		WHITE	LILWS00WHT0000000000EU	€ 270,00
		FUMÉ	LILWS00FUM0000000000EU	€ 270,00
		BLACK	LILWS00BLK0000000000EU	€ 270,00

CANOPY DETAILS



LILLIBET SUSPENSION
 Ø 12 cm x h. 6 cm (Ø 4-3/4" x h. 2-1/4")
LILLIBET SUSPENSION MINI
 Ø 10 cm x h. 5,5 cm (Ø 4" x h. 2")
 6m. cable kit must be ordered with lamp purchase
 Kit Cavi da 6m da richiedere tassativamente in fase di ordine

Kit di installazione multipla su richiesta
 Multiple installation kit on request

LILLIBET ENTIRE COLLECTION

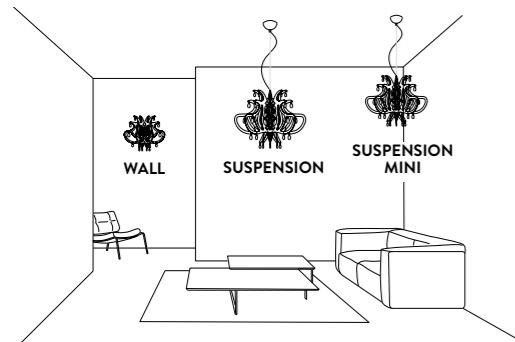

FINISHES



PRODUCT / PRODOTTO	DIMENSIONS / MISURE	COLOUR/COLORE	CODE / CODICE	PRICE VAT EXCL. / PREZZO IVA ESCL.
TABLE Hat Bulb E27: 1 X 12W LED Filament Base Bulb : 1 X 5W G9 LED Made of: Lentiflex® / Pewterflex® Polycarbonate / Cristalflex® With: 2 positions high switch Courtesy base G9 LED bulb (included) Weight: net Kg 3 - gross Kg 4,6 Package: 38 x 39 x h. 80 cm	<p>70 cm (27") 35 cm (13")</p>	PRISMA	LIZTM00PRS00G90000EU	€ 440,00
		PEWTER	LIZTM00PWT00G90000EU	€ 640,00
SUSPENSION Bulbs E27: 1 X 12W LED Filament Dimmable with: Dimmable bulbs Made of: Lentiflex® - Polycarbonate Weight: net Kg 2 - gross Kg 3,3 Package: 45 x 45 x h. 43 cm	<p>min 20 cm max 140 cm min 8" max 55" 33 cm (12-3/4") 45 cm (13-3/4")</p>	PRISMA	LIZSM00PRS01T000000EU	€ 330,00

CANOPY DETAILS



LIZA SUSPENSION
 Ø 12 cm x h. 3,2 cm (Ø 4-3/4" x h 1-1/4")
 6m. cable kit must be ordered with lamp purchase
 Kit Cavi da 6m da richiedere tassativamente in fase di ordine
 Kit di installazione multipla su richiesta
 Multiple installation kit on request

LIZA ENTIRE COLLECTION

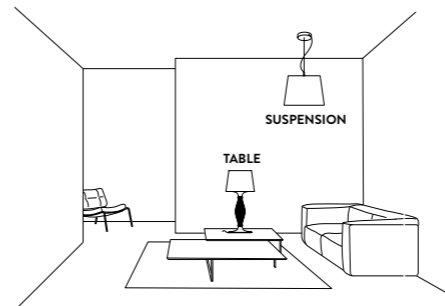

FINISHES



PRODUCT / PRODOTTO	DIMENSIONS / MISURE	COLOUR / COLORE	CODE / CODICE	PRICE VAT EXCL. / PREZZO IVA ESCL.
SUSPENSION Bulbs E27: 1 X 12W LED Filament Dimmable with: Dimmable bulbs Made of: Lentiflex® - Opalflex® Weight: net Kg 0,6 - gross Kg 1,9 Package: 41 x 41 x h. 41 cm		GOLD	LUISM00GLD01T00000EU	€ 190,00
		BLUE	LUISM00BLU01T00000EU	€ 190,00
		PURPLE	LUISM00PRP01T00000EU	€ 190,00

PRODUCT / PRODOTTO	DIMENSIONS / MISURE	COLOUR / COLORE	CODE / CODICE	PRICE VAT EXCL. / PREZZO IVA ESCL.
SUSPENSION Bulbs E27: 1 X 12W LED Filament Dimmable with: Dimmable bulbs Made of: Opalflex® / Pewterflex® With: 56 Crystals Weight: net Kg 4,5 - gross Kg 6,8 Package: 59 x 35 x h. 46 cm		BLUE/GEL	MEDSM00BLU01T00000EU	€ 2.200,00
		BLACK	MEDSM00BLK01T00000EU	€ 2.200,00
		PEWTER	MEDSM00PWT01T00000EU	€ 2.200,00
WALL LAMP Bulbs E27: 1 X 12W LED Filament Dimmable with: Dimmable bulbs Made of: Opalflex® / Cristalflex® With: 26 Crystals Stainless Steel support Weight: net Kg 2,6 - gross Kg 3,5 Package: 57 x 20 x h. 36 cm		BLUE/GEL	MEDWM00BLU000000000EU	€ 890,00
		BLACK	MEDWM00BLK000000000EU	€ 890,00

CANOPY DETAILS



LUIS
Ø10 cm x h. 5,5 cm (Ø 4" x h. 2")
6m. cable kit must be ordered with lamp purchase
Kit Cavi da 6m da richiedere tassativamente in fase di ordine
Kit di installazione multipla su richiesta
Multiple installation kit on request

CANOPY DETAILS



MEDUSA SUSPENSION
Ø 12 cm x h. 6 cm (Ø 4-3/4" x h. 2-1/4")
6m. cable kit must be ordered with lamp purchase
Kit Cavi da 6m da richiedere tassativamente in fase di ordine
Kit di installazione multipla su richiesta
Multiple installation kit on request

LUIS ENTIRE COLLECTION

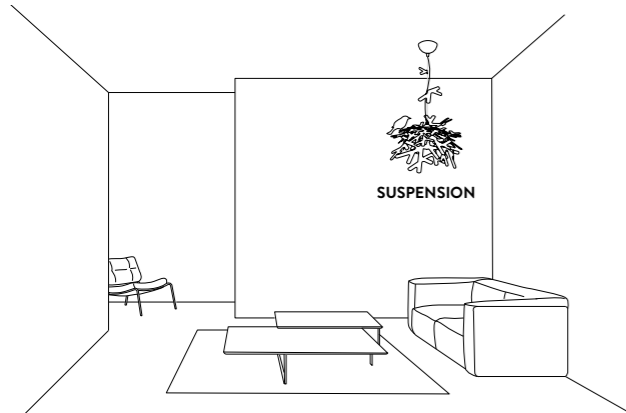

FINISHING

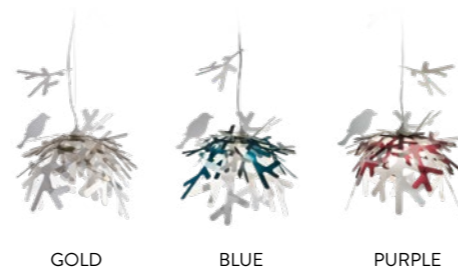

MEDUSA ENTIRE COLLECTION

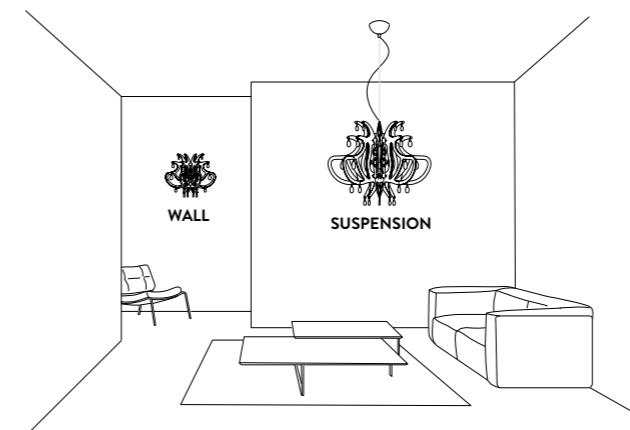









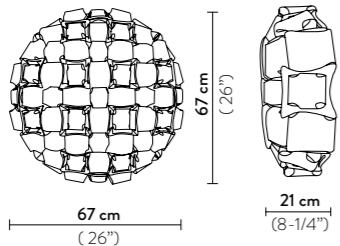
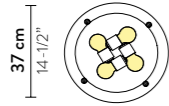



FINISHES

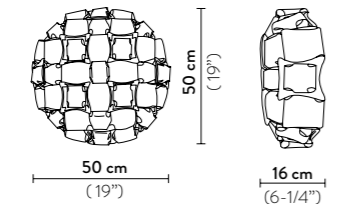
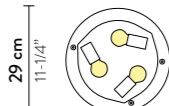

MIDA CEILING / WALL by Adriano Rachele





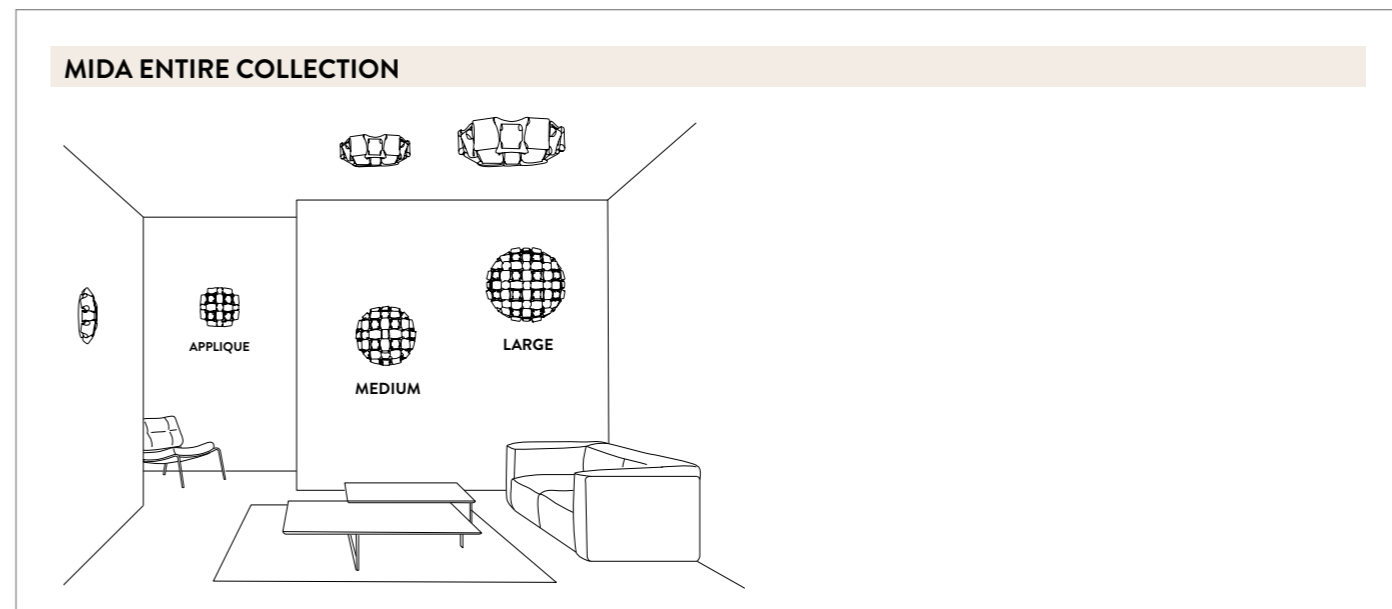

Compendium page **258 / 388**

PRODUCT / PRODOTTO	DIMENSIONS / MISURE	COLOUR / COLORE	CODE / CODICE	PRICE VAT EXCL PREZZO IVA ESCL.
CEILING-WALL LARGE Bulbs E27:  4 X 12W LED Filament Dimmable with: Dimmable bulbs Made of: Lentiflex® / Opalflex® Goldflex® / Steelflex® / Copperflex® With: MagneticSystem® Weight: net Kg 3,5 - gross Kg 6 Package: 80 x 80 x h. 30 cm	 LIGHT SOURCE: 	 WHITE - PLATINUM	MIDCL00SLV00000000EU	€ 790,00
		 WHITE - GOLD	MIDCL00GLD00000000EU	€ 790,00
		 ROSE	MIDCL00PNK00000000EU	€ 790,00
		 AMBER	MIDCL00YLW00000000EU	€ 790,00
		 MULTICOLOR	MIDCL00MCL00000000EU	€ 790,00
CEILING-WALL MEDIUM Bulbs E27:  3 X 12W LED Filament Dimmable with: Dimmable bulbs Made of: Lentiflex® / Opalflex® Goldflex® / Steelflex® / Copperflex® With: MagneticSystem® Weight: net Kg 2 - gross Kg 3 Package: 55 x 57 x h. 23 cm	 LIGHT SOURCE: 	 WHITE - PLATINUM	MIDCM00SLV00000000EU	€ 420,00
		 WHITE - GOLD	MIDCM00GLD00000000EU	€ 420,00
		 ROSE	MIDCM00PNK00000000EU	€ 420,00
		 AMBER	MIDCM00YLW00000000EU	€ 420,00
		 MULTICOLOR	MIDCM00MCL00000000EU	€ 420,00

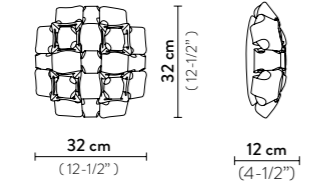
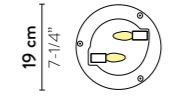

MIDA APPLIQUE design by Adriano Rachele

Compendium page **392**

PRODUCT / PRODOTTO	DIMENSIONS / MISURE	COLOUR / COLORE	CODE / CODICE	PRICE VAT EXCL PREZZO IVA ESCL.
APPLIQUE Bulbs E14:  2 X 6W LED Filament Dimmable with: Dimmable bulbs Made of: Lentiflex® / Opalflex® Goldflex® / Steelflex® / Copperflex® With: MagneticSystem® Weight: net Kg 0,50 - gross Kg 1,5 Package: 36 x 38 x h. 15 cm	 LIGHT SOURCE: 	 WHITE - PLATINUM	MIDWS00SLV00000000EU	€ 230,00
		 WHITE - GOLD	MIDWS00GLD00000000EU	€ 230,00
		 ROSE	MIDWS00PNK00000000EU	€ 230,00
		 AMBER	MIDWS00YLW00000000EU	€ 230,00
		 MULTICOLOR	MIDWS00MCL00000000EU	€ 230,00

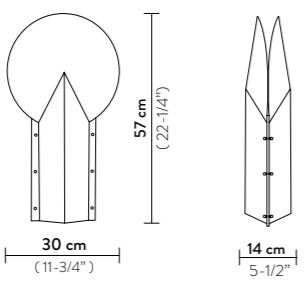

PRODUCT / PRODOTTO	DIMENSIONS / MISURE	COLOUR / COLORE	CODE / CODICE	PRICE VAT EXCL. / PREZZO IVA ESCL.
TABLE Bulbs E27:  1 X 12W LED Filament Made of: Opalflex® With: Aluminium profiles with a brushed brass finish - Silk screen printing Marble Texture Weight: net Kg 1 - gross Kg 1,5 Package: 29 x 30 x h. 60 cm		<input checked="" type="checkbox"/> BLACK	MOOTM00BLK00000000EU	€ 130,00
		<input type="checkbox"/> WHITE	MOOTM00WHT00000000EU	€ 130,00
		<input type="checkbox"/> PINK	MOOTM00PNK00000000EU	€ 130,00



MOON ENTIRE COLLECTION

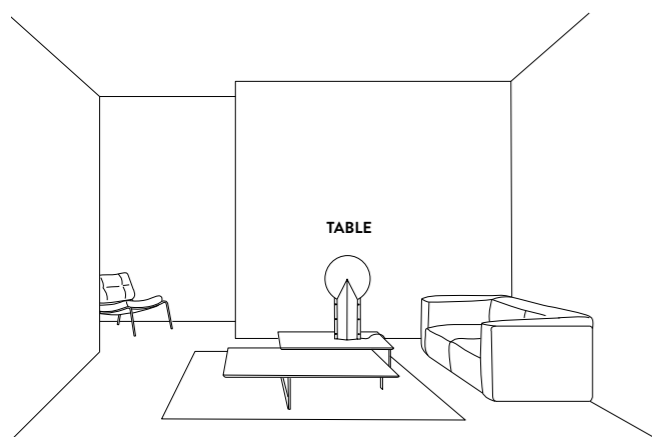

FINISHES



BLACK

WHITE

PINK

ODEON CEILING

design by Lorenza Bozzoli

Compendium page 264

PRODUCT / PRODOTTO	DIMENSIONS / MISURE	COLOUR / COLORE	CODE / CODICE	PRICE VAT EXCL. - PREZZO IVA ESCL.
CEILING 100 Bulbs E27: 12 X 12W LED Filament + 1 X 6,5 W Spot LED PAR 38 (Ø12,2 cm x h.13 cm) Dimmable with: Dimmable bulbs Made of: Lentiflex® / Goldflex® Weight: net Kg 15 - gross Kg 54 Package: 114 x 114 x h. 64 cm		GOLD	ODECL00GLD00000000EU	€ 2.990,00
CEILING 65 Bulbs E27: 6 X 12W LED Filament + 1 X 6,5 W Spot LED PAR 38 (Ø12,2 cm x h.13 cm) Dimmable with: Dimmable bulbs Made of: Lentiflex® / Goldflex® Weight: net Kg 6 - gross Kg 10 Package: 75 x 81 x h. 49 cm		GOLD	ODECM00GLD00000000EU	€ 1.225,00

ODEON ENTIRE COLLECTION

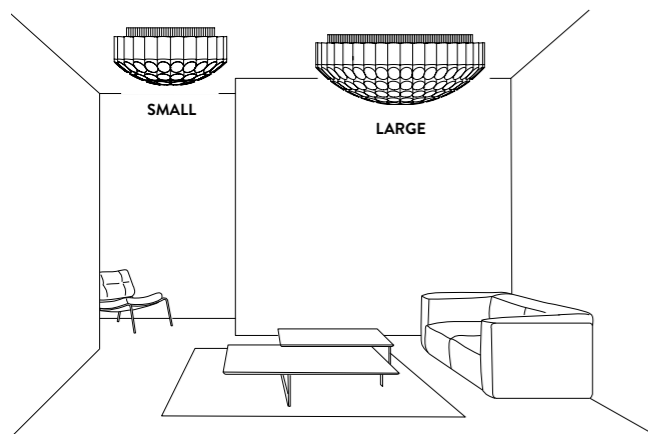

FINISHES



GOLD

OVERLAY

design by Analogia Project

Compendium page 356

PRODUCT / PRODOTTO	DIMENSIONS / MISURE	COLOUR / COLORE	CODE / CODICE	PRICE VAT EXCL. - PREZZO IVA ESCL.
TABLE Shade LED: 4W - 24Vdc - 500 Lumen 2700 Kelvin - CRI > 90 Base Courtesy LED: 1,5W - 24Vdc - 90 Lumen 2700 Kelvin - CRI > 90 Made of: Brass, Brushed Copperflex® and Lentiflex® Whit: LED courtesy light in the base, independent from the principle light source Montblanc Meisterstück Legrand Ballpoint pen Weight: net Kg 1,45 - gross Kg 6 Package: 31 x 58 x h. 60 cm		COPPER - BALLPOINT PEN	OVET000CPP000BP000EU	€ 3.200,00
		<p>Meisterstück LeGrand Ballpoint Pen Gold-Coated</p>		

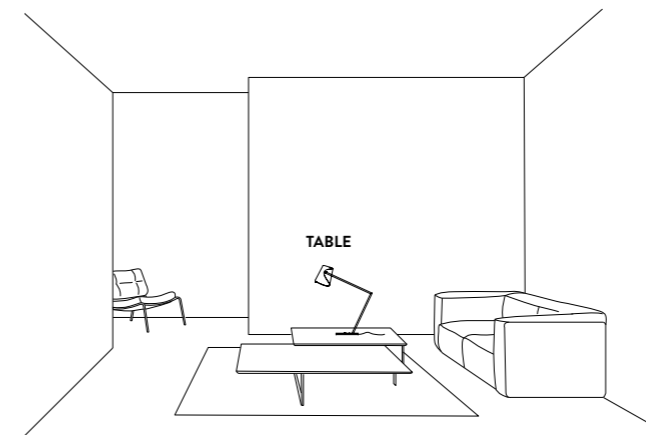

OVERLAY ENTIRE COLLECTION



FINISHES

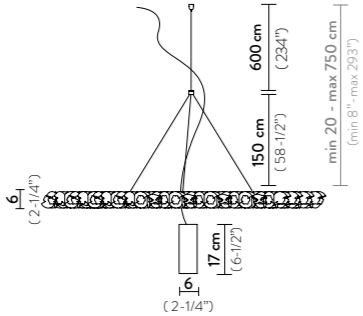
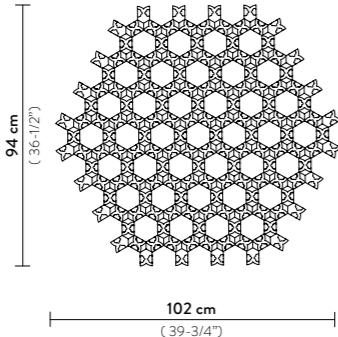

COPPER AND BRASS

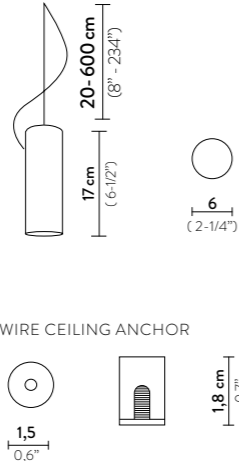
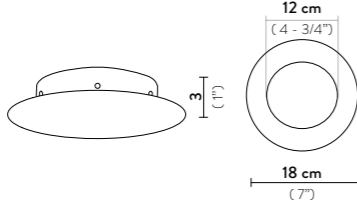
PRODUCT / PRODOTTO	DIMENSIONS / MISURE	COLOUR / COLORE	CODE / CODICE	PRICE VAT EXCL. PREZZO IVA ESCL.
MODULAR SUSPENSION Bidirectional Bulbs GU10:  2 X 8W GU10 PAR16 LED Dimmable with: Dimmable bulbs Made of: Opalflex® or Lentiflex® Weight: net 2,2 kg - gross 3 kg Package: A 100 x 107 x h. 7 (3 kg) B 13 x 21 x h. 10 cm (0,75kg) With: GU10Bulbs on request Standard cable kit: 6 m Canopy not included		<input type="checkbox"/> WHITE	NUVSM00WHT06T00000EU	€ 470,00
		<input checked="" type="checkbox"/> VELVET	NUVSM00VLV06T00000EU	€ 590,00
ADDITIONAL MODULE Made of: Opalflex® or Lentiflex® Weight: net 2,2 kg - gross 3 kg Package: A 100 x 107 x h. 7 (3 kg) With: Standard cable kit: 6 m		<input type="checkbox"/> WHITE	NUVS000WHT06TNS000EU	€ 330,00
		<input checked="" type="checkbox"/> VELVET	NUVS000VLV06TNS000EU	€ 390,00
ADDITIONAL BIDIRECTIONAL SPOTLIGHT Bidirectional Bulbs GU10:  2 X GU10 X 8W LED Dimmable with: Dimmable bulbs Made of: Steel RAL9016 - White Steel with brushed brass finishing- Velvet With: 1 wire ceiling anchor included Weight: net 0,7 kg - gross 0,8 kg Package: 13 x 21 x h. 10 cm With: Standard electric wires and steel cable 6 m - GU10 bulbs on request		<input type="checkbox"/> WHITE	ACC00SPO0000_NUV	€ 139,00
		<input checked="" type="checkbox"/> VELVET	ACC00SPO0000VLNUV	€ 199,00
CANOPY 1 Canopy max 6 electric wires Made of: Steel - White RAL9016 Weight: net Kg 0,25 - gross Kg 0,5 Package: 19 x 19 x h. 6 cm		<input type="checkbox"/> WHITE	ACC00COP0000_NUV	€ 85,00
		<input checked="" type="checkbox"/> VELVET		

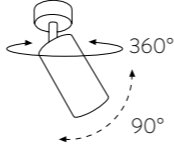
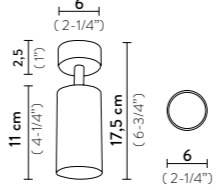
PRODUCT / PRODOTTO	DIMENSIONS / MISURE	COLOUR / COLORE	CODE / CODICE	PRICE VAT EXCL. PREZZO IVA ESCL.
ADDITIONAL CEILING/WALL SPOTLIGHT Bulbs GU10:  1 X GU10 X 8W LED Dimmable with: Dimmable bulbs Made of: Steel - White RAL9016 Weight: net 0,3 kg - gross 0,5 kg Package: 6,5 x 6,5 x h. 22 cm 		<input type="checkbox"/> WHITE	ACC00PLF0000W_NUV	€ 80,00
		<input checked="" type="checkbox"/> VELVET		

CANOPY DETAILS



NUVEM

Ø 18 / 12 cm x h. 3 cm (Ø 7" / 4-3/4" x h. 1")
 La coppetta ospita fino 6 cavi elettrici
 Canopy max 6 electric wires
 Standard cable kit: 6 m - Kit cavi da 6m standard

NUVEM ENTIRE COLLECTION

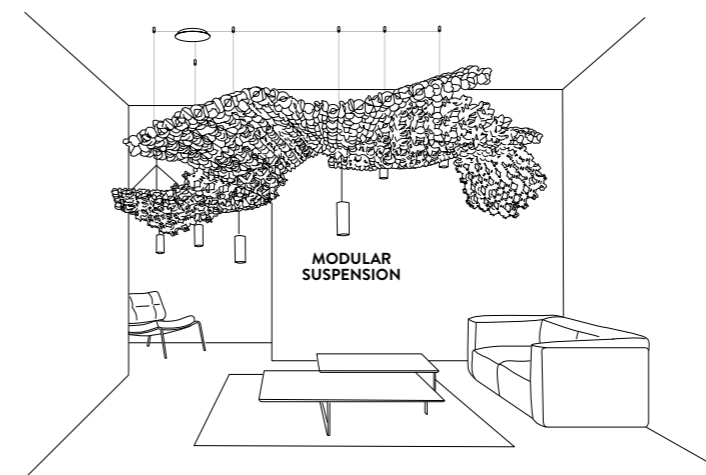

FINISHES



WHITE

VELVET

SUSPENSION SPOTLIGHT
BIDIRECTIONAL

CEILING/WALL
SPOTLIGHT





ph. Pedro Sadio

SUPERMORGANA

design by Stefano Papi

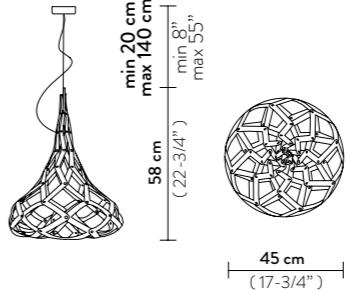
Compendium page 214

PRODUCT / PRODOTTO	DIMENSIONS / MISURE	COLOUR / COLORE	CODE / CODICE	PRICE VAT EXCL PREZZO IVA ESCL
SUSPENSION Bulbs G9:  1 X 5W LED Dimmable with: Dimmable bulbs Made of: Metallized Polycarbonate Weight: net Kg 0,70 - gross Kg 2,25 Package: 47,5 x 47,5 x h. 65,5 cm		 MIRROR / BLACK	SMOSM00MRB01T00000EU	€ 390,00
		 BLACK/GOLD	SMOSM00BGD01T00000EU	€ 390,00

CANOPY DETAILS



SUPERMORGANA

Ø 11 cm x h. 2,7 cm (Ø 4-1/4" x h. 1")

6m. cable kit must be ordered with lamp purchase
Kit Cavi da 6m da richiedere tassativamente in fase di ordine

Kit di installazione multipla su richiesta
Multiple installation kit on request

SUPERMORGANA ENTIRE COLLECTION



FINISHES



MIRROR
BLACK



GOLD
BLACK

TULIP SUSPENSION

by Marc Sadler

Compendium page 80

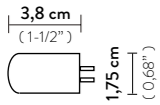
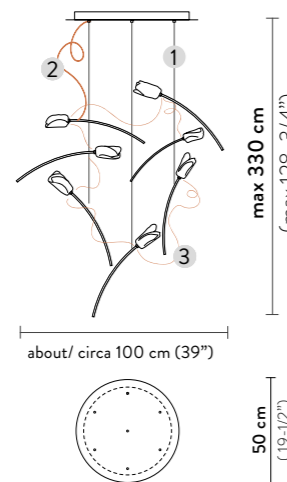
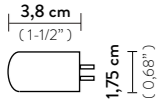
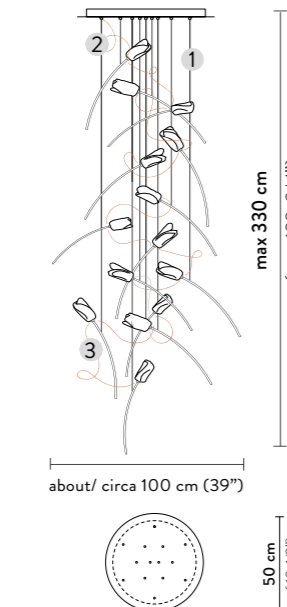
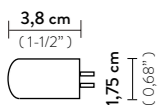
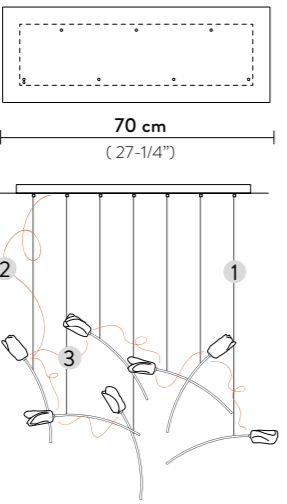
PRODUCT / PRODOTTO	DIMENSIONS / MISURE	COLOUR / COLORE	CODE / CODICE	PRICE VAT EXCL. PREZZO IVA ESCL.
TULIP 7 ROUND SUSPENSION Bulbs G4: 7 X 5W LED Dimmable Bulbs (included) 3500 Lumen - 2900 Kelvin  Power Supply: 110 ~220Vac / 24Vdc Dimmable with: PWM / 0-10 Made of: Lentiflex® / Matte Brushed Brass / Copper electric wires Weight: net 4,80 Kg – gross 6,40 kg Package: A 80 x 40,5 x 7,5 cm - 1,70 kg B 59 x 62 x 7,5 cm - 4,70 kg		PRISMA BRASS	TULSM00PRS03C00RNCEU	€ 1.630,00
<ol style="list-style-type: none"> ADJUSTABLE STEEL CABLE min 20 cm (7-3/4") max 300 cm (117") - 600 cm/234" upon request MAIN COPPER ELECTRIC WIRE max 300 cm (117") Max distance from one tulip to another (electric copper cable) of 80cm /31" Distanza max. fra un tulipano all'altro (cavo elettrico in rame) di 80cm 				
TULIP 14 ROUND SUSPENSION Bulbs G4: 14 X 5W LED Dimmable Bulbs (included) 7000 Lumen - 2900 Kelvin  Power Supply: 110 ~220Vac / 24Vdc Dimmable with: PWM / 0-10 Made of: Lentiflex® / Matte Brushed Brass / Copper electric wires Weight: net 6,05 Kg – gross 8,35kg Package: A 80 x 40,5 x 7,5 cm -1,70 kg B 80 x 40,5 x 7,5 cm -1,70 kg C 59 x 62 x 7,5 cm -4,95kg		PRISMA BRASS	TULSL00PRS03C00RNCEU	€ 2.860,00
<ol style="list-style-type: none"> ADJUSTABLE STEEL CABLE min 20 cm (7-3/4") max 300 cm (117") - 600 cm/234" upon request MAIN COPPER ELECTRIC WIRE max 300 cm (117") Max distance from one tulip to another (electric copper cable) of 80cm /31" Distanza max. fra un tulipano all'altro (cavo elettrico in rame) di 80cm 				
TULIP 7 LINEAR SUSPENSION Bulbs G4: 7 X 5W LED Dimmable Bulbs (included) 3500 Lumen - 2900 Kelvin  Power Supply: 110 ~220Vac / 24Vdc Dimmable with: PWM / 0-10 Made of: Lentiflex® / Matte Brushed Brass / Copper electric wires Weight: net 5,35 Kg – gross 6,75 kg Package: A 80 x 40,5 x 7,5 cm -1,70 kg B 80 x 40,5 x 7,5 cm -5,05 kg		PRISMA BRASS	TULSM00PRS03C00LNCEU	€ 1.630,00
<ol style="list-style-type: none"> ADJUSTABLE STEEL CABLE min 20 cm (7-3/4") max 300 cm (117") - 600 cm/234" upon request MAIN COPPER ELECTRIC WIRE max 300 cm (117") Max distance from one tulip to another (electric copper cable) of 80cm /31" Distanza max. fra un tulipano all'altro (cavo elettrico in rame) di 80cm 				

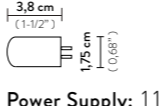
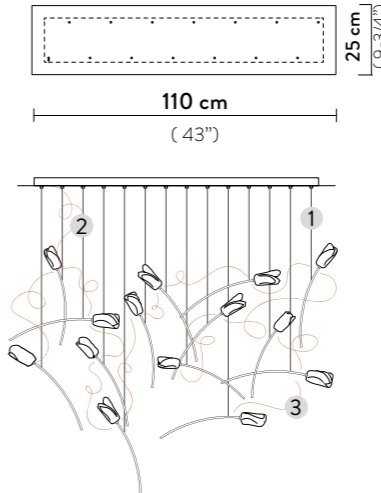
PRODUCT / PRODOTTO	DIMENSIONS / MISURE	COLOUR / COLORE	CODE / CODICE	PRICE VAT EXCL. PREZZO IVA ESCL.
TULIP 14 LINEAR SUSPENSION Bulbs G4: 14 X 5W LED Dimmable Bulbs (included) 3500 Lumen - 2900 Kelvin  Power Supply: 110 ~220Vac / 24Vdc Dimmable with: PWM / 0-10 Made of: Lentiflex® / Matte Brushed Brass / Copper electric wires Weight: net 8,55 Kg – gross 11,15 kg Package: A 80 x 40,5 x 7,5 cm -1,70 kg B 80 x 40,5 x 7,5 cm -1,70 kg C 122 x 34 x 7,5cm -7,75 kg		PRISMA BRASS	TULSL00PRS03C00LNCEU	€ 2.860,00
<ol style="list-style-type: none"> ADJUSTABLE STEEL CABLE min 20 cm (7-3/4") max 300 cm (117") - 600 cm/234" upon request MAIN COPPER ELECTRIC WIRE max 300 cm (117") Max distance from one tulip to another (electric copper cable) of 80cm /31" Distanza max. fra un tulipano all'altro (cavo elettrico in rame) di 80cm 				

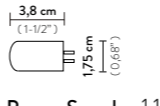
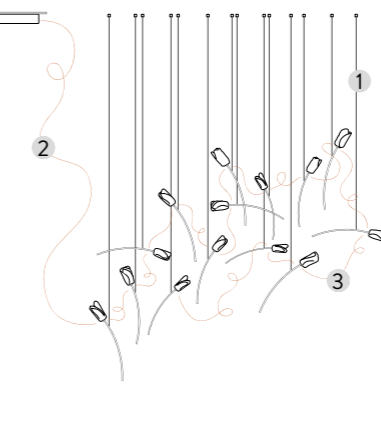
PRODUCT / PRODOTTO	DIMENSIONS / MISURE	COLOUR / COLORE	CODE / CODICE	PRICE VAT EXCL. PREZZO IVA ESCL.
TULIP 14 FREE-STANDING Bulbs G4: 14 X 5W LED Dimmable Bulbs (included) 7000 Lumen - 2900 Kelvin  Power Supply: 110 ~220Vac / 24Vdc Dimmable with: PWM / 0-10 Made of: Lentiflex® / Matte Brushed Brass / Copper electric wires Weight: net 4 Kg – gross 5,90 kg Package: A 80 x 40,5 x 7,5 cm - 1,70 kg B 80 x 40,5 x 7,5 cm -1,70 kg C 40 x 43 x 7,5 cm -2,50 Kg		PRISMA BRASS	TULSL00PRS03C00000EU	€ 2.450,00
<ol style="list-style-type: none"> ADJUSTABLE STEEL CABLE min 20 cm (7-3/4") max 300 cm (117") - 600 cm/234" upon request MAIN COPPER ELECTRIC WIRE max 300 cm (117") Max distance from one tulip to another (electric copper cable) of 80cm /31" Distanza max. fra un tulipano all'altro (cavo elettrico in rame) di 80cm 				

CANOPY DETAILS

 TULIP 7 / 14 ROUND Ø50 cm (Ø19-1/2") x h. 4,5 cm (1,75")	 TULIP 7 LINEAR 70 x 25 cm (24-1/4 x 9-3/4") x h. 4,5 cm (1,75")	 TULIP 14 LINEAR 110 x 25 cm (43 x 9-3/4") x h. 4,5 cm (1,75")	 FREE-STANDING Ø30 cm x h. 4,5 cm (Ø11,7 x 1,75)	
--	---	---	--	---

TULIP ENTIRE COLLECTION

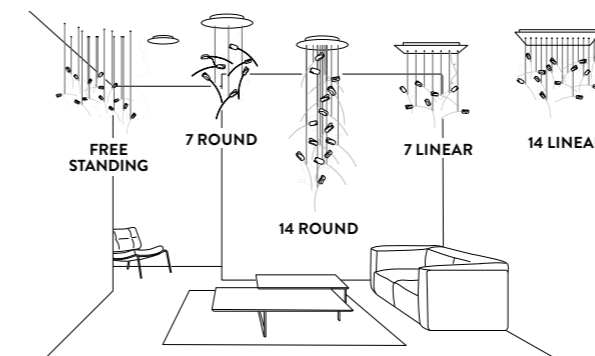

FINISHES



PRISMA AND BRASS

THE LIGHTNING ARCHIVES of Studio Job

Compendium page 470

PRODUCT / PRODOTTO	DIMENSIONS / MISURE	COLOUR / COLORE	CODE / CODICE	PRICE VAT EXCL. / PREZZO IVA ESCL.
FLOOR XL Bulbs E27: 3 X 12W LED Filament Dimmable with: Dimmable bulbs Made of: Opalflex® - Cristalflex® With: Dimmer / Brass or Coloured finish profiles Weight: net Kg 2 - gross Kg 6,00 Package: 28 x 37 x h. 168 cm		LABYRINTH	TUBFXL0LBR00000000EU	€ 860,00
		LOVE PEACE JOY	TUBFXL0LVJ00000000EU	€ 860,00
		PERISHED	TUBFXL0PRH00000000EU	€ 860,00
		BANANAS	TUBFXL0BAN00000000EU	€ 860,00
		FAENA ART	TUBFXL0FAR00000000EU	€ 860,00
		L'AFRIQUE	TUBFXL0AFQ00000000EU	€ 860,00
		PEACE SKULL	TUBFXL0PSK00000000EU	€ 860,00

WOODY design by Luca Mazza

Compendium pages 230

PRODUCT / PRODOTTO	DIMENSIONS / MISURE	COLOUR / COLORE	CODE / CODICE	PRICE VAT EXCL. / PREZZO IVA ESCL.
SUSPENSION Bulbs E27: 1 X 12W LED Filament Dimmable with: Dimmable bulbs Made of: Polycarbonate / Wood Weight: net Kg 0,56 - gross Kg 1,5 Package: 45 x 45 x h. 43 cm		<input type="checkbox"/> WHITE	WOOSM00WHT01T00000EU	€ 340,00
		<input type="checkbox"/> PURPLE	WOOSM00PRP01T00000EU	€ 340,00
		<input type="checkbox"/> ORANGE	WOOSM00ORG01T00000EU	€ 340,00
		<input type="checkbox"/> BLUE	WOOSM00BLU01T00000EU	€ 340,00

THE LIGHTNING ARCHIVES ENTIRE COLLECTION

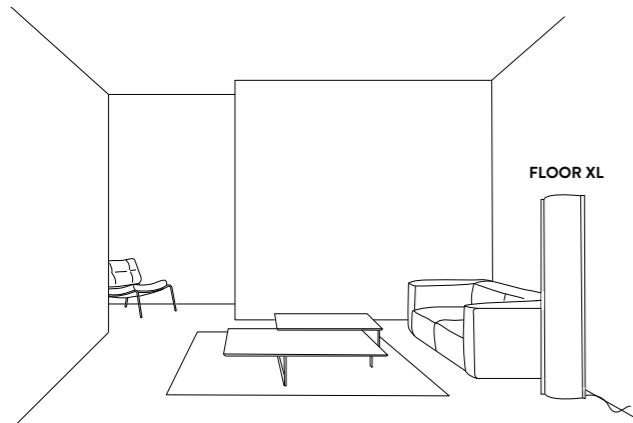

FINISHES



LABYRINTH LOVE PEACE JOY PERISHED BANANAS FAENA ART L'AFRIQUE PEACE SKULL

WOODY ENTIRE COLLECTION

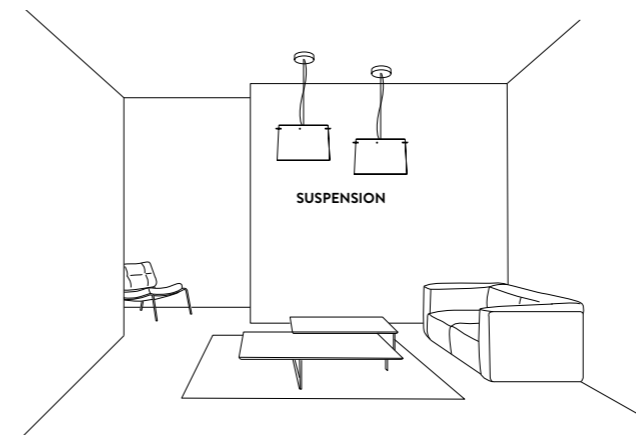

FINISHES

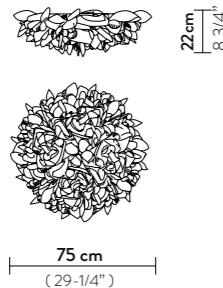
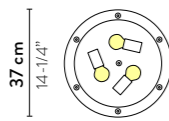
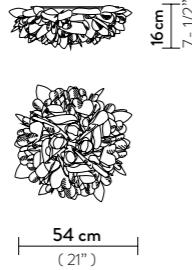
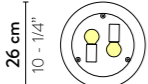
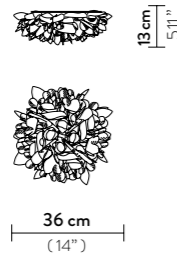
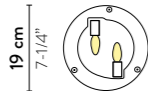

WHITE PURPLE ORANGE BLUE

PRODUCT / PRODOTTO	DIMENSIONS / MISURE	COLOUR / COLORE	CODE / CODICE	PRICE VAT EXCL. / PREZZO IVA ESCL.
CEILING / WALL LARGE Bulbs E27: 3 X 12W LED Filament Dimmable with: Dimmable bulbs Made of: Opalflex® With: MagneticSystem® Weight: net Kg 3,09 - gross Kg 7,6 Package: 80 x 80 x h. 30 cm	 <p>75 cm (29-1/4")</p> <p>22 cm 8 3/4"</p> <p>LIGHT SOURCE:</p>  <p>37 cm 14-1/4"</p>	FOLIAGE	VELCLO0FLG00000000EU	€ 450,00
CEILING / WALL MEDIUM Bulbs E27: 2 X 12W LED Filament Dimmable with: Dimmable bulbs Made of: Opalflex® With: MagneticSystem® Weight: net Kg 1,25 - gross Kg 2,6 Package: 55 x 57 x h. 23 cm	 <p>54 cm (21")</p> <p>16 cm 7-1/2"</p> <p>LIGHT SOURCE:</p>  <p>26 cm 10-1/4"</p>	FOLIAGE	VELCM00FLG00000000EU	€ 270,00
CEILING / WALL MINI Bulbs E14: 2 X 6W LED Filament Dimmable with: Dimmable bulbs Made of: Opalflex® With: MagneticSystem® Weight: net Kg 0,61 - gross Kg 1,05 Package: 36 x 38 x h. 15 cm	 <p>36 cm (14")</p> <p>13 cm 5 1/8"</p> <p>LIGHT SOURCE:</p>  <p>19 cm 7-1/4"</p>	FOLIAGE	VELCS00FLG00000000EU	€ 198,00

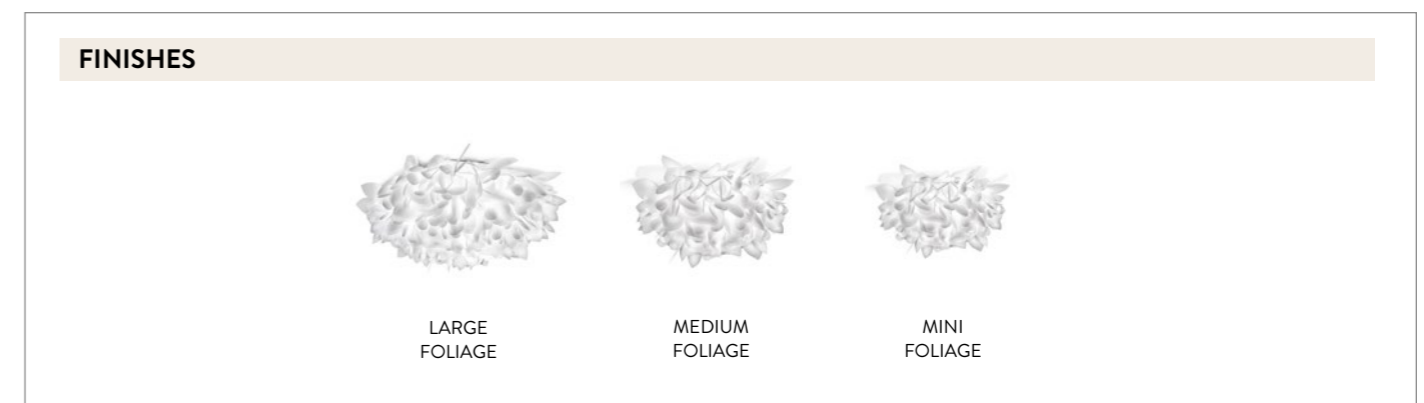
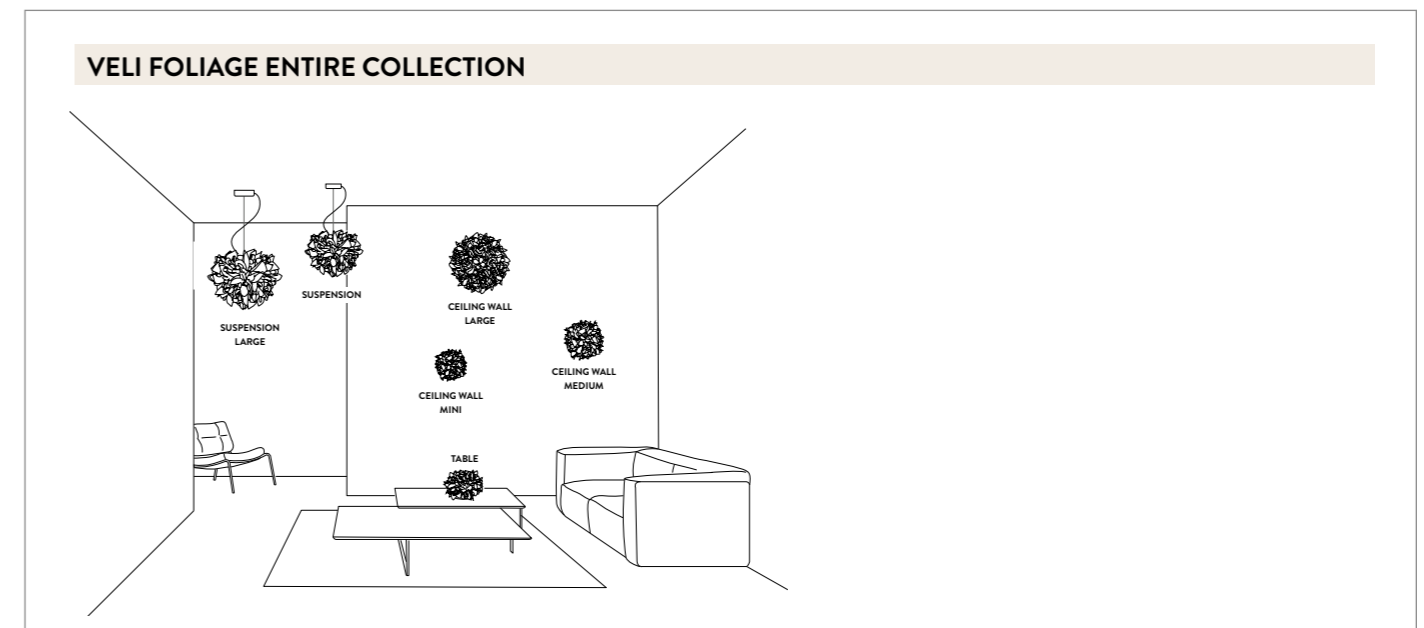

VELI SUSPENSION FOLIAGE by Adriano Rachele

Compendium page 182

PRODUCT / PRODOTTO	DIMENSIONS / MISURE	COLOUR / COLORE	CODE / CODICE	PRICE VAT EXCL / PREZZO IVA ESCL
SUSPENSION LARGE Bulbs E27: 4 X 12W LED Filament Dimmable with: Dimmable bulbs Made of: Opalflex® With: Magnetic System® Weight: net Kg 2,07 - gross Kg 5,7 Package: 61 x 61 x h. 64 cm		FOLIAGE RED WIRE	VELSL00FLG01R00000EU	€ 420,00
		FOLIAGE TRSP. WIRE	VELSL00FLG01T00000EU	€ 420,00
SUSPENSION Bulbs E27: 2 X 12W LED Filament Dimmable with: Dimmable bulbs Made of: Opalflex® With: Magnetic System® Weight: net Kg 1,15 - gross Kg 2,6 Package: 55 x 57 x h. 23 cm		FOLIAGE RED WIRE	VELSS00FLG01R00000EU	€ 290,00
		FOLIAGE TRSP. WIRE	VELSS00FLG01T00000EU	€ 290,00

CANOPY DETAILS



VELI FOLIAGE

LARGE- MEDIUM: Ø 12 cm x h. 3,2 cm (Ø 4-3/4" x h. 1-1/4")

Red wrapped electric wire - Available also with transparent cable
 Cavo calzato rosso - Disponibile anche con cavo trasparente

6m. cable kit must be ordered with lamp purchase
 Kit Cavi da 6m da richiedere tassativamente in fase di ordine

Kit di installazione multipla su richiesta
 Multiple installation kit on request

FINISHES

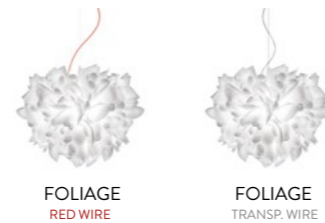

VELI TABLE Ø32 FOLIAGE by Adriano Rachele

Compendium page 360

PRODUCT / PRODOTTO	DIMENSIONS / MISURE	COLOUR / COLORE	CODE / CODICE	PRICE VAT EXCL / PREZZO IVA ESCL
TABLE Bulbs E14: 1X 6W LED Filament Made of: Opalflex® / Metacrylate base With: Magnetic System® Weight: net Kg 0,6 - gross Kg 1,2 Package: 32 x 34 x h. 22 cm		FOLIAGE	VELTS00FLG00000000EU	€ 210,00

VELI FOLIAGE ENTIRE COLLECTION

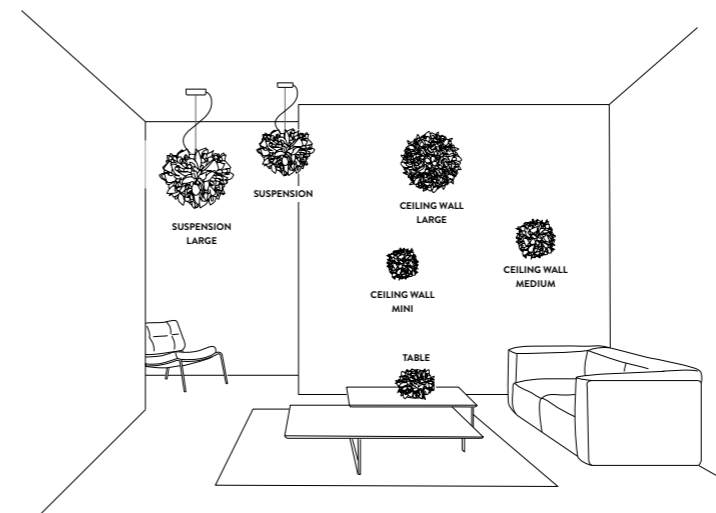

FINISHES



VELI CEILING / WALL by Adriano Rachele

Compendium pages **278 / 272 / 428**
276 / 434 / 274 / 432 / 430

PRODUCT / PRODOTTO	DIMENSIONS / MISURE	COLOUR / COLORE	CODE / CODICE	PRICE VAT EXCL. / PREZZO IVA ESCL.
CEILING / WALL LARGE Bulbs E27: 3 X 12W LED Filament Dimmable with: Dimmable bulbs Made of: Opalflex® / Lentiflex® / Goldflex® / Steelflex® / Copperflex® With: MagneticSystem® Weight: net Kg 3,09 - gross Kg 7,6 Package: 80 x 80 x h. 30 cm		<input type="checkbox"/> OPAL	VELCL00WHT00000000EU	€ 410,00
		<input checked="" type="checkbox"/> PLUM	VELCL00PRP00000000EU	€ 410,00
		<input type="checkbox"/> CHARCOAL	VELCL00BLK00000000EU	€ 410,00
		<input type="checkbox"/> COUTURE	VELCL00CTR00000000EU	€ 450,00
		<input type="checkbox"/> PRISMA	VELCL00PRS00000000EU	€ 510,00
		<input type="checkbox"/> SILVER	VELCL00SLV00000000EU	€ 620,00
CEILING / WALL MEDIUM Bulbs E27: 2 X 12W LED Filament Dimmable with: Dimmable bulbs Made of: Opalflex® / Lentiflex® / Goldflex® / Steelflex® / Copperflex® With: MagneticSystem® Weight: net Kg 1,25 - gross Kg 2,6 Package: 55 x 57 x h. 23 cm		<input type="checkbox"/> OPAL	VELCM00WHT00000000EU	€ 240,00
		<input checked="" type="checkbox"/> PLUM	VELCM00PRP00000000EU	€ 240,00
		<input type="checkbox"/> CHARCOAL	VELCM00BLK00000000EU	€ 240,00
		<input checked="" type="checkbox"/> CHILLI	VELCM00RED00000000EU	€ 240,00
		<input type="checkbox"/> COUTURE	VELCM00CTR00000000EU	€ 270,00
		<input type="checkbox"/> PRISMA	VELCM00PRS00000000EU	€ 270,00
CEILING / WALL MINI Bulbs E14: 2 X 6W LED Filament Dimmable with: Dimmable bulbs Made of: Opalflex® / Lentiflex® / Goldflex® / Steelflex® / Copperflex® With: MagneticSystem® Weight: net Kg 0,61 - gross Kg 1,05 Package: 36 x 38 x h. 15 cm		<input type="checkbox"/> OPAL	VELCS00WHT00000000EU	€ 180,00
		<input checked="" type="checkbox"/> PLUM	VELCS00PRP00000000EU	€ 180,00
		<input type="checkbox"/> CHARCOAL	VELCS00BLK00000000EU	€ 180,00
		<input type="checkbox"/> COUTURE	VELCS00CTR00000000EU	€ 198,00
		<input type="checkbox"/> PRISMA	VELCS00PRS00000000EU	€ 198,00
		<input type="checkbox"/> SILVER	VELCS00SLV00000000EU	€ 229,00
<input checked="" type="checkbox"/> COPPER	VELCS00CPP00000000EU	€ 229,00		
<input type="checkbox"/> GOLD	VELCS00GLD00000000EU	€ 229,00		

VELI ENTIRE COLLECTION

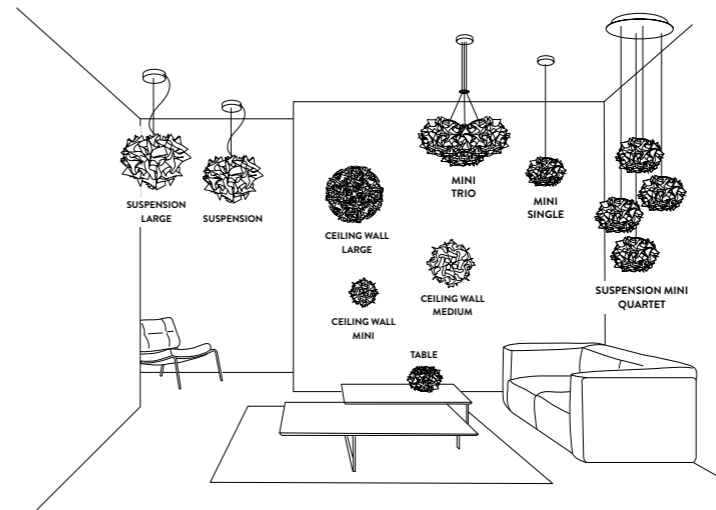

FINISHES



VELI SUSPENSION by Adriano Rachele

Compendium page 190 / 192 / 194 / 186

PRODUCT / PRODOTTO	DIMENSIONS / MISURE	COLOUR / COLORE	CODE / CODICE	PRICE VAT EXCL PREZZO IVA ESCL.
SUSPENSION LARGE Bulbs E27: 4 X 12W LED Filament Dimmable with: Dimmable bulbs Made of: Opalflex® / Lentiflex® / Goldflex® / Steelflex® / Copperflex® With: Magnetic System® Weight: net Kg 2,07 - gross Kg 5,7 Package: 61 x 61 x h. 64 cm	<p>20-140 cm min 8" max 55" 50 cm (19-3/4") 60 cm (23-3/4")</p> <p>LIGHT SOURCE:</p> <p>BOTTOM VIEW</p>	■ OPAL	VELSL00WHT01T00000EU	€ 380,00
		■ PLUM	VELSL00PRP01T00000EU	€ 380,00
		■ CHARCOAL	VELSL00BLK01T00000EU	€ 380,00
		■ COUTURE RED WIRE	VELSL00CTR01R00000EU	€ 420,00
		■ COUTURE TRSP. WIRE	VELSL00CTR01T00000EU	€ 420,00
		■ PRISMA	VELSL00PRS01T00000EU	€ 420,00
		■ SILVER	VELSL00SLV01T00000EU	€ 690,00
		■ COPPER	VELSL00CPP01T00000EU	€ 690,00
		■ GOLD	VELSL00GLD01T00000EU	€ 690,00
		SUSPENSION Bulbs E27: 2 X 12W LED Filament Dimmable with: Dimmable bulbs Made of: Opalflex® / Lentiflex® / Goldflex® / Steelflex® / Copperflex® With: Magnetic System® Weight: net Kg 1,15 - gross Kg 2,6 Package: 55 x 57 x h. 23 cm	<p>20-140 cm min 8" max 55" 36 cm (14-1/4") 42 cm (16-1/2")</p> <p>LIGHT SOURCE:</p> <p>BOTTOM VIEW</p>	■ OPAL
■ PLUM	VELSS00PRP01T00000EU			€ 260,00
■ CHARCOAL	VELSS00BLK01T00000EU			€ 260,00
■ COUTURE RED WIRE	VELSS00CTR01R00000EU			€ 290,00
■ COUTURE TRSP. WIRE	VELSS00CTR01T00000EU			€ 290,00
■ PRISMA	VELSS00PRS01T00000EU			€ 290,00
■ SILVER	VELSS00SLV01T00000EU			€ 410,00
■ COPPER	VELSS00CPP01T00000EU			€ 410,00
■ GOLD	VELSS00GLD01T00000EU			€ 410,00

CANOPY DETAILS

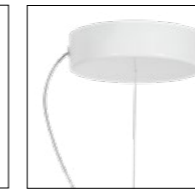

VELI COUTURE

LARGE- MEDIUM: Ø 12 cm x h. 3,2 cm (Ø 4-3/4" x h. 1-1/4")

Red wrapped electric wire - Available also with transparent cable
Cavo calzato rosso - Disponibile anche con cavo trasparente

6m. cable kit must be ordered with lamp purchase
Kit Cavi da 6m da richiedere tassativamente in fase di ordine

Kit di installazione multipla su richiesta
Multiple installation kit on request



VELI OPAL / PLUM / CHARCOAL / PRISMA GOLD / SILVER / COPPER

LARGE Ø 12 cm x h. 6 cm (Ø 4-3/4" x h. 2-1/4")

MEDIUM: Ø 10 cm x h. 5,5 cm (Ø 4" x h. 2")

6m. cable kit must be ordered with lamp purchase
Kit Cavi da 6m da richiedere tassativamente in fase di ordine

Kit di installazione multipla su richiesta
Multiple installation kit on request

OPAL / PLUM / CHARCOAL
PRISMA / GOLD / SILVER
COPPER VERSION

VELI ENTIRE COLLECTION

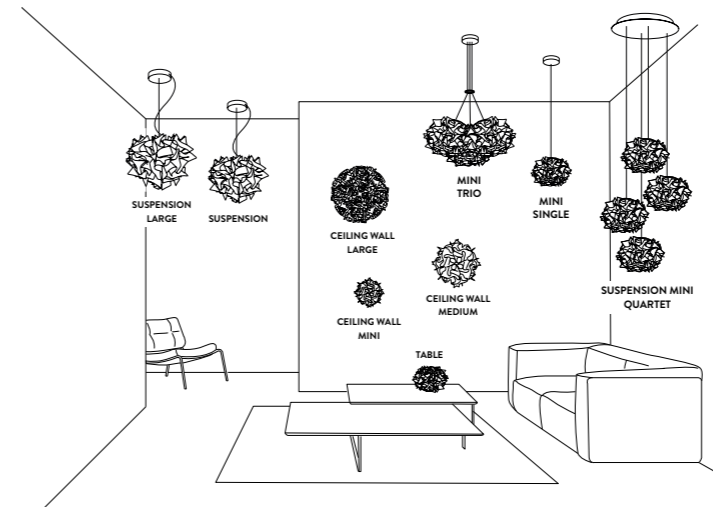

FINISHES



COUTURE
RED WIRE



COUTURE
TRANSP. WIRE



OPAL



PLUM



CHARCOAL



PRISMA



GOLD



SILVER





COPPER

VELI MINI SUSPENSION

by Adriano Rachele

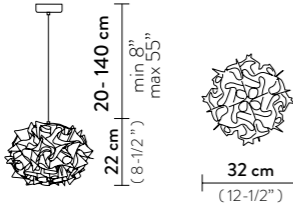
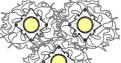
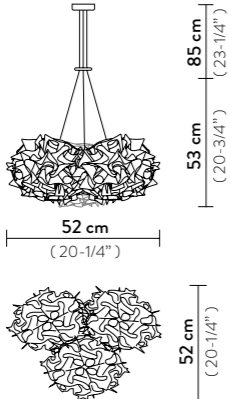
Compendium page **188**

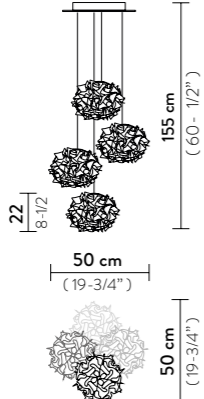
PRODUCT / PRODOTTO	DIMENSIONS / MISURE	COLOUR / COLORE	CODE / CODICE	PRICE VAT EXCL PREZZO IVA ESCL.
MINI SINGLE SUSPENSION Bulbs E27: 1 X 12W LED Filament Dimmable with: Dimmable bulbs Made of: Opalflex® With: Magnetic System® Weight: net Kg 0,6 - gross Kg 1,2 Package: 32 x 32 x h. 25 cm LIGHT SOURCE:  BOTTOM VIEW		<input type="checkbox"/> COUTURE RED WIRE	VELSXS0CTR01RMS000EU	€ 210,00
		<input type="checkbox"/> COUTURE TRSP. WIRE	VELSXS0CTR01TMS000EU	€ 210,00
MINI TRIO SUSPENSION Bulbs E27: 3 X 12W LED Filament Dimmable with: Dimmable bulbs Made of: Opalflex® With: Magnetic System® Weight: net Kg 1,6 - gross Kg 5 Package: 64 x 62 x h. 34 cm LIGHT SOURCE:  BOTTOM VIEW		<input type="checkbox"/> COUTURE RED WIRE	VELSM00CTR01RMT000EU	€ 580,00
		<input type="checkbox"/> COUTURE TRSP. WIRE	VELSM00CTR01TMT000EU	€ 580,00
MINI QUARTET SUSPENSION Bulbs E27: 4 X 12W LED Filament Dimmable with: Dimmable bulbs Made of: Opalflex® With: Magnetic System® Weight: net Kg 2 - gross Kg 5 Package: 64 x 62 x h. 34 cm LIGHT SOURCE:  BOTTOM VIEW		<input type="checkbox"/> COUTURE RED WIRE	VELSM00CTR01RMQ000EU	€ 830,00
		<input type="checkbox"/> COUTURE TRSP. WIRE	VELSM00CTR01TMQ000EU	€ 830,00

CANOPY DETAILS



VELI MINI SINGLE COUTURE Ø 12 cm x h. 3,2 cm (Ø 4-3/4" x h. 1-1/4")

VELI MINI TRIO COUTURE Ø 14 cm x h. 3 cm (Ø 5-1/2" x h. 1")

VELI MINI QUARTET COUTURE Ø 31,5 / 27,5 cm x h. 3,2 cm (Ø 12-1/4" / 10 3/4" x h. 1-1/4")

Red wrapped electric wire - Available also with transparent cable
 Cavo calzato rosso - Disponibile anche con cavo trasparente

6m. cable kit must be ordered with lamp purchase
 Kit Cavi da 6m da richiedere tassativamente in fase di ordine

Kit di installazione multipla su richiesta
 Multiple installation kit on request

VELI ENTIRE COLLECTION

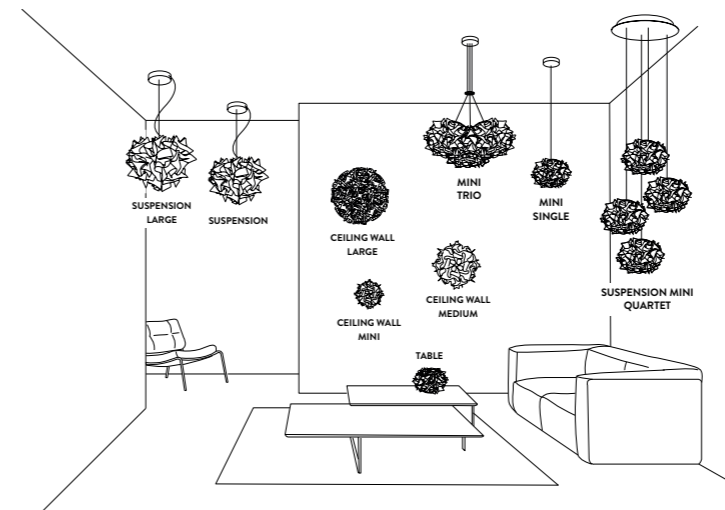

FINISHES



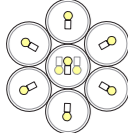
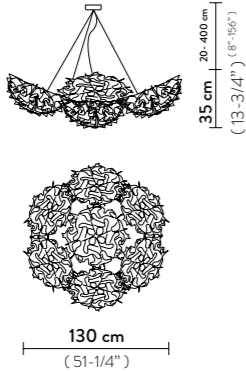

VELI 7 SUSPENSION by Adriano Rachele

Compendium page 198

PRODUCT / PRODOTTO	DIMENSIONS / MISURE	COLOUR / COLORE	CODE / CODICE	PRICE VAT EXCL. / PREZZO IVA ESCL.	
7 SUSPENSION Bulbs E27:  9X 12W LED Filament Dimmable with: Dimmable bulbs Made of: Opalflex® Weight: net Kg 12,65 - gross Kg 27,60 Package: A 61 x 49 x h. 51 cm B 55 x 57 x h. 23 cm (x7) LIGHT SOURCE:  BOTTOM VIEW		<input type="checkbox"/> OPAL	VELSOVSWHT04T000000EU	€ 2.100,00	
		<input type="checkbox"/> PLUM	VELSOVSPRP04T000000EU	€ 2.100,00	
		<input type="checkbox"/> CHARCOAL	VELSOVSBLK04T000000EU	€ 2.100,00	
		<input type="checkbox"/> CHILLI	VELSOVSRED04T000000EU	€ 2.100,00	
		<input type="checkbox"/> COUTURE TRSP. WIRE	VELSOVSTR04T000000EU	€ 2.500,00	
		<input type="checkbox"/> FOLIAGE TRSP. WIRE	VELSOVSFLG04T000000EU	€ 2.500,00	
		<input type="checkbox"/> PRISMA	VELSOVSPRS04T000000EU	€ 2.500,00	
		<input type="checkbox"/> SILVER	VELSOVSSLV04T000000EU	€ 2.990,00	
		<input type="checkbox"/> COPPER	VELSOVSCP04T000000EU	€ 2.990,00	
		<input type="checkbox"/> GOLD	VELSOVGLD04T000000EU	€ 2.990,00	

VELI TABLE Ø32 design by Adriano Rachele

Compendium page 362

PRODUCT / PRODOTTO	DIMENSIONS / MISURE	COLOUR / COLORE	CODE / CODICE	PRICE VAT EXCL. / PREZZO IVA ESCL.
TABLE Bulbs E14:  1X 6W LED Filament Made of: Opalflex® / Metacrylate base With: MagneticSystem® Weight: net Kg 0,6 - gross Kg 1,2 Package: 32 x 34 x h. 22 cm		<input type="checkbox"/> OPAL	VELTS00WHT0000000000EU	€ 190,00
		<input type="checkbox"/> PLUM	VELTS00PRP0000000000EU	€ 190,00
		<input type="checkbox"/> CHARCOAL	VELTS00BLK0000000000EU	€ 190,00
		<input type="checkbox"/> COUTURE	VELTS00CTR0000000000EU	€ 210,00

CANOPY DETAILS



VELI 7

Ø 14 cm x h. 3 cm (Ø 5-1/2" x h. 1")

6m. cable kit must be ordered with lamp purchase
 Kit Cavi da 6m da richiedere tassativamente in fase di ordine

VELI 7 ENTIRE COLLECTION

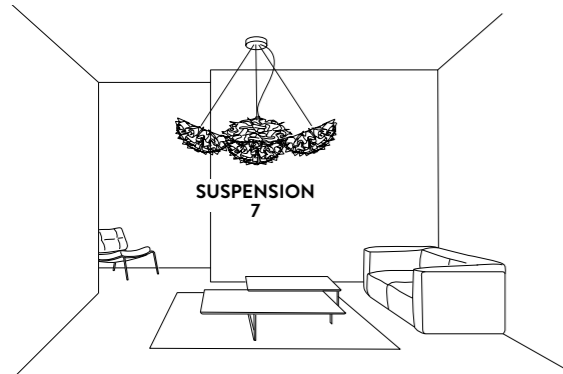

FINISHES



VELI ENTIRE COLLECTION

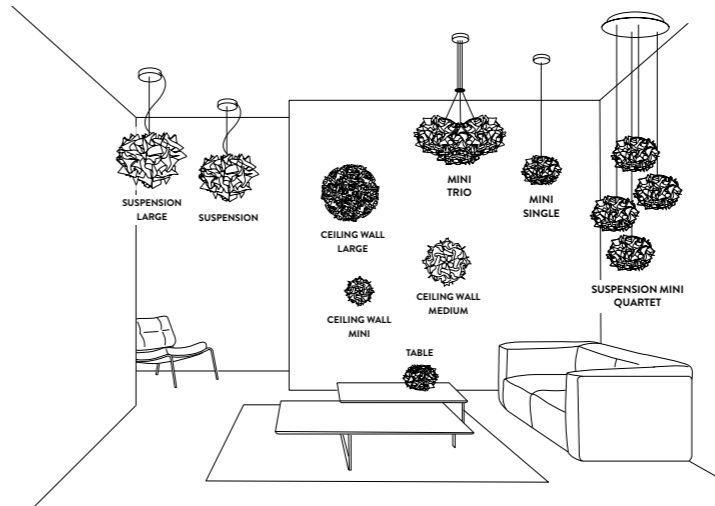

FINISHES

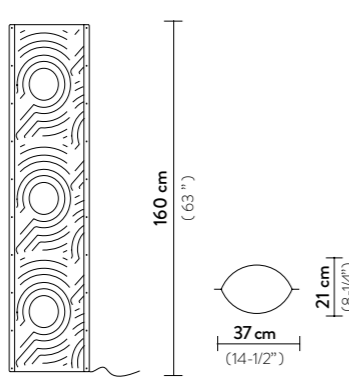
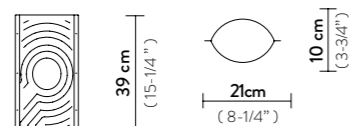

PRODUCT / PRODOTTO	DIMENSIONS / MISURE	COLOUR / COLORE	CODE / CODICE	PRICE VAT EXCL. / PREZZO IVA ESCL.
FLOOR LAMP Bulbs E27: 3 X 12W LED Filament Dimmable with: Dimmable bulbs Made of: Opalflex® With: Dimmer Included Aluminium profiles Weight: net Kg 2,80 - gross Kg 6,00 Package: 37 x 28 x h. 168 cm		<input type="checkbox"/> HYPERWHITE	TUBFXLOVEN00000000EU	€ 490,00
TABLE LAMP Bulbs E14: 1 X 6W LED Filament Made of: Opalflex® Weight: net Kg 0,40 - gross Kg 0,70 Package: 26 x 6 x h. 43 cm		<input type="checkbox"/> HYPERWHITE	TUBTS00VEN00000000EU	€ 130,00

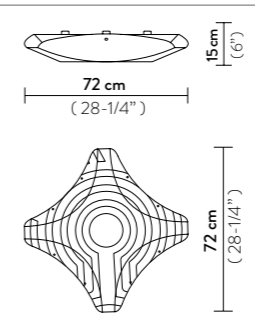
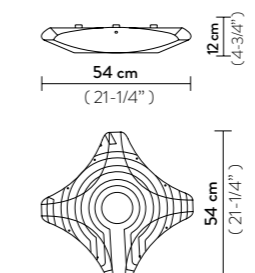
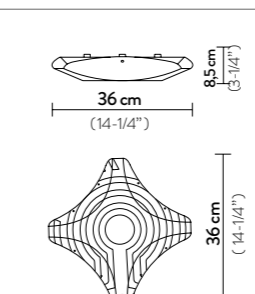
PRODUCT / PRODOTTO	DIMENSIONS / MISURE	COLOUR / COLORE	CODE / CODICE	PRICE VAT EXCL. / PREZZO IVA ESCL.
CEILING WALL LAMP LARGE Bulbs E27: 4 X 12W LED Filament Dimmable with: Dimmable bulbs Made of: Opalflex® With: MagneticSystem® Weight: net Kg 3,00 - gross Kg 5,50 Package: 80 x 80 x h. 25 cm		<input type="checkbox"/> HYPERWHITE	VENCL00WHT00000000EU	€ 320,00
CEILING WALL LAMP MEDIUM Bulbs E27: 3 X 12W LED Filament Dimmable with: Dimmable bulbs Made of: Opalflex® With: MagneticSystem® Weight: net Kg 2,00 - gross Kg 3,00 Package: 54,5 x 14 x h. 56 cm		<input type="checkbox"/> HYPERWHITE	VENCM00WHT00000000EU	€ 220,00
CEILING WALL LAMP SMALL Bulbs E27: 2 X 12W LED Filament Dimmable with: Dimmable bulbs Made of: Opalflex® With: MagneticSystem® Weight: net Kg 0,60 - gross Kg 1,00 Package: 39 x 36 x h. 9,5 cm		<input type="checkbox"/> HYPERWHITE	VENCS00WHT00000000EU	€ 160,00

VENTI ENTIRE COLLECTION

FINISHES

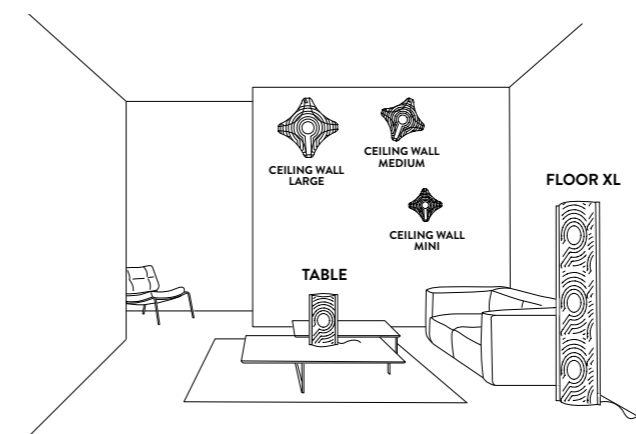

WHITE

from LAMPS TO beehives

SLAMP'S SUSTAINABLE PROJECT

The quality of Slamp's materials and their sustainable approach to working with them has set the company apart since 1994. Their resistant, long-lasting technopolymers not only exhibit optimal thermal, electrical, and chemical properties, but these unique materials are recyclable. The manufacturing processes have a low impact on the environment: the lamps' technopolymer sheets undergo cold cutting before being constructed by hand. The small amount of extra cuttings are recycled monthly, and since the beginning of 2020, a portion of those are being made into beehives for bumblebees by DS-Group. Bumblebees, part of the Apidae family, are widely used in pollinating fruit trees (replacing toxic chemicals). They are used for tomatoes as well, and ensure quality, juicy crops. Slamp applied the same approach to their headquarters, inaugurated September 8, 2019. High priority was placed on architectural decisions, including isolating thermal materials and large windows facing the production lines to reduce the use of artificial light. The hub's energy comes from predominantly renewable sources.

Per le qualità intrinseche dei materiali che impiega, e per le tecniche di lavorazione che utilizza, Slamp è un'azienda a basso impatto ambientale sin dal 1994. I tecnopolimeri, resistenti e durevoli, sono dotati di ottime proprietà termiche, elettriche e chimiche, e - soprattutto - sono riciclabili. I pochi sfridi di lavorazione generati durante la produzione vengono riciclati da sempre ma, dal 2020, parte di essi viene utilizzata anche per la produzione di componenti di arnie per i Bombi. Questa particolare tipologia di imenotteri è fondamentale per la tutela della biodiversità e permette l'impollinazione naturale di piante da frutto e ortaggi in alternativa a prodotti chimici altamente tossici. L'attenzione e la cura dell'ambiente hanno influito anche sull'architettura della sede di Slamp inaugurata nel 2019 alle porte di Roma: parte dell'energia assorbita dall'impianto produttivo arriva da fonti rinnovabili, l'hub produttivo è stato realizzato utilizzando materiali altamente isolanti e gli ampi lucernari sulle linee di allestimento riducono il consumo di luce artificiale.



SUSTAINABLE
PROCESSES

GENERAL SALES CONDITIONS

ALLGEMEINE VERKAUFSBEDINGUNGEN - CONDITIONS GENERALES DE VENTE - CONDICIONES GENERALES DE VENTAS

EN

This complete list replaces any other preexisting price list and sales conditions.

PRICING: The list's pricing is in euros.

FILLING ORDERS. All orders are to be filled according to current sales conditions. Slamp S.p.A. is under no obligation to fill received orders.

TERMS OF DELIVERY . The delivery terms expressed in order confirmations are indicative, and the company holds no responsibility for or compensation of delayed delivery as per the predicted terms of delivery.

SHIPPING. Returns: as per sales agreement

Merchandise shipped, even at no cost to the recipient, is the client's responsibility the moment it's entrusted to the carrier. As soon as merchandise is entrusted to the carrier, Slamp SpA will not be liable for any cause of delay.The client is required to carefully inspect the quantity and status of the shipment as indicated in delivery documentation. Any difference, including number of packages received and number of packages indicated in the delivery note, breakage, crushing, and/or other damage to packaging, must be reported to the carrier and Slamp S.p.A. (indicating the ddt number) on or before 8 days following merchandise delivery.

RETURNS. Returns for damage or flaws may be reported utilising the Post-Sales Assistance form available on Slamp's website, www.slamp.com, and must be reported within 8 days of delivery.

ON-LINE SALES. Products sold online, regardless of the source, must be authorised by Slamp S.p.A. through specific sales agreements and permission to use the Brand name and official images. In the absence of said permission, it is prohibited to sell Slamp products on-line.

RETURNS. Slamp does not accept returns without admitting written consent. Damage due to inappropriate handling and/or use of merchandise outside of its intended purpose is expressly not the company's responsibility.
<https://www.slamp.com/en/contacts/post-sale-assistance/>

TOLERANCE. Colours pictured in the catalogue are approximate. Client confirmation signifies acceptance of possible differences between the photography and products received. The products' technical sheets are the only testament to their true characteristics.

PAYMENT. Payment must be made according to the terms stated in the invoice, directly to our administrative offices. The failure to pay, in full or in part, an invoice or meet payment deadlines authorizes Slamp to suspend current production or shipment, as well as cancel contracts and seek damages incurred.

MODIFICATION. SLAMP S.p.A. retains the right to modify details concerning all products without warning or notice.

MAINTENANCE . Slamp's unique materials require specific maintenance; the company is not responsible for damage due to disregard of the following:

Lamp surfaces must be cleaned with a soft, damp cloth or using compressed air. Never use acetone, alcohol, ammonia, or other products with the same chemical properties, even in small doses. Also avoid powdered soap, abrasive pastes and rough-surface cleaning aids, including steel wool, and scouring pads and sponges.

WARRANTY. Slamp S.p.A. offers the minimum guarantee as stated in the current governing legislation at the time of purchase.

USE OF THE SLAMP BRAND AND LOGO. All provided images and the logo can only be used when presenting Slamp S.p.A. products in authorised locations. Please consult and follow our guidelines for using the Brand and logo, that cannot be changed or ignored for any reason.

PERSONAL DATA PROTECTION. The Company processes personal data as stated in the Privacy Information section found at the following link: <https://www.slamp.com/en/privacy-policy/>

LEGISLATIVE REACH. Italian legislation is applied to all aforementioned agreements, and any disagreement between the parties will be settled exclusively in the Tribunale di Velletri.

DE

Die vorliegende Preisliste ersetzt vollständig jede weitere schon bestehende Preisliste und alle vorherigen Lieferkonditionen.

PREISE. Die in dieser Preisliste angegebenen Preise sind in Euro ohne MwSt., Zoll, lokale Steuern und andere Abgaben.

ANNAHME. Alle Aufträge werden zu den aktuellen bestehenden allgemeinen Verkaufsbedingungen angenommen. Es wird ausdrücklich darauf hingewiesen, dass SLAMP SpA nicht verpflichtet ist, erhaltene Bestellungen anzunehmen.

LIEFERBEDINGUNGEN. Die in der Auftragsbestätigung aufgeführten Lieferfristen sind nur als Richtfristen zu verstehen. Es können keine Strafzahlungen oder Haftungen für verspätete Lieferungen gefordert werden.

LIEFERUNG . Rückgabe: gemäß allgemeinen Geschäftsvereinbarungen.

Die Waren werden, selbst wenn sie ab dem Empfänger versandt werden, auf Risiko und Gefahr des Kunden transportiert. Dies bedeutet, dass sie zum Zeitpunkt der Übergabe an den Spediteur geliefert wurden, und Slamp SpA haftet nicht für Verzögerungen, die nicht direkt darauf zurückzuführen sind.

Es liegt in der Verantwortung des Kunden, die Menge und den Zustand der Verpackung bei Lieferung sorgfältig zu überprüfen: Abweichungen (Differenz zwischen der Anzahl der erhaltenen Pakete und der auf dem Lieferschein angegebenen Anzahl von Paketen, Bruch, Knicke oder andere Beschädigungen an der Verpackung) sind dem Spediteur mit Vorbehalt auf dem Lieferschein anzugeben und spätestens 8 Tage nach Erhalt der Ware der SLAMP SpA mitzuteilen unter Angabe der Lieferscheinnummer.

REKLAMATIONEN. Reklamationen oder Mängel müssen innerhalb von 8 Tagen, ab Erhalt der Ware, über das Formular des Kundenservice, das sich auf der Homepage www.slamp.com befindet, gemeldet werden.

ONLINE-VERKÄUFE. Der Online-Verkauf von Produkten - über jedes denkbare System heute oder morgen - muss im Voraus von Slamp SpA durch Unterzeichnung spezifischer Wiederverkaufsvereinbarungen und das Recht zur Verwendung der Marke und der offiziellen Bilder genehmigt werden. Sofern nicht ausdrücklich von Slamp SpA genehmigt, ist es verboten, die Produkte online zu verkaufen.

RÜCKERSTATTUNG. Warenrücksendungen werden nicht angenommen, sofern dies nicht ausdrücklich schriftlich genehmigt wurde. Die Firma haftet nicht für Schäden an Produkten, die durch unsachgemäße und/ oder fremde Verwendung derselben entstehen.
<https://www.slamp.com/de/kontakte/kundendienst/>

TOLERANZ. Die im Fotokatalog sichtbaren Farben und Größen sind nur Richtwerte. Mit der Auftragsbestätigung akzeptiert der Kunde eventuelle Abweichungen zwischen den Fotos und dem erhaltenen Produkt. Für die Eigenschaften der Produkte gelten nur die technischen Datenblätter derselben.

ZAHLUNGEN. Zahlungen sind nur auf die in der Rechnung angegebene Weise an unser Büro zu senden. Der Ausfall oder die verspätete Zahlung oder Teilzahlung einer einzigen Rechnung oder Frist, berechtigt uns, die Ausführungen der Lieferungen einzustellen oder die Verträge mit dem Recht auf Schadensersatz zu kündigen. Die Zahlungsverzögerung führt auch zu einem Verlust der Laufzeit bei Zahlungsaufschub und Zinsbelastung gemäß der EG-Richtlinie 2000/35 und dem Gesetzesdekret 231/2002 und den nachfolgenden Änderungen. Die Ware bleibt Eigentum von SLAMP SpA bis zur vollständigen Bezahlung der Rechnung (Art. 1523-1526 des Zivilgesetzbuches).

VERÄNDERUNGEN. SLAMP S.p.A. behält sich das Recht vor, die Spezifikationen eines Produkts ohne vorherige Ankündigung zu ändern.

WARTUNG. Die Oberflächen der Leuchten müssen mit einem weichen, mit Wasser angefeuchteten Tuch, einem Antistatik-Tuch oder einem Druckluftspray gereinigt werden. Es ist unbedingt die Verwendung von Aceton, Alkohol, Trichlorethylen-Ammoniak oder andere Produkte, die diese Elemente enthalten, auch in kleinen Mengen zu vermeiden. Ebenfalls Pulverreiniger, Schleifpasten und Reinigungsmittel für raue Oberflächen wie Scheuerschwämme oder raue Schwämme sind nicht zu vermeiden. Metallteile – lackiert oder nicht - können mit einem feuchten Tuch gereinigt werden.

GARANTIE.Für die verkauften Produkte wendet Slamp SpA die Mindestgarantie an, die in den zum Zeitpunkt des Verkaufs geltenden Rechtsvorschriften vorgesehen ist.

VERWENDUNG DER SLAMP-MARKE UND DER LOGOS. Alle Fotos und das Logo, die Ihnen zur Verfügung gestellt werden, dürfen nur für die Präsentation von Slamp SpA-Produkten in den angegebenen und autorisierten Vorgaben verwendet werden. Wir bitten Sie, alle Anweisungen zur Verwendung unseres Logos oder unserer Marke zu befolgen, die Sie in keiner Weise aus irgendeinem Grund oder Titel unabhängig entsorgen können.

SCHUTZ PERSÖNLICHER DATEN . Das Unternehmen verarbeitet die personenbezogenen Daten des Käufers für die Zwecke und auf die Weise, die in den Datenschutzbestimmungen auf der Website unter dem Link <https://www.slamp.com/de/datenschutz/erklaerung/>

GERICHTSSTAND UND GESETZGEBUNG. Das italienische Recht gilt ausschließlich für diese Vereinbarungen, und für Streitigkeiten zwischen den Parteien jeglicher Art, muss das ausschließliche zuständige Gericht unter Ausschluss eines anderen durch ausdrückliche Vereinbarung zwischen den Parteien, dem des Gerichtshofs von Velletri, verstanden werden.

FR

Cette liste de prix remplace intégralement chaque liste de prix précédentes et les conditions générales de vente précédentes.

PRIX. Les prix indiqués sur cette liste de prix sont exprimés en euros.

ACCEPTATION. Toutes les commandes sont acceptées aux conditions générales de vente en vigueur. Il est expressément entendu que SLAMP SpA n'est pas obligée d'accepter les commandes reçues.

CONDITIONS DE LIVRAISON . Les délais de livraison indiqués dans la confirmation de commande ne sont qu'indicatifs. Aucune responsabilité ni indemnité ne sera due en cas de retard de livraison par rapport au délai prévu.

LIVRAISONS

• Retour: conformément aux accords commerciaux.

• Les marchandises, même envoyées gratuitement à destination, voyagent aux risques et périls du client, c'est-à-dire qu'elle est considérée comme livrée au moment où elle est confiée au transporteur.

• Il incombe au client de vérifier soigneusement la quantité et l'état de l'emballage au moment de la livraison: anomalies éventuelles (différence entre le nombre de colis reçus et le nombre de colis indiqué sur le bon de livraison, cassures, écrasements ou autres dommages à l'emballage, doit être indiqué au transporteur avec réserve sur le bordereau de livraison et communiqué à SLAMP SpA - en citant le numéro du bon de livraison - au plus tard 8 jours après la date de réception de la marchandise.

SAV. Les réclamations pour vices et / ou fautes doivent être notifiées via le formulaire d'Assistance après-vente sur le site www.slamp.com dans le délai impératif de 8 jours à compter de la réception de la marchandise.

VENTE EN LIGNE . La vente en ligne de produits - à travers tout système imaginable aujourd'hui ou demain - doit être préalablement autorisée par Slamp SpA en signant des accords de revente spécifiques et le droit d'utiliser la marque et les images officielles. Sauf autorisation expresse de Slamp SpA, il est interdit de vendre les produits en ligne.

RETOURS. Sauf autorisation écrite et préalable, les retours de marchandises ne sont pas acceptés. La société ne sera pas responsable des dommages aux produits résultant d'une utilisation inappropriée et / ou étrangère de ceux-ci.
<https://www.slamp.com/fr/contacts/service-apres-vente/>

TOLÉRANCE. Les couleurs et tailles visibles sur le catalogue photographique ne sont qu'indicatives. En confirmant la commande, le client accepte toute différence entre l'image et le produit reçu. Pour les caractéristiques des produits, seules les fiches techniques des mêmes sont valables.

REGLEMENTS. Les règlements doivent être envoyés uniquement à notre bureau de la manière indiquée sur la facture. Le non-paiement ou tout retard dans le paiement, même partiel, d'une facture ou d'une échéance nous autorise à suspendre l'exécution des fournitures en cours ou à les annuler avec faculté de remboursement des dommages subis. Le retard dans les paiements donnera également lieu au débit des intérêts conformément à la directive CE 2000/35 et au décret législatif 231/2002 et ses modifications ultérieures. Les marchandises restent propriété de SLAMP SpA jusqu'au paiement intégral de la facture (art. 1523-1526 du Code civil).

CHANGEMENTS. SLAMP SpA se réserve le droit de modifier les spécifications de tout produit sans préavis.

ENTRETIEN. Les surfaces des luminaires doivent être nettoyées avec un chiffon doux imbibé d'eau, un chiffon antistatique ou un spray d'air comprimé. Il est essentiel d'éviter l'acétone, l'alcool, le trichloréthylène ammoniac ou tout autre produit contenant ces éléments, même en petite quantité. Évitez également les détergents en poudre, les pâtes abrasives et les outils de nettoyage des surfaces rugueuses tels que les tampons à récurer ou les éponges rugueuses. Les pièces métalliques - naturelles et peintes - peuvent être nettoyées avec un chiffon humide.

GARANTIE Sur les produits vendus, Slamp SpA applique la garantie minimale prévue par la législation en vigueur au moment de la vente.

UTILISATION DE LA MARQUE ET DES LOGOS SLAMP Toutes les photos et le logo mis à votre disposition ne peuvent être utilisés que pour la présentation des produits Slamp SpA dans les locaux indiqués et autorisés. Nous vous demandons de suivre toutes les instructions d'utilisation de notre logo ou de notre marque, ce qui ne vous permettra en aucun cas d'en disposer de manière indépendante pour quelque raison ou titre que ce soit.

PROTECTION DES DONNÉES PERSONNELLES. La Société traite les données personnelles de l'acheteur aux fins et de la manière spécifiées dans la politique de confidentialité présente sur le site Web au lien <https://www.slamp.com/fr/declaration-de-politique-de-confidentialite/>

JURIDICTION ET LÉGISLATION. La loi italienne s'applique exclusivement à ces accords et pour tout litige entre les parties, de quelque nature que ce soit, le tribunal compétent exclusif, à l'exclusion de tout autre, doit être compris comme un accord exprès entre les parties, celui du tribunal de Velletri.

ES

Esta lista de precios substituye en todas sus partes a las previas listas de precios y relativas condiciones de ventas.

PRECIOS. Los precios en el listado siguiente están expresados en euros.

ACEPTACIÓN. Todos los pedidos serán aceptados según estas condiciones generales de ventas. Queda expresamente entendido que no existe ninguna obligación por parte de SLAMP SpA de aceptar los pedidos recibidos.

TÉRMINOS DE ENTREGA. Los términos de entrega indicados en la confirmación del pedido tienen carácter puramente orientativo. Ninguna responsabilidad ni compensación será imputable en caso de retraso en la fecha de entrega prevista.

ENVÍOS

• Devolución: según acuerdos comerciales

• Los bienes, aunque enviados franco destino, viajan con riesgo asumido por el cliente, en cuanto la entrega se realiza a la recogida por parte del transportista. Slamp SpA no será responsable de ningún retraso que no sea directamente imputable a ella misma.

• El cliente queda responsable de averiguar con atención la cantidad y el estado del embalaje: en caso de anomalías (diferencia entre el número de bultos recibidos y número de bultos indicados en el albarán; ruptura, aplastamiento y otro daño del embalaje), deberán ser señaladas al transportista y anotadas en el albarán, y comunicadas a SLAMP S.p.A - junto con el número de documento de transporte, a mas tardar 8 días tras la fecha de recepción de los bienes.

• Las reclamaciones por defectos y/o vicios deberán ser comunicadas por correo certificado dentro de 8 días desde la fecha de recepción de la mercancías en caso de defecto y/o vicio aparente, y a más tardar 8 días desde el descubrimiento de defecto y/o vicio oculto.

RECLAMACIONES Las reclamaciones por defectos o vicios se deben notificar en el formulario de asistencia post-venta en la página web www.slamp.com dentro del plazo perentorio de 8 días desde la entrega de los bienes.

VENTAS ONLINE. Las ventas online de los productos – efectuadas a través de cualquier sistema – deben ser previamente autorizadas por Slamp SpA suscribiendo los acuerdos de distribución y derechos de uso de la marca y de las imágenes oficiales. Sin la autorización de Slamp SpA, se prohíbe la venta online.

DEVOLUCIONES. No se aceptan devolución de bienes, si no estan expresamente autorizadas por escrito. La empresa no será responsable de daños a los productos debidos a uso inadecuado.
<https://www.slamp.com/es/contactos/asistencia-posventa/>

TOLERANCIAS. Los colores visibles en el catalogo tienen carácter puramente indicativo. Al confirmar el pedido el cliente acepta eventuales diferencias entre las imagines y el producto recibido. Para las características de los productos se considerarán únicamente las fichas técnicas de los mismos.

PAGOS. Los pagos deberán ser transmitidos unicamente a nuestra sede según las modalidades indicadas en factura. La falta o retraso de pago, aunque parcial nos autoriza a suspender el suministro de productos en curso o anular los contratos y pedir indemnización por eventuales daños sufridos. El retraso de pago dará lugar a la pérdida de beneficio en caso de pago diferido y al adeudo de los intereses con arreglo a la Directiva CE 2000/35 y al Decreto Ley 231/2002 y ss. La mercancía queda de propiedad de SLAMP SpA hasta el pago integral de la factura (arts. 1523 – 1526 del Código Civil Italiano)

MODIFICACIONES . SLAMP SpA se reserva el derecho de modificar sin previo aviso las específicas de cualquier producto.

MANUTENCIÓN. Para la limpieza de las superficies de las lamparas, utilizar un paño suave y humedecido con agua, o un pano antiestático o con aire comprimido. Evitar acetona, alcohol, tricloroetileno, amoniaco u otros productos que contengan dichas substancias, también en cantidad mínima. Evitar asimismo detergentes en polvo, pastas abrasivas y herramientas de limpieza con superficies abrasivas como estropajos o esponjas con lado áspero. Las partes de metal – tanto barnizado como natural – pueden ser limpiadas con un paño humedecido.

GARANTÍA. Slamp SpA, en los productos vendidos, aplicará la garantía mínima prevista por la legislación vigente en el momento de la venta.

UTILIZACIÓN DE LA MARCA Y DE LOS LOGOTIPOS DE SLAMP. Todas las fotos y el logotipo, a vuestra disposición, solo pueden utilizarse para la presentación de los productos de Slamp SpA, en los lugares indicados y autorizados. Los rogamos seguir todas las instrucciones de uso tanto de nuestro logotipo como de nuestra marca, en cuanto no se puede disponer autonomamente de ellos.

PROTECCIÓN DE LOS DATOS PERSONALES. La Empresa solo procesa los datos personales de los compradores en la medida necesaria y de conformidad con la informativa de privacidad disponible a este enlace <https://www.slamp.com/es/nota-informativa-sobre-la-privacidad/>

JURISDICCIÓN COMPETENTE Y LEY APLICABLE. Al siguiente acuerdo se aplicará exclusivamente la legislación italiana, y en caso de cualquier controversia que pudiese surgir entre las partes se acuerda que la jurisdicción competente será la del Tribunal de Velletri.

CONDIZIONI GENERALI DI VENDITA

Il presente listino sostituisce integralmente ogni listino prezzi precedente e le previgenti condizioni generali di vendita.

PREZZI. I prezzi riportati sul presente listino sono espressi in euro.

ACCETTAZIONE ORDINI. Tutti gli ordini vengono accettati alle condizioni generali di vendita in essere. Resta espressamente inteso che non sussiste alcun obbligo per Slamp SpA di accettare gli ordini ricevuti.

TERMINI DI CONSEGNA. I termini di consegna indicati nella conferma d'ordine hanno unicamente valore indicativo. Nessuna responsabilità sarà imputabile né risarcimento dovuto in caso di ritardo nella consegna rispetto al termine indicativo previsto.

SPEDIZIONI. Resa: come da accordi commerciali.

La merce, anche se spedita franco destinatario, viaggia a rischio e pericolo del cliente intendendosi la stessa consegnata al momento in cui viene affidata al vettore e la Slamp SpA non risponderà di alcuna causa di ritardo alla stessa non direttamente imputabile. È onere del cliente verificare con attenzione all'atto della consegna la quantità e lo stato degli imballi: eventuali anomalie (differenza fra numero di colli ricevuti e numero di colli indicati sul bollettino di consegna, o rottura, o schiacciamento o altro danno all'imballo), dovranno essere indicate al vettore con riserva sul bollettino di consegna, e comunicate a Slamp SpA - citando il numero di DDT - entro e non oltre 8 giorni dalla data di ricevimento della merce.

RECLAMI. Reclami per difetti e/o vizi devono essere notificati tramite il form di Assistenza Post-vendita sul sito www.slamp.com entro il termine perentorio di 8 gg dal ricevimento della merce.

VENDITE ON-LINE. La vendita online dei prodotti - attraverso qualunque sistema oggi o domani concepibile - deve essere preventivamente autorizzata da Slamp SpA tramite sottoscrizione di specifici accordi di rivendita e di diritto di utilizzo del marchio e delle immagini ufficiali. Se non espressamente autorizzato da Slamp SpA, è fatto divieto di vendere i prodotti on-line.

RESTITUZIONI. Non si accettano resi di merce, se non espressamente autorizzati per iscritto. La società non risponderà di danni ai prodotti derivati da un uso improprio e/o estraneo alla funzione e destinazione degli stessi.

TOLLERANZE. I colori e le dimensioni visibili sul catalogo fotografico sono soltanto indicativi. Confermando l'ordine il cliente accetta eventuali differenze fra immagine e il prodotto ricevuto. Per le caratteristiche dei prodotti fanno fede solamente le schede tecniche degli stessi.

PAGAMENTI. I pagamenti dovranno essere trasmessi unicamente alla nostra sede con le modalità indicate in fattura. Il mancato o ritardato pagamento anche parziale di una sola fattura o scadenza ci autorizza a sospendere l'esecuzione delle forniture in corso o annullare i contratti con facoltà di rivalsa dei danni subiti. Il ritardo nei pagamenti darà inoltre luogo alla perdita del beneficio del termine in caso di pagamenti dilazionati e all'addebito degli interessi in conformità alla Direttiva CE 2000/35 ed al D.Lgs. 231/2002 e ss. Le merci restano di proprietà della Slamp SpA fino al pagamento integrale della fattura (art. 1523-1526 del C.C.).

MODIFICHE. Slamp SpA si riserva il diritto di modificare senza preavviso le specifiche di qualsiasi prodotto.

MANUTENZIONE. Le superfici delle lampade devono essere pulite con un panno soffice inumidito con acqua, con un panno antistatico o con uno spray ad aria compressa. Evitare tassativamente acetone, alcool, trielina ammoniaca o altri prodotti che contengono questi elementi, anche in minima quantità. Evitare inoltre detergenti in polvere, paste abrasive e strumenti di pulizia con superficie ruvida quali pagliette o spugne ruvide. Le parti in metallo – sia naturali che verniciate – possono essere pulite con un panno inumidito.

GARANZIA. Sui prodotti venduti, Slamp SpA applica la garanzia minima prevista dalla legislazione vigente al momento della vendita.

UTILIZZO DEL MARCHIO E DEI LOGHI SLAMP. Tutte le foto e il logo, messi a vostra disposizione, possono essere utilizzati solo per la presentazione dei prodotti di Slamp SpA nei locali indicati ed autorizzati. Vi chiediamo di seguire tutte le istruzioni di utilizzo del nostro logo o marchio, dei quali in nessun modo potrete autonomamente disporre ad alcun titolo o ragione.

PROTEZIONE DEI DATI PERSONALI. La Società tratta i dati personali dell'acquirente per le finalità e con le modalità specificate nella Informativa sulla privacy presente sul sito Web al link www.slamp.com/it/informativa-privacy/

FORO COMPETENTE E LEGISLAZIONE. A questi accordi si applica esclusivamente la legislazione Italiana e per ogni controversia tra le parti, di qualsiasi natura, il foro esclusivamente competente, con esclusione di ogni altro, deve intendersi per patto espresso tra le parti, quello del Tribunale di Velletri.

SLAMP®

THE LEADING LIGHT

ALL SLAMP PRODUCTS ARE PRODUCED AND ASSEMBLED IN ITALY

WWW.SLAMP.IT

The company in this catalogue suggests the lightbulb wattage for an optimal balance of illumination and aesthetic output per product, as well as bulb size: E27/E26: Ø6 cm (2-1/4") E14/E12: Ø4,5cm (1-1/2"). Higher wattage can be used as long as the bulb is exclusively LED and matches the required size.

Il wattaggio delle lampadine sul seguente catalogo è suggerito dall'azienda per un ottimale balance fra resa luminosa ed estetica del prodotto oltre che alla dimensione del bulbo E27: Ø6 cm - E14: Ø4,5cm. Possono essere utilizzati wattaggi superiori purchè si utilizzino esclusivamente lampadine LED con una dimensione del bulbo adeguata.

Products are patented throughout the world and conform to the leading electrical safety standards. For any further info please ask your Slamp representative.

CE IP 20         CB REPORT AVAILABLE ON REQUEST

 All Slamp lamps are RAEE Standards compliant
Tutte le lampade Slamp sono conformi alla Normativa RAEE

SLAMP S.p.A. reserves the right to modify products without notice in the event of commercial conditions rendering this necessary. Slight differences of colour in some products in this catalogue are due to the processes involved in printing.

SLAMP S.p.A. si riserva il diritto di apportare modifiche ai prodotti senza alcun preavviso, qualora le condizioni commerciali lo rendessero necessario. Difformità di colore di alcuni prodotti sul presente catalogo sono dovute a processi di stampa.

HANDMADE IN ITALY

SLAMP:
THE LEADING LIGHT